

GUÍA IDENTIFICACIÓN DE MODELOS	102
GUÍA MANTENIMIENTO DE MOTORES	104
GUÍA MANTENIMIENTO TRANSMISIONES	108
KITS MANTENIMIENTO COLAS	108
MATERIALES GENÉRICOS PARA REVISIÓN	109

SISTEMA ALIMENTACIÓN Y FILTRACIÓN 110

GASOLINA	
FILTRO DE ACEITE	114
PARA DIRECCIÓN HIDRÁULICA AXIUS	114
GUÍA	115
FILTRO DE AIRE	113
FILTRO DE COMBUSTIBLE Y ELEMENTOS	110
BRACKET	110
FILTRO DECANTADOR, VASO TRASPARENTE	111
FILTRO EN LÍNEA	112
FILTRO PARA CARBURADOR	113
FILTRO SEPARADOR AGUA	110
FILTRO VST	113
RACOR DE LATÓN	112

DIESEL	
FILTRO DE ACEITE	121
GUÍA	122
FILTRO DE AIRE	120
FILTRO DE COMBUSTIBLE Y ELEMENTOS	116
FILTRO CON CAZOLETA	117
FILTRO DECANTADOR	118
FILTRO TIPO SEPAR2000	120
FILTRO TRANSMISION HURT	121

ACCESORIOS PARA FILTROS	123
BOMBA DE COMBUSTIBLE	124
BOMBA DE ALTA PRESIÓN	126
BOMBA DE BAJA PRESIÓN	127
BOMBA MECÁNICA	124
BOMBA Y ENFRIADOR	129
GUÍA BOMBAS MECÁNICAS	125
JUNTAS	125
JUNTAS VST	129
MÓDULO DE COMBUSTIBLE COMPLETO	128
REGULADORES PRESIÓN COMBUSTIBLE	129
CARBURADOR	132
APAGALLAMAS	142
BOYAS	136
CARBURADOR NUEVO	133
CARBURADOR REMANUFACTURADO	132
CHOKE	142
GUÍA	140
GUÍA KITS	139
JUNTAS	137
KIT ADAPTADORES	135
KIT AGUJA	136
TORNILLOS	136
TUBO COMBUSTIBLE, BOMBA --> CARBURADOR	135
INYECTORES	130
KIT RETENES INYECTOR	131
RACORES	122
TURBO	143
ABRAZADERA ESCAPE	143
KIT JUNTAS	143
RETÉN ACEITE	143

SISTEMA ELÉCTRICO 144

ALTERNADORES Y REGULADORES	153
KIT SUSTITUCIÓN ALTERNADOR	155
REGULADOR ALTERNADOR	155
MOTORES DE ARRANQUE	151
SENSORES	144
ÁRBOL DE LEVAS	146
CAUDAL DEL AGUA	148
GUÍA SENSORES	149
IAC	145
MAT/MAP	144
OXÍGENO	145
PICADO	145
PICK UP	145
POSICIÓN CIGÜEÑAL	146
PRESIÓN DE ACEITE	147
TEMPERATURA DEL AGUA	148
TEMPERATURA DE AIRE	148
TEMPERATURA ENFRIADOR	148

TEMPERATURA Y PRESIÓN ACEITE CON ALARMA	147
TPS	144
TRIM	146
VÁLVULA DE AIRE	145
SOLENOIDE, RELÉ Y FUSIBLES	157
ALARMA	160
EXTENSOR DE SOLENOIDE PARA TERMINALES	157
FUSIBLE ATM, ATC, MAXI	159
FUSIBLE MOTOR	158
FUSIBLE TERMINAL DE BATERÍA	159
FUSIBLE TRIM	158
INTERRUPTORES DE PARO	160
INTERRUPTORES TRIM	160
MERCATHODE	159
SOLENOIDES	157
SOLENOIDES ARRANQUE	157
SOLENOIDES DELCO REMY	157
SOLENOIDES TRIM	157
RELÉ	158
RELÉ DE ARRANQUE Y BOMBA GASOLINA	158
RELÉ PARA ACELERADOR Y EJE	158
RELÉ PARA ALARMA Y VARIOS	158
TRIM	155
CONVERTIDOR DE 3 A 2 CABLES	156
DEPÓSITO	156
SOPORTE	156
TRIM COMPLETO	155

SISTEMA ENCENDIDO 161

BOBINA ENCENDIDO	161
ENCENDIDO ELECTRÓNICO	161
BUJÍAS	163
CABLES ALTO RENDIMIENTO	167
DISTRIBUIDOR	168
CONDENSADORES	170
DESPIECES	173
• DELCO VOYAGER	173
• MPI V6 & V8	175
• THUNDERBOLT IV & V	174
DISTRIBUIDOR	175
DISTRIBUIDOR ELECTRÓNICO	176
GUÍA KITS DE CONVERSIÓN ELECTRÓNICO	172
GUÍA KITS DE ENCENDIDO	171
KITS DE CONVERSIÓN ELECTRÓNICO	172
KITS DE ENCENDIDO	170
PLATINOS	170
ROTORES	169
TAPA	168
TRIGGERS	169
MÓDULOS IGNICIÓN	162

SISTEMA DE REFRIGERACIÓN 177

BOMBA DE AGUA	185
BOMBAS DE BRONCE	186
JUNTAS	187
CORREAS	194
GUÍA CORREAS MOTOR	198
GUÍA CORREAS SERPENTÍN	197
GUÍA DIESEL	195
GUÍA GAS	195
ENFRIADOR DE ACEITE	184
KITS BOTELLAS DE ACEITE	185
KITS ENFRIADOR	184
GUÍA DE IMPULSORES	188
INTERCAMBIADOR DE CALOR	183
KITS	183
KIT DE REPARACIÓN	189
1 R MR ALPHA ONE	189
ALPHA ONE GEN II	190
BRAVO I, II & III	191
DESPIECE	192
POLEA BOMBA	193
TENSOR CORREA V6 & V8	194
MANGUITOS MOTOR	198
BOMBA AGUA	199
BOMBA AGUA --> ENFRIADOR DE ACEITE	199
CUERPO TERMOSTATO -->	200
COLECTOR ESCAPE	200
CULATA --> COLECTOR ESCAPE	198
ENFRIADOR --> CUERPO TERMOSTATO	199
ENFRIADOR DE ACEITE	199
GUÍA MANGUITOS	202
GUÍA MANGUITOS DE COLA	201

GUÍA MANGUITOS EJE --> GASOLINA	203
TOMA AGUA	198
TRANSOM --> ENFRIADOR	199
TERMOSTATO	177
CASQUILLO	178
CONECTOR RÁPIDO	179
CUBIERTA	180
CUERPOS	177
EJE VÁLVULA	179
JUNTAS	180
KIT CUERPO DE TERMOSTATO	177
KITS TERMOSTATOS	181
MÓDULO DISTRIBUCIÓN	179
TERMOSTATOS DIESEL	181
VÁLVULA T	179

PARTES DEL MOTOR 204

JUNTAS DISTRIBUCIÓN	215
JUNTAS TAPA	215
JUNTAS PARA BASES GM Y FORD	204
RETENES	215
GUÍA RETENS ACEITE	216
GUÍA RETENES CIGÜEÑAL	216
GUÍA TÓRICAS	215
JUNTAS MOTOR 4CYL LINEA	217
RETENES CIGÜEÑAL	216
RETENES VÁLVULAS	216
VÁLVULA ADMISIÓN	216

SISTEMA ESCAPE Y ADMISIÓN 218

120 HP GM 153	218
CODO ESCAPE	218
COLECTOR ESCAPE	218
JUNTA CODO ESCAPE	218
JUNTA COLECTOR	218
JUNTA TAPA COLECTOR	218
TAPA COLECTOR	218
DESPIECES COLECTORES Y CODOS	219
140HP GM181	219
2.5L GM 153 4 cyl, 3.0L 4 cyl (1983-89)	220
3.0L/LX GM 181	222
3.0L MPI	223
165, 170, 180, 190, 470, 485, 488	224
3.7L/LX MCM 224 CID	225
GM 160, 165, 200CID, 250, 292CID	225
175, 185, 205, 262 MAG,	226
4.3L/LX/LH/LXH/EFI/MPI, GM 262 CID V6	226
4.3L CARB MPI ALPHA/BRAV	228
262 MAG (TBI), 4.3L/LH/LX/EFI (GEN+), GM	230
262 V6 (1996-01)	231
V6	231
305, 350, 377, 383, 385, (6.2L)	232
MAG MPI HORIZON ALPHA/BRAVO	232
V8 SMALL BLOCK	234
198MIE, 228/MIE & 898, GM305CID, V8	235
250, 255MIE & 260	235
200, 228, 230, 230 MIE, 5.0L/LX, 898,	236
5.0L MPI, GM305 CID, 260/MIE, 320 EFI,	236
350 MAG, GM350 CID, 5.7L/LX, 6.2L MPI	236
V8 (1983 + 2003)	238
330, 340MIE, 370TRS, 454EFI, 454MAG,	238
7.4MIE/LX, GM454 CID V8	238
502 EFI/MAG, 8.2L, GM502 CID V8	240
325-325MIE, GM427 CID V8 330/MIE	240
370TRS - 400TRS - 440TRS - GM454 CID	240
390 - 390MIE - 460TRS, GM472 CID V8	240
225/MIE - 250/MIE - GM327CID - 228/	240
MIE GM305CID - 250 - 270 - 270MIE -	240
280TRS - GM350 CID V8	240
215, 225/MIE, 888 Ford 302 V8 233,	241
233MIE, 255/MIE, Ford 351 V8	241
CODOS	245
CODO ESCAPE INOX	247
EXTENSORES ESCAPE	249
KIT RISER 3"	248
KIT RISER 6"	249
TAPONES	249
COLECTORES	242
COLECTOR ADMISIÓN	254
TAPAS Y JUNTAS	250
FUELLES ESCAPE	253
JUNTAS COLECTOR-CODO	251
JUNTAS COLECTOR-CULATA	252
JUNTAS TAPA INTERCAMBIADOR	251
JUNTAS TAPAS LATERALES	250
PALOMILLA ESCAPE	253
TAPA COLECTOR	250

MERCUISER CUMMINS

UNIDADES DE TRANSMISIÓN	255	DESPIECE COLAS	258	POWER TRIM	305
ALPHA ONE GEN II	257	R MR ALPHA ONE	258	120-140-165-228-250-260-470-485-888-898	305
BRAVO	255	MC1 R	260	R/MR/ALPHA ONE	306
MC1 R MR ALPHA ONE	256	MR ALPHA ONE	264	ALPHA ONE GEN II	307
R MR ALPHA ONE	256	ALHPA ONE GEN II	268	BRAVO	308
ACOPLAMIENTO MOTOR	305	BRAVO	276	LATIGUILLOS POWER TRIM	309
ÁNODOS	284	BRAVO I	278	SILENBLOCK	304
ÁNODO CANADA METAL	288	BRAVO II	280	SOPORTE MOTOR	303
ÁNODO RECMAR	284	BRAVO III	282	TRANSOM	290
ÁNODO TECNOSEAL	286	HERRAMIENTAS	310	ALPHA ONE GEN I & II	290
CAMBIO	300	ADAPTADOR EMBASES ACEITE	314	BRAVO	296
ACOPLE	302	CENTRADOR DE MOTOR	312	CAMPANA BRAVO	296
ACTUADOR CAMBIO ELECTRÓNICO	302	EXTRACTOR	313	CAMPANA, CABLE CAMBIO Y BOMBA DIRECCIÓN	292
CABLE	300	EXTRACTOR DE COJIENTES Y HÉLICES	310	CAMPANA MC, MR1, ALPHA ONE, GEN II	294
CABLE, KIT	300	EXPANSOR DE FUELLES	312	SOPORTE ALPHA ONE GEN II	293
CABLES DIRECCIÓN PRETEC	301	EXTRACTOR DE PIÑONES	310	SOPORTE TRANSOM BRAVO I, II, & III	298
EJE CABLE CAMBIO	302	EXTRACTOR POLEA BOMBA DE DIRECCIÓN	311	TRANSOM COMPLETO	291
GUÍA CABLE	303	EXTRACTOR TAPONES TRIM	312		
KITS CAMBIO	302	HERRAMIENTAS PARA COLAS	311		
KIT RETÉN	303	LLAVE ESTRIADO EJE	312	SISTEMA DE PROPULSIÓN	315
TORNILLO Y PASADOR	302	LLAVE GALGADO PIÑONES	312	HÉLICES AL E INOX DE 3 Y 4 PALAS	315
COMPONENTES TRANSOM	299	LLAVE PARA ELEMENTOS DEL CAMBIO	313	GUÍA HÉLICES CON NÚCLEO INTEGRADO	316
ABRAZADERA FUELLE CAMBIO	300	LLAVE TORNILLO LATERAL TRANSOM	312	HÉLICES PARA BRAVO III	317
CLIP FUELLE	300	LLAVE TUERCA CARDAN	314	HÉLICES PARA ALPHA ONE & BRAVO I	317
FUELLE ESCAPE	300	LLAVE TUERCA DIÁBOLO	311	TABLA DE APLICACIÓN SOLAS	318
KIT FUELLE	299	LLAVE TUERCA EJE VERTICAL	311		
KIT FUELLE CAMBIO	299	PISTOLA DE ACEITE	314		
KIT JUNTAS	299	ÚTIL INSTALACIÓN ANILLO DE FUELLE	312	REF --> RO	319
		VACUOMETRO DOBLE FUNCIÓN	314	RO --> REF	330

EN

DRIVES MAINTENANCE KIT	108	CARBURETOR	132	ELECTRIC SYSTEM	144
GENERIC MATERIALS FOR REVISION	109	CARBURATOR ADAPTER KITS	135	ALTERNATORS & VOLTAGE REGULATORS	153
GUIDE: ENGINE MAINTENANCE	104	CARBURETORS: NEW	133	ALTERNATOR CONVERSION KIT	155
GUIDE: IDENTIFICATION MODEL	102	CARBURATORS: REBUILT	132	VOLTAGE REGULATOR FOR ALTERNATOR	155
GUIDE: MAINTENANCE TRASMISSIONS	108	CHOKE	142	SENSORS	144
		FLAME ARRESTORS	142	AIR TEMPERATURE	148
		FLOAT	136	AIR VALVE	145
		FUEL TUBE FROM PUMP --> CARBURATOR	135	CAMSHAFT	146
FUEL & FILTRATION SYSTEM	110	GASKET	137	COMPLETE TEMPERATURE & OI PRESSURE WARNING KIT	147
GAS ENGINE		GASKET KITS	139	COOLANT TEMPERATURE	148
AIR FILTER	113	GUIDE: GASKET KITS	140	CRANKSHAFT	146
FUEL FILTERS AND ELEMENTS	110	INLET NEEDLE KIT	136	GUIDE	149
BRACKET	110	SCREW	136	IAC	145
BRASS RACCORS	112	FILTER ACCESSORIES	123	KNOCK	145
CARBURETOR FUEL FILTER	113	FUEL PUMP	124	MAT/MAP	144
COMPLETE FUEL FILTER	111	COMPLETE FUEL MODULE	128	OIL PRESSURE	147
IN-LINE FUEL FILTER	112	ELECTRIC FUEL PUMP & COOLER	129	OXYGEN	145
VST FILTER	113	FUEL PRESSURE REGULATOR	129	PICK UP	145
WATER SEPARATING FUEL FILTER	110	GASKET	125	TPS	144
OIL FILTER	114	HIGH PRESSURE FUEL PUMP	126	TRIM	146
FOR AXIUS POWER STEERING	114	LOW PRESSURE FUEL PUMP	127	WATER	148
GUIDE	115	MECHANICAL	124	WATER TEMPERATURE	148
		MECHANICAL PUMP GUIDE	125	SOLENOID, RELAY & FUSES	157
DIESEL		VST GASKETS	129	ALARM	160
AIR FILTER	120	INJEKTOR	130	ATM, ATC, MAXI FUSES	159
FUEL FILTERS AND ELEMENTS	116	FUEL INJEKTOR SEAL KIT	131	BATTERY SWITCH FUSES	159
BOWLS FILTER	117	TURBO	143	CIRCUIT BREAKER	158
COMPLETE DIESEL FILTER	118	EXHAUST CLAMP	143	DELCO REMY SOLENOID	157
FILTER SYPE SEPAR2000	120	GASKET KIT	143	IGNITION KILL SWITCH	160
OIL FILTER	121	SEAL	143	MERCATHODE	159
GUIDE	122	RACOR	122	POWER TRIM SWITCH ASSY	160
TRANSMISSION HURT FILTER	121				



RELAY	158
RELAY FOR ALARM & OTHERS	158
RELAY FOR IGNITION & FUEL PUMP	158
RELAY FOR THROTTLE AND SHIFT	158
SOLENOID	157
SOLENOID EXTENSOR FOR TERMINALS	157
STARTER SOLENOID	157
TRIM FUSE	158
TRIM SOLENOID	157
STARTERS	151
TRIM	155
3 TO 2 WIRE WIRED CONVERTER	156
BRACKET	156
RESERVOIR	156
TRIM ASSY	155

IGNITION SYSTEM 161

DISTRIBUTOR	168
CAP	168
CONDENSERS	170
DISTRIBUTOR	175
ELECTRONIC CONVERSION KITS	172
ELECTRONIC CONVERSION KITS GUIDE	172
ELECTRONIC DISTRIBUTOR	176
IGNITION APPLICATION GUIDE	171
PARTS	173
• DELCO VOYAGER	173
• MPI V6 & V8	175
• THUNDERBOLT IV & V	174
POINTS	170
ROTORS	169
TRIGGERS	169
TUEN UP KITS	170
IGNITION COIL	161
ELECTRONIC IGNITION	161
IGNITION MODULES	162
SPARK PLUG	163
HD SPARK PLUG WIRES SET	167

COOLING SYSTEM 177

BELTS	194
SERPENTINE BELTS GUIDE	197
V-BELTS GUIDE	198
V-BELT GUIDE DIESEL	195
V-BELT GUIDE GAS	195
HEAT EXCHANGER	183
KITS	183
HOSES	198
CYLINDER HEAD --> EXHAUST MANIFOLD	198
HOSES FUEL GUIDE	202
HOSES FUEL GUIDE (SHAFT --> FUEL)	203
HOSES FUEL GUIDE (STERN DRIVES)	201
OIL COOLER	199
OIL COOLER --> THERMOSTAT HOUSING	199
SEAWATER PUMP --> OIL COOLER	199
THERMOSTAT HOUSING --> EXHAUST MANIFOLD	200
TRANSOM --> OIL COOLER	199
WATER PUMP	199
WATER SYSTEM	198
IMPELLER GUIDE	188
OIL COOLER	184
KITS	184
RESERVOIR ASSY KIT	185
THERMOSTAT	177
CHECK BALL KIT	179
FITTING	179
GASKETS	180
SLEEVE	178
TEE VALVE	179
THERMOSTAT COVER	180
THERMOSTAT DIESEL	181
THERMOSTAT HOUSING	177
THERMOSTAT HOUSING KIT	177
THERMOSTAT KITS	181
WATER DISTRIBUTION MODULE	179
WATER PUMPS	185
BRASS WATER PUMP	186
GASKET	187
WATER PUMP SERVICE KIT	189
1 R MR ALPHA ONE	189
ALPHA ONE GEN II	190
BRAVO I, II & III	191
BELT TENSIONER V6 & V8	194
PARTS	192
WATER PUMPS PULLEY	193

ENGINE PARTS 204

MARINE GASKETS TO GM & FORD ENGINES	204
SEALS	215
CRANCKSHAFT SEAL	216
CRANCKSHAFT SEAL GUIDE	216
ENGINE GASKETS	217
INTAKE VALVE	216
O-RING GUIDE	217
OIL SEAL GUIDE	216
VALVE STEAM SEAL	216
TIMING GASKETS	215
TIMING CHAIN COVER GASKETS	215

EXHAUST & INTAKE SYSTEM 218

120 HP GM 153	218
ELBOW MANIFOLD	218
ELBOW MANIFOLD GASKET	218
END CAP	218
END CAP GASKET	218
EXHAUST MANIFOLD	218
MANIFOLD GASKET	218
CAPS & GASKETS	250
END CAP MANIFOLD	250
EXHAUST BELLOW	253
HEAD EXCHANGER END CAP	251
MANIFOLD-ELBOW GASKET	251
MANIFOLD-HEAD GASKET	252
SIDE GASKET CAP	250
WATERS HUTTER	253
ELBOWS	245
CAPS	249
EXHAUST EXTENSIONS	249
KIT RISER 3"	248
KIT RISER 6"	249
SS EXHAUST ELBOW	249
INTAKE MANIFOLD	254
MANIFOLDS	242
MANIFOLDS & ELBOWS PARTS	219
140HP GM181	219
2.5L GM 153 4 cyl, 3.0L 4 cyl (1983-89)	220
3.0L/LX GM 181	222
3.0L MPI	223
165, 170, 180, 190, 470, 485, 488	224
3.7L/LX MCM 224 CID	224
GM 160, 165, 200CID, 250, 292CID	225
175, 185, 205, 262 MAG,	226
4.3L/LX/LH/LXH/EFI/MPI, GM 262 CID V6	228
4.3L CARB MPI ALPHA/BRAV	228
262 MAG (TBI), 4.3L/LH/LX/EFI (GEN+), GM	230
262 V6 (1996-01)	231
V6	231
305, 350, 377, 383, 385, (6.2L)	232
MAG MPI HORIZON ALPHA/BRAVO	234
V8 SMALL BLOCK	234
198MIE, 228/MIE & 898, GM305CID, V8	235
250, 255MIE & 260	236
200, 228, 230, 230 MIE, 5.0L/LX, 898,	236
5.0L MPI, GM305 CID, 260/MIE, 320 EFI,	236
350 MAG, GM350 CID, 5.7L/LX, 6.2L MPI	238
V8 (1983 + 2003)	238
330, 340MIE, 370TRS, 454EFI, 454MAG,	240
7.4MIE/LX, GM454 CID V8	240
502 EFI/MAG, 8.2L, GM502 CID V8	240
325-325MIE, GM427 CID V8 330/MIE	240
370TRS - 400TRS - 440TRS - GM454 CID	240
390 - 390MIE - 460TRS, GM472 CID V8	240
225/MIE - 250/MIE - GM327CID - 228/	241
MIE GM305CID - 250 - 270 - 270MIE -	241
280TRS - GM350 CID V8	241
215, 225/MIE, 888 Ford 302 V8 233,	241
233MIE, 255/MIE, Ford 351 V8	241

TRANSMISSION UNIT 255

ALPHA ONE GEN II	257
BRAVO	255
MC1 R MR ALPHA ONE	256
R MR ALPHA ONE	256
ANODES	284
CANADA METAL	288
RECMAR	284
TECNOSEAL	286
ENGINE MOUNT SCREW	305
ENGINE COUPLER ASSEMBLIES	305
GEAR CASE PARTS	258
R MR ALPHA ONE	258
MC1 R	260
MR ALPHA ONE	264
ALPHA ONE GEN II	268

BRAVO	276
BRAVO I	278
BRAVO II	280
BRAVO III	282
POWER TRIM	305
120-140-165-228-250-260-470-485-	305
888-898	305
R/MR/ALPHA ONE	306
ALPHA ONE GEN II	307
BRAVO	308
POWER TRIM HOSES	309
TRIM PLUGS EXTRACTOR	310
SHIFT	300
CABLE	300
CABLE GUIDE	303
CABLE SLIDE	302
DIGITAL SHIFT ACTUATOR	302
SCREW & PIN	302
SEAL KIT	303
SHIFT CABLE ASSY KIT	300
SHIFT LEVER KIT	302
STEERING CABLE, PRETECH	301
UPPER SHIFT SHAFT	302
SILENBLOCK	304
TOOLS	310
ADAPTOR FOR RECLUBE CONTAINERS	314
BEARING CARRIER RETAINER WRENCH	311
BEARING PULLER	310
BEARING RETAINER WRENCH	314
BELLOW RINGS INTALLATION TOOL	312
BELLOWS EXPANDER TOOLS	312
BOTTLE GREASE PUMP	314
ENGINE ALIGNMENT TOOL	312
GEAR CASE TOOL KIT	311
HINGE PIN TOOL	312
PINION GEAR SHIMMING TOOL	312
PRESSURE / VACUUM TESTER	314
PROP & BEARING PULLER	310
PROP SHAFT ADAPTOR	312
PROP WRENCH KIT	311
PULLEY REMOVER	311
PULLEY ROD	313
TOOLS FOR ELEMENTS TO DRIVESHAFT	313
TRANSOM	290
BELL HOUSING BRAVO	297
BELL HOUSING MC, MR1, ALPHA ONE,	294
GEN II	294
GIMBAL HOUSING BRAVO	296
GIMBAL HOUSING ET POWER STEERING	290
CYLINDER KIT ALPHA ONE GEN I & II	290
GIMBAL HOUSING RING ASSY. BRAVO I,	298
II, & III	298
GIMBALL HOUSING RING ASSY ALPHA	293
ONE GEN II	293
TRANSOM ASSY	290
TRANSOM PLATE, SHIFT CABLE & PUMP	292
ASSY. POWER STEERING	292
TRANSOM COMPONENTS	299
BELLOW KIT	300
EXHAUST BELLOW	300
GASKET SET	299
SHIFT CABLE BELLOW CLAMP	300
SHIFT CABLE BELLOW KIT	299
U-JOINT BELLOWS KIT	299

PROPULSION SYSTEM 315

3 & 4 BLADE AL & SS PROPELLERS	315
PROPELLERS APPLICATION WITH RUBBER	316
HUB	317
PROPELLER FOR BRAVO III	317
PROPELLER FOR ALPHA ONE & BRAVO I	317
PROPELLERS SOLAS APPLICATION GUIDE	318

REF --> OEM	319
OEM --> REF	330



GUÍA DI IDENTIFICAZIONE MODELLO MOTORE	102
GUÍA MANUTENZIONE MOTORI	104
GUIDA MANUTENZIONE TRASMISSIONI	108
KIT MANUTENZIONE PIEDE	108
MATERIALE GENERICO PER LA REVISIONE	109

SISTEMA DI ALIMENTAZIONE E FILTRAZIONE 110

BENZINA	
FILTRI ARIA	113
FILTRI BENZINA E RACCORDI	110
FILTRO CARBURATORE	113
FILTRO DECANTATORE	111
FILTRO PER MONTARE IN LINEA	112
FILTRO SEPARATORE ACQUA-BENZINA	110
FILTRO VST	113
RACCORDI IN OTTONE	112
SUPPORTO	110
FILTRO OLIO	114
PER MOTORI CON STERZZO IDRULICO AXIUS	114
GUIDA	115

DIESEL	
FILTRO ARIA	120
FILTRI BENZINA E ELEMENTI	116
FILTRO CON COPPA	117
FILTRO DECANTATORE	118
FILTRO DI TIPO SEPAR2000	120
FILTRO TRASMISSIONE HURT	121
FILTRO OLIO	121
GUIDA	122

ACCESSORI PER FILTRI	123
CARBURATORE	132
CARBURATORE NUOVI	133
CARBURATORE RIGENERATI	132
CHOKE	142
GALLEGGIANTI	136
GUARNIZIONE	137
GUIDA	139
GUIDA KIT	140
KIT ADATTATORE CARBURATORI	135
KIT SPILLO	136
PARAFIAMMA	142
TUBO DA COMBUSTIBILE, POMPA --> CARBURATORE	135
VITI	136
INIETTORE	130
KIT PARAOLIO	131
POMPA COMBUSTIBILE	124
GUARNIZIONE VST	129
GUARNIZIONI	125
GUIDA POMPI MECCANICHE	125
MODULO CARBURANTE COMPLETO	128
POMPA ALTA PRESSIONE	126
POMPA BASSA PRESSIONE	127
POMPA BENZINA E KIT SCAMBIATORE	129
POMPA MECCANICA	124
REGOLATORI PRESSIONE CARBURANTE	129
RACCORDI	122
TURBINE	143
KIT GUARNIZIONE	143
FASCETTA SCARICO	143
PARAOLIO	143

SISTEMA ELETTRICO 144

ALTERNATORI E REGOLATORI	153
KIT SOSTITUZIONE ALTERNATORE	155
REGOLATORE ALTERNATORE	155
MOTORINI AVVIAMENTO	151
SENSORE	144
ACQUA	148
ALBERO A CAMES	146
DI CADUTA	145
GUIDA	149
IAC	145
MAT/MAP	144
OXSSIGENO	145
PICK UP	145
POSIZIONE ALBERO MOTORE	146
POSIZIONE ASSE A CAMME	146
PRESSIONE OLIO	147
TEMPERATURA ACQUA	148
TEMPERATURA ARIA	148

TEMPERATURA E PRESSIONE DELL'OLIO	147
TEMPERATURA SCAMBIATORE	148
TPS	144
TRIM	146
VALVOLA ARIA	145
SOLENOIDI, RELÉ E FUSIBILE	157
ALLARME	160
FUSIBILE ATM, ATC, MAXI	159
FUSIBILE MOTORE	158
FUSIBILE MOTORINI TRIM	158
FUSIBILE TERMINALE BATERIA	159
INTERRUTTORE TRIM	160
INTERRUTTORI DI STOP	160
MERCATHODE	159
PROLUNGA TERMINALE PER SOLENOIDE	157
RELÉ	158
RELÉ DI ACCELERATORE E ASSE	158
RELÉ DI AVVIAMENTO E POMPA BENZINA	158
RELÉ PER ALARMA E ALTRI	158
SOLENOIDI	157
SOLENOIDI AVVIAMENTO	157
SOLENOIDI DELCO REMY	157
SOLENOIDI TRIM	157
TRIM	155
CONVERTITORE CAVI DA 3 A 2 FILI	156
SUPPORTO	156
TRIM COMPLETO	155
VASCHETTA	156

SISTEMA ACCENSIONE 161

BOBINA	161
ACCENSIONE ELETTRONICA	161
CANDELE	163
KIT CAVI CANDELE ALTE PRESTAZIONI	167
MODULI AVVIAMENTO	162
SPINTEROGENE	168
CALOTTE	168
CONDENSATORI	170
ESPLOSO	173
• DELCO VOYAGER	173
• MPI V6 & V8	175
• THUNDERBOLT IV & V	174
GUIDA KIT CONVERSIONE ELETTRICO	172
GUIDA KITS DE ACCENSIONE	171
KIT D'ACCENSIONE	170
KIT DI CONVERSIONE ELETTRICO	172
PUNTINE	170
ROTORI	169
SPINTEROGENO	175
SPINTEROGENO ELETTRICO	176
TRIGGERS	169

SISTEMA DI RAFFREDDAMENTO 177

CINGHIA	194
GUIDA BENZINA	195
GUIDA CINGHIA MOTORE	198
GUIDA CINGHIA SERPENTINA	197
GUIDA DIESEL	195
GUIDA GIRANTE	188
KIT RICAMBI	189
1 R MR ALPHA ONE	189
ALPHA ONE GEN II	190
BRAVO I, II & III	191
ESPLOSO	192
PULIGGIA POMPE	193
TENDICINGHIA V6 & V8	194
MANICOTTO MOTOR	198
CORPO TERMOSTATO --> COLLETTOR SCARICO	200
GUIDA MANICOTTO	202
GUIDA MANICOTTO ASSE-->BENZINA	203
GUIDA MANICOTTO PIEDE	201
POMPA ACQUA	199
POMPA ACQUA --> SCAMBIATORE OLIO	199
PRESA ACQUA	198
SCAMBIATORE OLIO	199
SCAMBIATORE OLIO --> CORPO TERMO-STATO	199
TESTATA --> COLLETORE DI SCARICO	198
TRANSOM --> SCAMBIATORE OLIO	199
POMPE ACQUA	185
GUARNIZIONE	187
POMPE IN BRONZO	186
RAFFREDDAMENTO DELL'OLIO	184

KIT BOTTIGLIA OLIO	185
KIT RAFFREDDAMENTO	184
SCAMBIATORE DI CALORE	183
KIT	183
TERMOSTATO	177
ASSE VALVOLA	179
BOCCOLA	178
CONNECTTORE	179
COPERCHIO	180
CORPO	177
GUARNIZIONE	180
KIT CORPO TERMOSTATO	177
KIT TERMOSTATO	181
MODULO DISTRIBUZIONE	179
TERMOSTATO DIESEL	181
VALVOLA T	179

PARTI MOTORE 204

GUARNIZIONE MOTORI GM E FORD	204
GUARNIZIONE DISTRIBUZIONE	215
GUARNIZIONE CARTER	215
TENUTE	215
GUARNIZIONE MOTORE 4CYL LINEA	217
GUIDA O-RING	215
GUIDA PARAOLIO	216
GUIDA PARAOLIO ALBERO MOTORE	216
PARAOLIO VALVOLE	216
VALVOLA ASPIRAZIONE	216

SISTEMA DI ESCARICO E ASPIRAZIONE 218

120 HP GM 153	218
COLLETORE SCARICO	218
COPERCHIO COLLETORE	218
GOMITO DI SCARICO	218
GUARNIZIONE COLLETORE	218
GUARNIZIONE DI SCARICO	218
GUARNIZIONE COPERCHIO COLLETORE	218
COLLETTORI	242
COLLETORE ASPIRAZIONE	254
COPERCHI E GUARNIZIONE	250
COPERCHIO COLLETORE	250
COPERCHIO POSTERIORE SCAMBIATORE	251
CUFFIA DI SCARICO	253
FARFALLA DI SCARICO	253
GUARNIZIONE COLLETORE-GOMITO	251
GUARNIZIONE COLLETORE-TESTATA	251
GUARNIZIONE COPERCHIO LATERALE	250
GOMITI	245
ESTENSIONI DI SCARICO	249
GOMITI SCARICO INOX	247
KIT RISER 3"	248
KIT RISER 6"	249
TAPPI	249
PARTI COLLETTORI E GOMITI	219
140HP GM181	219
2.5L GM 153 4 cyl, 3.0L 4 cyl (1983-89)	220
3.0L/LX GM 181	222
3.0L MPI	223
165, 170, 180, 190, 470, 485, 488	
3.7L/LX MCM 224 CID	224
GM 160, 165, 200CID, 250, 292CID	225
175, 185, 205, 262 MAG,	
4.3L/LX/LH/LXH/EFI/MPI, GM 262 CID V6	226
4.3L CARB MPI ALPHA/BRAV	228
262 MAG (TBI), 4.3L/LH/LX/EFI (GEN+), GM 262 V6 (1996-01)	230
V6	231
305, 350, 377, 383, 385, (6.2L)	
MAG MPI HORIZON ALPHA/BRAVO	232
V8 SMALL BLOCK	234
198MIE, 228/MIE & 898, GM305CID, V8 250, 255MIE & 260	235
200, 228, 230, 230 MIE, 5.0L/LX, 898, 5.0L MPI, GM305 CID, 260/MIE, 320 EFI, 350 MAG, GM350 CID, 5.7L/LX, 6.2L MPI V8 (1983 + 2003)	
330, 340MIE, 370TRS, 454EFI, 454MAG, 7.4MIE/LX, GM454 CID V8	238
502 EFI/MAG, 8.2L, GM502 CID V8	
325-325MIE, GM427 CID V8 330/MIE 370TRS - 400TRS - 440TRS - GM454 CID 390 - 390MIE - 460TRS, GM472 CID V8 225/MIE - 250/MIE - GM327CID - 228/MIE GM305CID - 250 - 270 - 270MIE - 280TRS - GM350 CID V8	240
215, 225/MIE, 888 Ford 302 V8 233, 233MIE, 255/MIE, Ford 351 V8	241

UNITÀ DI TRASMISSIONE 255

ALPHA ONE GEN II	257
BRAVO	255
R MR ALPHA ONE	256
MC1 R MR ALPHA ONE	256
ACCOPIAMENTO MOTORE	305
ANODI	284
ANODO CANADA METAL	288
ANODO RECMAR	284
ANODO TECNOSEAL	286
ATTREZZI	
ADATTATORE PER CONTENITORI RECLUBE	
ATTREZZO PER CUFFIE	
CENTRATORE MOTORE	
CHIAVE ASSE STRITO	
CHIAVE CARDANO	
CHIAVE PER CUSCINETTO	
CHIAVE PER GLI ELEMENTI DEL CAMBIO	
CHIAVE PER PEIGNONI	
CHIAVE VITE LATERALE TRANSOM	
ESTRATTORE	
ESTRATTORE CUSCINETTI E ELICHE	
ESTRATTORE PIGNONE	
KIT ATTREZZI PIEDI	
KIT CHIAVE ELICA	
PISTOLA OLIO	
STRUMENTO PER L'INSTAL. DELL'ANELLO DEL SOFFIETTO	
VACUOMETRO DOPPIA FUNZIONE	
CAMBIO	300
ACCOPIO	302
ALBERINO CAMBIO	302
ATTUATORE CAMBIO	302
CAVI DI TIMONERIA PRETEC	301
CAVO	300
GUIDA CAVO	303
KIT CAMBIO	302
KIT CAVO	300
KIT TENUTE	303
VIS E SPINOTTO	302
COMPONENTI TRANSOM	299
CLIP FUELLE	300
CUFFIE DI SCARICO	300
FASCETTA CUFFIE CAMBIO	300
KIT CUFFIE	299
KIT CUFFIE CAMBIO	299
KIT GUARNIZIONI	299
PARTI PIEDI	258
R MR ALPHA ONE	258
MC1 R	260
MR ALPHA ONE	264
ALPHA ONE GEN II	268
BRAVO	276
BRAVO I	278
BRAVO II	280
BRAVO III	282
POWER TRIM	305
120-140-165-228-250-260-470-485-888-898	305
R/MR/ALPHA ONE	306
ALPHA ONE GEN II	307
BRAVO	308
ESTRATTORE PER TAPPI TRIM	310
TUBI POWER TRIM	309
SILENBLOCK	304
SUPPORTI MOTORE	303
TRANSOM	290
ALPHA ONE GEN I & II	290
BRAVO	296
CAMPANA BRAVO	296
CAMPANA MC, MR1, ALPHA ONE, GEN II	294
CAMPANA, CAVO CAMBIO E POMPA STERZO	292
SUPPORTO ALPHA ONE GEN II	293
SUPPORTO TRANSOM BRAVO I, II, & III	298
TRANSOM COMPLETO	291

SISTEMA DI PROPULSIONE 315

ELICHE AL E INOX DE 3 E 4 PALE	315
ELICHE PER ALPHA ONE & BRAVO I	317
ELICHE PER BRAVO III	317
GUIDA APPLICAZIONE ELICHE SOLAS	318
GUIDA ELICHE CON MOZZO	316

REF --> RO	319
RO --> REF	330

GUIDE D'IDENTIFICATION MOTEURS	102
GUIDE MAINTENANCE MOTEURS	104
GUIDE MAINTENANCE TRANSMISSIONS	108
KIT D'ENTRETIEN DES EMBASSES	108
MATÉRIAUX GÉNÉRIQUES POUR L'EXAMEN	109

SYSTÈME D'ALIMENTATION ET FILTRATION 110

ESSENCE	
FILTRE AIRE	113
FILTRE À HUILE	114
PARÀ DIRECCIÓN HIDRÁULICA AXIUS	114
GUÍA	115
FILTRE ET CARTOUCHES DE RECHANGE	110
BRACKET	110
FILTRE À ESSENCE CARBURATEUR	113
FILTRE À ESSENCE EN LIGNE	112
FILTRE DÉCANTATEUR	111
FILTRE SÉPARATEUR D'EAU	110
FILTRE VST	113
RACCORDS À LAITON	112

DIESEL	
FILTRE AIRE	120
FILTRE À HUILE	121
GUIDE	122
FILTRE ET CARTOUCHES DE RECHANGE	116
FILTRE AVEC COUPE	117
FILTRE DÉCANTATEUR	118
FILTRE TYPE SEPAR2000	120
FILTRE TRANSMISSION HURT	121

ACCESSOIRE POUR FILTRES	123
CARBURATEUR	132
ARRÊTEURS DE FLAMMES	142
CARBURATEUR NOUVEAU	133
CARBURATEUR REMANUFACTURÉS	132
CHOKE	142
FLOTEURS	136
GUIDE	139
GUIDE DES KITS	140
JOINTS	137
KIT ADAPTEURS	135
KIT POINTEAU	136
TUYAU, POMPE --> CARBURATEUR	135
VIS	136
INJECTEURS	130
KIT JOINTS	131
POMPE À CARBURANT	124
GUIDE DE POMPES MECANQUES	125
JOINTS	125
JOINTS VST	129
MODULE DE CARBURANT COMPLET	128
POMPE BASE PRESSION	127
POMPE ET REFRIGÉRISEUR	129
POMPE HAUTE PRESSION	126
POMPE MECANIQUE	124
REGULATEUR PRESSION DE CARBURANT	129
RACCORDS	122
TURBO	143
KIT JOINTS	143
COLLIER ÉCHAPPEMENT	143
JOINT SPI DE TURBO	143

SYSTÈME ÉLECTRIQUE 144

ALTERNATEURS ET REGULATEURS	153
KIT ALTERNATEUR	155
REGULATEUR ALTERNATEUR	155
CAPTEURS	144
CAPTEUR DE CLIQUETIS	145
GUIDE DES SONDAS	149
IAC	145
MAT/MAP	144
OXYGENE	145
PICK UP	145
PRESSION D'HUILE	147
SONDE DE L'EAU	148
SONDE POSITION ARBRE À CANNES	146
SONDE POSITION VILEBREQUIN	146
SOUPAPE D'AIRE	145
TEMPERATURE DE REFRIGÉRISEUR	148
TEMPERATURE DE L'AIRE	148
TEMPERATURE DE L'EAU	148
TEMP. ET PRESSION D'HUILE AVEC ALARME	147
TPS	144
TRIM	146

DÉMARREUR	151
SOLÉNOÏDE, RELAIS ET FUSIBLES	157
BUZZER D'ALARME	160
COMMUTATEUR DE TRIM	160
EXTENSION POUR SOLÉNOÏDE	157
FUSIBLE ATM, ATC, MAXI	159
FUSIBLE MOTEUR	158
FUSIBLE TERMINAL DE BATERIE	159
FUSIBLE TRIM	158
INTERRUPTEUR DE STOP	160
MERCATHODE	159
RELAIS	158
RELAIS DE DÉMARREUR ET POMPE D'ESSENCE	158
RELAIS POUR ALARME ET D'AUTRES	158
RELAIS POUR L'ACCELERATION ET L'ARBRE SOLÉNOÏDE	157
SOLÉNOÏDE DELCO REMY	157
SOLÉNOÏDE DÉMARREUR	157
SOLÉNOÏDE TRIM	157
TRIM	155
FAISCEAU CONVERTISSEUR 3 À 2 FILS	156
RESERVOIR	156
SUPPORT	156
TRIM COMPLET	155

SYSTÈME D'ALLUMAGE 161

ALLUMEUR	168
CONDENSATEUR	170
DISTRIBUTEUR	175
DISTRIBUTEUR ÉLECTRONIQUE	176
DOIGT D'ALLUMEUR	169
GUIDE KITS D'ALLUMAGE	171
GUIDE KITS DE CONVERSION ÉLECTRONIQUE	172
KIT DOIGT D'ALLUMEUR	169
KITS DE CONVERSION ÉLECTRONIQUE	172
KITS S'LLUMAGE	170
PIÈCES	173
• DELCO VOYAGER	173
• MPI V6 & V8	175
• THUNDERBOLT IV & V	174
TÊTE D'ALLUMEUR	168
VIS PLATINÉS	170
BOBINE D'ALLUMAGE	161
ALLUMAGE ÉLECTRONIQUE	161
BOUGIES	163
KIT FAISCEAU DE BOUGIE	167
MODULES D'ALLUMAGE	162

SYSTÈME DE REFROIDISSEMENT 177

COURROIES	194
GUIDE DE COURROIES MOTEUR	198
GUIDE DE COURROIES SERPENTINE	197
GUIDE DIESEL	195
GUIDE GAS	195
ÉCHANGEUR DE CHALEUR	183
KITS	183
GUIDE TURBINES	188
KIT REPARATION DE POMPE À EAU	189
1 R MR ALPHA ONE	189
ALPHA ONE GEN II	190
BRAVO I, II & III	191
PIÈCES	192
POULIE	193
TENDEUR DE COURROIE V6 & V8	194
POMPE D'EAU	185
POMPE À EAU BRONZE	186
JOINTS	187
REFROIDISSEUR D'HUILE	184
KITS REFROIDISSEUR	184
KITS RESERVOIR D'HUILE	185
THERMOSTAT	177
AXE VALVE	179
CALE	178
CORPS	177
COUVERCLE	180
JOINTS	180
KIT CORPS DE THERMOSTAT	177
KITS THERMOSTATS	181
MODULE DE DISTRIBUTION	179
RACCORD VIDANGE	179
THERMOSTATS DIESEL	181
VALVE T	179

TUAYAU MOTEUR	198
CORP THERMOSTAT --> D'ÉCHAPPEMENT	200
CULASSE --> COLLECTEUR D'ÉCHAPP.	198
ENTRÉE D'EAU	198
GUIDE TUYAUX	202
GUIDE TUYAUX ARBRE-ESSENCE	203
GUIDE TUYAUX D'EMBASE	201
POMPE D'EAU	199
POMPE D'EAU --> REFFROIDISSEUR D'HUILE	199
REFROIDISSEUR D'HUILE	199
REFROIDISSEUR --> CORP THERMOSTAT	199
TRANSOM --> REFFROIDISSEUR D'HUILE	199

PIÈCES MOTEUR 204

JOINTS DISTRIBUTION	215
JOINTS COUVERCLE	215
JOINTS D'HUILE	215
GUIDE JOINTS D'HUILE	216
GUIDE JOINTS D'HUILE VILEBREQUIN	216
GUIDE JOINTS SPI	215
JOINT DE SOUPAPE	216
JOINTS D'HUILE VILEBREQUIN	216
JOINTS MOTEUR 4CYL EN LIGNE	217
SOUPAPE ADMISSION	216
JOINTS POUR MOTEUR GM ET FORD	204

SYSTÈME ÉCHAPPEMENT ET ADMISSION 218

120 HP GM 153	218
COLLECTEUR D'ÉCHAPPEMENT	218
COUDE D'ÉCHAPPEMENT	218
COUVERCLE COLLECTEUR	218
JOINT COLLECTEUR	218
JOINT COUDE D'ÉCHAPPEMENT	218
JOINT COUVERCLE COLLECTEUR	218
COLLECTEURS	242
COLLECTEUR ADMISSION	254
COUDES	245
BOUCHONS	249
COUDES D'ÉCHAPPEMENT INOX	247
KIT RISER 3"	248
KIT RISER 6"	249
PROLONGATEURS D'ÉCHAPPEMENT	249
COUVERCLES ET JOINTS	250
CLAPET D'ÉCHAPPEMENT	253
COUVERCLE COLLECTEUR	250
SOUFFLET D'ÉCHAPPEMENT	253
JOINTS COLLECTEUR - COUDE	251
JOINTS COLLECTEUR-CULASSE	252
JOINTS COUVERCLE LATERAL	250
JOINTS DE L'ÉCHANGEUR	251
PIÈCES COLLECTEURS ET COUDES	219
140HP GM181	219
2.5L GM 153 4 cyl, 3.0L 4 cyl (1983-89)	220
3.0L/LX GM 181	222
3.0L MPI	223
165, 170, 180, 190, 470, 485, 488	224
3.7L/LX MCM 224 CID	224
GM 160, 165, 200CID, 250, 292CID	225
175, 185, 205, 262 MAG,	226
4.3L/LX/LH/LXH/EFI/MPI, GM 262 CID V6	226
4.3L CARB MPI ALPHA/BRAV	228
262 MAG (TBI), 4.3L/LH/LX/EFI (GEN+),	230
GM 262 V6 (1996-01)	231
V6	231
305, 350, 377, 383, 385, (6.2L)	232
MAG MPI HORIZON ALPHA/BRAVO	232
V8 SMALL BLOCK	234
198MIE, 228/MIE & 898, GM305CID, V8	235
250, 255MIE & 260	235
200, 228, 230, 230 MIE, 5.0L/LX, 898,	236
5.0L MPI, GM305 CID, 260/MIE, 320 EFI,	236
350 MAG, GM350 CID, 5.7L/LX, 6.2L MPI	236
V8 (1983 + 2003)	236
330, 340MIE, 370TRS, 454EFI, 454MAG,	238
7.4MIE/LX, GM454 CID V8	238
502 EFI/MAG, 8.2L, GM502 CID V8	238
325-325MIE, GM427 CID V8 330/MIE	240
370TRS - 400TRS - 440TRS - GM454 CID	240
390 - 390MIE - 460TRS, GM472 CID V8	240
225/MIE - 250/MIE - GM327CID - 228/	240
MIE GM305CID - 250 - 270 - 270MIE -	240
280TRS - GM350 CID V8	240
215, 225/MIE, 888 Ford 302 V8 233,	241
233MIE, 255/MIE, Ford 351 V8	241

EMBASES ET PIÈCES 255

ALPHA ONE GEN II	257
BRAVO	255
MC1 R MR ALPHA ONE	256
R MR ALPHA ONE	256
ACCOUPEMENT MOTEUR	305
ANODES	284
ANODE CANADA METAL	288
ANODE RECMAR	284
ANODE TECNOSEAL	286
CHANGEMENT	300
ACTIONNEUR DE CHANGEMENT ÉLECTRON.	302
ARBRE CHANGEMENT	302
ATTACHE	302
CÂBLE	300
CÂBLES DE COMMANDE PRETEC	301
GUIDE CÂBLE	303
KIT CÂBLE	300
KIT JOINT D'HUILE	303
KITS CHANGEMENT	302
VIS ET PIN	302
COMPONENTS TRANSOM	299
CLIPS	300
COLLIER SOUFFLET CHANGEMENT	300
KIT JOINTS	299
KIT SOUFFLET	299
KIT SOUFFLET CHANGEMENT	299
SOUFFLET D'ÉCHAPPEMENT	299
OUTILS	310
ADAPTEUR ARBRE DE TRANSMISSION	313
ADAPTEUR CONTENEURS D'HUILE RECLUBE	314
CLÉ POUR ARBRE D'HELICE	312
CLÉ POUR ARBRE VERTICAL	311
CLÉ POUR ÉCROU D'ARBRE	314
CLÉ POUR ÉCROU DE DIABOLO	311
CLÉ POUR PIGNONS	312
EXTRACTEUR DE POULIE	313
EXTRACTEUR DE ROULEMENTS	310
EXTRACTEUR DE ROULEMENTS ET D'HELICE	310
OUTIL D'ALIGNEMENT	312
OUTIL D'INSTALLATION ANNE DE SOUFFLET	312
OUTIL DE MONTAGE SOUFFLETS	312
OUTILS OUR EMBASES	311
PISTOLET POUR HUILE D'EMBASE	314
VACUOMETRE DOUBLE FONCTION	314
PIÈCES D'EMBASES	258
R MR ALPHA ONE	258
MC1 R	260
MR ALPHA ONE	264
ALPHA ONE GEN II	268
BRAVO	276
BRAVO I	278
BRAVO II	280
BRAVO III	282
POWER TRIM	305
120-140-165-228-250-260-470-485-	305
888-898	305
ALPHA ONE GEN II	307
BRAVO	308
R/MR/ALPHA ONE	306
EXTRACTEUR BOUCHONS DE TRIM	310
FLEXIBLE DE POWER TRIM	309
TRANSOM	290
ALPHA ONE GEN I & II	290
BRAVO	296
CASQUE BRAVO	296
CASQUE MC, MR1, ALPHA ONE, GEN II	294
CASQUE, CÂBLE CHANGEMENT ET POMPA	292
DIRECTION	292
SUPPORT ALPHA ONE GEN II	293
SUPPORT TRANSOM BRAVO I, II, & III	298
TRANSOM COMPLET	291
SILENBLOCK	304
SUPPORT MOTEUR	303

SYSTÈME DE PROPULSION 315

HÉLICES AL ET INOX DE 3 ET 4 PALES	315
GUIDE DES HÉLICES ET MOYEUX	316
HÉLICES POUR BRAVO III	317
HÉLICES POUR ALPHA ONE & BRAVO I	317
TABLEAU D'APPLICATION D'HÉLICES SOLAS	318
REF --> RO	319
RO --> REF	330

GUÍA IDENTIFICACIÓN DE MODELOS

MODEL IDENTIFICATION CHART

GUIDA DI IDENTIFICAZIONE MODELLO MOTORE

GUIDE D'IDENTIFICATION MOTEURS

	MOD.	S/N		
SEA RAY	3.0L	B787205-B917529	1988	
	4.3L	B785483-B921276	1988	
	4.3LX	B785981-B922330	1988	
	5.7L	B784799-B917017	1988	
	SRX5.7L, 350 MAG	B785241-B919012	1988	
	SRX7.4L, 454 MAG ALPHA	B785149-B924857	1988	
STERN DRIVES	SRX7.4L-H, 454 MAG BRAVO	B721206-B919343	1988	
	SRX7.4L, ALPHA	B803866-C348032	1988	
INBOARD ENGINES	SRX7.4L-H, BRAVO	B803872-B999972	1988	
	5.7L	B788204-B919356	1988	
RENAULT 4 CYL. (STERN DRIVE)	7.4L	B788179-B913769	1988	
	60	1887079-5049044	1965-68	
GM 4 CYL. (STERN DRIVE)	80	2049045-2851423	1966-69	
	90	2851424-3226957	1970-72	
GM 4 CYL. (STERN DRIVE)	110	1537370-2044033	1963-66	
	120	1666601-3377340	1964-72	
	120	3377341-3770649	1972-73	
	120	3770650-4952700	1974-77	
	120	4952701-5192048	1978	
	120	5192049-6229717	1979-82	
	120	6229718-6853913	1983-84	
	120	6853914-B531853	1985-86	
	120/2.5L	B531854-C853255	1987-89	
	140	2508261-6229717	1968-82	
	140/3.0L	6229718-C856558	1982-89	
	3.0L/LX	C856559+	1990	
	MERCURY MARINE 4 CYL. (STERN DRIVE)	470 (2 BBL)	4208730-5520114	1976-79
		470 (2 BBL)	5520115-6218036	1980-82
470 (2 BBL)		6218037-6916778	1983-84	
170 (2 BBL)		6916779	1985-86	
165/3.7L (2 BBL)		6916779	1987-89	
485 (2 BBL)		5685394-6218036	1980-82	
488 (4 BBL)		6170297-6916778	1983-84	
190 (4 BBL)		6916779	1985-86	
GM INLINE 6 CYL. (STERN DRIVE)	180/3.7LX (4 BBL)	6916779	1987-89	
	140	1538930-1725960	1963	
	150	1666495-2048046	1964-66	
	160	2048022-2770031	1967-69	
	165	2770032-5178958	1970-78	
	165	5178959-5813433	1979-81	
GM V6 (STERN DRIVE)	200	2453769-2712072	1969	
	185 (4 BBL)	6330183-6919655	1983-84	
	185 (2 BBL)	A331455-B527954	1985-87	
	175/4.3L (2 BBL)	B527955-D714106	1987-92	
	4.3L (GEN II) (2 BBL)	D714107-F000877	1992-93	
	4.3L (GEN II) (2 BBL)	F000878-F601126	1993-95	
	4.3L (GEN II) (2 BBL)	F601127-F000878	1996	
	4.3LX (GEN+) (2 BBL)	F803000-K999999	1996-97	
	4.3L (GEN+) (2 BBL)	L010044+	1998	
	4.3L EFI (GEN+) (TBI)	L012009+	1998	
	205 (4 BBL)	A331455-B527954	1985-87	
	205/4.3LX (4 BBL)	B527955-D714369	1987-91	
	4.3LX (GENII) (4 BBL)	D714370-F001219	1992-93	
	4.3LX (GENII) (4 BBL)	F001220-F601126	1993-95	
	4.3LX (GENII) (4 BBL)	F601127-F802999	1996	
	4.3LXH (GEN+) (4 BBL)	F803114+	1996-97	
4.3LH (GEN+) (4 BBL)	L010044+	1998		
FORD V8 (STERN DRIVE)	262 MAG (TBI) (GEN+)	F803800-K999999	1996-97	
	888 (2 BBL)	3108723-4887829	1971-77	
	215 (4 BBL)	2781153-3385720	1970-72	
	225 (4 BBL)	3385721-4166999	1973-74	
	225-S (4 BBL)	3385721-4166999	1973-74	
	233	4173000-4902304	1975-77	
	255	3258728-4175499	1971-74	

	MOD.	S/N	
GM V8 283, 327, 305 & 350 CID	190	1564539-1730903	1963-64
	898 (2 BBL)	4762210-6218461	1977-82
	898 (2 BBL)	6218462-B525981	1983-84
	200/5.0L (2 BBL)	6218462-F600999	1985-95
	5.0L (2 BBL)	L015751+	1998
	5.0L EFI	L012052-L340000	1998-99
	228 (4 BBL)	4765100-5170008	1977-78
	228 (4 BBL)	5170009-6218461	1979-82
	228 (4 BBL)	6218462-B525981	1982-84
	230 (4 BBL)	6218462-B525981	1985-86
	230/5.0LX (4 BBL)	B525982-F600999	1987-95
	225	1539620-2694014	1963-69
	250	2314301-2639854	1968-69
	255	417550-4767999	1975-76
	250	4768000-4908849	1977
	260/5.7L	4908850-6218461	1978-82
	260/5.7L	621462-B525981	1982-86
	260/5.7L	B525982-F600999	1987-95
	5.7L (2 BBL)	F601000+	1996-98
	5.7L EFI	F225560+	1995
	5.7LX (4 BBL)	F601000-K999999	1996-97
	5.7LX EFI	F752400-K999999	1996-97
	5.7LX BRAVO EFI	F800300-K999999	1996-97
	350 MAG ALPHA	A635178-B525981	1986-87
	350 MAG ALPHA	B525982-F600999	1987-95
	350 MAG ALPHA	F601000-K001526	1996
	350 MAG ALPHA	K001527-K999999	1997
	350 MAG ALPHA EFI	F800300-K999999	1996-97
	350 MAG BRAVO MPI	F415189-K999999	1995-97
	350 MAG BRAVO MPI (GEN+)	F602000-K999999	1996-97
	350 MAG MPI (GEN+)	L010019+	1998
	270	2851074-3385720	1969-72
280TRS	4176250-4770199	1975-76	
300 TEMPEST	6668677-B430367	1985-86	
320 EFI	A543604-C622418	1987-89	
GM V8 427, 454, 502, 540 & 572 (STERN DRIVE)	325	2278747-3780449	1969-72
	330	4623115-6083144	1977-81
	330	6083145-B816450	1982-87
	7.4L BRAVO	B771113-D603117	1988-91
	7.4L BRAVO (GEN V)	D603118-F800699	1992-96
	7.4L BRAVO (GEN VI)	F800700-K999999	1996-97
	7.4LX BRAVO (MPI) (GEN V)	F602010-F801999	1996
	7.4LX BRAVO (MPI) (GEN VI)	F802000-K999999	1996-97
	7.4L MPI (GEN VI)	L010003+	1998
	7.4LX BRAVO (TBI) (GEN VI)	F820000-K999999	1996-97
	454 MAG ALPHA	A631894+	1986-88
	454 MAG BRAVO (GEN V)	D805069-F304999	1992-94
	454 MAG BRAVO (GEN V)	F305000-F801699	1995-96
	454 MAG BRAVO (GEN VI)	F801700-K999999	1996-97
	454 EFI (GEN V)	F115700-F802349	1994-96
	454 MAG MPI (GEN VI)	F802350-K999999	1996-97
	454 MAG MPI (GEN VI)	L010029-L085399	1998
	454 MAG MPI (GEN VI)	L085400+	1999
	370 TRS	4179554-6721527	1978-85
	370 TRS	6721528-B714586	1985-87
	400 TRS	4179554-B457644	1980-86
	420	A398941-D937011	1987-89
	425	A398941-D937011	1990-93
	440 TRS	4179554-B485220	1983-86
	450 (GEN V)	F347100-F347277	1995-96
	525 SC	D456000-F348963	1991-92
	525 SC (GEN V)	D456000-F348963	1992-95
	525 SC (GEN V)	F615814-F745215	1996
	525 SC (GEN VI)	F745260+	1996-97
	390	2781129-3042731	1969-70
	460 TRS	4719554-6181046	1983-86
	465	C849992-F213244	1990-92
465 (GEN V)	C849992-F213244	1992-94	

	MOD.	S/N	
GM V8 427, 454, 502, 540 Et 572 (STERN DRIVE)	500 (GEN V)	F213293-F745159	1994-96
	500 (GEN VI)	F745195-L001772	1997-98
	502 MAG BRAVO	C878221-D824588	1990-92
	502 MAG BRAVO (GEN V)	D824589-F114528	1992-93
	502 EFI (GEN V)	D840650-F802599	1993-96
	502 MAG MPI (GEN VI)	F802600-K999999	1996-97
	500 EFI	L001477+	1999
	502 MAG MPI (GEN VI)	L085433+	1998
	600 SC	D456489-F877642	1991-92
	600 SC (GEN V)	D456489-F877642	1992-96
	600 SC (GEN VI)	K000227+	1997
	500 BULLDOG	C577254-F745405	1990-96
	500 BULLDOG	K000248+	1997
	575	A677429-D763716	1986-92
	800 SC (GEN V)	D763836+	1993-96
MCM 4, 5, 6 Et V8 CYL. DIESEL (STERN DRIVE ENGINE)	ROVER 60HP	3140000F+	1965-67
	530 D-TA 150 HP	B993000-B993492	1989
	636 D-TA 180 HP	B993500-C696047	1989
	D183 140 HP	B993493-D725149	1990-93
	D219 170 HP	C696048-D850124	1990-93
	D254 200 HP	C849484-D554729	1990-93
	D3.0L 140 HP	D725150+	1994
	D3.6L 170 HP	D850125+	1994
	D4.2L 200 HP	D554730+	1994
	D7.3L 238 HP	F060000+	1994
MERCURY MARINE MIE 4 CYL (INBOARD)	470	5520115-6218036	1980-81
	198	4762210-6218461	1977
	228	4765100-5170008	1977-78
	228	5170009-5907057	1978-80
	230/5.0L (4 BBL)	5907058-B788151	1981-87
	225	2278647-2694014	1968
	250	2314301-2639854	1968-69
	255	4175500-5907057	1975-80
	260/5.7L	5907058-F024999	1981-93
	270	2851074-3077735	1969-72
	5.7L	F025000-K999999	1994-97
	5.7L (GEN+)	L002003+	1998
	5.7L MPI	K040300-K999999	1997
	350 MAG MPI (GEN+)	L002008-L304499	1998
	350 MAG MPI (GEN+)	L304500+	1999
	350 HORIZON	L304700+	1999
	5.7L SKI	A338533-B514626	1985-87
	5.7L COMPETITION SKI	B514627-F775199	1987-95
	5.7L COMPETITION SKI	F775200-K040003	1996
	5.7L COMPETITION SKI	K040004-K999999	1997
5.7L COMPETITION SKI (GEN+)	L002005+	1998	
350 MAG SKI	D505454-K999999	1991-97	
350 MAG EFI SKI	F215561-K999999	1994-97	
350 MAG MPI SKI	F350583-F799999	1995-98	
BLACK SCORPION SKI	F800000+	1996-98	
GM MIE V8 305, 327, 350 CID (INBOARD)	325	2278747-3780449	1968-74
	330	4623115-5889913	1977-80
	340/7.4L W/B/W MK4	5889914	1981-92
	7.4L W/HURTH (LH) MK4	C391564-D715493	1989-92
	7.4L (LH)	D715494-K999999	1992-97
	7.4L MPI (LH)	F563050-K999999	1995-97
	7.4L MPI (L29) (GEN VI)	L002006+	1998
	7.4L TBI (LH) (GEN VI)	F874815-K999999	1996-97
	454 MAG MPI HORIZON	L002200-L086049	1998-99
	454 EFI (SKI) (GEN V)	F215800-F820099	1995-96
	454 MAG MPI (SKI) (GEN VI)	F820100-K999999	1996-97
	350	9780450-4623109	1974-76
	390	2781129-2825059	1969-70
	8.2L W/HURTH	C878221-D857199	1990-92
	8.2L (GEN V)	D857200-F819619	1993-96
	8.2L MPI (LH) (GEN VI)	F819620-K999999	1996-97
	8.2L MPI (LH) (GEN VI)	L002450-L0086012	1998
	8.2L MPI (LH) (GEN VI)	L0086013+	1999

	MOD.	S/N	
FORD MIE V8 (INBOARD)	215	2781153-3563181	1970-72
	225	3385721-4176999	1970-72
	233	4173000-4775784	1975-76
	255	3258728-4178299	1973-74
MIE 5, 6 Et V8 CYL. DIESEL INBOARD ENGINES	530 D-TA 150 HP	B993002-C539258	1989
	636 D-TA 180 HP	B993750-C696011	1989
	D183 150 HP	C539259-D725149	1990-93
	D219 180 HP	C696012-D850124	1990-93
	D254 210 HP	C849461-D554729	1990-93
	D3.0L 150 HP	D725150+	1994
	D3.6L 180 HP	D850125+	1994
D4.2L 210 HP	D554730+	1994	
D7.3L 262 HP	F060000+	1994	
MC 60, 80 Et 90 STERN DRIVES Et TRANSOM PLATES	60 (O)	1830753-2063740	1965-66
	80	2063741-2898029	1966-69
	90	2898020-3225967	1970-72
MC I, II Et III	I	1534570-1684187	1963
	II (1.33:1)	1474909-2278488	1962-67
	II (1.78:1)	2398798-2671321	1968-69
	III	2373127-3002613	1968-72
MC 1A, 1B Et 1C	III	5128065	1978
	1A, 1B Et 1C	1684188-1777798	1964
MC 120, 140, 160 Et 165	1A, 1B Et 1C (E-Z SHIFT)	1776349-2065189	1965-66
	120/140	2062141-378049	1967-73
	120/140	3780850-4893634	1974-77
	120/140	4893635-6225576	1978-82
	160	2065190-2763441	1967-69
	165	2763442-3780849	1970-73
	165	3780849-4890459	1974-77
	165	4890460-6268064	1978-82
	470	4208730-4893830	1976-77
	470 Et 485	4893835-6225576	1978-82
MC 470 Et 485	485	5487437-6225576	1980-82
	888	3106717-3784374	1971-73
	888	3784375-4782329	1974-77
	225S	3856268-4200499	1974
MC 488, 225S Et 233	225S	4200500-4782329	1975-77
	898/228	4782330-4898729	1977
	898/228	4898730-6229157	1978-82
MC 898, 228, 250 Et 260	250	4791300-4898729	1977
	260	4898730-6229157	1978-82
	R	6152230-6847029	1983-84
MC R, MR, ALPHA ONE, ALPHA ONE SS Et ALPHA ONE GEN II	MR	6810538-A479506	1985
	ALPHA ONE	A470165+	1986-90
	ALPHA ONE SS	A545004+	1986-89
	ALPHA ONE GEN II	D469859+	1991
	BRAVO ONE	B664190+	1988
MC BRAVO Et BLACKHAWK	BRAVO TWO	C564952+	1989
	BRAVO THREE	D763691+	1993
	BLACKHAWK	F186717+	1994
MC 215E Et 215 H	215 H	2782203-2909034	1970
	215 E	2782203-2909034	1970-72
MC TR Et TRS	TR	3377316-3787239	1973
	TR	3787240-4794899	1974-76
	TR	4794900-5009866	1977
	TR	5009867	1978
	TRS	3787240-4203749	1974-75
	TRS	4203750-4795399	1976
	TRS	4795400	1977

GUÍA
MANTENIMIENTO DE
MOTORES

ENGIEN MAINTENANCE
GUIDE

GUIDA
MANUTENZIONE
MOTORI

GUIDE
MAINTENANCE
MOTEURS



	REF					UN.	
3.0L GM181 I/L4 1987+ (0B450801+)	NGKBR6FS	(-0L096999)	BUJIA	SPARK PLUG	CANDELE	BOUGIE	4
	NGKBPR6EFS	(0L097000+)	BUJIA	SPARK PLUG	CANDELE	BOUGIE	4
	REC3852106	(-0L382121)	CORREA ALTERNADOR	ALTERNATOR BELT	CINGHIA ALTERNATORE	COURROIE ALTERNATEUR	1
	RM57-862054Q	(0L382122+)	CORREA ALTERNADOR (dirección hidráulica)	ALTERNATOR BELT (hydraulic steering)	CINGHIA ALTERNATORE (sterzo idraulico)	COURROIE ALTERNATEUR (direction hydraulique)	1
	REC57-49043A1		CORREA ALTERNADOR (sin dirección hidráulica)	ALTERNATOR BELT (without hydraulic steering)	CINGHIA ALTERNATORE (senza sterzo idraulico)	COURROIE ALTERNATEUR (sans direction hydraulique)	1
	REC57-65607Q		CORREA DIRECCIÓN HIDRAULICA	HYDRAULIC STEERING BELT	CINGHIA STERZO IDRAULICO	COURROIE DIRECTION HYDRAULIQUE	1
	REC59078Q3	(-0L340999)	TERMOSTATO	THERMOSTAT	TERMOSTATO	THERMOSTAT	1
	REC8M0091470	(0L341000+)	TERMOSTATO (Enfriador cerrado)	THERMOSTAT (closed cooling)	TERMOSTATO (raffreddamento chiuso)	THERMOSTAT (refroidisseur fermé)	1
	REC35-06003		FILTRO ACEITE	OIL FILTER	FILTRO OLIO	FILTRE D'HUILE	1
	REC25W40U3		ACEITE MOTOR	OIL	OLIO MOTORE	HUILE MOTEUR	1
3.0LX GM181 I/L4 (1990-1997) (0C856569 - 0K999999)	NGKBR6FS	(-0F603999)	BUJIA	SPARK PLUG	CANDELE	BOUGIE	4
	NGKBPR6EFS	(0F604000+)	BUJIA	SPARK PLUG	CANDELE	BOUGIE	4
	REC57-49043A1		CORREA ALTERNADOR (1 polea groove)	ALTERNATOR BELT (1 groove pulley)	CINGHIA ALTERNATORE (1 puleggia groove)	COURROIE ALTERNATEUR (1 poulie groove)	1
	REC3852106		CORREA ALTERNADOR (3 poleas groove)	ALTERNATOR BELT (3 groove pulley)	CINGHIA ALTERNATORE (3 puleggia groove)	COURROIE ALTERNATEUR (3 poulies groove)	1
	REC59078Q3		TERMOSTATO	THERMOSTAT	TERMOSTATO	THERMOSTAT	1
	REC8M0091470		TERMOSTATO (Enfriador cerrado)	THERMOSTAT (closed cooling)	TERMOSTATO (raffreddamento chiuso)	THERMOSTAT (refroidisseur fermé)	1
	REC57-65607Q		FILTRO ACEITE	OIL FILTER	FILTRO OLIO	FILTRE D'HUILE	1
	REC35-06003		FILTRO ACEITE	OIL FILTER	FILTRO OLIO	FILTRE D'HUILE	1
	REC25W40U3		ACEITE MOTOR	OIL	OLIO MOTORE	HUILE MOTEUR	1
	3.0 MPI EC (1A072812+)	NGKTR6IX		BUJIA	SPARK PLUG	CANDELE	BOUGIE
RM57-862054Q			CORREA ALTERNADOR	ALTERNATOR BELT	CINGHIA ALTERNATORE	COURROIE ALTERNATEUR	1
REC8M0091470			TERMOSTATO	THERMOSTAT	TERMOSTATO	THERMOSTAT	1
REC57-65607Q			CORREA DIRECCIÓN HIDRAULICA (940 mm)	HYDRAULIC STEERING BELT (940 mm)	CINGHIA STERZO IDRAULICO (940 mm)	COURROIE DIRECTION HYDRAULIQUE (940 mm)	1
REC35-06003			FILTRO ACEITE	OIL FILTER	FILTRO OLIO	FILTRE D'HUILE	1
RM35-866594Q01			FILTRO GASOLINA	FUEL FILTER	FILTRO BENZINA	FILTRE ESSENCE	1
REC25W40U3			ACEITE MOTOR	OIL	OLIO MOTORE	HUILE MOTEUR	1
3.0L TKS Plus (1G404114)	NGKBPR6EFS		BUJIA	SPARK PLUG	CANDELE	BOUGIE	4
	RM57-862054Q		CORREA ALTERNADOR	ALTERNATOR BELT	CINGHIA ALTERNATORE	COURROIE ALTERNATEUR	1
	REC8M0091470		TERMOSTATO	THERMOSTAT	TERMOSTATO	THERMOSTAT	1
	REC35-06003		FILTRO ACEITE	OIL FILTER	FILTRO OLIO	FILTRE D'HUILE	1
	REC25W40U3		ACEITE MOTOR	OIL	OLIO MOTORE	HUILE MOTEUR	1
	REC35-06003		FILTRO ACEITE	OIL FILTER	FILTRO OLIO	FILTRE D'HUILE	1
4.3L (GEN II) (1992-96) (0D714107 - 0F802999)	NGKBR6FS		BUJIA	SPARK PLUG	CANDELE	BOUGIE	6
	REC829207		CORREA ALTERNADOR (46")	ALTERNATOR BELT (46")	CINGHIA ALTERN. (46")	COURROIE ALTERN. (46")	1
	REC57-816295Q		CORREA DIRECCION HIDRAULICA	HYDRAULIC STEERING BELT	CINGHIA STERZO IDRAULICO	COURROIE DIRECTION HYDRAULIQUE	1
	REC8M0089715		TERMOSTATO 140°	THERMOSTAT 140°	TERMOSTATO 140°	THERMOSTAT 140°	1
	REC8M0091470		TERMOSTATO 160°	THERMOSTAT 160°	TERMOSTATO 160°	THERMOSTAT 160°	1
	REC35-06004		FILTRO ACEITE	OIL FILTER	FILTRO OLIO	FILTRE D'HUILE	1
	REC35-06003		FILTRO ACEITE (filtro remoto)	OIL FILTER (remote filter)	FILTRO OLIO (filtro remoto)	FILTRE D'HUILE (filter à distance)	1
	REC35-802893Q01		FILTRO GASOLINA	FUEL FILTER	FILTRO BENZINA	FILTRE D'ESSENCE	1
	REC25W40U3		ACEITE MOTOR	OIL	OLIO MOTORE	HUILE MOTEUR	2
	4.3L & LX (GEN +) (1996-98) (0F803000 - 0M614999)	NGKBR6FS		BUJIA	SPARK PLUG	CANDELE	BOUGIE
REC8M0089715			TERMOSTATO 140°	THERMOSTAT 140°	TERMOSTATO 140°	THERMOSTAT 140°	1
REC8M0091470			TERMOSTATO 160°	THERMOSTAT 160°	TERMOSTATO 160°	THERMOSTAT 160°	1
REC35-06004			FILTRO ACEITE	OIL FILTER	FILTRO OLIO	FILTRE D'HUILE	1
REC35-06003			FILTRO ACEITE (filtro remoto)	OIL FILTER (remote filter)	FILTRO OLIO (filtro remoto)	FILTRE D'HUILE (filter à distance)	1
REC35-802893Q			FILTRO GASOLINA	FUEL FILTER	FILTRO BENZINA	FILTRE D'ESSENCE	1
REC47-59362Q01		BRAVO	IMPULSOR	IMPELLER	GIRANTE	TURBINE	1
REC25W40U3			ACEITE MOTOR	OIL	OLIO MOTORE	HUILE MOTEUR	1
4.3L CARB. ALPHA/ BRAVO (0M61500+)	NGKBPR6EFS		BUJIA	SPARK PLUG	CANDELE	BOUGIE	6
	REC8M0089715		TERMOSTATO 140°	THERMOSTAT 140°	TERMOSTATO 140°	THERMOSTAT 140°	1
	REC8M0091470		TERMOSTATO 160°	THERMOSTAT 160°	TERMOSTATO 160°	THERMOSTAT 160°	1
	REC864493		TERMOSTATO 170° (enfriador cerrado)	THERMOSTAT 170° (closed cooling)	TERMOSTATO 170° (raffreddamento chiuso)	THERMOSTAT 170° (refroidisseur fermé)	1
	REC35-06004		FILTRO ACEITE	OIL FILTER	FILTRO OLIO	FILTRE D'HUILE	1
	REC35-06003		FILTRO ACEITE (filtro remoto)	OIL FILTER (remote filter)	FILTRO OLIO (filtro remoto)	FILTRE D'HUILE (filter à distance)	1
	REC35-802893Q01		FILTRO GASOLINA	FUEL FILTER	FILTRO BENZINA	FILTRE D'ESSENCE	1
	REC47-59362Q01	BRAVO	IMPPELLER STD (enfriador)	IMPELLER STD (cooling)	GIRANTE STD (raffreddamento)	TURBINE STD (refroidisseur)	1
	REC47-862232A2	BRAVO	IMPPELLER (enfriador cerrado)	IMPELLER (closed cooling)	GIRANTE (raffreddamento chiuso)	TURBINE (refroidisseur fermé)	1
	REC57-865615Q04	ALPHA	CORREA (dirección asistida)	BELT (power steering)	CINGHIA (servosterzo)	COURROIE (direction assistée)	1
	REC57-865615Q03	BRAVO	CORREA (dirección asistida)	BELT (power steering)	CINGHIA (servosterzo)	COURROIE (direction assistée)	1
	REC57-865615Q08	BRAVO	CORREA (dirección hidráulica compacta)	BELT (compact hydraulic steering)	CINGHIA (sterzo idraulico compatto)	COURROIE (direction hydraulique compacte)	1
	REC25W40U3		ACEITE MOTOR	OIL	OLIO MOTORE	HUILE MOTEUR	2





REF

UN.

4.3L EFI (GEN+) TBI (0L619000- 0L618999)	NGKBPR6EFS	BUJIA	SPARK PLUG	CANDELE	BOUGIE		
	REC8M0089715	TERMOSTATO 140°	THERMOSTAT 140°	TERMOSTATO 140°	THERMOSTAT 140°		
	REC8M0091470	TERMOSTATO 160°	THERMOSTAT 160°	TERMOSTATO 160°	THERMOSTAT 160°		
	REC35-06004	FILTRO ACEITE	OIL FILTER	FILTRO OLIO	FILTRE D'HUILE		
	REC35-06003	FILTRO ACEITE (filtro remoto)	OIL FILTER (remote filter)	FILTRO OLIO (filtro remoto)	FILTRE D'HUILE (filtre à distance)		
	REC35-802893Q01	FILTRO GASOLINA	FUEL FILTER	FILTRO BENZINA	FILTRE D'ESSENCE		
	REC47-59362Q01	IMPULSOR	IMPELLER	GIRANTE	TURBINE		
	REC25W40U3	ACEITE MOTOR	OIL	OLIO MOTORE	HUILE MOTEUR		
	194	CORREAS	BELT	CINGHIE	COURROIES		
4.3L MPI ALPHA/ BRAVO & EC MODELS (ALL SERIES) (0M300000+)	NGKTR6IX	BUJIA	SPARK PLUG	CANDELE	BOUGIE	6	
	REC8M0089715	TERMOSTATO 140°	THERMOSTAT 140°	TERMOSTATO 140°	THERMOSTAT 140°	1	
	REC8M0091470	TERMOSTATO 160°	THERMOSTAT 160°	TERMOSTATO 160°	THERMOSTAT 160°	1	
	REC864493	TERMOSTATO 170° (enfriador cerrado)	THERMOSTAT 170° (closed cooling)	TERMOSTATO 170° (raffreddamento chiuso)	THERMOSTAT 170° (refroidisseur fermé)	1	
	REC35-06004	FILTRO ACEITE	OIL FILTER	FILTRO OLIO	FILTRE D'HUILE	1	
	REC35-06003	FILTRO ACEITE (filtro remoto)	OIL FILTER (remote filter)	FILTRO OLIO (filtro remoto)	FILTRE D'HUILE (filtre à distance)	1	
	REC35-802893Q01	FILTRO GASOLINA	FUEL FILTER	FILTRO BENZINA	FILTRE D'ESSENCE	1	
	REC47-862232A2	IMPULSOR	IMPELLER	GIRANTE	TURBINE	1	
REC25W40U3	ACEITE MOTOR	OIL	OLIO MOTORE	HUILE MOTEUR	2		
	194	CORREAS	BELT	CINGHIE	COURROIES		
4.5L MPI ALPHA/ BRAVO (2A441953+)	NGKBPR5EFS-13	BUJIA	SPARK PLUG	CANDELE	BOUGIE	6	
	REC864493	TERMOSTATO 170° (intercambiador de calor)	THERMOSTAT 170° (heat exchanger)	TERMOSTATO 170° (scambiatore di calore)	THERMOSTAT 170° (échangeur de chaleur)	1	
	REC8M0089715	TERMOSTATO 140°	THERMOSTAT 140°	TERMOSTATO 140°	THERMOSTAT 140°	1	
	REC35-06003	FILTRO ACEITE	OIL FILTER	FILTRO OLIO	FILTRE D'HUILE	1	
	RAC31871	FILTRO GASOLINA	FUEL FILTER	FILTRO BENZINA	FILTRE D'ESSENCE	1	
	REC47-862232A2	IMPULSOR	IMPELLER	GIRANTE	TURBINE	1	
	REC25W40U3	ACEITE MOTOR	OIL	OLIO MOTORE	HUILE MOTEUR	2	
		194	CORREAS	BELT	CINGHIE	COURROIES	
5.0L (1988-95) (0B774445 - 0F600999)	NGKBR6FS	BUJIA	SPARK PLUG	CANDELE	BOUGIE	8	
	REC8M0089715	TERMOSTATO 140°	THERMOSTAT 140°	TERMOSTATO 140°	THERMOSTAT 140°	1	
	REC8M0091470	TERMOSTATO 160°	THERMOSTAT 160°	TERMOSTATO 160°	THERMOSTAT 160°	1	
	REC35-06003	FILTRO ACEITE	OIL FILTER	FILTRO OLIO	FILTRE D'HUILE	1	
	REC35-802893Q01	FILTRO GASOLINA	FUEL FILTER	FILTRO BENZINA	FILTRE D'ESSENCE	1	
	REC47-59362Q01	IMPULSOR (enfriador cerrado)	IMPELLER (closed cooling)	GIRANTE (raffreddamento chiuso)	TUBINE (refroidisseur fermé)	1	
	REC57-13457Q	CORREA BOMBA DE AGUA	WATER PUMP BELT	CINGHIA POMPA DELL'ACQUA	COURROIE POMPE D'EAU	1	
	REC57-34359	CORREA (dirección hidráulica)	BELT (hydraulic steering)	CINGHIA (sterzo idraulico)	COURROIE (direction hydraulique)	1	
	REC3858462	CORREA ALTERN. (44")	ALTERNATOR BELT (44")	CINGHIA ALTERN. (44")	COURROIE ALTERN. (44")	1	
	REC829207	CORREA ALTERN. (46")	ALTERNATOR BELT (46")	CINGHIA ALTERN. (46")	COURROIE ALTERN. (46")	1	
	REC25W40U3	ACEITE MOTOR	OIL	OLIO MOTORE	HUILE MOTEUR	2	
		194	CORREAS	BELT	CINGHIE	COURROIES	
5.0L & 5.0L EFI (1998-01) (0L015751 - 0M599999)	NGKBPR6EFS	BUJIA	SPARK PLUG	CANDELE	BOUGIE	8	
	REC8M0089715	TERMOSTATO 140°	THERMOSTAT 140°	TERMOSTATO 140°	THERMOSTAT 140°	1	
	REC8M0091470	TERMOSTATO 160°	THERMOSTAT 160°	TERMOSTATO 160°	THERMOSTAT 160°	1	
	REC99155T2	TERMOSTATO 170° (enfriador cerrado)	THERMOSTAT 170° (closed cooling)	TERMOSTATO 170° (raffreddamento chiuso)	THERMOSTAT 170° (refroidisseur fermé)	1	
	REC35-06003	FILTRO ACEITE	OIL FILTER	FILTRO OLIO	FILTRE D'HUILE	1	
	REC35-802893Q01	FILTRO GASOLINA	FUEL FILTER	FILTRO BENZINA	FILTRE D'ESSENCE	1	
	REC47-59362Q01	IMPULSOR	IMPELLER	GIRANTE	TURBINE	1	
	REC25W40U3	ACEITE MOTOR	OIL	OLIO MOTORE	HUILE MOTEUR	2	
		194	CORREAS	BELT	CINGHIE	COURROIES	
	5.0L CARB. ALPHA/ BRAVO (0M600000+)	NGKBPR6EFS	BUJIA	SPARK PLUG	CANDELE	BOUGIE	8
		REC8M0089715	TERMOSTATO 140°	THERMOSTAT 140°	TERMOSTATO 140°	THERMOSTAT 140°	1
		REC8M0091470	TERMOSTATO 160°	THERMOSTAT 160°	TERMOSTATO 160°	THERMOSTAT 160°	1
REC35-06003		FILTRO ACEITE	OIL FILTER	FILTRO OLIO	FILTRE D'HUILE	1	
REC35-802893Q		FILTRO GASOLINA	FUEL FILTER	FILTRO BENZINA	FILTRE D'ESSENCE	1	
REC47-59362Q01		IMPULSOR	IMPELLER	GIRANTE	TURBINE	1	
REC57-865615Q04		CORREA (dirección asistida)	BELT (power steering)	CINGHIA (servosterzo)	COURROIE (direction assistée)	1	
REC57-865615Q03		CORREA (dirección asistida)	BELT (power steering)	CINGHIA (servosterzo)	COURROIE (direction assistée)	1	
REC57-865615Q08		CORREA (sin dirección asistida)	BELT (without power steering)	CINGHIA (senza servosterzo)	COURROIE (sans direction assistée)	1	
REC25W40U3		ACEITE MOTOR	OIL	OLIO MOTORE	HUILE MOTEUR	2	
	194	CORREAS	BELT	CINGHIE	COURROIES		
5.0L MPI ALPHA/ BRAVO & EC (0M300000+)	NGKITR4A15	BUJIA	SPARK PLUG	CANDELE	BOUGIE	8	
	REC8M0089715	TERMOSTATO 140°	THERMOSTAT 140°	TERMOSTATO 140°	THERMOSTAT 140°	1	
	REC8M0091470	TERMOSTATO 160°	THERMOSTAT 160°	TERMOSTATO 160°	THERMOSTAT 160°	1	
	REC99155T2	TERMOSTATO 160° (drenaje fácil)	THERMOSTAT 160° (easy drain)	TERMOSTATO 160° (scarico facile)	THERMOSTAT 160° (vidange facile)	1	
	REC864493	TERMOSTATO 170° (drenaje fácil)	THERMOSTAT 170° (easy drain)	TERMOSTATO 170° (scarico facile)	THERMOSTAT 170° (vidange facile)	1	
	REC35-06003	FILTRO ACEITE	OIL FILTER	FILTRO OLIO	FILTRE D'HUILE	1	
	REC35-802893Q	FILTRO GASOLINA	FUEL FILTER	FILTRO BENZINA	FILTRE D'ESSENCE	1	
	REC35-866171A01	FILTRO GASOLINA (módulo gasolina)	FUEL FILTER (fuel module)	FILTRO BENZINA (modulo benzina)	FILTRE D'ESSENCE (module à essence)	1	
	REC35-892665	FILTRO GASOLINA (módulo gasolina)	FUEL FILTER (fuel module)	FILTRO BENZINA (modulo benzina)	FILTRE D'ESSENCE (module à essence)	1	
	REC47-862232A2	IMPULSOR	IMPELLER	GIRANTE	TURBINE	1	
	REC25W40U3	ACEITE MOTOR	OIL	OLIO MOTORE	HUILE MOTEUR	2	
		194	CORREAS	BELT	CINGHIE	COURROIES	

	REF					UN.
5.7L CARB. ALPHA/ BRAVO & LX/ EFI (1998+) (OB525982 +)	NGKBR6EFS (-OK999999)	BUJIA	SPARK PLUG	CANDELE	BOUGIE	8
	NGKBR6EFS (OL010037+)	BUJIA	SPARK PLUG	CANDELE	BOUGIE	8
	REC8M0089715	TERMOSTATO 140°	THERMOSTAT 140°	TERMOSTATO 140°	THERMOSTAT 140°	1
	REC8M0091470	TERMOSTATO 160°	THERMOSTAT 160°	TERMOSTATO 160°	THERMOSTAT 160°	1
	REC99155T2	TERMOSTATO (enfriador cerrado)	THERMOSTAT (closed cooling)	TERMOSTATO (raffreddamento chiuso)	THERMOSTAT (refroidisseur fermé)	1
	REC35-06003	FILTRO ACEITE	OIL FILTER	FILTRO OLIO	FILTRE D'HUILE	1
	REC35-802893Q	FILTRO GASOLINA	FUEL FILTER	FILTRO BENZINA	FILTRE D'ESSENCE	1
	REC47-59362Q01 BRAVO	IMPULSOR	IMPELLER	GIRANTE	TURBINE	1
	REC25W40U3	ACEITE MOTOR	OIL	OLIO MOTORE	HUILE MOTEUR	2
		CORREAS	BELT	CINGHIE	COURROIES	
350 MAG & 350 MAG EFI (GEN+) (1986+) (OA635178 - OK999999)	NGKBR6FS	BUJIA	SPARK PLUG	CANDELE	BOUGIE	8
	NGKBR6EFS EFI	BUJIA	SPARK PLUG	CANDELE	BOUGIE	8
	REC35-802893Q	FILTRO GASOLINA	FUEL FILTER	FILTRO BENZINA	FILTRE D'ESSENCE	1
	REC65L-13915-00 EFI	FILTRO GASOLINA VST	FUEL FILTER VST	FILTRO BENZINA VST	FILTRE D'ESSENCE VST	1
	REC35-06003	FILTRO ACEITE	OIL FILTER	FILTRO OLIO	FILTRE D'HUILE	1
	REC8M0089715	TERMOSTATO 140°	THERMOSTAT 140°	TERMOSTATO 140°	THERMOSTAT 140°	1
	REC8M0091470	TERMOSTATO 160°	THERMOSTAT 160°	TERMOSTATO 160°	THERMOSTAT 160°	1
	REC47-59362Q01 BRAVO	IMPULSOR	IMPELLER	GIRANTE	TURBINE	1
	REC25W40U3	ACEITE MOTOR	OIL	OLIO MOTORE	HUILE MOTEUR	2
		CORREAS	BELT	CINGHIE	COURROIES	
350 MAG/MPI (OF415189+)	NGKBR6EFS (-OF601999)	BUJIA	SPARK PLUG	CANDELE	BOUGIE	8
	NGKTR6IX (OF602000 - OM299999)	BUJIA	SPARK PLUG	CANDELE	BOUGIE	8
	NGKITR4A15 (OM300000+)	BUJIA	SPARK PLUG	CANDELE	BOUGIE	8
	REC35-802893Q	FILTRO GASOLINA	FUEL FILTER	FILTRO BENZINA	FILTRE D'ESSENCE	1
	REC65L-13915-00 (-OM299999)	FILTRO GASOLINA VST	FUEL FILTER VST	FILTRO BENZINA VST	FILTRE D'ESSENCE VST	1
	REC864572 (OM300000 - OW059999)	FILTRO GASOLINA IN-LINE	FUEL FILTRO IN-LINE	FILTRO BENZINA IN-LINE	FILTRE D'ESSENCE IN-LINE	1
	REC35-866171A01 (OW060000+)	FILTRO GASOLINA VST	FUEL FILTER VST	FILTRO BENZINA VST	FILTRE D'ESSENCE VST	1
	REC35-892665 (OW060000+)	FILTRO GASOLINA VST	FUEL FILTER VST	FILTRO BENZINA VST	FILTRE D'ESSENCE VST	1
	REC35-06003	FILTRO ACEITE	OIL FILTER	FILTRO OLIO	FILTRE À HUILE	1
	REC47-59362Q01 BRAVO (-OM299999)	IMPULSOR	IMPELLER	GIRANTE	TURBINE	1
	REC47-862232A2 (OM300000+)	IMPULSOR	IMPELLER	GIRANTE	TURBINE	1
	REC8M0089715	TERMOSTATO 140°	THERMOSTAT 140°	TERMOSTATO 140°	THERMOSTAT 140°	1
	REC8M0091470	TERMOSTATO 160°	THERMOSTAT 160°	TERMOSTATO 160°	THERMOSTAT 160°	1
	REC99155T2	TERMOSTATO 160° (drenaje fácil y enfriador cerrado)	THERMOSTAT 160° (easy drain & closing cooling)	TERMOSTATO 160° (scarico facile e raffreddamento chiuso)	THERMOSTAT 160° (vidange facile et refroidisseur fermé)	1
	REC25W40U3	ACEITE MOTOR	OIL	OLIO MOTORE	HUILE MOTEUR	2
		CORREAS	BELT	CINGHIE	COURROIES	
	6.2L MPI & 377 MAG MPI (OL302200+)	NGKTR6IX (OL302200 - OM299999)	BUJIA	SPARK PLUG	CANDELE	BOUGIE
NGKITR4A15 (OM310000+)		BUJIA	SPARK PLUG	CANDELE	BOUGIE	8
NGKITR4A15 (OM300000+)		BUJIA	SPARK PLUG	CANDELE	BOUGIE	8
REC35-802893Q		FILTRO GASOLINA	FUEL FILTER	FILTRO BENZINA	FILTRE D'ESSENCE	1
REC864572 (OM311053+)		FILTRO GASOLINA IN-LINE	FUEL FILTRO IN-LINE	FILTRO BENZINA IN-LINE	FILTRE D'ESSENCE IN-LINE	1
REC35-866171A01 (OM398395+)		FILTRO GASOLINA VST	FUEL FILTER VST	FILTRO BENZINA VST	FILTRE D'ESSENCE VST	1
REC35-892665 (OM398395+)		FILTRO GASOLINA VST	FUEL FILTER VST	FILTRO BENZINA VST	FILTRE D'ESSENCE VST	1
REC35-06003		FILTRO ACEITE	OIL FILTER	FILTRO OLIO	FILTRE À HUILE	1
REC016940 HURT/ZEUS		FILTRO ACEITE TRANSMISION	OIL FILTER TRANSMISSION	FILTRO OLIO TRASMISSIONE	FILTRE À HUILE DE TRANSMISSION	1
REC47-59362Q01 (OL302200 - OM299999)		IMPULSOR	IMPELLER	GIRANTE	TURBINE	1
REC47-862232A2 (OM310000+)		IMPULSOR	IMPELLER	GIRANTE	TURBINE	1
REC8M0089715		TERMOSTATO 140°	THERMOSTAT 140°	TERMOSTATO 140°	THERMOSTAT 140°	1
REC8M0091470		TERMOSTATO 160°	THERMOSTAT 160°	TERMOSTATO 160°	THERMOSTAT 160°	1
REC99155T2 (-OM316999)		TERMOSTATO (drenaje fácil y enfriador cerrado)	THERMOSTAT (easy drain & closing cooling)	TERMOSTATO (scarico facile e raffreddamento chiuso)	THERMOSTAT (vidange facile et refroidisseur fermé)	1
REC864493 (OM317000+)		TERMOSTATO (drenaje fácil y enfriador cerrado)	THERMOSTAT (easy drain & closing cooling)	TERMOSTATO (scarico facile e raffreddamento chiuso)	THERMOSTAT (vidange facile et refroidisseur fermé)	1
REC25W40U3		ACEITE MOTOR	OIL	OLIO MOTORE	HUILE MOTEUR	2
		CORREAS	BELT	CINGHIE	COURROIES	
(1988+) (GEN V&VI) (OM771113 - OM024330)	NGKBR6FS (OK999999-)	BUJIA	SPARK PLUG	CANDELE	BOUGIE	8
	NGKBR6EFS (OL010003 - OM024330)	BUJIA	SPARK PLUG	CANDELE	BOUGIE	8
	NGKBR6FVX MPI HORIZON	BUJIA	SPARK PLUG	CANDELE	BOUGIE	8
	REC35-802893Q	FILTRO GASOLINA	FUEL FILTER	FILTRO BENZINA	FILTRE D'ESSENCE	1
	REC65L-13915-00 (OF602010+)	FILTRO GASOLINA VST	FUEL FILTER VST	FILTRO BENZINA VST	FILTRE D'ESSENCE VST	1
	REC35-06003	FILTRO ACEITE	OIL FILTER	FILTRO OLIO	FILTRE À HUILE	1
	REC016940 HURT/ZEUS	FILTRO ACEITE TRANSMISION	OIL FILTER TRANSMISSION	FILTRO OLIO TRASMISSIONE	FILTRE À HUILE DE TRANSMISSION	1
	REC47-59362Q01	IMPULSOR	IMPELLER	GIRANTE	TURBINE	1
	REC8M0089715	TERMOSTATO 140°	THERMOSTAT 140°	TERMOSTATO 140°	THERMOSTAT 140°	1
	REC8M0091470	TERMOSTATO 160°	THERMOSTAT 160°	TERMOSTATO 160°	THERMOSTAT 160°	1
	REC99155T2	TERMOSTATO (drenaje fácil y enfriador cerrado)	THERMOSTAT (easy drain & closing cooling)	TERMOSTATO (scarico facile e raffreddamento chiuso)	THERMOSTAT (vidange facile et refroidisseur fermé)	1
	REC25W40U3	ACEITE MOTOR	OIL	OLIO MOTORE	HUILE MOTEUR	2
		CORREAS	BELT	CINGHIE	COURROIES	



	REF					UN.	
8.1L (0M0206000+)	NGKTR55IX	(-2006)	BUJIA	SPARK PLUG	CANDELE	BOUGIE	8
	NGKIZFR7M	(2007+)	BUJIA	SPARK PLUG	CANDELE	BOUGIE	8
	REC35-802893Q		FILTRO GASOLINA	FUEL FILTER	FILTRO BENZINA	FILTRE D'ESSENCE	1
	REC35-866171A01		FILTRO GASOLINA VST	FUEL FILTER VST	FILTRO BENZINA VST	FILTRE D'ESSENCE VST	1
	REC35-892665		FILTRO GASOLINA VST	FUEL FILTER VST	FILTRO BENZINA VST	FILTRE D'ESSENCE VST	1
	REC35-06003		FILTRO ACEITE	OIL FILTER	FILTRO OLIO	FILTRE À HUILE	1
	REC016940	HURT/ZEUS	FILTRO ACEITE TRANSMISION	OIL FILTER TRANSMISSION	FILTRO OLIO TRASMISSIONE	FILTRE À HUILE DE TRANSMISSION	1
	REC47-862232A2		IMPULSOR	IMPELLER	GIRANTE	TURBINE	1
	REC25W40U3		ACEITE MOTOR	OIL	OLIO MOTORE	HUILE MOTEUR	3
			CORREAS	BELT	CINGHIE	COURROIES	
8.2L (1A350802 - 2A041665)	NGKBPR6ES		BUJIA	SPARK PLUG	CANDELE	BOUGIE	8
	REC35-802893Q		FILTRO GASOLINA	FUEL FILTER	FILTRO BENZINA	FILTRE D'ESSENCE	1
	REC35-866171A01		FILTRO GASOLINA VST	FUEL FILTER VST	FILTRO BENZINA VST	FILTRE D'ESSENCE VST	1
	REC35-892665		FILTRO GASOLINA VST	FUEL FILTER VST	FILTRO BENZINA VST	FILTRE D'ESSENCE VST	1
	REC35-06003		FILTRO ACEITE	OIL FILTER	FILTRO OLIO	FILTRE À HUILE	1
	REC016940	HURT/ZEUS	FILTRO ACEITE TRANSMISION	OIL FILTER TRANSMISSION	FILTRO OLIO TRASMISSIONE	FILTRE À HUILE DE TRANSMISSION	1
	REC47-862232A2		IMPULSOR	IMPELLER	GIRANTE	TURBINE	1
	REC25W40U3		ACEITE MOTOR	OIL	OLIO MOTORE	HUILE MOTEUR	3
			CORREAS	BELT	CINGHIE	COURROIES	



	REF					UN.	
QSD 2.0 DIESEL	REC35-879172143		FILTRO AIRE	AIR FILTER	FILTRO ARIA	FILTRE D'AIR	
	REC35-879172104		FILTRO COMBUSTIBLE	DIESEL FILTER	FILTRO COMBUSTIBILE	FILTRE CARBURANT	
	REC879150054		TERMOSTATO	THERMOSTAT	TERMOSTATO	THERMOSTAT	
	REC57-879172120		CORREA	BELT	CINGHIE	COURROIE	
	TEN01320T		ANODO	ANODE	ANODO	ANODE	
	REC895207		FILTRO ACEITE (83mm)	OIL FILTER (83 mm)	FILTRO OLIO (83 mm)	FILTRE À HUILE (83 mm)	
	REC35-879312041		FILTRO ACEITE (67mm)	OIL FILTER (67 mm)	FILTRO OLIO (67 mm)	FILTRE À HUILE (67 mm)	
	REC15W40U3		ACEITE MOTOR	OIL	OLIO MOTORE	HUILE MOTEUR	
	JAB11979-0001	JABSCO	IMPULSOR	IMPELLER	GIRANTE	TURBINE	
	SHE10615K	SHERWOOD	IMPULSOR	IMPELLER	GIRANTE	TURBINE	
QSD 2.8 DIESEL	REC879172		FILTRO AIRE	AIR FILTER	FILTRO ARIA	FILTRE D'AIR	
	REC35-879172104		FILTRO COMBUSTIBLE	DIESEL FILTER	FILTRO COMBUSTIBILE	FILTRE CARBURANT	
	REC8M0093561		TERMOSTATO	THERMOSTAT	TERMOSTATO	THERMOSTAT	
	REC57-879194425		CORREA	BELT	CINGHIE	COURROIE	
	TEN01320T		ANODO	ANODE	ANODO	ANODE	
	REC895207		FILTRO ACEITE	OIL FILTER	FILTRO OLIO	FILTRE À HUILE	
	REC15W40U3		ACEITE MOTOR	OIL	OLIO MOTORE	HUILE MOTEUR	
	JAB11979-0001	JABSCO	IMPULSOR	IMPELLER	GIRANTE	TURBINE	
	SHE10615K	SHERWOOD	IMPULSOR	IMPELLER	GIRANTE	TURBINE	
	QSD 4.2 DIESEL	REC35-898272048		FILTRO AIRE	AIR FILTER	FILTRO ARIA	FILTRE D'AIR
REC35-879172104			FILTRO COMBUSTIBLE	DIESEL FILTER	FILTRO COMBUSTIBILE	FILTRE CARBURANT	
REC879150054			TERMOSTATO	THERMOSTAT	TERMOSTATO	THERMOSTAT	
REC57-898101579			CORREA	BELT	CINGHIE	COURROIE	
TEN01320T			ANODO	ANODE	ANODO	ANODE	
REC895207			FILTRO ACEITE	OIL FILTER	FILTRO OLIO	FILTRE À HUILE	
REC15W40U3			ACEITE MOTOR	OIL	OLIO MOTORE	HUILE MOTEUR	
JAB17937-0001-P		JABSCO	IMPULSOR	IMPELLER	GIRANTE	TURBINE	
SHE15000K		SHERWOOD	IMPULSOR	IMPELLER	GIRANTE	TURBINE	
3.0L V6 TDI DIESEL (TIER 3)		REC35-8M6002131		FILTRO AIRE	AIR FILTER	FILTRO ARIA	FILTRE D'AIR
	REC35-8M0067337		FILTRO COMBUSTIBLE	DIESEL FILTER	FILTRO COMBUSTIBILE	FILTRE CARBURANT	
	RECGS01030		FILTRO COMBUSTIBLE	DIESEL FILTER	FILTRO COMBUSTIBILE	FILTRE CARBURANT	
	REC8M0093480		TERMOSTATO	THERMOSTAT	TERMOSTATO	THERMOSTAT	
	REC57-8M0093495	Alt+ P.Steering	CORREA	BELT	CINGHIE	COURROIE	
	REC8M6002274		ANODO	ANODE	ANODO	ANODE	
	REC35-8M0066483		FILTRO ACEITE	OIL FILTER	FILTRO OLIO	FILTRE À HUILE	
	JAB17018-0001		IMPULSOR	IMPELLER	GIRANTE	TURBINE	

KITS MANTENIMIENTO COLAS

DRIVES MAINTENANCE KIT

KIT MANUTENZIONE PIEDE

KITS D'ENTRETIEN DES EMBASSES

		REF					
ALPHA ONE GEN I	RECKITALPHA1	REC60932A4	FUELLE TRANSON	U-JOINT BELOW	MANICOTTO TRANSON	SOUFFLET TRANSON	1
		REC54-815504320	ABRAZADERA INOX 32-50	HOSE CLAMP 32-50	FASCETTA INOX 32-50	COLLIER INOX 32-50	1
		REC47-89984Q5	KIT BOMBA AGUA	WATER PUMP KITS	KIT POMPA ACQUA	KIT POMPE À EAU	1
		RECKITMALPHA1AL	KIT ÁNODOS	ANODES KIT	KIT ANODI	KIT ANODES	1
		REC12-191833	JUNTA	GASKET	GUARNIZIONE	JOINT	2
		REC26-455771	RETÉN	SEAL	PARAOLIO	JOINT SPI	1
		REC18654A1	FUELLE ESCAPE	EXHAUST BELOW	MANICOTTO SCARICO	SOUFFLET ECHAPPEMENT	1
		REC27-94996Q2	KIT DE JUNTAS	GASKET KIT	KIT GUARNIZIONE	KIT JOINTS	1
ALPHA ONE GEN II	RECKITGENEII	REC816431A1	FUELLE TRANSON	U-JOINT BELOW	MANICOTTO TRANSON	SOUFFLET TRANSON	1
		REC54-815504320	ABRAZADERA INOX 32-50	HOSE CLAMP 32-50	FASCETTA INOX 32-50	COLLIER INOX 32-50	1
		REC12-191833	JUNTA	GASKET	GUARNIZIONE	JOINT	2
		REC26-455771	RETÉN	SEAL	PARAOLIO	JOINT SPI	1
		RECKITMALPHA2AL	KIT ÁNODOS	ANODES KIT	KIT ANODI	KIT ANODES	1
		REC47-43026Q06	KIT BOMBA AGUA	WATER PUMP KITS	KIT POMPA ACQUA	KIT POMPE À EAU	1
		REC53-815949	CIERRE METALICO	E-RING	CHIUSURA METALLICO	E-CLIP	2
		REC18654A1	FUELLE ESCAPE	EXHAUST BELOW	MANICOTTO SCARICO	SOUFFLET ECHAPPEMENT	1
REC27-94996Q2	KIT DE JUNTAS	GASKET KIT	KIT GUARNIZIONE	KIT JOINTS	1		
BRAVO	RECKITBRAVO	REC86840A05	FUELLE TRANSON	U-JOINT BELOW	MANICOTTO TRANSON	SOUFFLET TRANSON	1
		REC54-815504320	ABRAZADERA INOX 32-50	HOSE CLAMP 32-50	FASCETTA INOX 32-50	COLLIER INOX 32-50	1
		REC12-191833	JUNTA	GASKET	GUARNIZIONE	JOINT	2
		REC16755Q1	KIT DE JUNTAS	GASKET KIT	KIT GUARNIZIONE	KIT JOINTS	1
		RECKITBRAVO3AL	KIT ÁNODOS	ANODES KIT	KIT ANODI	KIT ANODES	1
		CM806188A	ÁNODO AL	ANODE AL	ANODO AL	ANODE AL	1
REC18654A1	FUELLE ESCAPE	EXHAUST BELOW	MANICOTTO SCARICO	SOUFFLET ECHAPPEMENT	1		

GUÍA MANTENIMIENTO TRANSMISIONES

GUIDE MAINTENANCE TRANSMISSIONS

GUIDA MANUTENZIONE TRANSMISSIONI

GUIDE MAINTENANCE TRANSMISSIONS

		REF					
TR/TRS (1977-93) (4794900+)		REC27-54014Q1	KIT JUNTAS TRANSON	TRANSON GASKET KIT	KIT GUARNIZIONE TRANSON	KIT JOINT TRANSON	1
		REC60932A4	FUELLE TRANSMISION	TRANSMISSION BELLOW	CUFFIA TRASMISSIONE	SOUFFLET CARDAN	1
		REC10-79953Q04	TAPON DE NIVEL ACEITE	OIL LEVEL CAP	TAPPO LIVELLO OLIO	BOUCHON DE NIVEAU D'HUILE	1
		REC10-79953Q04	TAPON DRENAJE ACEITE	OIL DRAIN CAP	TAPPO SCARICO OLIO	BOUCHON VIDANGE	1
		REC31640Q4AL	ANODO TIMON	RUDDER ANODE	ANODO TIMONE	ANODE DE TIMON	1
		REC80W90U6	ACEITE SINTETICO 80W-90	SYNTHETIC OIL 80W-90	OLIO SINTETICO 80W-90	HUILE SYNTHÉTIQUE 80W-90	2
R/ MR/ ALPHA ONE (1983-90) (6216687 - 0F386995)		REC27-94996Q2	KIT JUNTAS TRANSON	TRANSON GASKET KIT	KIT GUARNIZIONE TRANSON	KIT JOINT TRANSON	1
		REC30-879194A01	RODAMIENTO TRANSON	TRANSON BEARING	CUSCINETTO TRANSON	ROULEMENT TRANSON	1
		REC60932A4	FUELLE TRANSMISION	TRANSMISSION BELLOW	CUFFIA TRASMISSIONE	SOUFFLET CARDAN	1
		REC18654A1	FUELLE ESCAPE	EXHAUST BELLOW	CUFFIA DI SCARICO	SOUFFLET ECHAPPEMENT	1
		REC78458A1	FUELLE ESCAPE TUBO (454 MAG)	EXHAUST BELLOW TUBE (454 MAG)	CUFFIA DI SCARICO TUBO (454 MAG)	SOUFFLET ECHAPPEMENT TUBE (454 MAG)	1
		REC74639Q02	FUELLE CABLE CAMBIO	SHIFT WIRE BELLOW	CUFFIA CAVO CAMBIO	SOUFFLET CABLE CHANGEMENT	1
		REC10-79953Q04	TAPON DE NIVEL ACEITE	OIL LEVEL CAP	TAPPO LIVELLO OLIO	BOUCHON DE NIVEAU D'HUILE	1
		REC22-67892A05	TAPON DERENAJE ACEITE	OIL DRAIN CAP	TAPPO SCARICO OLIO	BOUCHON VIDANGE	1
		REC31640Q4AL	ANODO TIMON (2-3/8")	RUDDER ANODE (2-3/8")	ANODO TIMONE (2-3/8")	ANODE DE TIMON (2-3/8")	1
		REC55989Q9AL	ANODO TIMON (4")	RUDDER ANODE (4")	ANODO TIMONE (4")	ANODE DE TIMON (4")	1
		REC55989Q9AL	ANODO BOLA TRANSON	BALL ANODE TRANSON	ANODO BOLLA TRANSON	ANODE BALL TRANSON	1
		REC821631Q1AL	ANODO TRANSON (MERCAT)	TRANSON ANODE (MERCAT)	ANODO TRANSON (MERCAT)	ANODE TRANSON (MERCAT)	1
		CM43994	ANODO TRANSON (MERCAT) ANTIGUO	TRANSON ANODE (MERCAT) OLD	ANODO TRANSON (MERCAT) VECCHIO	ANODE TRANSON (MERCAT) ANCIEN	1
		RECKITMALPHA1AL	KIT ANODOS	ANODE KIT	KIT ANODI	KIT ANODES	1
		REC32-32461	TUBO AGUA 5/8" TRANSON	WATER TUBE 5/8" TRANSON	TUBO ACQUA 5/8" TRANSON	TUBE D'EAU 5/8" TRANSON	1
		REC32-4172533	TUBO AGUA 3/4" TRANSON	WATER TUBE 3/4" TRANSON	TUBO ACQUA 3/4" TRANSON	TUBE D'EAU 3/4" TRANSON	1
		REC47-89984T4	IMULSOR	IMPELLER	GIRANTE	TURBINE	1
		REC47-89984Q5	KIT BOMBA DE AGUA	WATER PUMP KIT	KIT POMPA ACQUA	KIT POMPE À EAU	1
		REC865436A03	KIT CABLE CAMBIO	SHIFT WIRE KIT	KIT CAVO CAMBIO	KIT CÂBLE CHANGEMENT	1
		REC805320A03	KIT SENSORES TRIM	SENSOR TRIM KIT	KIT SENSORI TRIM	KIT SONDES TRIM	1
		REC80W90U6	ACEITE SINTETICO 80W-90	SYNTHETIC OIL 80W-90	OLIO SINTETICO 80W-90	HUILE SYNTHÉTIQUE 80W-90	2

	REF					
ALPHA ONE (GENII) (1991+) (OD469259+)	REC27-94996Q2	KIT JUNTAS TRANSOM	TRANSOM GASKET KIT	KIT GUARNIZIONE TRANSOM	KIT JOINTS TRANSOM	1
	REC30-879194A01	RODAMIENTO TRANSOM	TRANSOM BEARING	CUSCINETTO TRANSOM	ROULEMENT TRANSOM	1
	REC816431A1	FUELLE TRANSMISION	TRASMISION BELLOW	CUFFIA TRASMISSIONE	SOUFFLET TRANSMISSION	1
	REC18654A1	FUELLE ESCAPE	EXHAUST BELLOW	CUFFIA DI SCARICO	SOUFFLET ECHAPPEMENT	1
	REC74639Q02	FUELLE CABLE CAMBIO	SHIFT WIRE BELLOW	CUFFIA CAVO CAMBIO	SOUFFLET CÂBLE CHANGEMENT	1
	REC10-79953Q04	TAPON DE NIVEL ACEITE	OIL LEVEL CAP	TAPPO LIVELLO OLIO	BOUCHON DE NIVEAU D'HUILE	1
	REC22-67892A05	TAPON DERENAJE ACEITE	OIL DRAIN CAP	TAPPO SCARICO OLIO	BOUCHON VIDANGE	1
	CM821629	ANODO PLACA	PLATE ANODE	ANODO PIASTRA	ANODE PLAQUE	1
	REC821631Q1AL	ANODO TRANSOM (MERCAT)	TRANSOM ANODE (MERCAT)	ANODO TRANSOM (MERCAT)	ANODE TRANSOM (MERCAT)	1
	REC76214Q5AL	ANODO TIMON (plano)	RUDDER ANODE (flat)	ANODO TIMONE (plano)	ANODE TIMON (plane)	1
	CM46399	ANODO TIMON (aleta)	RUDDER ANODE (flap)	ANODO TIMONE (flap)	ANODE TIMON (flap)	1
	REC806105Q1AL	ANODO HELICE (CARRIER)	PROPELLER ANODE (CARRIER)	ANODO ELICA (CARRIER)	ANODE HELICE (CARRIER)	1
	REC806189Q1AL	ANODO BRAZO TRIM	TRIM ARM ANODE	ANODO BRACCIO TRIM	ANODE ARM TRIM	2
	RECKITMALPHA2AL	KIT ANODOS	ANODE KIT	KIT ANODI	KIT ANODES	1
	REC32-4172533	TUBO AGUA TRANSOM	WATER TUBE TRANSOM	TUBO ACQUA TRANSOM	TUBE À EAU TRANSOM	1
	REC47-43026Q02	IMPULSOR	IMPELLER	GIRANTE	TURBINE	1
	REC817275Q05	KIT BOMBA DE AGUA	WATER PUMP KIT	KIT POMPA ACQUA	KIT POMPE À EAU	1
	REC865436A03	KIT CABLE CAMBIO	SHIFT WIRE KIT	KIT CAVO CAMBIO	KIT CÂBLE CHANGEMENT	1
	REC805320A03	KIT SENSORES TRIM	SENSOR TRIM KIT	KIT SENSORI TRIM	KIT SONDE TRIM	1
	REC80W90U6	ACEITE SINTETICO 80W-90	SYNTHETIC OIL 80W-90	OLIO SINTETICO 80W-90	HUILE SYNTHÉTIQUE 80W-90	2
	BRAVO I / II & III	REC16755Q1	KIT JUNTAS TRANSOM	TRANSOM GASKET KIT	KIT GUARNIZIONE TRANSOM	KIT JOINTS TRANSOM
REC30-879194A01		RODAMIENTO TRANSOM	TRANSOM BEARING	CUSCINETTO TRANSOM	ROULEMENT TRANSOM	1
REC86840A05		FUELLE TRANSMISION	TRASMISION BELLOW	CUFFIA TRASMISSIONE	SOUFFLET TRANSMISSION	1
REC18654A1		FUELLE ESCAPE	EXHAUST BELLOW	CUFFIA DI SCARICO	SOUFFLET ECHAPPEMENT	1
REC78458A1		FUELLE ESCAPE COLECTOR	EXHAUST BELLOW	CUFFIA SCARICO COLLETORE	SOUFFLET D'ECHAPPEMENT	1
REC74639Q02		FUELLE CABLE CAMBIO	SHIFT WIRE BELLOW	CUFFIA CAVO CAMBIO	SOUFFLET CÂBLE CHANGEMENT	1
REC22-67892A05		TAPON DE NIVEL ACEITE	OIL LEVEL CAP	TAPPO LIVELLO OLIO	BOUCHON DE NIVEAU D'HUILE	1
REC22-67892A05		TAPON DERENAJE ACEITE	OIL DRAIN CAP	TAPPO SCARICO OLIO	BOUCHON VIDANGE	1
CM821630		ANODO PLACA	PLATE ANODE	ANODO PIASTRA	ANODE PLAQUE	1
CM43994		ANODO TRANSOM (MERCAT)	TRANSOM ANODE (MERCAT)	ANODO TRANSOM (MERCAT)	ANODE TRANSOM (MERCAT)	1
CM76214Q5		ANODO TIMON (Plano con rosca)	RUDDER ANODE (flat with thread)	ANODO TIMONE (plano con filo)	ANODE TIMON (plane avec filet)	1
CM762144		ANODO TIMON (plano sin rosca)	RUDDER ANODE (flat without thread)	ANODO TIMONE (plano senza filo)	ANODE TIMON (plane sans filet)	1
CM806188		ANODO HELICE (CARRIER)	PROPELLER ANODE (CARRIER)	ANODO ELICA (CARRIER)	ANODE HELICE (CARRIER)	1
CM865182CZ		ANODO EJE HELICE (BRAVO III 2004+)	SHAFT PROPELLER ANODE (BRAVO III 2004+)	ANODO ASSE ELICA (BRAVO III 2004+)	ANODO ARBRE D'HELICE (BRAVO III 2004+)	1
CM806190		ANODO BRAZO TRIM	TRIM ARM ANODE	ANODO BRACCIO TRIM	ANODE ARM TRIM	2
REC55989Q9		ANODO BOLA TRANSOM	BALL ANODE TRANSOM	ANODO BOLLA TRANSOM	ANODE BALL TRANSOM	1
RECKITMBRAVO1AL		KIT ANODOS BRAVO I	ANODE KIT BRAVO I	KIT ANODI BRAVO I	KIT ANODES BRAVO I	1
RECKITMBRAVO23AL		KIT ANODOS BRAVO II	ANODE KIT BRAVO II	KIT ANODI BRAVO II	KIT ANODES BRAVO II	1
RECKITMBRAVO3AL		KIT ANODOS BRAVO III	ANODE KIT BRAVO III	KIT ANODI BRAVO III	KIT ANODES BRAVO III	1
REC32-43437		TUBO AGUA TRANSOM (BRAVO I)	WATER TUBE TRANSOM (BRAVO I)	TUBO ACQUA TRANSOM (BRAVO I)	TUAYU À EAU TRANSOM (BRAVO I)	1
REC815471T1		KIT CABLE CAMBIO	SHIFT WIRE KIT	KIT CAVO CAMBIO	KIT CÂBLE CHANGEMENT	1
REC805320A03	KIT SENSORES TRIM	SENSOR TRIM KIT	KIT SENSORI TRIM	KIT SONDES TRIM	1	
REC80W90U6	ACEITE SINTETICO 80W-90	SYNTHETIC OIL 80W-90	OLIO SINTETICO 80W-90	HUILE SYNTHÉTIQUE 80W-90	3	

MATERIALES GENÉRICOS PARA REVISION

GENERIC MATERIALS FOR REVISION

MATERIALE GENERICICO PER LA REVISIONE

MATÉRIAUX GÉNÉRIQUES POUR L'EXAMEN

REF				
GS90002	PINTURA NEGRA MERCUISER EN SPRAY	BLACK PAINT MERCUISER SPRAY	PITTURA NERA MERCUISER. SPRAY	PEINTURE EN SPRAY NOIRE
GS90012	SPRAY IMPRIMACION PARA MOTORES	SPRAY PRIMER FOR ENGINES	PRIMER PER MOTORI. SPRAY	PRIMER POUR MOTEUR
GS90019	BARNIZ TRANSPARENTE PROTECTOR PINTURA EN SPRAY	CLEAR VARNISH, SPRAY PAINT PROTECTOR	VERNICE TRASPARENTE, PROTETTORE DI PITTURA. SPRAY	VERNIS TRANSPARENT, PROTECTEUR EN SPRAY
GS90090	PROTECTOR OXIDO MOTOR EN SPRAY	SPRAY ENGINE PROTECTOR FROM RUST	PROTETTORE MOTORE DALL'OSSIDAZIONE. SPRAY	PROTECTEUR MOTEUR DE L'OXYDATION EN SPRAY
GS90092	PROTECTOR DIELECTRICO EN SPRAY	SPRAY DIELECTRIC PROTECTOR	PROTETTORE DIELETTICO. SPRAY	PROTECTEUR DIELECTRIQUE EN SPRAY
RECGREU1	BOTE GRASA MARINA 450 g	MARINE GREASE 450 g	GRASSO MARINO 450 g	GRAISSE MARINE 450g

SISTEMA DE ALIMENTACIÓN Y FILTRACIÓN FUEL & FILTRATION SYSTEM

SISTEMA DI ALIMENTAZIONE E FILTRAZIONE SYSTÈME D'ALIMENTATION ET DE FILTRATION



FILTRO DE COMBUSTIBLE Y ELEMENTOS

FUEL FILTERS AND ELEMENTS

FILTRI BENZINA E RACCORDI

FILTRE A ESSENCE ET CARTOUCHE DE RECHANGE

MOTORES GASOLINA

GAS ENGINE

MOTORI BENZINA

MOTEUR ESSENCE

BRACKET

BRACKET

SUPPORTO

TÊTE DE FILTRE À ESSENCE

Con 2 tapones de bronce y 2 tubos de extensión. (2 entradas y 2 salidas).

With 2 brass plugs and 2 extension tubes. (2 inputs & 2 outputs).

Con 2 tappi di bronzo e 2 tubi di estensione. (2 ingressi entrata carburante e 2 uscite carburante).

Avec 2 bouchons en bronze et 2 tubes d'extension. (2 entrées et 2 sorties).

REF		
REC25000	1/4"	AL
REC25010	1/4"	INOX /SS AISI316
REC25020	3/8"	AL
REC25030	3/8"	INOX /SS AISI316
RECOBBRACKET	1/4"	Plast.



REC25000 - REC25020



REC25010 - REC25030



RECOBBRACKET

RECMAR®

FILTRO COMBUSTIBLE SEPARADOR DE AGUA

WATER SEPARATING FUEL FILTER

FILTRO SEPARATORE ACQUA-BENZINA

FILTRE À ESSENCE

REF	MICRON	
REC24942	10	47/16" = 11 cm
REC35-802893Q01	10	3 3/4"
REC855686	28	4 7/16"
REC35-802893Q	25	3 3/4"
RACPF5510	10	4 7/16"

RACOR®

RECMAR®



RACPF5510



REC24942



REC35-802893Q01



REC855686



REC35-802893Q

REF	R.O./OEM		
RM35-866594Q01	35-866594Q01 35-866594K01	100VAZER, 100VAZER EC	3.0L MPI EC

RECMAR®



Filtro original.

OEM filter.

Filtro benzina originale.

Filtre à essence original

REF	MICRON	
RM35-802893Q	10	3 3/4"

QUICKSILVER



FILTRO CON BRACKET

Con 2 tapones de bronce y 1 tubo de extensión.

OEM FILTER WITH BRACKET

With 2 brass plugs & 1 extension tube.

FILTRO BENZINA CON SUPPORTO

Con 2 tappi di bronzo e 1 tubo di estensione.

FILTRE A ESSENCE AVEC SUPPORT

avec 2 bouchons en bronze et 1 tube d'extension

REF	MICRON			BRACKET
REC24950	25	1/4"		50 GPH AL
REC24952	10	1/4"		50 GPH AL

RECMAR®



**FILTRO DECANTADOR GASOLINA****COMPLETE FUEL FILTER****FILTRO DECANTATORE BENZINA****FILTRE DÉCANTEUR POUR ESSENCE****RACOR**

				RAC120R-RAC-01	RAC320R-RAC-01	RAC320R-INOX-01	RAC320R-RAC-02
FLUJO MÁXIMO	MAX. FLOW	FLUSSO MASSIMO	FLUX MASSIMALE	114 l/h 30 gph	340 l/h 60 gph	340 l/h 60 gph	340 l/h 60 gph
ELEMENTO	ELEMENT	ELEMENTO	ÉLÉMENT	RACS3240	RACS3213	RACS3213	RACS3220UL
CAZOLETA TRANSPARENTE (sólo se recomienda para fueraborda.)	CLEAR BOWL (just for outboards)	VASCHETTA TRASPARENTE (solo nei fuoribordo.)	CAZOLETA TRANSPARENTE (uniquement recommandé pour le hors-bord.)	✓ PLAST.	✓ PLAST.	✓ PLAST.	✗ METAL
ROSCAS CENTRALES	CENTRAL THREADS	FILETTO CENTRALE	FILS CENTRAUX	M18 x 1.5	1 1/4"	1 1/4"	1 1/4"
TAMAÑO ROSCA CABEZA	HEAD PORT SIZE	DIMENSIONE VITE TESTA	TAILLE DU FIL DE TÊTE	1/4-18 NPTF	1/4-18 NPTF	1/4-18 NPTF	1/4-18 NPTF
ALTURA X Ø	HEIGHT X Ø	ALTEZZA X Ø	HAUTEUR X Ø	166 x 81 mm	238 x 102 mm	238 x 102 mm	238 x 102 mm
PESO	WEIGHT	PESO	POIDS	0,5 kg	0,9 kg	0,9 kg	0,9 kg
CAIDA DE PRESIÓN	PRESSURE DROP	CADUTA DI PRESSIONE	CHUTE DE PRESSION	0.15 PSI 0.01 bar	0.61 PSI 0.04 bar	0.61 PSI 0.04 bar	0.61 PSI 0.04 bar
PRESIÓN MÁXIMA	MAX. PRESSURE	PRESIONE MASSIMA	PRESSION MAXIMALE	7 PSI 0.05 bar	7 PSI 0.05 bar	7 PSI 0.05 bar	7 PSI 0.05 bar
DESMONTAJE CARTUCHO-CAZOLETA	ELEMENT REMOVAL UNDERBOWL	RIMOZIONE DELLA CARTUCCIA	DÉMONTAGE DE LA CARTOUCHE	25,4 mm 1"	25,4 mm 1"	25,4 mm 1"	25,4 mm 1"
TEMPERATURA DE TRABAJO	OPERATING TEMPERATURE	TEMPERATURA DI LAVORO	TEMPERATURE DE TRAVAIL	-40°C +124°C			

ELEMENTOS DE RECAMBIO**ELEMENT****ELEMENTI DI RICAMBIO****CARTOUCHE DE RECHANGE**

REF	OEM	
RACS3240		RAC120R-RAC-01
LENS3240		
RACS3227	35-886638	
LENS3227		
RACS3213		RAC320R-RAC-01
LENS3213	35-809097	RAC320R-RAC-01 INOX RAC320R-RAC-03
RACS3214	35-809099	
RACS3228UL		RAC320R-RAC-02, bracket RACOR

LENS3240
LENS3227
LENS3214RACS3240
RACS3227
RACS3214

RACS3228UL

RÁCORES DE LATÓN

BRASS RACORS

RACCORDI IN OTTONE

RACCORDS À LAITON



REF	OEM			
GS31066	22-89771Q2	1/4" NPT	5/16" = 7.9 mm	2
GS31067		1/4" NPT	3/8" = 9.5 mm	2
REC22-866725		3/4" NPT		

GOLDENSHIP

RECMAR®



GS31066
GS31067



REC22-866725

REF			
GS31065	1/4" NPT	3/8" = 9.5 mm	1
GS31066	1/4" NPT	5/16" = 7.9 mm	2
GS31055	3/8" NPT	3/8" = 9.5 mm	2
GS31056	3/8" NPT	5/16" = 7.9 mm	2
GS31157	3/8" NPT	1/4" = 6.4 mm	2

GOLDENSHIP



FILTRO COMBUSTIBLE PARA MONTAJE EN LINEA

IN-LINE FUEL FILTER

FILTRO BENZINA PER MONTARE IN LINEA

FILTRE A ESSENCE EN LIGNE



REF				GOLDENSHIP
GS31001	50 l/h	6-8 mm	plast.	
GS31002	150 l/h	8-10 mm		



GS31001



GS31002

REF	OEM		
REC864572	864572 35-864572	3/8"	EFI & MPI, 8.1L & 496 CID (in-line) MPI & EFI (boost pump)

RECMAR®



REF	OEM	
REC1397-8767Q	GM 2.5L/3.0L (6229718+)	
	GM 5.0L/5.7L (6218462+)	
	205 (A331455+)	
	228 HP (6021784+)	
	330 HP (6083145+)	
	GM 255 (590768+)	
5.7L SKI 340, 230 & 260 inboards		



REF	OEM		
REC35-8M0122423	35-884380T		
RAC31871	35-8M0020349		
	35-8M0060041		
		MCM 4.5L (V6)	
		6.2L (V8)	



REF	OEM		
REC35-866171A01	35-866171A01	4 7/16"	5.0 - 350 - 6.2 & 8.1 MPI, MIE 496 MAG con módulo de bomba combustible with fuel pump module con modulo pompa combustibile avec module pompa d'essence



REF	OEM		
REC35-8M0046752	35-8M0046752 35-11004A1 35-803897Q1	4 7/16"	2.5L/3.0L (6229718+) MCM224 CID (6218037+) GM262 CID (A331455+) con carter de bomba combustible with carter fuel pump con carter pompa combustibile avec carter pompe d'essence





**FILTRO DE GASOLINA
CARBURADOR**

CARBURETOR FUEL FILTER

**FILTRO BENZINA
CARBURATORE**

**FILTRE À ESSENCE
CARBURATEUR**

REF	OEM	
REC35-53336	35-53336Q 35-53336 3302-9033	GM INLINE 4 & 6 cyl FORD & GM V8 400 HP+ MERCUISER 224 CID



REF	OEM	CARB.
REC93568	35-93568	ROCHESTER 2BBL & 4 BBL
REC35-49088A2	35-49088Q2 35-49088A2	4 & 6 CYL INLINE
REC1397-2150	1397-2150	ROCHESTER



REC93568



REC35-49088A2



REC1397-2150



FILTRO VST

VST FILTER

FILTRO VST

FILTRE VST

REF	OEM	
REC65L-13915-00	808504 8085041 808504T1	262 MAG (TBI) GEN+
		350 MPI, TBI, EFI (1994-96)
		454 EFI (GEN V) GM (1994-96)
		454 EFI (SKI GEN V) GM (1995)
		454 MAG BRAVO MPI (GEN VI) GM (1996-97)
		5.7 EFI (TBI) GM 350 V8 (1995)
		7.4L MIE MPI (LH) (GEN V) GM (1995-96)
		7.4L MIE MPI (LH) (GEN VI) GM (1996-97)
		7.4LX BRAVO MPI (GEN V) GM (1996)
		7.4LX BRAVO MPI (GEN VI) GM (1996-97)
8.2L MIE MPI (LH) (GEN VI) GM (1996-97)		



REF	OEM	
REC35-892665	35-892665	5.0 (350, 377, 383, 496) 6.2 & 8.1 MPI



FILTROS AIRE

AIR FILTER

FILTRI ARIA

FILTRE AIR

REF	OEM	
RM35-863829	35-863829	350 MAG
		383 MAG
		496 MAG
		357 HRZ
		4.3L MPI
		5.0L MPI
		6.2L MPI



REF	OEM	
RM35-8M2001030	35-8M2001030	350 MAG MPI
		377 MAG MPI
		4.3L MPI
		5.0L MPI
		5.7L MPI
		6.2L MPI



FILTRO DE ACEITE
OIL FILTER
FILTRO OLIO
FILTRE A HUILE

REF	OEM		
RM35-883702Q	35-883702Q	18 mm x 1.5	V6 GM MCM V-6 *
RM35-866340Q02	35-866340Q03	13/16" x 16 NPT	GM 4 inline, V8 MCM / MIE GM V-6 *

* sin filtro de aceite remoto
 * without oil remote filter
 * senza filtro dell'olio remoto
 * sans filtre à huile à distance

REF	OEM		
REC35-06004	35-883702Q	18 mm x 1.5	GM V6
REC35-06003	35-866340Q03	13/16" x 16 NPT	GM 4 inline, V8
REC35-06007	35-802886Q 60565 35-8M0116378	3/4" x 16 NPT	V8 Ford

REF	OEM		
REC3850559	35-16595Q	2006+ MCM HiPerformance GM V8	

new

FILTRO ACEITE PARA DIRECCION HIDRAULICA AXIUS
HYDRAULIC OIL FILTER FOR AXIUS POWER STEERING
FILTRO OLIO PER MOTORI CON STERZO IDRAULIC AXIUS
FILTRO D'HUILE POUR MOTEURS AVEC DIRECTION HYDRAULIQUE AXIUS

REF	OEM		
REC35-8M0138697	35-8M0138697 35-881132T	MCM AXIUS STEERING	

new



GUÍA ACEITE

OIL GUIDE

GUIDA OLIO

GUIDE D'HUILE

MOD.	BASE	 (l)	REF.
MCM 60	1965-68 Renault - L4	2,6	REC25W40U3
MCM 80	1966-69 Renault - L4	4,73	REC25W40U3
MCM 90	1970-72 Renault - L4	4,73	REC25W40U3
MCM 110/120/2.5L	1963-89 GM - L4	3,78	REC25W40U3
MCM140/3.0L/LX	1968+ GM - L4	3,78	REC25W40U3
MCM 470/165/170/3.7L	1976-89 Mercury - L4	5,2	REC25W40U3
MCM 485	1980-82 Mercury - L4	5,44	REC25W40U3
MCM 488/180/190/3.7LX	1983-89 Mercury - L4	6,15	REC25W40U3
MCM 140	1963 GM - L6	4,73	REC25W40U3
MCM 160/165	1967-81 GM - L6	4,73	REC25W40U3
MCM 200	1969 GM - L6	5,68	REC25W40U3
MCM 185 (4bb)	1983-84 GM - V6	4,26	REC25W40U3
MCM 175/185/205	1985-87 GM - V6	4,26	REC25W40U3
MCM262 Mag EFI	1996-97 GM - V6	4,26	REC25W40U3
MCM 4.3L/LX/LH/LIIX & 262 Mag	1988-01 GM - V6	4,26	REC25W40U3
MCM 4.3L EFI	1998-01 GM - V6	4,26	REC25W40U3
MCM 4.3L & MPI	2002+ GM - V6	3,78	REC25W40U3
MCM 888	1971-77 Ford - V8	5,68	REC25W40U3
MCM/M1E 225	1973-74 Ford - V8	5,68	REC25W40U3
MCM/MTE 215	1970-72 Ford - V8	6,62	REC25W40U3
MCM 190	1963-64 GM - V8	4,73	REC25W40U3
MCM 898/200/5.0L	1977-95 GM - V8	4,73	REC25W40U3
MCM 228	1977-78 GM - V8	4,73	REC25W40U3
MCM 228/ 230/5.0LX	1979-95 GM - V8	5,2	REC25W40U3
MIE 198/228/230/5.0L	1977-88 GM - V8	5,68	REC25W40U3
MCM 5.0L & EFI	1998-02 GM - V8	5,2	REC25W40U3
MCM 5.0L & MPI	2002-up GM - V8	4,26	REC25W40U3
MCM 225	1963-66 GM - V8	4,73	REC25W40U3
MCM 225/250	1967-69 GM - V8	6,62	REC25W40U3
MIE 225/250	1968 GM - V8	5,68	REC25W40U3
MCM 250/255	1975-77 GM - V8	4,73	REC25W40U3
MCM 260/5.7L/LX & EFI	1978-02 GM - V8	5,2	REC25W40U3
MCM 350 MAG, EFI, & MPI	1986-02 GM - V8	5,2	REC25W40U3
MCM 350 MAG & MPI	2002+ GM - V8	4,26	REC25W40U3
MCM 5.7L	2002+ GM - V8	4,26	REC25W40U3
MIE 255/260/5.7L	1975-93 GM - V8	5,68	REC25W40U3
MIE 5.7L & EFI	1993-97 GM - V8	3,78	REC25W40U3
MIE 5.7L/ 350 Mag MPI	1998-02 GM - V8	5,2	REC25W40U3

MOD.	BASE	 (l)	REF.
MIE 5.7L/ 350 Mag MPI	2002+ GM - V-8	4,26	REC25W40U3
MIE Ski 5.7L	1985-89 GM - V-8	3,78	REC25W40U3
MIE Ski 5.7L/350 Mag & MPI	1990-97 GM - V-8	4,73	REC25W40U3
MIE Ski 5.7L/350 Mag & MPI	1998-02 GM - V-8	5,2	REC25W40U3
MIE Ski 5.7L/350 Mag & MPI	2002+ GM - V-8	4,26	REC25W40U3
Black Scorpion Ski (Gen+)	1996-97 GM - V-8	4,73	REC25W40U3
Black Scorpion Ski (Gen+)	1998-01 GM - V-8	5,2	REC25W40U3
Black Scorpion Ski (Gen+)	2003+ GM - V-8	4,26	REC25W40U3
MX 6.2L MPI	2000-02 GM/Mercury - V-8	5,2	REC25W40U3
MX 6.2L MPI	2002+ GM/Mercury - V-8	4,26	REC25W40U3
MX 6.2L MPI MIE	1999-02 GM/Mercury - V-8	5,2	REC25W40U3
MX 6.2L MPI MIE & Ski	2002+ GM/Mercury - V-8	4,26	REC25W40U3
MX 6.2L Bik Scorpion Ski	2001-03 GM/Mercury - V-8	5,2	REC25W40U3
MX 6.2L Bik Scorpion Ski	2003+ GM/Mercury - V-8	4,26	REC25W40U3
MCM 233/255	1973-77 Ford - V-8	4,73	REC25W40U3
MIE 233/255 - V-Drive	1973-76 Ford - V-8	6,62	REC25W40U3
MCM 325	1969-72 GM - V8	7,57	REC25W40U3
MIE 325	1968-74 GM - V8	6,62	REC25W40U3
MCM 330	1977-81 GM - V8	5,68	REC25W40U3
MCM 330 & 454 Mag Alpha	1982-88 GM - V8	6,62	REC25W40U3
MCM 7.4L & 454 Mag	1988-91 GM - V8	7,57	REC25W40U3
MCM 7.4L/LX & 454 Mag, EFI & MPI	1992-01 GM - V8	6,62	REC25W40U3
MIE 330	1977-80 GM - V8	6,62	REC25W40U3
MIE 340/7.4 w/Borg Warner trans.	1981-92 GM - V8	6,62	REC25W40U3
MIE 7.4L w/Hurth trans.	1988-92 GM - V8	7,57	REC25W40U3
MIE 7.4L & 454 Mag MPI	1992-01 GM - V8	6,62	REC25W40U3
MIE Ski 454 Mag EFI & MPI	1995-97 GM - V8	6,62	REC25W40U3
MCM 390	1969-70 GM - V8	7,57	REC25W40U3
MIE 390	1969-70 GM - V8	6,62	REC25W40U3
MCM 496 Mag & HO	2001+ GM - V8	8,51	REC25W40U3
MIE 8.1 S Horizon & HO	2001+ GM - V8	8,51	REC25W40U3
MCM 502 Mag	1990-92 GM - V8	7,57	REC25W40U3
MCM 502 Mag, EFI & MPI	1992-01 GM - V8	6,62	REC25W40U3
MIE 8.2L	1990-96 GM - V8	7,57	REC25W40U3
MIE 8.2L	1996-06 GM - V8	6,62	REC25W40U3

FILTRO DE COMBUSTIBLE Y ELEMENTOS

FUEL FILTERS AND ELEMENTS

FILTRI BENZINA E RACCORDI

FILTRE A ESSENCE ET CARTOUCHE DE RECHANGE

MOTORES DIESEL

DIESEL ENGINE

MOTORI DIESEL

MOTEUR DIESEL



REF	OEM	
REC882376	882376	1.7DTI Original MS120

REF	OEM	
REC35-808275	35-808275	D7.3/270 Bravo Et MIE Diesel (1994-96)

REF	OEM	
REC35-19486	35-19486 35-8M0103963	D254 D3.0L D3.6L D4.2L

REF	OEM	
REC35-807256	35-807256T	D3.0L D3.6L D7.3L D-Tronic CMD 2.8 CMD 4.2 D2.8L

REF	OEM	
REC35-8M0067337	35-8M0067337	MCM/MIE 1.9L, 2.5L, 3.0L V6 AMD V8 TDI

new

REF	OEM	
REC35-879172104	35-879172104	(MQSD MODELS) 2.0L, 2.8L, 4.2L base VM

REF	OEM	MICRON	
REC35-8M6002390	35-8M6002390	2	MCM/MIE 4.2L V8 TDI 335 Et 370 (CMC000200+)

new



FILTRO CON CAZOLETA

BOWL FILTERS

FILTRO CON COPPA

FILTRE AVEC COUPE



RACOR

	RAC500MA30	RAC900VMA	RAC900MA30	RAC1000VMA	RAC1000MA30	RAC75/500MAX	RAC75/1000MA30
	227 l/h 60 gph	340 l/h 90 gph	341 l/h 90 gph	681 l/h 180 gph	681 l/h 180 gph	454 l/h 120 gph	681 / 1363 l/h 180 / 360 gph
	2010	2010	2040	2010	2020	2010	2020
A X B X C	292 x 147 x 122 mm	432 x 220 x 200 mm	432 x 152 x 178 mm	557 x 220 x 200 mm	559 x 152 x 178 mm	292 x 368 x 241 mm	559 x 476 x 279 mm
	3/4"-16 UNF	7/8"-14 UNF	7/8"-14 UNF	7/8"-14 UNF	7/8"-14 UNF	3/4"-16 UNF	7/8"-14 UNF
	2 kg	4,9 kg	3 kg	5,6 kg	5 kg	7,7 kg	13,6 kg
CAIDA DE PRESIÓN PRESSURE DROP CADUTA DI PRESSIONE CHUTE DE PRESSION	0.61 PSI 0.04 bar	0.30 PSI 0.021 bar	0.34 PSI 0.02 bar	0.43 PSI 0.03 bar	0.49 PSI 0.03 bar	0.70 PSI 0.05 bar	3.70 PSI 0.25 bar
MAX	15 PSI 1 bar	15 PSI 1 bar	15 PSI 1 bar	15 PSI 1 bar	15 PSI 1 bar	15 PSI 1 bar	15 PSI 1 bar
MÀX.	102 mm	127 mm	127 mm	254 mm	254 mm	102 mm	254 mm

ELEMENTOS DE RECAMBIO

ELEMENTS

ELEMENTI DI RICAMBIO

CARTOUCHE DE RECHANGE

500	900	1000	MICRON
RAC2010SM-OR	RAC2040SM-OR	RAC2020SM-OR	2
RAC2010TM-OR	RAC2040TM-OR	RAC2020TM-OR	10
RAC2010PM-OR	RAC2040PM-OR	RAC2020PM-OR	30

RACOR



S: SECUNDARIO
T: PRIMARIO O SECUNDARIO/FINAL
P: PRIMARIO

S: SECONDARY FINAL
T: PRIMARY OR SECONDARY FINAL
P: PRIMARY

S: SECONDARIO
T: PRIMARIO O SECONDARIO
P: PRIMARIO

S: SECONDAIRE
T: PRIMAIRE OU SECONDAIRE
P: PRIMAIRE

REF	OEM		MICRON
REC3581760	3581760	R500MA	30
REC889419	889419	R900MA	
REC889422	889422	R1000MA	

RECMAR



REC3581760

REC889419

REC889422

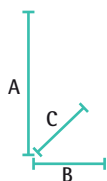

RACOR.



				RAC120AS	RAC230R2	RAC245R2	RAC460R2	RAC490R2
FLUJO MÁXIMO	MAX. FLOW	FLUSSO MASSIMO	FLUX MAXIMUM	57 l/h 15 gph	114 l/h 30 gph	170 l/h 45 gph	227 l/h 60 gph	341 l/h 90 gph
ELEMENTO	ELEMENT	ELEMENTO	ÉLÉMENT	RACR12	RACR20	RACR25	RACR60	RACR90
DIESEL				✓	✓	✓	✓	✓
GAS				✓				
CAZOLETA TRANSPARENTE	CLEAR BOWL	VASCHETTA TRASPARENTE	BOL TRASPARENT	✓	✓	✓	✓	✓
INSTALACIÓN VACUÓMETRO	VACUUM INSTALLATION	INSTALLAZIONE VACUOMETRO	INSTALLATION VACUOMETRE	✓	✓	✓	✓	✓
INSTALACIÓN PRESIÓN	PRESSURE INSTALLATION	INSTALLAZIONE PRESSIONE	INSTALLATION PRESSION	✓	✓	✓	✓	✓
A X B X C (mm)				165 x 81 x 81	229 x 102 x 102	267 x 102 x 102	279 x 114 x 121	300 x 114 x 121
PESO	WEIGHT	PESO	POIDS	0,59 kg	0,90 kg	1 kg	1,3 kg	1,4 kg
CAIDA DE PRESIÓN	PRESSURE DROP	CADUTA DI PRESSIONE	CHUTE DE PRESSION	0.15 PSI 0.01 bar	0.31 PSI 0.02 bar	0.61 PSI 0.04 bar	0.39 PSI 0.03 bar	0.95 PSI 0.06 bar
PRESIÓN MÁXIMA	MAX. PRESSURE	PRESSIONE MASSIMA	PRESSION MAXIMALE	7 PSI	30 PSI	30 PSI	30 PSI	30 PSI
ENTRADA	IN	ENTRATA	ENTRÉE	1/4" NPT	1/4" NPT	1/4" NPT	3/8" NPT	3/8" NPT
BOMBA CEBADO (SÓLO PARA DIESEL)	PRIMER PUMP (ONLY DIESEL)	POMPA (SOLO PER DIESEL)	POMPE (SEULEMENT POUR DIESEL)	✗	✓	✓	✓	✓
Nº TOMAS	NUM. OF PORTS	Nº FORI	Nº D'ENTREE / SORTIE	4	3	3	4	4
TIPO DRENAJE	DRAIN TYPE	TIPO DRENAGGIO	TYPE DE DRAINAGE	Sello positivo Positive seal Tenuta positiva Joint positif				
OPCIÓN SENSOR AGUA	WATER SENSOR OPTION	OPZIONE SENSORE ACQUA	OPTION SONDE DE PRESENCE D'EAU	✓	✓	✓	✓	✓

REF	MICROM
RACR11T	10



REF	MICROM
RACR24S	2
RACR24T	10
RACR24P	30



REF	MICROM
RACR60S	2
RACR60T	10
RACR60P	30



REF	MICROM
RACR12S	2
RACR12T	10
RACR12P	30



REF	MICROM
RACR25S	2
RACR25T	10
RACR25P	30



REF	MICROM
RACR90S	2
RACR90T	10
RACR90P	30



REF	MICROM
RACR20S	2
RACR20T	10
RACR20P	30



REF	MICROM
RACR26S	2
RACR26T	10
RACR26P	30



REF	MICROM
RACR120SM	2
RACR120TM	10
RACR120P	30





REF		
REC1140639	REC3581078	50 l/h

RECmar®

REF		
REC120	RACR12	15 l/h

RECmar®



new

REF		MICROM		
REC1766160	REC160ELEMENT	10	205-420 L/H (2.45PSI)	2 x 11/16" 10 mm

new

REF	OEM			
REC500MA	35-850481 35-850481A1	REC3581760	13 mm 10 mm	227 l/h

new

REF			
REC296TWIN	REC3581078	50 L/H	GS30432 (8mm) GS30433 (10 mm)

new

REF				CUBETA BOWL VASCHETTA SEAU METAL.
REC2656613	REC3581078	50 l/h	GS30432 (8mm) GS30433 (10 mm)	

new

REF			
RECSWK-2000/10	RECGS01030	600 L/H	2 x 2 x M22X1.5

new

REF			
RECSWK-2000/5	RECGS00530	300 L/H	2 x 2 x M16 X 1.5

FILTROS TIPO SEPAR 2000 FILTER TYPE SEPAR 2000 FILTRI DI TIPO SEPAR 2000 CARTOUCHE DE RECHANGE



REF	OEM	MICROM				
			(l/h)	(mm)	(mm)	(mm)
RECGS00530		10	300	75	24	75
RECGS01030	35-8M0067597	30	600	88	55	88
RECGS01830		30	1080	136	55	138

RECMAR®

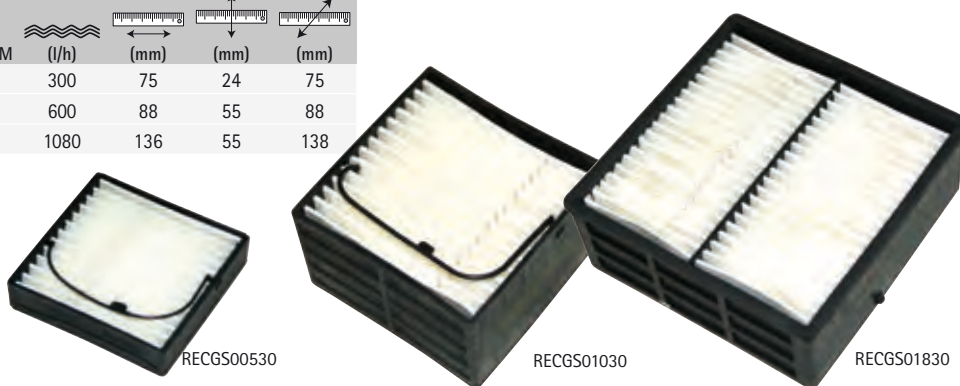

FILTROS AIRE

AIR FILTER

FILTRI ARIA

FILTRE AIR



REF	OEM	
REC35-8M6002131	35-8M6002131	3.0L TDI 100/230/260 V6

new

REF	OEM	
REC35-879172143	35-879172143	CMD QSD 2.0 115/130/150/170

new

REF	OEM	
REC35-898272048	35-898272048	CMD QSD 4.2 270/320/350

new

REF	OEM	
REC879172	879172 896332162	CUMMINS CMD 2.8 ES, EFI

new

REF	OEM	
REC35-19487	35-19487	530D 636D D183 D219 D254 D7.3L

REF	OEM	
REC35-805312	35-805312	D2.8L D254 D4.2L CMD MODELS



FILTRO TRANSMISION HURTH

FILTRO TRANSMISION HURTH

FILTRO TRASMISSIONE HURTH

FILTRE TRANSMISSION HURT

REF	OEM	
REC016940	879194241 35-815419	Mercruiser V8 Hurth Transmission 8.1L & 8.2L Inboard ZEUS 3000

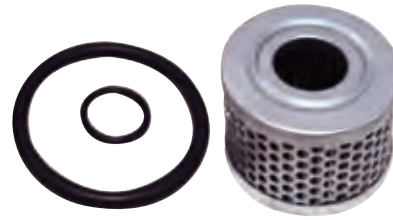

FILTRO DE ACEITE

OIL FILTER

FILTRO OLIO

FILTRE A HUILE

new





REF	OEM		Ø
REC35-879312041	35-879312041	(2008+) QSD 2.0 MCM ES 30 (88206399+) MCM ES 150 (88221799+) MCM ES 170 (88231000+) MIE EI 115 (88200499+) MIE EI 130 (88205099+) MIE EI 150 (88220299+) ME EI 170 (88230000+)	67 mm

new

REF	OEM	
REC35-8M0066483	35-8M0066483	3.0L V6 4.2L V8 TDI



REF	OEM		
REC3517857	35-803470 35-80470Q	3/4" x 16 NPT	60 & 80 HP (RENAULT)

Filtro corto
Short filter
Filtro corto
Filtre court



REF	OEM		
REC3850559	35-16595T1 35-16595Q 35-52731	13/16" x 16 NPT	230 CID, 250 CID 198 GM, 228 GM, 150 GM 330, 350, 370, 400, 420, 440, 460, 898

Filtro largo
Long filter
Filtro lungo
Filtre large



REF	OEM	
REC127695-35150	35-19485	530D, 636D D2.8L, D3.0L, D3.6L, D4.2L Motores VM engines



REF	OEM	
REC35-805809	35-805809 35-805809T	D7.3L





REF	OEM	
REC35-816168	35-816168	D254, D3.0L, D3.6L, D4.2L



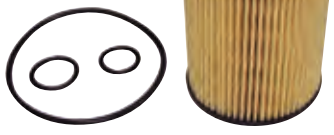

REF	OEM	
REC882687	882687 35-8M0150917	1.7DTS 120 diesel



REF	OEM	Ø	
REC895207	895207	3.25" (83 mm)	CUMMINS 2,8L CMD, QSD 2.0 / 2.8 / 4.2





GUÍA ACEITE		OIL GUIDE		GUIDA OLIO		GUIDE D'HUILE		
MOD.				REF.	MOD.			REF.
D1.7L DTI (Alpha)	2001+	1.7L	4,49	REC15W40U3	D254 Turbo AC (Bravo Et MIE)	1990-93	4.2L	12,06 REC15W40U3
D2.8L D-Tronic (Bravo Et MIE)	1997+	2.8L	8,04	REC15W40U3	D4.2L (Bravo Et MIE)	1994-97	4.2L	12,06 REC15W40U3
D183 Turbo AC (Bravo Et MIE)	1990-93	3.0L	8,99	REC15W40U3	D4.2L D-Tronic (Bravo Et MIE)	1997+	4.2L	12,06 REC15W40U3
530 D-TA (Bravo Et MIE)	1989-93	3.0L	8,99	REC15W40U3	D4.2L LD	1999+	4.2L	12,06 REC15W40U3
D3.0L (Bravo Et MIE)	1994-97	3.0L	8,99	REC15W40U3	7.3L (Bravo Et MIE)	1994-96	7.3L	11,35 REC15W40U3
D219 Turbo AC (Bravo Et MIE)	1990-93	3.6L	9,93	REC15W40U3	D7.3L D-Tronic	1996-01	7.3L	15,61 REC15W40U3
636 D-TA (Bravo Et MIE)	1989-93	3.6L	9,93	REC15W40U3				
D3.6L (Bravo Et MIE)	1994-97	3.6L	9,93	REC15W40U3				
D3.6L W (Bravo (MCM)(Intl.))	1997	3.6L	9,93	REC15W40U3				



RACORS		RACORS		RACCORDI		RACCORDS		
REF					ORIENTABLES	GUIDEBLE	ORIENTABILE	ORIENTABLE
GS30430	8 mm	2			REF			
GS30431	10 mm	2			GS30432	8 mm	2	





GOLDENSHIP



REF		
REC500MACON	500	3/8" = 10 mm







new

REF					
RAC1/2X16	1/2"	16 mm			1
RAC1/2X18	1/2"	18 mm			1
RAC1/2X20	1/2"	20 mm	500		1
RAC3/8X10	3/8"	10 mm	900		1
RAC3/8X12	3/8"	12 mm	1000		1
RAC3/8X14	3/8"	14 mm			1

RACOR



REF					
RAC1/2F-1/2M	7/8"	1/2"	900		1
RAC3/8F-3/8M	3/4"	3/8"	500		1



REF				
BRA125-3/16x1/4	1/4"	3/16"		1
BRA125-1/4x1/2	1/2"	1/4"		1
BRA125-5/16x3/8	3/8"	5/16"		1
BRA125-3/8x3/8	3/8"	3/8"		1
BRA125-3/8x1/2	1/2"	3/8"		1
BRA125-1/2x3/8	3/8"	1/2"		1
BRA125-1/2x1/2	1/2"	1/2"		1
BRA125-1/2x3/4	3/4"	1/2"		1
BRA125-5/8x3/8	3/8"	5/8"		1
BRA125-5/8x3/4	3/4"	5/8"		1
BRA125-3/4x3/4	3/4"	3/4"		1
BRA125-1x3/4	3/4"	1"		1



ACCESORIOS PARA FILTROS

FILTER ACCESSORIES

ACCESSORI PER FILTRI

ACCESSOIRES POUR FILTRES

LLAVES PARA FILTRO

FILTER KEY

CHIAVE DA FILTRO

CLÉ À FILTRE

REF
RACRK22628

RACOR



REF	
RECR70720	65 - 110 mm

RECMAR

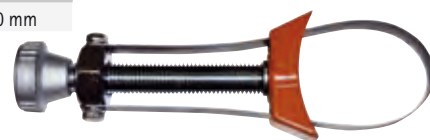

VÁLVULA DRENAJE AGUA DE FILTROS RACOR

DRAIN VALVE FOR RACOR FILTERS

VALVOLA DRENAGGIO ACQUA PER FILTRI RACOR

VANNE DE DRAINAGE D'EAU POUR FILTRE RACOR

REF
RACRK19492UL

RACOR



SENSOR DE AGUA PARA FILTROS DIESEL

WATER SENSOR FOR DIESEL FILTERS

SENSORE ACQUA PER FILTRI DIESEL

SONDE DE PRESENCE D'EAU POUR DIESEL

REF
RECRK21069

RECMAR



RELOJ SENSOR DE AGUA

WATER ALARM

ALLARME SENSORE ACQUA

ALARME SENSOR D'EAU

REF
RACRK20726

RACOR



BOMBA DE COMBUSTIBLE

FUEL PUMP

POMPA COMBUSTIBILE

POMPE À CARBURANT

BOMBA DE COMBUSTIBLE MECÁNICA

FUEL PUMP MECHANICAL

POMPA COMBUSTIBILE MECCANICA

POMPE À CARBURANT MECANIQUE

REF	OEM	Icon	Icon	Icon
REC862077A1	41141A2 862077A1	V6	REC35-8M0046752	REC27-34213

REF	OEM	Icon
REC86246T	86246T 86246 86246A1 78485 71646	V8

REF	OEM	Icon
REC86247T	62092T 62092 54552	Ford V8 302

REF	OEM	Icon
REC86247T	86247T 86247 86247A2 78820 63196 46860	V8 454 330, 325, 350, 390

REF	OEM	Icon
REC862048A1	812454A1 812454A3 97399A2 862048A1 97399	V8 305, 350, 454, 330, 420 Inline (4 cyl) 120, 140, 3.0L & 224 CID

REF	OEM	Icon	Icon
REC86234A4	86234A4 8623405 86234A3 86234 77594 71327 47585	GM (4 & 6 cyl)	REC35-49088A2

REF	OEM	Icon
REC861677T	861677T 818383T	GM V8 (454 & 502)

MOD.	SERIAL	REF
370 TRS-GM	A635178+	REC8M0058164
390-GM	D505450+	REC8M0058164
420-GM	6721528	REC862048A1
425-GM	2781129 - 2825059	REC86247T
454 GM (MAGNUM)	A398941+	REC862048A1
454 MAG. BRAVO GM	A398941+	REC862048A1
470	A631894 +	REC862048A1
470	B840126+	REC862048A1
470	-5097479	REC86234A4
470	5097480	REC86234A4
485	5520115 - 6218036	REC86234A4
488	6218037	REC86234A4

MOD.	SERIAL	REF
888 FORD	5685394	REC86234A4
898/198-GM	6170297	REC86234A4
898 GM	3108723	REC62092T
5.7 GM (SKI)	4762210 - 6218461	REC86246T
5.7 GM (SKI)	6218462	REC8M0058164
5.7L BRAVO (GM)350	A338553+	REC8M0058164
7.4L BRAVO GM	B514627+	REC8M0058164
7.4L W/HURTH (IB)	B525982+	REC8M0058164
7.4 BRAVO (GEN V)	B771113+	REC862048A1
7.4 BRAVO (GEN VI)	C391564+	REC862048A1
454 MAG BRAVO MPI (GEN VI) 1996-97		REC861677T

**BOMBA DE COMBUSTIBLE
ALTA PRESIÓN**

**HIGH PRESSURE FUEL
PUMP**

**POMPA COMBUSTIBILE
ALTA PRESSIONE**

**POMPE À CARBURANT
HAUTE PRESSION**

REF	OEM	
REC861156A1	861156A1	<p>350 Mag M.P.I. Alpha/Bravo/Horizon/MIE/Ski 4.3L EFI/Gen+ TBI/M.P.I. Alpha/Bravo-454 Mag M.P.I. Bravo Et Horizon 5.0/5.7L EFI/M.P.I. Alpha/Bravo-502 Mag M.P.I. 7.4L M.P.I. Bravo Et MIE 8.1L/8.2L MIE M.P.I. MX6.2L M.P.I. Alpha/Bravo/Horizon Et MIE Black Scorpion Scorpion 377 Stendrive Racing</p> <p>(Sin rosca) Reemplaza la bomba de combustible fría (Non threaded) Replaces cool fuel pump (Non filettato) Sostituisce la pompa del carburante fresco (Non fileté) Remplacement de la pompe à carburant froid</p>



REF	OEM	
REC827682T	827682T 827682	<p>262 MAG (TBI) (GEN+) 350 MAG EFI SKY (TBI) GM350 V-8 1994-1996 350MAG MPI SKY GM350 V-8 1995-1996 350 MAG ALPHA EFI (GEN+) GM350 V-8 1996 350 MAG BRAVO MPI GM350 V-8 1995 350 MAG BRAVO MPI (GEN+) GM350 V-8 1996 5.7L ALPHA EFI (TBI) GM350 V-8 1995 5.7L BRAVO (TBI) GM350 V-8 1995 5.7L EFI (2BBL-TBI) GM350 V-8 1996 5.7LX BRAVO EFI (GEN+) GM350 V-8 1996 5.7LX EFI (4BBL-TBI) GM350 V-8 1996</p> <p>OF803800 - OK999999 OF215561 - OF820706 OF350583 - OF799999 OF800300 - OK001508 OF415189 - OF601999 OF602000 - OK001500 OF355305 - OF752389 OF225560 - OF752399 OF752400 - OK001505 OF800300 - OK001508 OF752400 - OK001505</p>



REF	OEM	
REC8M0062770	8M0062770	<p>4.5L MPI (2A456613+) 6.2L MPI (2A449153+)</p>

new

REF	OEM	
REC866169T01	866169T01 305, 350, 377, 496 866169A01 5.0, 5.7, 6.2, 8.1, 8.2, 6.2L	<p>GM V-8 con módulo de alta presión Gen III. GM V-8 with Gen III cool fuel module high pressure. GM V-8 con modulo di alta pressione Gen III. GM V-8 avec module haute pression Gen III.</p>

**BOMBA DE COMBUSTIBLE
BAJA PRESION**

**LOW PRESSURE FUEL
PUMP**

**POMPA COMBUSTIBILE
BASSA PRESSIONE**

**POMPE À CARBURANT
BASE PRESSION**

REF	OEM	
CARP74021	12 Volt. 4-6PSI /20-30 GPH	

Poseen todas las medidas de seguridad exigidas. Puede usarse para trasvase de gasoil.

Listed by Marine Division UL. Used for diesel fuel transfer
Conforme con tutte le misure di sicurezza necessarie. Si può utilizzare per travasi di gasolio.

Ils disposent de toutes les mesures de sécurité requises. Peut être utilisé pour le transfert de carburant diesel.



REF	OEM
RECEFP-KT	



REF	OEM		
REC3858261	805656A2	V6 - V8 (Modelo antiguo Old Model Modello vecchio Ancien modèle)	8 PSI 25gpm
	805025A2		
	861155A5	4.3Fi Et Carburated 1992-93 (Bomba en línea Inline pump model Pompa in linea Bomba en línea)	
	805656A6		
	861155A6		



REF	OEM		
REC8M0103289	8M0062771	4.5L MPI (2A456613+) 6.2L MPI (2A449153+)	new



REF	OEM		
REC861155A6	861155A6	4.3L V-6	Sustituye modelos antiguos. Replaces old models. Sostituzione vecchi modelli. Remplace les anciens modèles.
	861155A5		
	805656A6		
	805656A2		
	805656A5		
	805025A2		



REF	OEM	
REC866170A01	866170A01	305, 350, 377 Et 496 CID

GM V-8 con módulo de baja presión Gen III.
GM V-8 with Gen III cool fuel module low pressure.
GM V-8 con modulo di bassa pressione Gen III.
GM V-8 avec module basse pression Gen III.



REF	OEM	
REC861155A3	861155A3 861155A2	4.3, 5.0 / 5.7, 8.1L V6 Et V8



MÓDULO DE COMBUSTIBLE COMPLETO

COMPLETE FUEL MODULE

MODULO CARBURANTE COMPLETO

MODULE DE CARBURANT COMPLET

REF	OEM	
REC8M0047215	8M0047215 864650A13 864650A05	5.7, 6.2, 8.1, 5.0, 8.2 496,350,377,520,540



new

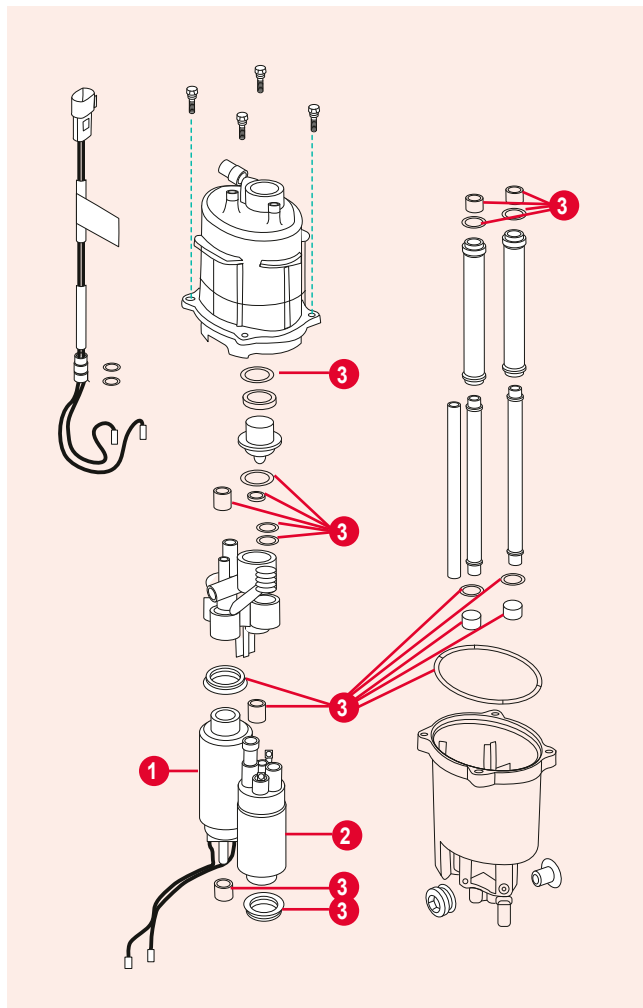
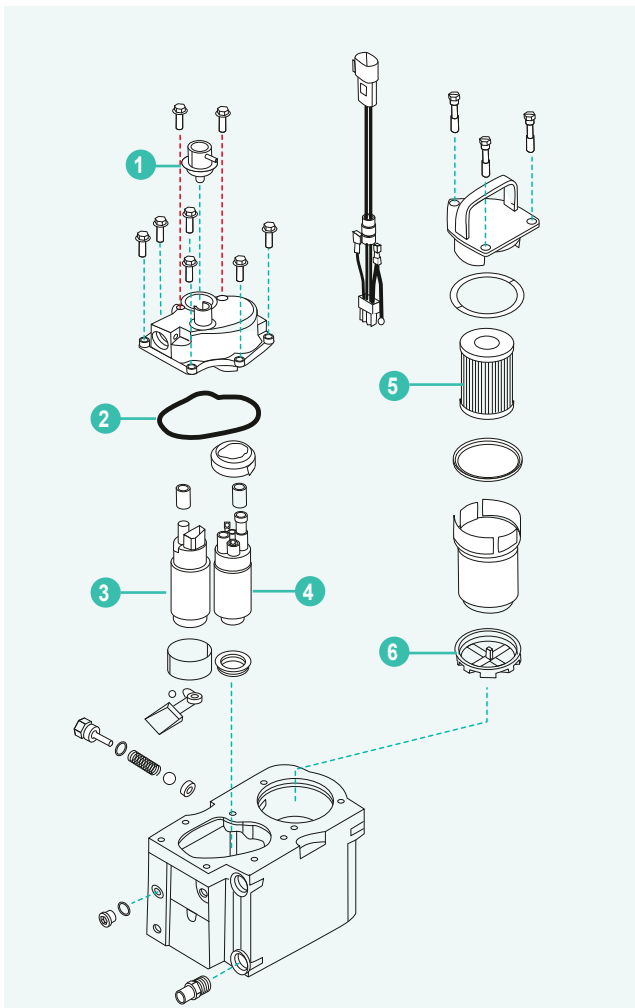

	REF	OEM				
1	REC892681	892681	REGULADOR	REGULATOR	REGOLATORE	REGULATEUR
2	REC26-892683	892683	JUNTA VST	VST GASKET	GUARNIZIONE VST	JOINT VST
3	REC866169T01	866169Y01	BOMBA DE ALTA PRESIÓN	PUMP, HIGH PRESSURE	POMPA ALTA PRESSIONE	POMPE HAUTE PRESSION
4	REC866170A01	866170A01	BOMBA BAJA PRESIÓN	PUMP, LOW PRESSURE	POMPA BASSA PRESSIONE	POMPE BASE PRESSION
5	REC35-866171A01	866171A01	FILTRO	FILTER	FILTRO	FILTRE
6	REC35-892665	892665	FILTRO GASOLINA	FUEL FILTER	FILTRO BENZINA	FILTRE À ESSENCE

	REF	OEM				
1	REC8M0062770	8M0062770	BOMBA DE ALTA PRESIÓN	PUMP, HIGH PRESSURE	POMPA ALTA PRESSIONE	POMPE HAUTE PRESSION
2	REC8M0103289	8M0062771	BOMBA BAJA PRESIÓN	PUMP, LOW PRESSURE	POMPA BASSA PRESSIONE	POMPE BASE PRESSION
3	REC8M0133370		KIT JUNTAS VST	GASKET VST, KIT	KIT GUARNIZIONE VST	KIT JOINTS VST

BOMBA DE COMBUSTIBLE Y KIT ENFRIADOR

ELECTRIC FUEL PUMP & COOLER

POMPA BENZINA E KIT SCAMBIATORE

POMPE À CARBURANT ET KIT REFROIDISSEUR

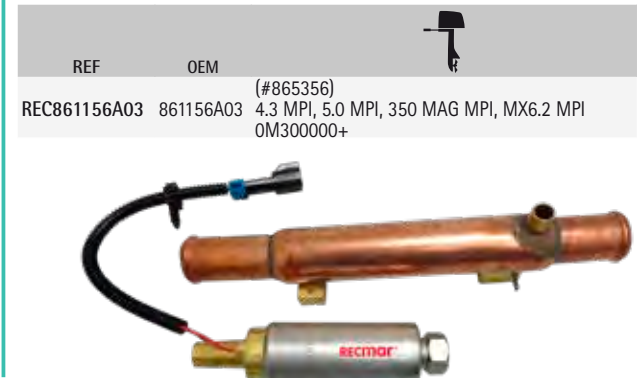

JUNTAS VST

VST GASKETS

GUARNIZIONE VST

JOINTS VST

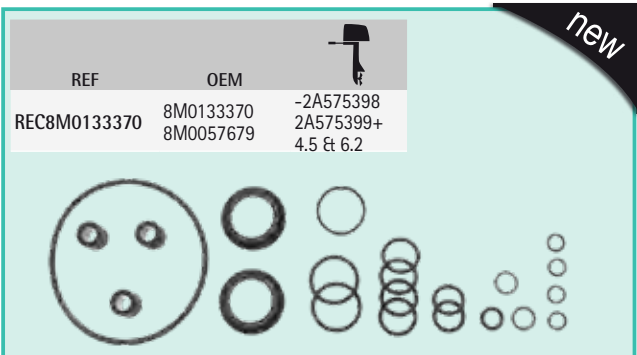
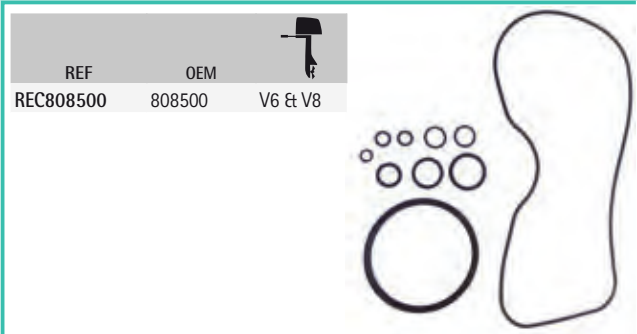
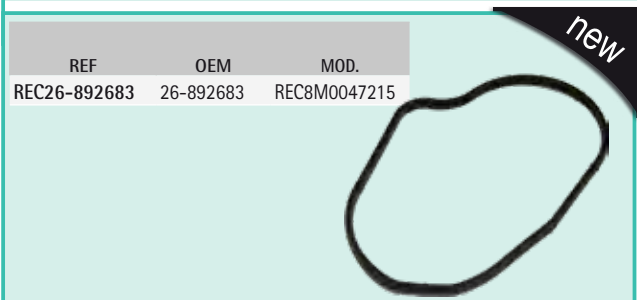

REGULADOR PRESIÓN DE COMBUSTIBLE

FUEL PRESSURE REGULATOR

REGOLATORI PRESSIONE CARBURANTE

REGULATEUR DE PRESSION DE CARBURANT

ENFRIADOR DE COMBUSTIBLE

FUEL COOLER

SCAMBIATORE DI CALORE







REFROIDISSEUR DE CARBURANT

REF	OEM		
REC802630T01	802630T01 802630001 802630T 802630 8M0069803	MCM/MIE 7.4L MPI (L29) 496 Mag 8.1L	
REC860349A1	860349A1	MCM/MIE 7.4L/LX MPI 454 Mag MPI 502 Mag MPI MIE 8.2L MPI	
REC861126A1	861126A1	MCM 4.3 MPI 5.0 MPI, 350 Magnum, 8.1 L 6.2 MPI 7.4 MPI	MARRÓN, AZUL/VERDE BROWN & BLUE/GREEN MARRONE, BLU/VERDE MARRON, BLEU/VERD
REC807952A1	807952A1	MCM/MIE GM V-6 V-8 305, 350, 377 EFI/MPI, MCM 575SCi	ROSA PINK ROSA ROSE



CARRIL DE COMBUSTIBLE		FUEL RAIL	BINARIO DI ALIMENTAZIONE	RAIL DE CARBURANT
REF	OEM			
REC885174	885174	4.3L, 5.0L, 5.7L & 6.2L MPI (555 ECM)	REC885174	REC849899
REC849899	849899	MCM 500 EFI (Race sterndrive)		
REC805227A1	805227A1	MCM/MIE 7.4L/LX MPI, 454 & 502 Mag MPI, 8.2L MPI		REC805227A1

TAPA DEL MÓDULO		MODULE COVER	COPERCHIO DEL MODULO	COUVERCLE DU MODULE
REF	OEM			
REC892681	892681	5.0L MPI 5.7L MPI 350 Magnum 6.2L MPI 496 Magnum 8.1L 8.2L 502 Mag MPI 375HP 425HP 520, 540 (Race sterndrive)		

INYECTORES		INJEKTOR	INIETTORE	INJECTEURS
REF	OEM			
REC8M6002428	8M6002428 8M6000652 8M0057686	4.5L MPI (2A441953+) 6.2L MPI (2A456613+)	REC885176	885176
				MCM/MIE 4.3L MPI, 5.0L MPI, 350 Mag MPI, MX 6.2L MPI engines w/ECM555
REF	OEM			
REC802632T	802632T 802632	MCM/MIE 7.4L MPI (L29)	REC3858941	852956A1
				MCM GM V6 & V8 (305 & 350 cid) TBI
REF	OEM			
REC881693002	881693002	MCM 496 Mag & HQ, MIE 8.1S & HQ		

KIT RETENES DE INYECTOR

FUEL INJEKTOR SEAL KIT

KIT PARAOLIO INIETTORE

KIT JOINTS D'INJECTEUR

REF	OEM	
REC9-33304	802632T 849896	802632T Et 849896 MCM/MIE 7.4L MPI (L29)



REF	OEM	
REC9-33301	885176	885176 MCM/MIE 4.3L, 5.0L, 350 Mag MPI, MX 6.2L w/ECM 555



REF	OEM	
REC9-33302	861260T 861260	861260T 350 Mag MPI (1998+) MX 6.2L MPI, 7.4L/502 Mag MPI (1999+) 8.2L MPI



REF	OEM	
REC9-33303	805225A1	805225A1 MCM/MIE Ski GM V-8 350, 377, 454, 502 MPI



REF	OEM	
REC853998A1	853998A1 851956A1 853998T 853998	852956A1 MCM GM V-6 Et V-8 (305 Et 350) TBI



P
14



REF

STA93008
STA93016

P
15



REF

GE22207

CARBURADOR

CARBURATOR

CARBURATORE

CARBURATEUR

CARBURADORES
REMANUFACTURADOS

REBUILT CARBURATORS

CARBURATORI
RIGENERATI

CARBURATEURS
REMANUFACTURÉS

ROCHESTER

REF	OEM	
REC3304-9354A2	3304-9354A2 1347-804623R1/02	4



ROCHESTER

REF	OEM	
REC1347-9661A3	1347-9661A3 1347-8296A4 1347-7361A1 1347-7364A1	4

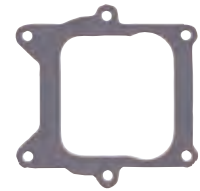

ROCHESTER

REF	OEM	
REC804626R02	1347-8288A1 1347-804626R1 804626R02 1347-6493A1 1347-8291A3 1347-7363A1 1347-7366A	4



ROCHESTER

REF	OEM	
REC1348-818621R02	1348-818621/R02 1347-8186211 1347-818621R02 1351-8480A2	2



ROCHESTER

REF	OEM	Icon
REC1347-818619R02	1347-818619/R02	2
	1347-8186191	
	1351-4263A1	
	1351-7354A1	
	1336-3594A1	
	1351-4263A2/A3	
	1351-5202A1	
	1351-6065A2	



ROCHESTER

REF	OEM	Icon
REC1376-818622R02	1376-818622R02	2
	1347-818622	
	1376-5659A1	
	1347-8186221	
	1376-5744A1	
	1376-6152A1	



ROCHESTER

REF	OEM	Icon
REC3310-807312A1	3310-807312A1	2
	3310-807312R02	
	1389-9670A2	



CARBURADORES NUEVOS NEW CARBURATORS CARBURATORI NUOVI CARBURATEUR NOUVEAU

HOLLEY

REF	Icon	Icon
MP426422	2	4.3L 500 CFM





HOLLEY

REF	Icon	Icon
MP426574	4	5.7 L 600 CFM



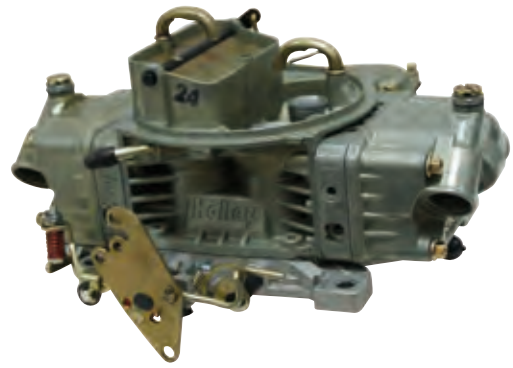

HOLLEY

REF		
MP426766	4	7.4 L 750 CFM





Q-JET

REF	OEM		
REC1347-816373A4	1347-816373A4	4	MCM 260, 350 MAG, 5.0L, 5.0LX, 5,7. (1982-95)
	1347-804624R02		
	3310-804624R1		
	1347-6492A1		
	1347-7362A1		
	1347-8292A4		
	1347-9662A4		
1347-9415T			





MERCARB

REF	OEM		
REC3310-864941A01	3310-864941A01	2	4.3L (2002-04) (OM615000- OW300012)





MERCARB



REF	OEM		
REC3310-864943A01	3310-864943A01	2	5.7 GM350 V8 (1998-01) 5.7 CARB ALPHA BRAVO 5.7 CARB MIE 5.7 CARB SKY 5.7 COMPETITION SKI (GEN+) GM 350 V8 (1998) 5.7L 1998+
	3310-861245A1		

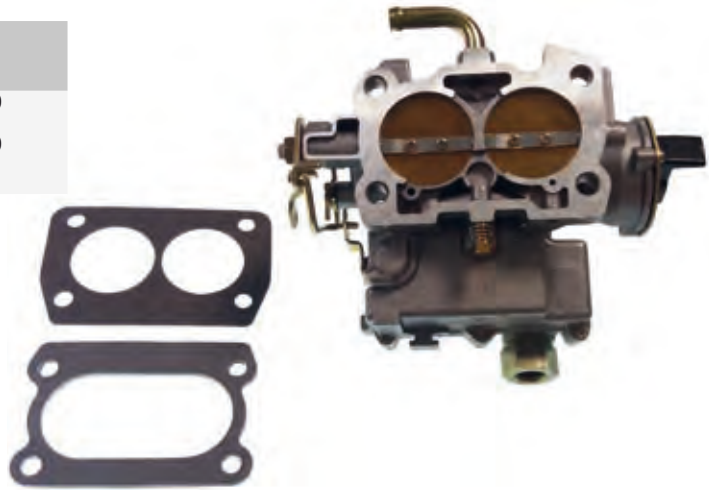

MERCARB

REF	OEM		
REC3310-864942A01	3310-864942A01 3310-861448A1	2	5.0L ALPHA/BRAVO (-OM623982) 5.0L ALPHA/BRAVO (OM623983+) 5.0L (1998-04)



REF	OEM		
REC3310-860070A2	3310-860070A2 1389-9562A1 3310-806077A2 3310-860070A2 3310-9562A1 3310-9350A2 3310-806078A2 3310-815396A2	2	120, 140, 2.5 L & 3.0L

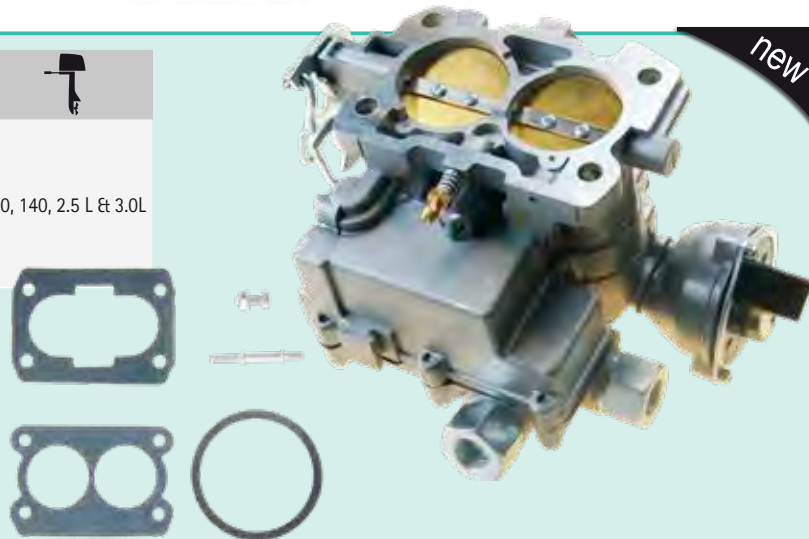

KITS ADAPTADORES CARBURADORES

CARBURETORS ADAPTER KITS

KIT ADATTATORE CARBURATORI

KIT ADPATATEURS DE CARBURATEURS

HOLLEY

REF
RECHOL17-6

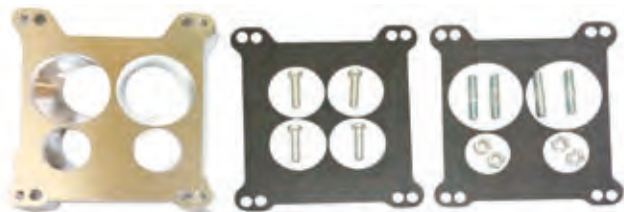

CABLE MCM A HOLLEY
MCM TO HOLLEY CABLE
CAVI MCM A HOLLEY
CÂBLE MCM A HOLLEY

REF
RECHOL717-7



TUBO COMBUSTIBLE BOMBA A CARBURADOR

FUEL TUBE FROM PUMP TO CARBURETOR

TUBO DA COMBUSTIBILE A POMPA CARBURATORI

TUYAU CARBURANT, POMPE A CARBURATEUR

REF	
REC18-8115	3/8" x 25 - 5/8"
REC18-8114	3/8" x 31" - 5/8"



BOYAS **FLOATS** **GALLEGGIANTI** **FLOTEURS**

ROCHESTER

REF	OEM	
REC1397-2060	1397-2060	2





ROCHESTER

REF	OEM	
REC1397-3327	1397-3327 1397-8546 1397-8959	4





ROCHESTER & MERCAB

REF	OEM	
REC3302-9031	1397-5837 3302-9031	2



WEBER

REF	OEM	
REC811536T	811536T 811536	4



KIT AGUJAS **INLET NEEDLE KIT** **KIT SPILLO** **KIT POINTEAU**

WEBER

REF	OEM	
REC823727	823727	V6



MERCAB

REF	OEM	
REC3302-804689	3302-804689	Moderno New style Modello moderno Model moderne

WEBER

REF	OEM	
REC811534	811534	V8



MERCAB

REF	OEM	
REC3302-9407	3302-9407	Antiguo Old style Modello vecchio Ancien model





 P14

REF
GEGC15

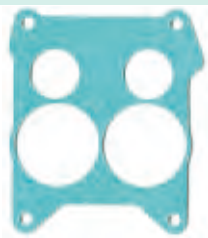

JUNTAS DE CARBURADOR CARBURETOR GASKETS

REF	OEM
REC27-48399	27-48399



REF	OEM	5.7L & 7.4L MPI
REC27-805396	27-805396	



ROCHESTER

REF	OEM	4
REC27-64692	27-64692	

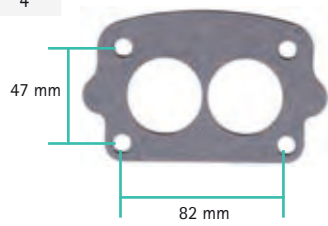

GUARNIZIONE CARBURATORI

HOLLEY

REF	OEM	4
REC27-65577	27-65577	
REC27-41609	27-41609	
REC27-70142	27-70142	2
REC27-60715	27-60715	2

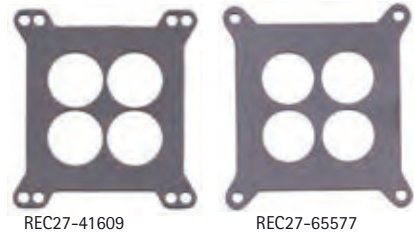

ROCHESTER & WEBER

REF	OEM	4
REC27-524572	27-524572	
	8079821	
REC27-8079821	27-8079821	2
	27-70143	
	27-701431	
	27-807982	

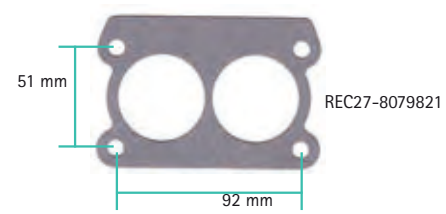

KIT JUNTAS DE CARBURADOR

REF	OEM
REC823427A1	823427A1
	1397-8873
	1397-8872
	1397-7547
	1397-7542
	1397-3459
	1397-2634
	1397-2067

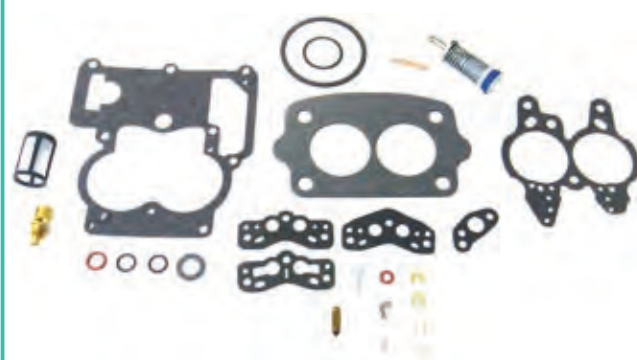

CARBURETOR GASKETS KIT

KIT GUARNIZIONE CARBURATORI

REF	OEM
REC1397-8760	1397-8760
	1397-5830
	1397-7099

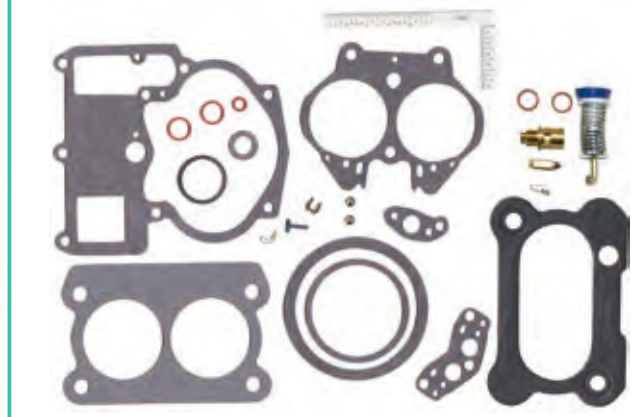

KIT JOINTS CARBURATEURS

REF	OEM
REC1397-6367A1	1397-6367A1

REF	OEM
REC1398-3089	1398-3089 1346-2770

REF	OEM
REC1396-4656	1396-4656

REF	OEM
REC13220	13220

WEBER

REF	OEM	Quantity
REC809064	809064	4
	809065	
REC809065	835076	4
	823728	

MERCAB

REF	OEM
REC3302-804845	3302-9437 3302-804845

MERCAB



FORD + ROCHESTER

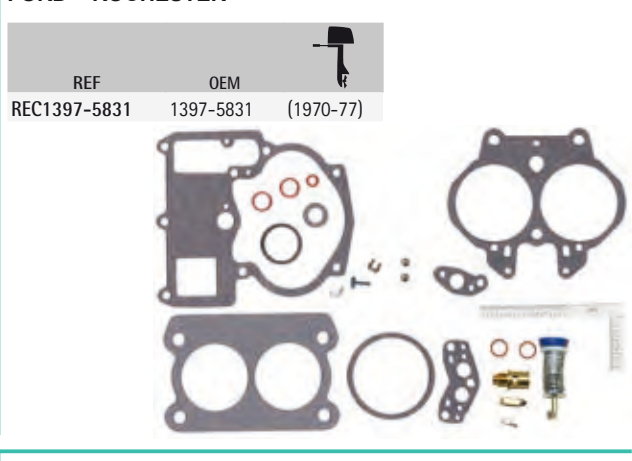

FORD

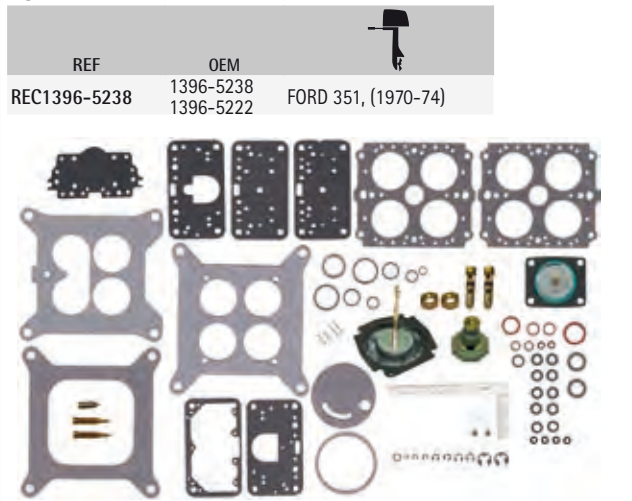

ROCHESTER

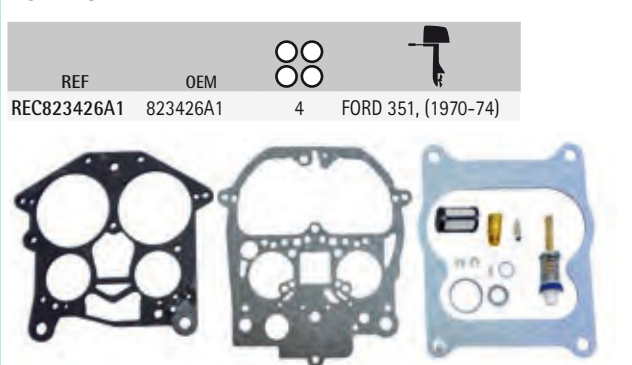





GUÍA CARBURADORES





GUIDE CARBURETORS





GUIDA CARBURATORI



GUIDE DES CARBURATEURS

Icon	Icon	SERIE SERIAL	CARB.	KIT CARB.	BASE	KIT	Icon
ROCHESTER							
90/ L4	2	1970-72	2851424-3226957	REC1347-818619R02	REC823427A1	REC27-64692	REC1397-2060
110/ L4	2	1963-66	1357370-2044033	REC1347-818619R02	REC823427A1	REC27-64692	REC1397-2060
120/ L4	2	1972-82	3377341-6229717	REC1347-818619R02	REC823427A1	REC27-64692	REC1397-2060
120/2.5L L4	2	1983-89	6229718-0C853255	REC1347-818619R02	REC823427A1	REC27-64692	REC1397-2060
120 (GM153) L4	2	1983-86	6229718-0B531853	REC1348-818621R02	REC823427A1	REC27-64692	
140 (GM181) L4	2	1982-86	6229718-0B450800	REC1348-818621R02	REC823427A1	REC27-64692	
140 (GM181) L4	2	1968-78	02816417-09999999		REC823427A1	REC27-64692	REC1397-2060
140 (GM181) L4	2	1979-82	5157669-6229717		REC823427A1	REC27-64692	REC1397-2060
2.5L (GM153) L4	2	1987-89	0B531854-0C856558	REC1348-818621R02	REC823427A1	REC27-64692	
3.0L (GM181) L4	2	1987-89	0B450801-0C856558	REC1348-818621R02	REC823427A1	REC27-64692	
205 (4.3L/LX)	4	1987	0B527955-0B775129	REC3304-9354A2	REC823426A1	REC27-524572	REC1397-3327
205 (4.3L)	4	1985-87	0A331455-0B527954	REC3304-9354A2	REC823426A1	REC27-524572	REC1397-3327
4.3L /LX	4	1988-92	0B775130-0D714106	REC3304-9354A2	REC823426A1	REC27-524572	REC1397-3327
898/200/5.0L	2	1987-95	0B525982-0F600999	REC3310-807312A1	REC3302-804845	REC27-8079821	REC3302-9031
228 (GM305)	4	1977-84	4765100-0B525981	REC1347-9661A3	REC823426A1	REC27-524572	REC1397-3327
228 MIE (GM305)	4	1977-80	4765100-5907057	REC1347-9661A3	REC823426A1	REC27-524572	REC1397-3327
230 MIE (GM305)	4	1987-95	0B522506-0B788151	REC1347-9661A3	REC823426A1	REC27-524572	REC1397-3327
230 (GM305)	4	1985-87	6218462-0B773799	REC1347-9661A3	REC823426A1	REC27-524572	REC1397-3327
5.0LX (GM305)	4	1988-95	0B773740-0F600999	REC1347-9661A3	REC823426A1	REC27-524572	REC1397-3327
233 (351) FORD	2	1975-77	00000000-09999999	REC1376-818622R02	REC1397-8760	REC27-70142	REC3302-9031
233 MIE (351) FORD	2	1975-76	00000000-09999999	REC1376-818622R02	REC1397-8760	REC27-70142	REC3302-9031
888 (302) FORD	2	1971-77	3108723	REC1376-818622R02	REC1397-8760	REC27-70142	REC3302-9031
5.7L (2BBL)	2	1996-97	F601000-K999999	REC3310-807312A1	REC3302-804845	REC27-8079821	REC3302-9031
5.7L SKI	2	1996-97	0F775200-0K999999	REC3310-807312A1	REC3302-804845	REC27-8079821	REC3302-9031
260/5.7MIE	4	1987-93	0B522506-0F024999	REC1347-816373A4	REC823426A1	REC27-524572	REC1397-3327
260	4	1978-86	4908850-0B525981	REC1347-816373A4	REC823426A1	REC27-524572	REC1397-3327
260/5.7L ALPHA	4	1987-93	0B525982-0F000454	REC1347-816373A4	REC823426A1	REC27-524572	REC1397-3327
5.7L BRAVO (w/o High Rise Intake)	4	1987-91	0B525982-0D617327	REC1347-816373A4	REC823426A1	REC27-524572	REC1397-3327

		SERIE SERIAL	CARB.	KIT CARB.	 BASE	 KIT	
5.7L SKI	4	1985-93 0A338533-0F025099	REC1347-816373A4	REC823426A1	REC27-524572		REC1397-3327
300MR/TRS	4	1985-86 6668677-0B430367	REC1347-816373A4	REC823426A1	REC27-524572		REC1397-3327
330 MCM	4	1977-87 4623115-0B816540	REC804626R02	REC823426A1	REC27-524572		REC1397-3327
330 MIE	4	1977-80 4623115-5889913	REC804626R02	REC823426A1	REC27-524572		REC1397-3327
340/7.4L MIE	4	1981-92 5889914-0D715493	REC804626R02	REC823426A1	REC27-524572		REC1397-3327
7.4L BRAVO I/II	4	1988-91 0B771113-0D603117	REC804626R02	REC823426A1	REC27-524572		REC1397-3327
454 MAG ALPHA	4	1986-88 0A631894-0B785148	REC804626R02	REC823426A1	REC27-524572		REC1397-3327
MERCARB & WEBER							
120 (CID 153/ CYL L4)		1984	REC3310-860070A2	REC3302-804845		REC3302-9407	
120 (CID 153/ CYL L4)		1985	REC3310-860070A2	REC3302-804845		REC3302-9407	
120 (CID 153/ CYL L4)		1986	REC3310-860070A2	REC3302-804844002		REC3302-9407	
2.5L (CID 153/ CYL L4)		1987-89	REC3310-860070A2	REC3302-804844002		REC3302-9407	
140 (CID 181/ CYL L4)		1984	REC3310-860070A2	REC3302-804845		REC3302-9407	
140 (CID 181/ CYL L4)		1985	REC3310-860070A2	REC3302-804845		REC3302-9407	
140 (CID 181/ CYL L4)		1986	REC3310-860070A2	REC3302-804844002		REC3302-9407	
3.0L (CID 181/ CYL L4)		1987-89	REC3310-860070A2	REC3302-804844002		REC3302-9407	
3.0L (CID 181/ CYL L4)		1990	REC3310-860070A2	REC3302-804844002		REC3302-804689	
3.0L (CID 181/ CYL L4)		1991-93	REC3310-860070A2	REC3302-804844002		REC3302-804689	
3.0L (CID 181/ CYL L4)		1993-94	REC3310-860070A2	REC3302-804844002		REC3302-804689	
4.3LH (GEN+)	4	1998 0L010044-0M614999		REC809065	REC27-524572	REC823727	REC811536T
4.3L CARB ALPHA/BRAVO	2	0M615000-0W300012	REC3310-864941A01	REC3302-804844002	REC27-8079821	REC3302-804689	REC3302-9031
5.0L CARB ALPHA/BRAVO	2	0M600000 +	REC3310-864942A01	REC3302-804844002	REC27-8079821	REC3302-804689	REC3302-9031
5.0L GM305 V-8	2	1998 0L015751-0M599999	REC3310-864942A01	REC3302-804844002	REC27-8079821	REC3302-804689	REC3302-9031
5.7 CARB ALPHA/BRAVO	2	0M600000 +	REC3310-864943A01	REC3302-804844002	REC27-8079821	REC3302-804689	REC3302-9031
5.7L CARB MIE	2	0L002003-0W090899	REC3310-864943A01	REC3302-804844002	REC27-8079821	REC3302-804689	REC3302-9031
5.7L CARB SKY	2	0M317000-0W090899	REC3310-864943A01	REC3302-804844002	REC27-8079821	REC3302-804689	REC3302-9031
5.7L GM350V-8	2	1998-01 0L010037-0M599999	REC3310-864943A01	REC3302-804844002	REC27-8079821	REC3302-804689	REC3302-9031
5.7L COMPETITON SKY(GEN+)	2	1998 0L002005-0M316999	REC3310-864943A01	REC3302-804844002	REC27-8079821	REC3302-804689	REC3302-9031
7.4L MIE	4	1995-97 0F350000-0K999999		REC809064	REC27-41609	REC811534	REC811536T
7.4L BRAVO I/II	4	1995-97 0F352000-0K999999		REC809064	REC27-41609	REC811534	REC811536T
7.4L BRAVO III	4	1996-97 0F800700-0K999999		REC809064	REC27-41609	REC811534	REC811536T
TKS							
5.0L CARB ALPHA/BRAVO	2	0M600000-0W300009		REC3302-804844002	REC27-8079821	REC3302-804689	REC3302-9031
5.0L CARB ALPHA/BRAVO	2	0W300010 +		REC3302-804844002	REC27-8079821	REC3302-804689	REC3302-9031
5.7L CARB ALPHA/BRAVO	2	0M600000-0W300009		REC3302-804844002	REC27-8079821	REC3302-804689	REC3302-9031
5.7L CARB ALPHA/BRAVO	2	0W300010 +		REC3302-804844002	REC27-8079821	REC3302-804689	REC3302-9031
5.7 CARB MIE	2	0M317000-0W689999		REC3302-804844002	REC27-8079821	REC3302-804689	REC3302-9031
5.7 CARB MIE	2	0W690000 +		REC3302-804844002	REC27-8079821	REC3302-804689	REC3302-9031
5.7 CARB SKY	2	0M317000-0W689999		REC3302-804844002	REC27-8079821	REC3302-804689	REC3302-9031
5.7 CARB SKY	2	0W694844 +		REC3302-804844002	REC27-8079821	REC3302-804689	REC3302-9031

	SERIE	OEM	CARB	KIT		 BASE	 KIT
MCM 120/2.5L	2520425-3377340	1336-3594A1	R2/2GC		REC1397-2060	REC27-64692	
	337341-3770649	1351-4263A3	R2/2GC	REC823427A1	REC1397-2060	REC27-64692	
	3770650-4469865	1351-5202A1	R2/2GC	REC823427A1	REC1397-2060	REC27-64692	
	4469866-5192048	1351-6065A2	R2/2GC	REC823427A1	REC1397-2060	REC27-64692	
	5192049-6229717	1351-7354A1	R2/2GC	REC823427A1	REC1397-2060	REC27-64692	
	6229718-0C853255	1351-8480A2	R2/2GC	REC823427A1		REC27-64692	
	6229718-0C853255	1389-8490A2	M2/MERCARB	REC3302-804844002	REC3302-9031	REC27-8079821	REC3302-9407
	6229718-0C853255	1389-9350A2	M2/MERCARB	REC3302-804844002	REC3302-9031	REC27-8079821	REC3302-9407
	6229718-0C853255	1389-9562A1	M2/MERCARB	REC3302-804844002	REC3302-9031	REC27-8079821	REC3302-9407
	2816417-2911439	1351-4032A1	R2/2GC	REC823427A1	REC1397-2060	REC27-64692	
	2911440-3771644	1351-4293A1	R2/2GC	REC823427A1	REC1397-2060	REC27-64692	
	3771645-5157668	1351-5203A1	R2/2GC	REC823427A1	REC1397-2060	REC27-64692	
MCM 140/3.0L/3.0LX (4 Cil.)	5157669-6229717	1351-7355A1	R2/2GC	REC823427A1	REC1397-2060	REC27-64692	
	6229718-0C856556	1351-8480A2	R2/2GC	REC823427A1		REC27-64692	
	6229718-0C856556	1389-8490A2	M2/MERCARB	REC3302-804844002	REC3302-9031	REC27-8079821	REC3302-9407
	6229718-0C856556	1389-9350A2	M2/MERCARB	REC3302-804844002	REC3302-9031	REC27-8079821	REC3302-9407
	6229718-0C856556	1389-9562A1	M2/MERCARB	REC3302-804844002	REC3302-9031	REC27-8079821	REC3302-9407
	0C856559-0D447414	1389-815396A2	M2/MERCARB				
	0D447415-0D836075	1389-9562A1	M2/MERCARB	REC3302-804844002	REC3302-9031	REC27-8079821	REC3302-9407
0D836076-0F603999	1389-815396A2	M2/MERCARB					
LX 0C856559+	1389-815397A2	M2/MERCARB					

	SERIE	OEM	CARB	KIT		 BASE	 KIT
MCM 165/170/3.7L (4 Cil.)	6916779	1389-9564A1	M2/MERCARB	REC3302-804844002	REC3302-9031	REC27-8079821	REC3302-9407
MCM470	4208730-6916778 6218037-6916778	1376-5990A1 1389-8489A5	R2/2GC M2/MERCAB	REC823427A1 REC3302-804844002	REC3302-9031 REC3302-9031	REC27-8079821 REC27-8079821	REC3302-804689
MCM185 (229CID)	6330183-6919655	3300-8886A 2	R4/4ME	REC823426A1	REC1397-2060	REC27-524572	
MCM485	5688394-6218036	1376-5990A1	R2/2GC	REC823427A1	REC3302-9031	REC27-64692	
MCM180/190/3.7LX	6916779	1347-9142A2	R4/4ME	REC823426A1	REC1397-3327	REC27-524572	
MCM488	6170297-6916778	1347-8460A3	R4/4ME	REC823426A1	REC1397-3327	REC27-524572	
MCM 175/185/4.3L V6	0A221455-0B527954 0A221455-0D714106 0F000878+	3304-9353A2 3304-9565A1 3310-80776A1	M2/MERCARB M2/MERCARB M2/MERCARB	REC3302-804845 REC3302-804844002 REC3302-804844002	REC3302-9031 REC3302-9031 REC3302-9031	REC27-8079821 REC27-8079821 REC27-8079821	REC3302-9407 REC3302-9407 REC3302-804689
MCM205/ 4.3LX/ 4.3LXH/LHV6	0A331455-0D714369 0D714370-0F802999	3304-9354A2 3310-807826A1	R4/4MV WEBER	REC823426A1 REC809064	REC1397-3327 REC811536T	REC27-524572 REC27-524572	REC823727
MCM198MIE/898-V8	4762210-0B525981	1376-8295A3	R2/2GC	REC1397-5831	REC3302-9031	REC27-8079821	
MCM898/200 V8	6218462-0B525981	1389-9563A1	M2/MERCARB	REC3302-804844002	REC3302-9031	REC27-8079821	REC3302-9407
MCM200/5.0L V8	0B525982-0F600999	1389-9670A2	M2/MERCARB	REC3302-804844002	REC3302-9031	REC27-8079821	REC3302-804689
MCM5.0L (GENE+) V8	0L157751+	3310-861448A1	M2/MERCARB		REC3302-9031	REC27-8079821	REC3302-804689
MCM888 V8	3108723-4887829 3108723-4887829	1356-4642 1376-5659A1	H2/2300 R2/2GC	REC1396-4656 REC1397-5831	REC3302-9031	REC27-60715 REC27-8079821	
MCM228/TR/MIE V8	4765100-5069430 4765100-5069430	1347-6427A1 1347-6438A1	R4/4MV R4/4MV	REC823426A1 REC823426A1	REC1397-3327 REC1397-3327	REC27-524572 REC27-524572	
MCM228V8	5069431-6021783 6021784-6218461	1347-7361A1 1347-8296A4	R4/4MV R4/4MV	REC823426A1 REC823426A1	REC1397-3327 REC1397-3327	REC27-524572 REC27-524572	
MCM228/230/5.0LX	6218462-0F600999	1347-9661A3	R4/4MV	REC823426A1	REC1397-3327	REC27-524572	
MCM228MIE V8	5069431-6040745	1347-7364A1	R4/4MV	REC823426A1	REC1397-3327	REC27-524572	
MCM230MIE V8	6040746-0B788151	1347-8290A1	R4/4MV	REC823426A1	REC1397-3327	REC27-524572	
MCM233/MIE V8	4173000-4465029 4465030-4902304	1346-57744A1 1346-6152A2	R2/2GC R2/2GC	REC1397-5831 REC1397-5831	REC3302-9031 REC3302-9031	REC27-8079821 REC27-8079821	
MCM250 (350CID) V8	4768000-4908849 4768000-4908849	1347-3353 1347-3237A3	R4/4MV R4/4MV	REC823426A1 REC823426A1	REC1397-3327 REC1397-3327	REC27-48399 REC27-48399	
MCM255/MIE (Ford)	3258728-4175499	1356-5169	H4/4160	REC17-8M0065070		REC17-14872A1	
MCM255/MIE V8	4175500-4924564 4924565-5195908 5195909-5907057	1347-5732A1 1347-7062A1 1347-7365A1	R4/4MV R4/4MV R4/4MV	REC823426A1 REC823426A1 REC823426A1	REC1397-3327 REC1397-3327 REC1397-3327	REC27-524572 REC27-524572 REC27-524572	
MCM260MIE V8	5907058-0B522505	1347-8289A1	R4/4MV	REC823426A1	REC1397-3327	REC27-524572	
MCM260MIE/ 5.7MIE	0B522506-0F024999 0F025000-0F349299	1347-9662A4 3310-806761A1	R4/4MV WEBER	REC823426A1 REC811536T	REC1397-3327 REC811536T	REC27-524572 REC27-524572	REC811534
MCM5.7MIE V8	0F025000-0F349299 0F025000-0F349299 0F349300-0F622099 0F622100-0K999999	3310-806761A2 3310-806761A3 3310-806762A2	WEBER WEBER WEBER		REC811536T REC811536T REC811536T	REC27-524572 REC27-524572 REC27-524572	REC811534 REC811534 REC811534
MCM5.7MIE (2BBL) 255 V8	0L002003+ 4175500-4767999	3310-861245A1 1347-5732A 1	MERCARB R4/4MV		REC3302-9031 REC1397-3327	REC27-8079821 REC27-524572	REC3302-804689
260 V8	4908850-5060805 5060806-6024393	1347-6492A 1 1347-7362A 1	R4/4MV R4/4MV	REC823426A1 REC823426A1	REC1397-3327 REC1397-3327	REC27-524572 REC27-524572	
260 V8/5.7L Alpha	6024393-0B525981	1347-8292A 1	R4/4MV	REC823426A1	REC1397-3327	REC27-524572	
5.7L Alpha V8	0B525982-0F000454 0F000455-0F273497 0F273498-0F600999	1347-9662A 4 3310-806761A 1 3310-806761A 3	R4/4MV WEBER WEBER	REC823426A1	REC1397-3327	REC27-524572 REC27-524572 REC27-524572	REC811534 REC811534 REC811534
5.7L (2BBL) V8	0F601000-0K999999	3310-807312A 1	MERCARB			REC27-8079821	REC3302-804689
5.7L (Gen+) (2BBL)	0L010037+	3310-861245A1	MERCARB			REC27-8079821	REC3302-804689
5.7LX (4BBL) V8	0F601000-0K999999	3310-807262A 2	WEBER			REC27-524572	REC811534
5.7L Bravo V8	0B525982-0D617327 0B525982-0D617327 0B525982-0D617327	1347-9662A 4 1347-8289A 1 3310-806970A 1	R4/4MV R4/4MV WEBER	REC823426A1 REC823426A1	REC1397-3327 REC1397-3327	REC27-524572 REC27-524572 REC27-524572	REC811534
350 Magnum Alpha	0A635178-0D617327 0D617328-0F600999 0F601000-0K999999	1347-8289A 1 3310-806970A 1 3310-807262A 2	R4/4MV WEBER WEBER	REC823426A1	REC1397-3327 REC811536T REC811536T	REC27-524572 REC27-524572 REC27-524572	REC811534 REC811534 REC811534
5.7L Ski V8	0A338533-0F025099 0F025100-0F449999 0F450000-0F775199	1347-9415T 3310-806761A 2 3310-806761A 3	R4/4MV WEBER WEBER	REC823426A1	REC1397-3327 REC811536T REC811536T	REC27-524572 REC27-524572 REC27-524572	REC811534 REC811534 REC811534
5.7L Ski (2BBL) V8	0F775200-0K999999	3310-807312A 1	MERCARB		REC3302-9031	REC27-8079821	REC3302-804689
5.7L Ski (Gen+) (2BBL) V8	0L002005+	3310-861245A 1	MERCARB		REC3302-9031	REC27-8079821	REC3302-804689
350 MAG Ski V8	0D505450-0K999999 0K040400-0K999999	3310-807262A 2 3310-860371A 1	WEBER WEBER		REC811536T REC811536T	REC27-524572 REC27-524572	REC811534 REC811534
270 MCM/MIE V8	2851074-3385720	1347-4180A 1	R4/4MV	REC823426A1	REC1397-3327	REC27-524572	
280 TRS V8	4176250-4176468 4176469-4770199	1347-4179A 2 1347-5981A 1	R4/4MV R4/4MV	REC823426A1 REC823426A1	REC1397-3327 REC1397-3327	REC27-524572 REC27-524572	
300 MR/TRS V8	6668677-0B430367 2278747-3042730	1347-7498A 7 1347-3342	R4/4MV R4/4MV	REC823426A1 REC823426A1	REC1397-3327 REC1397-3327	REC27-524572 REC27-524572	
325 MCM/MIE V8	3042731-3780449 2278747-3080449	1347-4533A 1 1347-3689A 1	R4/4MV R4/4MV	REC823426A1 REC823426A1	REC1397-3327 REC1397-3327	REC27-524572 REC27-524572	

	SERIE	OEM	CARB	KIT		 BASE	 KIT
330 MCM V8	4623115-5027230	1347-6493A 1	R4/4MV	REC823426A1	REC1397-3327	REC27-524572	
	5027231-6083144	1347-7363A 1	R4/4MV	REC823426A1	REC1397-3327	REC27-524572	
	6083145-0816540	1347-8291A 3	R4/4MV	REC823426A1	REC1397-3327	REC27-524572	
330 MIE V8	4623115-5226384	1347-6493A 1	R4/4MV	REC823426A1	REC1397-3327	REC27-524572	
	5226385-5889913	1347-7366A 1	R4/4MV	REC823426A1	REC1397-3327	REC27-524572	
340/7.4L MIE V8	5889914-0D715493	1347-8288A 1	R4/4MV	REC823426A1	REC1397-3327	REC27-524572	
7.4L Hurth V8	0D715494-0F349999	3310-80969A 2	WEBER		REC811536T	REC27-524572	REC811534
7.4L BORG WARNER V8	0D715494-0F349999	3310-80969A 3	WEBER		REC811536T	REC27-524572	REC811534
7.4L MIE V8	0F350000-0K999999	3310-86969A 1	WEBER		REC811536T	REC27-524572	REC811534
	0B771113-0D603117	1347-8291A 3	R4/4MV	REC823426A1	REC1397-3327	REC27-524572	
7.4L BRAVO I/II V8	0D603118-0F351999	3310-86969A 2	WEBER		REC811536T	REC27-524572	REC811534
	0F352000-0K999999	3310-86969A 1	WEBER		REC811536T	REC27-524572	REC811534
	0D838819-0F800699	3310-806755A 2	WEBER		REC811536T	REC27-524572	REC811534
7.4L BRAVO III V8	0F800700-0K999999	3310-806969A 1	WEBER		REC811536T	REC27-524572	REC811534
	4179554-0B714586	1347-7498A 2	R4/4MV	REC823426A1	REC1397-3327	REC27-524572	
370 V8	4179554-0B714586	1347-7498A 2	R4/4MV	REC823426A1	REC1397-3327	REC27-524572	
400 V8	TODOS - All	1347-7498A 2	R4/4MV	REC823426A1	REC1397-3327	REC27-524572	
420/425 V8	0A398941-0D937011	13549A 4	H4	REC13220			
440/460 V8	4179554-0B485220	1393-8862A 1	H4	REC13220			
450 V8	0F347100-0F347277	13549A 4	H4	REC13220			
454 MAG Alpha V8	0A631894-0B785148	1347-8291A 3	R4/4MV	REC823426A1	REC1397-3327	REC27-524572	
	0A631894-0B785148	1347-8291A 3	R4/4MV	REC823426A1	REC1397-3327	REC27-524572	
	0B721206-0D808068	1347-7498A 2	R4/4MV	REC823426A1	REC1397-3327	REC27-524572	
454 MAG Bravo V8	0D808069-0F304999	3310-806755A 1	WEBER		REC811536T	REC27-524572	REC811534
	0F305000-0K999999	3310-806755A 2	WEBER		REC811536T	REC27-524572	REC811534
465 V8	0C849992-0F213244	N/D	H4	REC13220			
500 (502 CID) V8	0F213293-0F615766	13549A12	H4	REC13220			
	0F615767+	13549T21	H4	REC13220			
500 Bulldog (540 CID) V8	0C577254-0F348987	13549A10	H4	REC13220			
	0F615767+	13549A23	H4	REC13220			
502 MAG V8	0C878221-0D824588	1347-814623A 2	R4/4MV	REC823426A1	REC1397-3327	REC27-524572	
	0D824589-0F114528	3310-806971A 1	WEBER		REC811536T	REC27-524572	REC811534
8.2L MIE V8	0C878221-0D857199	1347-814623A 2	R4/4MV	REC823426A1	REC1397-3327	REC27-524572	
	0D878221-0F819619	3310-806971A 1	WEBER		REC811536T	REC27-524572	REC811534





CHOKE

REF	OEM	
REC1396-4148	1396-4148 HOLLEY	
REC809066	809066 WEBER 4v Carb (electric choke)	
REC70125A02	70125A02	
	70125A1 ROCHESTER & MERCAB 70125	



REC809066
REC1396-4148

REC70125A02

DEPRESOR	CHOKE PULL-OFF	DEPRESSORE	ÉTRANGLEUR PULL-OFF	TERMOSTATO	THERMOSTAT	TERMOSTATO	THERMOSTAT
REF	OEM			REF	OEM		
REC1397-8582	1397-8582 Rochester, 4v carb.			REC71464A01	71464 71464A01 72625 Rochester (divorced Choke)		

APAGALLAMAS FLAME ARRESTORS PARAFIAMMA ARRÊTEURS DE FLAMMES

REF	OEM	A	B	C	
REC861259	861259	6.04	3.94	9.40	
REC805016A1	805016A1	6.20	4.00	7.80	4 Et 6 Cyl.
REC85785A2	85785A2	5.71	3.73	12.83	V8
REC85784A1	85784A1	5.48	2.76	7.93	4 Et 6 Cyl.
REC805298A1	85785T	5.71	3.73	12.83	V8
	85785-2 805298A1				



REC861259

REC85785A2

REC805298A1





REC85784A1

REC805016A1

6.50

TURBO TURBO TURBINE TURBO

TURBO TURBO TURBINE TURBO

REF	OEM				
REC8M0098619	8M0098619 889341	CMD CMDQ 4.2 D4.2L / 300 D-TRONIC	REC27-8M0094247	RM21325765	<i>new</i>

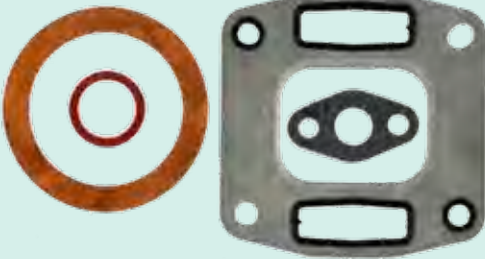

KIT JUNTAS PARA TURBO TURBO GASKET KIT KIT GUARNIZIONE PER TURBINE KIT JOINTS POUR TURBO

REF	OEM	TURBO	
REC27-8M0094247	24-8M0094247 27-898101475 27-801333454 27-854129	REC8M0098619	<i>new</i>

ABRAZADERA ESCAPE TURBO TURBO, EXHAUST CLAMP FASCETTA SCARICO TURBO COLLIER ECHAPPEMENT TURBO

REF	OEM		
RM21325765	864148A01 54-896332164 801763272 801331174 864148	D/CMD/QSD 1.7 / 2.0 / 3.0 / 3.6 / 2.8 / 4.2 D183, 219, 254, 530, 636 7.3L	<i>new</i>

RETÉN ACEITE DE TURBO TURBO, SEAL PARAOLIO TURBO JOINT SPI DE TURBO

REF	OEM		
REC25-811461	811461	2.8 / 4.2 D254	<i>new</i>

SISTEMA ELÉCTRICO ELECTRIC SYSTEM

SISTEMA ELETTRICO SYSTÈME ÉLECTRIQUE

SENSORES

SENSORS

SENSORE

CAPTEURS

SENSOR TPS

TPS SENDER



SENSORE TPS

CAPTEUR TPS

REF	OEM	
REC8M0125617	8M0125617	3.0L MPI MCM/MIE V-6 & 305, 350, 454, 502 EFI
	881070T	
	805226A1	



new

REF	OEM		
REC853678T	853678T	MCM/MIE 4.3L, 5.0L, MX 6.2L w/ECM555, 350 Mag MPI, BIK Scorpion Ski, 7.4L MPI (L29), MCM 496 Mag & HO, 8.1S & HO	
	853678		



REF	OEM		
REC803148	803148	MCM/MIE 350 Mag, BIK Scorpion Ski (0L005900 & +)	

SENSOR MAP



MAP SENSOR



SENSORE MAP

CAPTEUR MAP

REF	OEM		
REC8M0054726	881731 8M0054726	V6 & V8 MPI (555 ECM)	

REF	OEM		
REC854445	854445	MCM 525 EFI	

REF	OEM		
REC3850396	864856A1 805217A1	MCM/MIE GM V-6 & 350, 377, MX 6.2L MPI, 7.4L MPI, 454, 502 EFI	

REF	OEM		
REC861249A1	861249A1 861249	MCM/MIE GM V-6 & 305, 350, MX 6.2L MPI, 7.4L MPI (1998+) 5.0L, 5.7L EFI (1998)	

REF	OEM		
REC879150150	879150150 849934	MCM 575SCI	

SENSOR MAT/MAP



MAT/MAP SENSOR





SENSORE MAT/MAP

CAPTEUR MAT/MAP

REF	OEM	
REC8M0087834	885165 8M0087834	350MAG MPI
		377MAG MPI
		383MAG STROKER
		4.3L MPI
		5.0L MPI
		5.7L MPI 6.2L MPI



SENSOR PICK UP		PICK UP SENSOR	SENSORE PICK UP	CAPTEUR PICK UP
REF	OEM			
REC3854001	811639 811639T	V4 / V6 / V8 Delco Voyager		

SENSOR DE OXÍGENO		OXYGEN SENSOR	SENSORE OSSIGENO	SONDE À OXYGENE
REF	OEM			
REC8M2003959	8M2003959	3.0 MPI, 4.3 MPI, 4.5 MPI, 6.2 MPI, 5.0L MPI, 5.7L MPI 8.2/377		
REF	OEM			
REC8M0142695	8M0142695 8M0095468	4.5 MPI, 6.2 MPI		

VÁLVULA DE AIRE, IAC		AIR VALVE, IDLE	VALVOLA ARIA	SOUPAPE D'AIRE
REF	OEM			
REC862998	862998	3.0L MPI, 4.3 MPI, 5.0L MPI, 350 MAG MPI, MX6.2 MPI, 8.1L 600, 662, 700 (Race sterndrive)		

SENSOR IAC		IAC SENDER	SENSORE IAC	SONDE IAC
REF	OEM			
REC3855194	805224A1	MCM/MIE GM V-6 & 305, 350, 454, 502 EFI 500, 575 (Race sterndrive)		
REF	OEM			
REC3843751	803149	MCM/MIE 350 Mag MPI Black Scorpion Ski, 377 Scorpion, MCM & Ski MX 6.2L MPI, 7.4L MPI (L29), 575SCi		

SENSOR PICADO		KNOCK SENDER	SENSORE DI CADUTA	CAPTEUR DE CLIQUETIS
REF	OEM			
REC8M0077616	805544T 8M0077616	454, 502, 540, 572 7.4L, 454 MAGNUM 8.2L 500, 525, 575, 600, 800 (Race sterndrive)		
REF	OEM			
REC806612T	806612T	MCM/MIE 305, 350, 377 GM V8 CID		

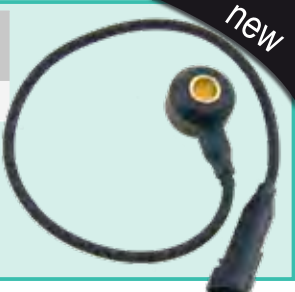
SENSOR PICK UP		PICK UP SENSOR	SENSORE PICK UP	CAPTEUR PICK UP
REF	OEM			
REC8M6003194	8M6003194 878187	V6 & V8		

SENSOR POSICIÓN ÁRBOL DE LEVAS CAMSHAFT SENSOR

SENSORE POSIZIONE ASSE A CAMME

SONDE POSITION ARBRE À CAMMES

REF	OEM	
REC3863130	898141	3.0, 4.3, 5.0, 5.7, 6.2L



Se instala en distribuidor
Is installed in distributor
Viene installato nello spinterogeno
Installé dans le distributeur

SENSOR POSICIÓN CIGÜENAL CRANKSHAFT SENSOR

SENSORE POSIZIONE ALBERO MOTORE

SONDE POSITION VILEBREQUIN

REF	OEM	
REC892617	892617	8.1L 496 Mag, H.O. BRAVO

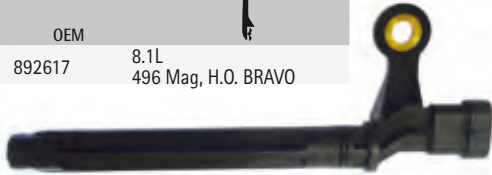

REF	OEM	
REC892615002	892615002 892615001 892615	MCM 496 Mag, 8.1 Inboard



REF	OEM	
REC864297T01	864297T01 864297 864297001	350 Magnum, 377 Magnum MPI, 5.0L MPI, 5.7L MPI, 6.2L MPI, 8.2L MPI 4.3L CARB / MPI 525, 600, 662, 700 (Race sterndrive)



REF	OEM	
REC8M0082988	8M0082988 8M0030022 8283582 828358	3.0L MPI



new

REF	OEM	
REC21124849	879194363	4.3 MPI 4.5MPI Et 6.2MPI



Cigüenial con tapa de AL
Crankshaft cup in AL
Albero motore con coperchio AL
Vilebrequin avec couvercle en AL



new

KIT SENSOR TRIM

TRIM SENSOR KIT

KIT SENSORI TRIM

KIT SONDE DE TRIM

REF	OEM	
REC805320A03	805320A03	MC-1, MR, ALPHA ONE, GEN II Et BRAVO



new

KIT SENSOR DIGITAL TRIM DIGITAL TRIM SENDER

SENSORE TRIM DIGITAL

SONDE DE TRIM DIGITAL

REF	OEM	
REC8M0095310	8M0095310	ALPHA ONE GEN II (1998+) BRAVO I,II, III (2A417474+)



new

KIT TEMPERATURA Y PRESIÓN DE ACEITE CON ALARMA

COMPLETE TEMPERATURE & OIL PRESSURE WARNING KIT

KIT TEMPERATURA E PRESSIONE DELL'OLIO CON ALLARME

KIT SONDE TEMPERATURE ET PRESSION D'HUILE AVEC ALARME

REF	OEM
REC41400	





SENSOR PRESIÓN DE ACEITE



OIL PRESSURE SENDER

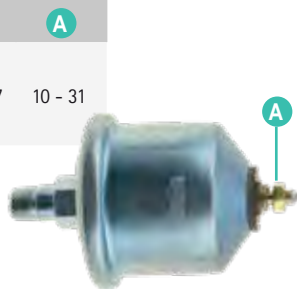

SENSORE PRESSIONE OLIO

SONDE PRESSION D'HUILE

REF	OEM		
REC8M0068784	87-815425T	1/8 - 27	10 - 31
	8M0068784		
	90806		
	815425 34623		



REF	OEM	
REC87-805605A1	3.0L (1990-95)	
	4.3L (1993-98)	
	5.0L (1988-01)	
	5.7L (1988-01)	
	7.4L (1991-00)	

REF	OEM		PSI
REC881879T11	881879T11		0-100
	881879A6		
	859210		
	859210T		
	859604A1		
	881879011		





SENSOR PRESIÓN ACEITE RAIL

OIL PRESSURE SENDER RAIL

SENSORE PRESSIONE OLIO RAIL

SONDE PRESSION D'HUILE RAIL

REF	OEM	
REC3843100	879172105	
CMD QSD 2.8, 4.2 2.0L EI, ES		





SENSOR ACEITE PARA BOMBA COMBUSTIBLE



ELECTRIC FUEL PUMP SWITCH SENSOR

SENSORE OLIO PER POMPA COMBUSTIBILE

SONDE D'HUILE POUR POMPE CARBURANT

REF	OEM	
REC87-864252	87-864252	
4.3, 5.0, 5.7 Motores modernos Later engines Motori moderno Moteurs modernes		



REF	OEM	
REC87-864252A01	87-864252A01	
4.3, 5.0, 5.7 Motores antiguos Old engines Motori vecchio Moteurs anciens		



SENSOR DE TEMPERATURA AIRE

AIR TEMPERATURE SENSOR

SENSORE TEMPERATURA ARIA

SONDE TEMPERATURE DE L'AIRE

REF	OEM	
REC805223T	805223T 805223	V6 Et V8 (350, 454, 496 Et 502 CID) EFI / MPI 500, 520, 525, 540, 575 (Race sterndrive)

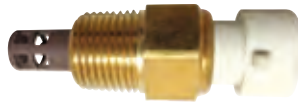

SENSOR TEMPERATURA ENFRIADOR

COOLANT TEMPERATURE SENDER

SENSORE TEMPERATURA SCAMBIATORE

SONDE TEMPERATURE DE REFROIDISSEUR

REF	OEM	
REC3850397	805218T 805218	350 MAG ,PI 383 MAG 4.3L MPI, 5.0L MPI, 3.0L MPI 6.2L MPI 357, 377 4.3 CARB, EFI 454, 496 MAG, EFI 5.7L CARB, EFI 8.1, 8.2L MIE



SENSOR CAUDAL DEL AGUA

WATER SENSOR

SENSORE ACQUA

SONDE DE L'EAU

REF	OEM		PSI
REC8M6000623	8M6000623 881879010 8818793	V6 Et V8 4.5L MPI	50



SENSOR TEMPERATURA AGUA

WATER TEMPERATURE SENDER

SENSORE TEMPERATURA ACQUA

SONDE TEMPERATURE DE L'EAU

REF	OEM	
REC97258A1	97258A1 97258 34625 F16900198 F16900152	1/2" - 14 NPT



REF	OEM	
REC806490T	806490T 97257A1 97-257 806490 811091 36525	3/8" - 18 NPT



REF	OEM
REC48952	48952





REF	OEM	
REC15995	15995	MCM 3.71

PARA RELOJES
FOR GAUGES
PER GLI OROLOGI
POUR LES GAUGES





new

REF	OEM	
REC8M0148668	8M0148668 885342002 885342001	6.2L MPI, 4.3L, 4.5L MPI, 3.0L MPI 8.1L, 8.2L MPI 496 MAG, 525 EFI



new

REF	OEM	
REC8M0142542	8M0142542	TRANSMISION: ZF63, 63A 3.0L VM V6 AXIUS SYSTEM



new

GUÍA DE SENSORES			SENSOR APPLICATION			GUIDA SENSORI		GUIDE DES SONDES				
MOD.	CYL		SERIE SERIAL SERIE SERIE	INYECTOR INJECTOR INNIETORE INJECTEUR	KIT	IAC	TPS	REGULADOR PRESIÓN REGULATOR PRESSURE REGOLATORE PRESSIONE REGULATEUR		MAP	PICADO KNOCK BATTITO CLIQUETIS	TEMP. AIRE AIR TEMP. TEMP. ARIA TEMP. AIRE
								RAIL	COOLER			
262 MAG EFI	262/V6	1996-97	OF803800-OK999999		REC3858941	REC3855194	REC8M0125617		REC807952A1	REC3850396		
4.3L EFI	262/V6	1998-01	OL012009-OM299999		REC3858941	REC3855194	REC8M0125617		REC807952A1	REC861249A1		REC805223T
4.3L MPI	262/V6	2002-07	OM300000+	REC885176	REC9-33301	REC862998	REC853678T	REC885174	REC807952A1			REC3850397
5.0L EFI	305/V8	1998-01	OL012052-OM299999		REC853998A1	REC3855194	REC8M0125617		REC807952A1	REC861249A1		REC805223T
5.0L MPI	305/V8	2002-07	OM300000+	REC885176	REC9-33301	REC862998	REC853678T	REC885174	REC861126A1			
5.0L MPI DTS	305/V8	2005-07	OW310000+	REC885176	REC9-33301			REC885174				
320 EFI	350/V8	1987-89	OA543604-OC622418			REC862998						
350 MAG ALPHA EFI (GEN+)	350/V8	1996-97	OF800300-OK999999		REC853998A1	REC3855194	REC8M0125617		REC807952A1	REC3850396	REC806612T	
350 MAG BRAVO MPI	350/V8	1995-96	OF415189-OK001500			REC3855194	REC8M0125617			REC3850396	REC806612T	
350 MAG BRAVO MPI (GEN+)	350/V8	1997	OK001501-OK999999		REC9-33303	REC3855194	REC8M0125617		REC807952A1	REC3850396	REC806612T	
	350/V8	1994-96	OF215561-OF820706		REC853998A1	REC3855194	REC8M0125617			REC3850396	REC806612T	
350 MAG EFI SKI	350/V8	1996	OF820707-OK040005		REC853998A1	REC3855194	REC8M0125617		REC807952A1	REC3850396	REC806612T	
	350/V8	1997	OK040006-OK999999		REC853998A1	REC3855194	REC8M0125617		REC807952A1	REC3850396	REC806612T	
	350/V8	1998	OL010019-OL331598		REC9-33302	REC3843751	REC853678T		REC807952A1	REC861249A1	REC806612T	
	350/V8	1998	OL336000-OL346999		REC9-33302	REC3843751	REC853678T		REC807952A1	REC861249A1	REC806612T	
350 MAG MPI	350/V8	1999	OL331599-OL-335999		REC9-33302	REC3843751	REC803148		REC807952A1	REC861249A1	REC806612T	REC805223T
	350/V8	1999-01	OL340000-OM299999		REC9-33302	REC3843751	REC803148		REC807952A1	REC861249A1	REC806612T	REC805223T
	350/V8	2002-07	OM300000+	REC885176	REC9-33301	REC862998	REC853678T	REC885174	REC861126A1			
350 MAG MPI DTS	350/V8	2005-07	OW310000+	REC885176	REC9-33301			REC885174				
350 MAG MPI HORIZON	350/V8	2002-07	OM300000+	REC885176	REC9-33301	REC862998	REC853678T	REC885174	REC861126A1			
350 MAG MPI HORIZON DTS	350/V8	2005-07	OW310000+	REC885176	REC9-33301			REC885174				
	350/V8	1999-01	OL304700-OM299999		REC9-33302	REC3843751	REC803148		REC807952A1	REC861249A1	REC806612T	
350 MAG MPI HORIZON MIE	350/V8	2002-04	OM300000-OM398371	REC885176	REC9-33301	REC862998	REC853678T		REC861126A1			
	350/V8	2004-07	OM398372+	REC885176	REC9-33301	REC862998	REC853678T	REC885174				
350 MAG MPI HORIZON MIE DTS	350/V8	2005-07	OW310000+	REC885176	REC9-33301			REC885174				
	350/V8	1998	OL002008-OL304999		REC9-33302	REC3843751	REC853678T		REC807952A1	REC861249A1	REC806612T	
350 MAG MPI MIE	350/V8	2002-04	OM300000-OM398371	REC885176	REC9-33301	REC862998	REC853678T	REC885174	REC861126A1			
	350/V8	2004-07	OM398372+	REC885176	REC9-33301	REC862998	REC853678T	REC885174				
350 MAG MPI MIE DTS	350/V8	2005-07	OW310000+	REC885176	REC9-33301			REC885174				
350 MAG EFI SKI	350/V8	1994-96	OF215561-OF820706		REC853998A1	REC3855194	REC8M0125617			REC3850396	REC806612T	
	350/V8	1998	OL002600-OL304599		REC9-33302	REC3843751	REC853678T		REC807952A1	REC861249A1	REC806612T	
350 MAG MPI SKI	350/V8	1999-01	OL304600-OM299999		REC9-33302	REC3843751	REC803148		REC807952A1	REC861249A1	REC806612T	
	350/V8	2002-07	OM300000+	REC885176	REC9-33301	REC862998	REC853678T	REC885174	REC861126A1			
5.7L EFI	350/V8	1995-97	OF225560-OK999999		REC853998A1	REC3855194	REC8M0125617		REC807952A1	REC3850396	REC806612T	
	350/V8	1998-01	OL010035-OM299999		REC853998A1	REC3855194	REC8M0125617		REC807952A1	REC861249A1	REC806612T	REC805223T
5.7L EFI (GEN+)	350/V8	1997	OK040300-OK999999		REC853998A1	REC3855194	REC8M0125617		REC807952A1	REC3850396	REC806612T	
5.7LX BRAVO EFI (GEN+)	350/V8	1996-97	OF800300-OK999999		REC853998A1	REC3855194	REC8M0125617		REC807952A1	REC3850396	REC806612T	
5.7LX EFI	350/V8	1995-97	OF225560-OK999999		REC853998A1	REC3855194	REC8M0125617		REC807952A1	REC3850396	REC806612T	
	350/V8	1996	OF350583-OK040000			REC3843751	REC853678T	REC885174		REC3850396	REC806612T	
	350/V8	1997	OK040001-OL002699		REC9-33303	REC3843751	REC853678T		REC807952A1	REC3850396	REC806612T	
BLACK SCORPION SKI	350/V8	1998	OL002700-OL005600		REC9-33303	REC3843751	REC853678T		REC807952A1		REC806612T	
	350/V8	1998-05	OL005601-OM391599		REC9-33303	REC3843751	REC803148		REC807952A1		REC806612T	
	350/V8	2003-07	OM391600+		REC9-33303	REC862998	REC803148		REC807952A1			
377 SCORPION MCM	377/V8	1999-05	OL416146-OM907201		REC9-33303	REC3843751	REC803148		REC807952A1	REC3850396	REC806612T	
377 SCORPION SKI	377/V8	1997-98	OK000656-OL600314		REC9-33303	REC3843751	REC853678T		REC807952A1	REC3850396	REC806612T	
	377/V8	2000-01	OL68003-OM299999		REC9-33302	REC3843751	REC803148		REC807952A1	REC861249A1	REC806612T	REC805223T
MX 6.2L MPI	377/V8	2002-04	OM300000-OW059999	REC885176	REC9-33301	REC862998	REC853678T	REC885174	REC861126A1			
	377/V8	2004-07	OW060000+	REC885176	REC9-33301	REC862998	REC853678T	REC885174				
MX 6.2 MPI DTS	377/V8	2005-07	OW310000+	REC885176	REC9-33301			REC885174				
MX 6.2L MPI HORIZON	377/V8	2002-04	OM300000-OW059999	REC885176	REC9-33301	REC862998	REC853678T	REC885174	REC861126A1			
	377/V8	2004-07	OW060000+	REC885176	REC9-33301	REC862998	REC853678T	REC885174				

MOD.	CYL		SERIE SERIAL SERIE SERIE	INYECTOR INJECTOR INNIETTORE INJECTEUR	KIT	IAC	TPS	REGULADOR PRESIÓN REGULATOR PRESSURE REGOLATORE PRESSIONE REGULATEUR		MAP	PICADO KNOCK BATTITO CLIQUETIS	TEMP. AIRE AIR TEMP. TEMP. ARIA TEMP. AIRE
								RAIL	COOLER			
MX 6.2L MPI HORIZON DTS	377/V8	2005-07	OW310000+	REC885176	REC9-33301	REC862998		REC885174				
MX 6.2L MPI HORIZON MIE	377/V8	2002-04	OM300000- OM398394	REC885176	REC9-33301	REC862998	REC853678T	REC885174	REC861126A1			
	377/V8	2004-07	OM398395+	REC885176	REC9-33301	REC862998	REC853678T	REC885174				
MX 6.2L MPI HORIZON MIE DTS	377/V8	2005-07	OW390000+	REC885176	REC9-33301			REC885174				
MX 6.2L MPI MIE	377/V8	2002-04	OM300000- OM398394	REC885176	REC9-33301	REC862998	REC853678T	REC885174	REC861126A1			
	377/V8	2004-07	OM398395+	REC885176	REC9-33301	REC862998	REC853678T	REC885174				
MX 6.2L MPI MIE DTS	377/V8	2005-07	OW390000+	REC885176	REC9-33301	REC862998		REC885174				
MX 6.2L MPI SKI	377/V8	2002-07	OM317000+	REC885176	REC9-33301	REC862998	REC853678T	REC885174	REC861126A1			
	377/V8	2001-03	OL005601- OM391599		REC9-33303	REC384375I	REC803148		REC807952A1		REC806612T	
MX 6.2L BLACK SCORPION SKI	377/V8	2003-07	OK391750+		REC9-33303	REC862998	REC803148		REC807952A1			
454 MAG EFI	454/V8	1994-96	OF115700- OF802349		REC9-33303	REC3855194	REC8M0125617	REC805227A1		REC3850396	REC8M0077616	REC805223T
454 MAG EFI SKI	454/V8	1994-96	OF215800- OF820099		REC9-33303	REC3855194	REC8M0125617	REC805227A1		REC3850396	REC8M0077616	REC805223T
	454/V8	1996-97	OF820099- OK999999		REC9-33303	REC3855194	REC8M0125617	REC805227A1		REC3850396	REC8M0077616	REC805223T
454 MAG MPI	454/V8	1996-97	OF802350- OK147349		REC9-33303	REC3855194	REC8M0125617	REC805227A1	REC3850396	REC8M0077616	REC805223T	REC805223T
	454/V8	1996-97	OK147350- OL085399		REC9-33303	REC3855194	REC8M0125617	REC805227A1	REC860349A1	REC3850396	REC8M0077616	REC805223T
454 MAG MPI HORIZON MIE	454/V8	1997-98	OL085400- OM024999		REC9-33302	REC3855194	REC8M0125617		REC861126A1	REC3850396	REC8M0077616	REC805223T
	454/V8	1999-01	OL002200- OL086049		REC9-33303	REC3855194	REC8M0125617	REC805227A1	REC860349A1	REC3850396	REC8M0077616	REC805223T
74.L MPI (L29)	454/V8	1998	OL086050- OL674000		REC9-33302	REC3855194	REC8M0125617		REC861126A1	REC3850396	REC8M0077616	REC805223T
	454/V8	1999-01	OL010003- OM024330	REC802632T	REC9-33304	REC384375I	REC853678T	REC802630T01	REC861126A1	REC861249A1	REC8M0077616	REC805223T
7.4L MPI MIE	454/V8	1998-01	OF503052- OK147349		REC9-33303	REC3855194	REC8M0125617	REC805227A1		REC3850396	REC8M0077616	REC805223T
	454/V8	1995-96	OK147350- OK999999		REC9-33303	REC3855194	REC8M0125617	REC805227A1	REC860349A1	REC3850396	REC8M0077616	REC805223T
7.4L MPI MIE (L29)	454/V8	1997	OL010003- OL674613	REC802632T	REC9-33304	REC384375I	REC8M0125617	REC802630T01	REC861126A1	REC861249A1	REC8M0077616	REC805223T
	454/V8	1998-01	OF820000- OK999999			REC3855194	REC8M0125617		REC807952A1	REC3850396	REC8M0077616	REC805223T
7:4LX MPI	454/V8	1996-97	OF602010- OK147349		REC9-33303	REC3855194	REC8M0125617	REC805227A1		REC3850396	REC8M0077616	REC805223T
	454/V8	1996	OK147350- OK999999		REC9-33303	REC3855194	REC8M0125617	REC805227A1	REC860349A1	REC3850396	REC8M0077616	REC805223T
496 MAG	496/V8	1997	OM025000- OW059999	REC881693002		REC862998	REC853678T	REC802630T01	REC861126A1			
	496/V8	2001-04	OW060000+	REC881693002		REC862998	REC853678T	N.S.S.	REC892681	REC8M0054726		
496 MAG DTS	496/V8	2004-07	OM025000- OW059999	REC881693002				REC802630T01	REC861126A1			
	496/V8	2001-04	OW060000+	REC881693002				N.S.S.		REC8M0054726		
496 MAG HO	496/V8	2004-07	OM025000- OW059999	REC881693002		REC862998	REC853678T	REC802630T01	REC861126A1			REC805223T
	496/V8	2001-04	OW060000+	REC881693002		REC862998	REC853678T	N.S.S.		REC8M0054726		REC805223T
496 MAG HO DTS	496/V8	2004-07	OM025000- OW059999	REC881693002				REC802630T01	REC861126A1			REC805223T
	496/V8	2001-04	OW060000+	REC881693002				N.S.S.		REC8M0054726		REC805223T
8.1L MIE	496/V8	2004-07	OM026000- OW059999	REC881693002		REC862998	REC853678T	REC802630T01	REC861126A1			REC805223T
	496/V8	2001-04	OW090000+	REC881693002		REC862998	REC853678T	N.S.S.	REC892681	REC8M0054726		REC805223T
8.1L HO MIE	496/V8	2004-07	OM026000- OW089999	REC881693002		REC862998	REC853678T	REC802630T01	REC861126A1			REC805223T
	496/V8	2001-04	OW090000+	REC881693002		REC862998	REC853678T	N.S.S.	REC892681	REC8M0054726		REC805223T
500 EFI	502/V8	2004-07	OL001477+		REC9-33304	REC3855194		REC849899	REC861126A1	REC3850396	REC8M0077616	
	502/V8	1999-05	OD840650- OK147349		REC9-33303	REC3855194	REC8M0125617	REC805227A1		REC3850396	REC8M0077616	
502 MAG MPI	502/V8	1993-96	OK147350- OL085432		REC9-33303	REC3855194	REC8M0125617	REC805227A1	REC860349A1	REC3850396	REC8M0077616	REC805223T
	502/V8	1997-98	OL085432- OM024999		REC9-33302	REC3855194	REC8M0125617		REC861126A1	REC3850396	REC8M0077616	REC805223T
525 EFI	502/V8	1999-01	OM900146+		REC9-33303		REC8M0125617		REC861126A1	REC854445		
575 SCI	502/V8	2003-07	OL306696- OM950526			REC3855194	REC8M0125617		REC807952A1	REC879150150	REC8M0077616	REC805223T
	502/V8	00-05	OF819620- OK147349		REC9-33303	REC3855194	REC8M0125617	REC805227A1		REC3850396	REC8M0077616	REC805223T
8.2 MPI MIE	502/V8	1996	OK127350- OL086012		REC9-33303	REC3855194	REC8M0125617	REC805227A1	REC860349A1	REC3850396	REC8M0077616	REC805223T
	502/V8	97-98	OL086013- OL674200		REC9-33303	REC3855194	REC8M0125617		REC861126A1	REC3850396	REC8M0077616	REC805223T

MOTORES DE ARRANQUE

STARTERS

MOTORINI AVVIAMENTO DEMARREUR

REF	OEM	⚡	☀️	⚙️	🔧
REC50-8M0095471	50-8M0095471	12V	11 CW	14"	4.5L MPI 2A441953+ 6.2L MPI 2A456613+

REF	OEM
REC10-861788	10-861788



Motor de arranque para sustituir a todos los motores de tamaño pequeño con tornillos fijación en diagonal excepto los 7.4L

Starter to replace all the little engines with diagonally fixation screws excepting 7.4L

Motorino d'avviamento per sostituire tutti i motori V 6 e V 8 con motorini con viti di supporto trasversali eccetto i motori 7.4L

Démarrreur pour remplacer tous les moteurs de petite taille avec des vis de fixation diagonales sauf 7.4L

REF	OEM	⚡	☀️	⚙️	🔧
REC50-863007A1	50-863007A1	12V 1.4 kW	11	14"	REC3859054 4 cyl V6 Et V8 3.0L

REF	OEM
REC10-861788	10-861788



Motor de arranque Heavy Duty. Tornillos de fijación en diagonal.

Starter with diagonally fixation screws.

Motorino d'avviamento Heavy Duty con viti di supporto trasversali.

Démarrreur à usage intensif. Vis de fixation diagonale.

REF	OEM	⚡	☀️	⚙️	🔧
REC3885317	50-864340A2	12V 1.7 kW	11	14"	RECPG260 V6 Et V8 7.4L

REF	OEM
REC10-861788	10-861788



REF	OEM	⚡	☀️	🔧
REC3854190	50-69865A1 50-12782 50-56886	12V	10	REC0987883 FORD 5.0 Et 5.8L



Tornillos de fijación en diagonal.

Starter with diagonally fixation screws.

Viti di supporto trasversali.

Vis de fixation diagonale.

REF	OEM	⚡	☀️	⚙️	🔧
REC50-99418A2	50-864340A2 50-99418A2	12V	9	14 ^{1/4"}	REC3853869 V6 Et V8

REF	OEM
REC10-861788	10-861788



Contrarrotación o montaje en campana. Starter counter clockwise.

Controrotante, posizionato nella campana.

Contre-rotation ou montage sur capot.

REF	OEM	⚡	☀️	🔧
REC50-808011A05	50-808011A05 50-88671A1 50-80811A4	12V 1.4 kW	9	4, 6 Et 8 cyl 5.7 MIE / 6.2 MIE.



Motor de arranque pequeño 4 en línea.

Starter Clockwise for 4L.

Viti di supporto trasversali

Petit moteur de démarrage 4 en ligne.

REF	OEM					
REC50-806965A4	50-863007A1 50-806963A2 50-806965A4	12V 1.4 kW	11	12 ^{3/4"}	REC3859054	V6 & V8



	OEM
MP0180-001	10-812509184
REC10-861788	10-861788



REF	OEM					
REC50-8M0090697	50-812429A2 50-806965A2 50-806965A4 50-8M0090697	12V 1.4 kW	11	12 ^{3/4"}	REC3859054	3.0L



	OEM
MP0180-001	10-812509184
REC10-861788	10-861788



Modelo antiguo. Motor de arranque 4 en línea. Tornillos sujeción misma altura

Old style. Starter heavy duty standard rotation 4 in line. In line mounting holes.

Modello vecchio. Motorino d'avviamento 4 in linea. (Viti di supporto parallele)

Modèle plus ancien. Démarreur 4 en ligne. Vis de fixation de même hauteur.

REF	OEM					
	50-806965A4 50-99417A2	12V	9	REC3853869	V6 & V8	



	OEM
MP0180-001	10-812509184
REC10-861788	10-861788



REF	OEM					
REC3916854	50-805991	12V	10	7.3L BRAVO & MIE DIESEL NAV444 V8 (1994-96) 6.9L		



Motor de arranque 4 en línea modelo 470.

Starter clockwise 4 in line 470 mod. and engines with transmission.

Motorino d'avviamento 4 in linea modello 470.

Moteur de démarrage 4 en ligne modèle 470.

REF	OEM					
REC50-97499A2	50-72550A2 50-47454 50-65785A1 50-79604A3	12V 1.4 kW	9	4, 6 & 8 cyl		



PMGR

REF	OEM					
REC879194371	879194371 882481	12V 1.4 kW	13 CW	CMD 1.7 MI/MS D1.7L DTI		



PMGR

REF	OEM					
REC879172259	879172259 896332191	12V 2.3 kW	9 CW	CMD2.8 CMD QSD 2.8 & 4.2		

ALTERNADORES Y REGULADORES

ALTERNATORS & VOLTAGE REGULATORS

ALTERNATORI E REGOLATORI



ALTERNATEURS ET REGULATEURS

ALTERNADORES

ALTERNATORS



ALTERNATORI

ALTERNATEURS



REF	OEM		 6	
REC898101505	898101505	12V 110A	SERPENTÍN GROOVE PULLEY SERPENTINA SERPENTINE	CMD QSD 2.0/2.8 & 4.2 2.0L EI



new

REF	OEM			REG.	
REC69729	78403A2 59755 69729 56045	12V 61A	SIMPLE SINGLE SINGOLA SIMPLE	AUTOEXCITANTE SELF-EXCITING AUTOECCITANTE AUTO-EXCITANT	CMD QSD 2.0/2.8 & 4.2 2.0L EI





REF	OEM			REG.	
REC78403A2	817119A4 78402 78403A1 78403A32 92497A3	12V 63A	SIMPLE SINGLE SINGOLA SIMPLE	AUTOEXCITANTE SELF-EXCITING AUTOECCITANTE AUTO-EXCITANT	3.0/V6 & V8





REF	OEM		 6 (65 mm)	REG.	
REC862031T1	862031T1 862031 862031T	12V 70A	SERPENTÍN GROOVE PULLEY SERPENTINA SERPENTINE	INTERNO INTERNAL INTERNO INTERNE	4.3 & 5.7L (1997+)





REF	OEM			REG.	
REC3860769	817119A4 98555 12449 19685 817119 817119A1	12V 55A	SIMPLE SINGLE SINGOLA SIMPLE	INTERNO INTERNAL INTERNO INTERNE	4.3 & 5.7L (1998+)





REF	OEM			REG.	
REC805884T	805884T 805884 805447T	12V 65A	SIMPLE SINGLE SINGOLA SIMPLE	INTERNO INTERNAL INTERNO INTERNE	EFI & diesel





REF	OEM			REG.	
REC862030T01	862030T01 862030T	12V 70A	SIMPLE SINGLE SINGOLA SIMPLE	INTERNO INTERNAL INTERNO INTERNE	3.0L (1999+)





REF	OEM			REG.	
REC807653T	807653T 807653	12V 65A	SERPENTÍN GROOVE PULLEY SERPENTINA SERPENTINE	INTERNO INTERNAL INTERNO INTERNE	V6 Et V8 (MANDO)





REF	OEM			REG.	
REC807652T	807652T 807652	12V 55A	SERPENTÍN GROOVE PULLEY SERPENTINA SERPENTINE	INTERNO INTERNAL INTERNO INTERNE	V6 Et V8 (MANDO)





REF	OEM			REG.	
REC863077T	863077T 86307AR01	12V 70A	6 (50 mm) SERPENTÍN GROOVE PULLEY SERPENTINA SERPENTINE	INTERNO INTERNAL INTERNO INTERNE	4.3L, 6.2L Et 5.7L (1995+) 4.5 MPI 8.1 Et 4.2L



REF	OEM			REG.	
REC882571	882571 8M0084523	12V 50A	6 (50 mm) SERPENTÍN GROOVE PULLEY SERPENTINA SERPENTINE	MCM 1.7L DTI. CMD 1.7 MI 120 L/L4 CMD 1.7 MS 120L/L4	



REF	OEM			REG.	
REC8M0064021	834832 834832T2 857006A3	12V 50A	4 SERPENTÍN GROOVE PULLEY SERPENTINA SERPENTINE	RACE STERNDRIVE 500EFI, 575 SCI	





KIT SUSTITUCIÓN ALTERNADOR

ALTERNATOR CONVERSION KIT

KIT SOSTITUZIONE ALTERNATORE

KIT ALTERNATEUR

REF		
REC18-5953	12V 68A	470 (3.7L) 224 (3.7L)



REGULADOR ALTERNADOR

VOLTAGE REGULATOR FOR ALTERNATORS

REGOLATORE ALTERNATORE

REGULATEUR ALTERNATEUR

REF	OEM	
REC42785	42785	MANDO



TRIM

MOTOR TRIM

TRIM ENGINES

MOTORI TRIM

MOTEUR TRIM

Motor Trim completo con soporte inox. Incluye motor, solenoides, fusible y cableado.

Complete bracket assembly with Tilt/Trim motor, solenoids, fuse block and wiring. Stainless steel bracket.

Motore trim completo di supporto in acciaio inox. Include il motore, solenoide, fusibile e cablaggio.

Moteur de réglage complet avec support en acier inoxydable. Comprend le moteur, les solénoïdes, le fusible et le câblage.

REF	OEM	
REC865380A25	414336A6 14336A9 88183A12	(1983+) Quick connect



Motor Trim completo con depósito.



Oilayne Complete for late -MCM.

Motore trim completo con serbatoio.

Moteur trim complet avec réservoir.

REF	OEM	
REC865380A13	865380A13 865380A25 88183A12 14336A8 14336A20	12V



REF	OEM			
REC891736T	891736T 17649 17649T	12V	3	Alpha, II gen Et Bravo



CONVERTIDOR DE 3 A 2 CABLES

3 TO 2 WIRE WIRED CONVERTER

CONVERTITORE CAVI DA 3 A 2 FILI

FAISCEAU CONVERTISSEUR 3 À 2 FILS

REF	OEM
REC84-819514T26	

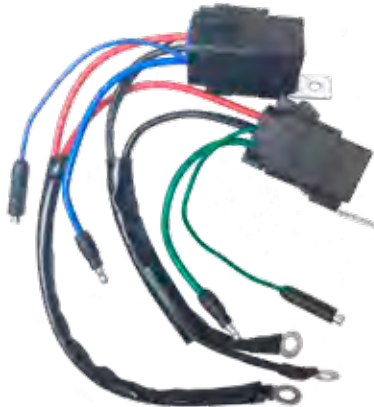

SOPORTE CON PARTES ELECTRICAS

BRACKET ASSY

SUPPORTO TRIM

SUPPORT POMPE DE TRIM AVEC RELAIS

Soporte motor Trim fabricado en acero inox. Incluye solenoides, fusible y cableado.

Bracket assembly with solenoids, fuse block and wiring. Stainless steel bracket.

Supporto motorino Trim in acciaio inox. Include i solenoidi, fusibile e cablaggio.

Le support du moteur de la garniture est en acier inoxydable. Comprend les solénoïdes, le fusible et le câblage.

REF	OEM
REC862548A1	865380A13



REF	OEM
REC42419A1	862548A1 42419A1



VASCHETTA TRIM

RESERVOIR TRIM

DEPÓSITO TRIM

RESERVOIR TRIM

REF	OEM	
REC18525A1	18525A1	1
REC883166A2	883166A2	4



SOLENOIDES , RELÉS Y FUSIBLES

SOLENOID, RELAY & FUSES

SOLENOIDI, RELÉ E FUSIBILE

SOLÉNOÏDE, RELAIS ET FUSIBLES

SOLENOIDES

SOLENOID

SOLENOIDI

SOLÉNOÏDE

REF	OEM	⚡
REC89-818999A2	89-818999A2 89-818999A1 89-805188A1	12V



SOLENOIDE TRIM

TRIM SOLENOID

SOLENOIDI TRIM

SOLÉNOÏDE TRIM

REF	OEM	⚡
REC89-96158T	89-96158T 89-96158	12V
REC852565	89-853654A1 89-68258A4	
REC89-818997A1	89-818997T1 89-818997A1	



REC852565



REC89-818997A1



REC89-96158T

SOLENOIDE ARRANQUE

STARTER SOLENOID

SOLENOIDI AVVIAMENTO

SOLÉNOÏDE DE DEMARREUR

REF	OEM	⚡
REC89-96054T	89-96054T 89-96054 89-91975	12V
REC89-96158T	89-818864T 89-818864	
REC3853839	87-76416A1	
REC378444	25661T1 25661	
REC65057T1	65057T1 65057A1	



REC89-96158T



REC3853839



REC378444



REC65057T1



REC89-96054T

SOLENOIDE DELCO REMY

DELCO REMY SOLENOID

SOLENOIDI DELCO REMY

SOLÉNOÏDE DELCO REMY

REF	OEM	⚡
REC13037	13037 8733261	9.5 cm
REC3853869	89-853654A1 89-18080	7.5 cm
REC3859054	89-99253 809463A1	12V



REC13037
REC3853869



REC3859054

EXTENSOR DE SOLENOIDE PARA TERMINALES

SOLENOID EXTENSOR FOR TERMINALS

PROLUNGA TERMINALE PER SOLENOIDE

EXTENSION POUR SOLÉNOÏDE

REF	OEM
REC855314	



RELÉ	RELAY	RELÉ	RELAIS								
<table border="1"> <thead> <tr> <th>REF</th> <th>OEM</th> <th></th> <th></th> </tr> </thead> <tbody> <tr> <td>REC876037</td> <td>8M0057697 8M0032176</td> <td>4.5L Et 6.2L MPI</td> <td>40/30 A</td> </tr> </tbody> </table>	REF	OEM			REC876037	8M0057697 8M0032176	4.5L Et 6.2L MPI	40/30 A			
REF	OEM										
REC876037	8M0057697 8M0032176	4.5L Et 6.2L MPI	40/30 A								

RELÉ ARRANQUE Y BOMBA GASOLINA	RELAY FOR IGNITION & FUEL PUMP	RELÉ DI AVVIAMENTO, E POMPA BENZINA	RELAIS DE DEMARREUR ET POMPE D'ESSENCE				
<table border="1"> <thead> <tr> <th>REF</th> <th>OEM</th> </tr> </thead> <tbody> <tr> <td>REC86-865202T</td> <td>86-865202T</td> </tr> </tbody> </table>	REF	OEM	REC86-865202T	86-865202T			
REF	OEM						
REC86-865202T	86-865202T						

RELÉ PARA ACELERADOR Y EJE	RELAY FOR THROTTLE AND SHIFT	RELÉ DI ACCELERATORE E ASSE	RELAIS POUR L'ACCELERATION ET L'ARBRE												
<table border="1"> <thead> <tr> <th>REF</th> <th>OEM</th> <th></th> </tr> </thead> <tbody> <tr> <td>REC882751A04</td> <td>882751A04</td> <td>496 MAG (BASE & H.O.) 8.1L INBOARD (BASE & H.O.) 8.1L TOWSPORT</td> </tr> </tbody> </table> <p>Relay para cable mecánico Relay for mechanical wire Relé per cavo meccanico Relais de câble mécanique</p>	REF	OEM		REC882751A04	882751A04	496 MAG (BASE & H.O.) 8.1L INBOARD (BASE & H.O.) 8.1L TOWSPORT		<table border="1"> <thead> <tr> <th>REF</th> <th>OEM</th> <th></th> </tr> </thead> <tbody> <tr> <td>REC3854138</td> <td>882751A1 828151 828151A1 882751A2 882751</td> <td>8.2L INBOARD (BASE & H.O.) EC 8.2L MAG V6 & V8</td> </tr> </tbody> </table> <p>Relay para cable digital y mecánico Relay for digital & mechanical cable Relé per cavo digitale e meccanico Relais pour câble digital et mécanique</p>	REF	OEM		REC3854138	882751A1 828151 828151A1 882751A2 882751	8.2L INBOARD (BASE & H.O.) EC 8.2L MAG V6 & V8	
REF	OEM														
REC882751A04	882751A04	496 MAG (BASE & H.O.) 8.1L INBOARD (BASE & H.O.) 8.1L TOWSPORT													
REF	OEM														
REC3854138	882751A1 828151 828151A1 882751A2 882751	8.2L INBOARD (BASE & H.O.) EC 8.2L MAG V6 & V8													

RELÉ PARA ALARMA Y VARIOS	RELAY FOR ALARM & OTHERS	RELÉ PER ALARMA E ALTRI	RELAIS POUR ALARME ET D'AUTRES						
<table border="1"> <thead> <tr> <th>REF</th> <th>OEM</th> <th></th> </tr> </thead> <tbody> <tr> <td>REC882751A04</td> <td>821509 821509T01</td> <td>CMD 2.8 EI, ES (165) CMD 4.2 EI, ES, MI, MS (200, 230, 250, 300) D2.8L/165 D-TRONIC D3.0L, D3.6L, D4.2L/(200, 220, 250, 300)</td> </tr> </tbody> </table>	REF	OEM		REC882751A04	821509 821509T01	CMD 2.8 EI, ES (165) CMD 4.2 EI, ES, MI, MS (200, 230, 250, 300) D2.8L/165 D-TRONIC D3.0L, D3.6L, D4.2L/(200, 220, 250, 300)			
REF	OEM								
REC882751A04	821509 821509T01	CMD 2.8 EI, ES (165) CMD 4.2 EI, ES, MI, MS (200, 230, 250, 300) D2.8L/165 D-TRONIC D3.0L, D3.6L, D4.2L/(200, 220, 250, 300)							

FUSIBLE MOTOR	CIRCUIT BREAKER	FUSIBILE MOTORE	FUSIBLE MOTEUR												
<table border="1"> <thead> <tr> <th>REF</th> <th>OEM</th> <th></th> </tr> </thead> <tbody> <tr> <td>BS2142</td> <td>88-11178A01</td> <td>50A</td> </tr> <tr> <td>BS2143</td> <td>88-93582</td> <td>60A</td> </tr> <tr> <td>BS2138</td> <td>88-8M2011907</td> <td>15A</td> </tr> </tbody> </table>	REF	OEM		BS2142	88-11178A01	50A	BS2143	88-93582	60A	BS2138	88-8M2011907	15A			
REF	OEM														
BS2142	88-11178A01	50A													
BS2143	88-93582	60A													
BS2138	88-8M2011907	15A													

FUSIBLE MOTOR TRIM	TRIM FUSE ASSY	FUSIBILE MOTORINI TRIM	FUSIBLE MOTEUR TRIM									
<table border="1"> <thead> <tr> <th>REF</th> <th>OEM</th> <th></th> </tr> </thead> <tbody> <tr> <td>REC88-79023T10</td> <td>88-79023T10</td> <td>110A</td> </tr> <tr> <td>RM88-79023A91</td> <td>88-79023A91</td> <td>90A</td> </tr> </tbody> </table>	REF	OEM		REC88-79023T10	88-79023T10	110A	RM88-79023A91	88-79023A91	90A			
REF	OEM											
REC88-79023T10	88-79023T10	110A										
RM88-79023A91	88-79023A91	90A										

FUSIBLE ATM		ATM FUSE	FUSIBLE ATM	FUSIBLE ATM
REF	OEM	⚡	📄	
AM603905	88-832969T05	5 A		
AM603910	88-832969T10	10 A		
AM603915	88-832969T15	15 A	2	
AM603920	88-832969T20	20 A		
AM603930	88-832969T30	30 A		

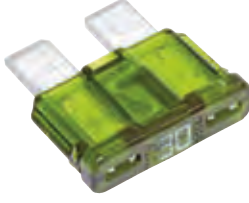
FUSIBLE ATC		ATC FUSE	FUSIBLE ATC	FUSIBLE ATC
REF	OEM	⚡	📄	
BS5291		3 A		
BS5299		4 A		
BS5292	862646	5 A		
BS5293		7,5 A		
BS5294	862647	10 A	2	
BS5295		15 A		
BS5296	88-212619	20 A		
BS5297		25 A		
BS5298		30 A		

FUSIBLE MAXI		MAXI FUSE	FUSIBLE MAXI	FUSIBLE MAXI
REF	OEM	⚡	📄	
BS5138		30 A		
BS5139		40 A		
BS5140	88-79023A94	50 A	2	
BS5141		60 A		
BS5142		70 A		
BS5143		80 A		

FUSIBLE TERMINAL DE BATERIA		BATTERY SWITCH FUSE	FUSIBLE TERMINALE BATERIA	FUSIBLE TERMINAL BATERIE
REF	OEM	⚡	REF	OEM
BS5175	88-8M0129533	30A	BS5191	
BS5177	88-8M0129534	50A		
BS5181	88-8M0129535	80A		
BS5182	88-8M0129560	90A		
BS5183	88-8M0130941	100A		
BS5185	88-8M0129528	150A		
BS5187	88-8M0129530	200A		
BS5189	88-8M0129531	250A		

MERCATHODE		MERCATHODE	MERCATHODE	MERCATHODE
REF	OEM			
REC42600A09	42600A09 42600A5 42600A3 42600A1			

INTERRUPTORES TRIM

POWER TRIM SWITCH ASSY

INTERRUTTORE TRIM

COMMUTATEUR DE TRIM

REF	OEM	⚡
REC87-18286A43	87-18286A43	
REC87-858679T2	87-858679T2	12V
REC87-859032T02	87-859032T02	



REC87-18286A43



REC87-859032T02



REC87-858679T2

new

INTERRUPTORES DE PARO

IGNITION KILL SWITCH

INTERRUTTORE DI STOP

INTERRUPTEUR DE STOP

REF	OEM	⚡
REC87-91941A8	87-91941A8	12V



new

REF	OEM	🔑
REC803623001	803623001	D/CMD 2.8L
	811406	D/CMD 4.2L
	803623	D/CMD 1.7L D254TURBO

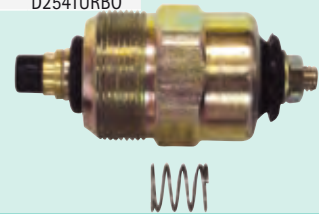

new

REF	OEM
REC87-19674A1	87-19674A1

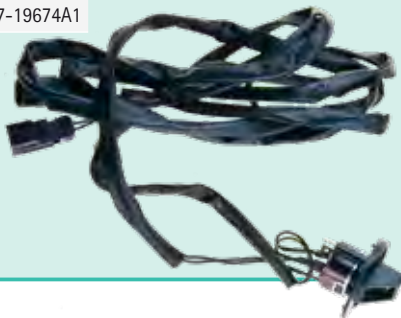

new

REF	OEM
REC8M0092849	8M0092489



new

ALARMA

ALARM ASSY

KIT ALLARME

BUZZER D'ALARME

REF	OEM
REC8M0144930	8M0144930



new

SISTEMA ENCENDIDO IGNITON SYSTEM

SISTEMA DI ACCENSIONE SYSTEME D'ALLUMAGE

BOBINAS	COILS	BOBINE	BOBINES
BOBINA DE ENCENDIDO	IGNITION COIL	BOBINA DI ACCENSIONE	BOBINE D'ALLUMAGE

REF	OEM	
REC300-8M0044991	300-8M0044991 8M0029482	4.5L MPI (3 UN.) 6.2L MPI (4 UN.)

DOBLE SALIDA
TWIN OUT
DOPPIA USCITA
DOUBLE SORTIE



new

REF	OEM	
REC806673T1	806673T1 806673T	V8 (5.0 & 5.7L)



REF	OEM	
REC3854002	898253T27 817378 817378T	4 CIL. (V6 & V8)





REF	OEM	
REC3861267	392-881732	Motores 496 Magnum 8.1 Inboard



REF	OEM	
REC3859078	392-889925	8.1L & 496 Mag (OM315053 +)



REF	OEM	
REC3861985	392-863704T 8M0054588	2001+ 4.3, 5.0, 5.7 & 6.2L EMC OM300000+



ENCENDIDO ELECTRONICO	ELECTRONIC IGNITION	ACCESIONE ELETTRONICA	BOBINE D'ALLUMAGE ELECTRONIQUE
NO USA RESISTENCIA EXTERNA HEI Sistema de encendido Thunderbolt	USE WITHOUT EXTERNAL RESISTOR HEI Thunderbolt ignition system	NON UTILIZZA RESISTENZA ESTERNA HEI Sistema di accensione Thunderbolt	N'UTILISE PAS DE RESISTANCE EXTERNE HEI Système d'allumage Thunderbolt

REF	OEM
REC300-00879	392-805570A2 392-7803A4



USA RESISTENCIA EXTERNA
HEI
DELCO 1115202

USE WITH EXTERNAL RESISTOR
HEI
DELCO 1115202

UTILIZZA RESISTENZA ESTERNA
HEI
DELCO 1115202

UTILISE UNE RÉSISTANCE EXTERNE
HEI
DELCO 1115202

REF	OEM
REC1463-9382	898253T24
	392-806529A1
	32193A2
	38547



MÓDULOS IGNICIÓN

IGNITION MODULES

MODULI AVVIAMENTO

MODULES D'ALLUMAGE

REF	OEM		BOBINA COIL BOBINA BOBINE
REC3858984	GM10482803	4.3, 5.0, 5.7 Et 6.2L MPI ECM555 (2001+) OM300000+	REC3861985



REF	OEM	
REC3854001	811639T	V4, V6, V8 Delco Voyager



REF	OEM	
REC3854003	811637T	4L, V6 Et V8 Delco Voyager
	811637001	
	81637002	
	811637	
	850487	
	804412 802464	



REF
REC004



BUJÍAS SPARK PLUG CANDELE BOUGIES

BUJÍAS SPARK CANDELE BOUGIES

		CYL	SERIE SERIAL SERIE SERIE	REF
110		4, 153 CID		CHARN5C
110		4, 153 CID		CHARV15YC4
140		4, 181 CID	-3826282	CHARN5C
140		4, 181 CID	3826283	CHARV15YC4
3.0		4, 181 CID	-0F353100	CHARV15YC4
3.0		4, 181CID	0L010042+	CHARS12YC
3.0 LX		4, 181 CID		CHARS12YC
470, 165, 170, 485, 488, 180, 190,		4, 224 CID		CHARS12YC
3.7L, 3.7LX,		4, 224 CID		CHARS12YC
140, 150, 160,		4, 224 CID		CHARS12YC
165		6, 194, 230 & 292 CID	-2771483	CHARN5C
165		6, 194, 230 & 292 CID	2771484	CHARV15YC4
200		6, 194, 230 & 292 CID		CHARN5C
185		V6, 229 CID		CHARV15YC4
175, 185, 205		V6, 262 CID		CHARV15YC4
262 MAG EFI GEN+		V6, 262 CID	0F80800-0L000000	CHARS12YC
4.3L MPI		V6, 262 CID		CHARV15YC4
4.3L		V6, 262 CID	-0F802999	CHARV15YC4
4.3LX		V6, 262 CID	0F802999+	CHARV15YC4
4.3 GEN+		V6, 262 CID	0L010065+	CHARS12YC
4.3LL EFI GEN+		V6, 262 CID	0L012009+	CHARS12YC
4.3LH GEN+		V6, 262 CID	0L010044+	CHARS12YC
4.3LX GEN+		V6, 262 CID	0F803000-0L000000	CHARS12YC
4.3LXH GEN+		V6, 262 CID	0F803000-0L000000	CHARS12YC
888 Culata Head Testata Tête : 14mm FORD V8		CHARV15YC4	4169597	CHARV15YC4
233 Culata Head Testata Tête : 14mm FORD V8		FORD V8		CHARV15YC4
255 Culata Head Testata Tête : 14mm FORD V8		CHARV15YC4	4175499	CHARV15YC4
190		V8 283, 327, 305, 350 CID		CHARJ12YC
898, 200		V8 283, 327, 305, 350 CID		CHARV9IMC
225		V8 283, 327, 305, 350 CID	2278647	CHARJ12YC
228, 230		V8 283, 327, 305, 350 CID		CHARV9IMC
250		V8 283, 327, 305, 350 CID	4768000	CHARV15YC4
255		V8 283, 327, 305, 350 CID		CHARV15YC4
260		V8 283, 327, 305, 350 CID		CHARV9IMC
280, 300 Tempest, 320 EFI		V8 283, 327, 305, 350 CID		CHARV15YC4
350 Mag (Carb)		V8 283, 327, 305, 350 CID		CHARV9IMC
350 Mag EFI/MP		V8 283, 327, 305, 350 CID	-0F602199	CHARV9IMC
350 Mag EFI GEN+ V8		CHARS12YC	0F800500+	CHARS12YC
350 Mag MPI GEN+ V8		CHARS12YC	0F602000+	CHARS12YC
350 Mag MPI GEN+ V8		CHARS12PYP	0L604000+	CHARS12PYP
377 Scorpion		V8 283, 327, 305, 350 CID	0L416146+	CHARS12YC
5.0L MPI		V8 283, 327, 305, 350 CID		CHARS12YC
5.0L		V8 283, 327, 305, 350 CID	- 0L000000	CHARV9IMC
5.0L GEN+		V8 283, 327, 305, 350 CID	0L015751	CHARS12YC
5.0L EFI GEN+		V8 283, 327, 305, 350 CID	0L012052	CHARS12YC
5.0LX		V8 283, 327, 305, 350 CID		CHARV9IMC
5.7L		V8 283, 327, 305, 350 CID	-0L000000	CHARV9IMC
5.7L EFI		V8 283, 327, 305, 350 CID	-0L000000	CHARV9IMC
5.7L GEN+		V8 283, 327, 305, 350 CID	0L010037+	CHARS12YC
5.7L EFI GEN+		V8 283, 327, 305, 350 CID	0L010035+	CHARS12YC
5.7LX, 5.7LX EFI		V8 283, 327, 305, 350 CID		CHARV9IMC
5.7LX EFI GEN+		V8 283, 327, 305, 350 CID		CHARS12YC
325		V8 427, 454 & 482 CID	3043030	CHAV63C
330, 330 (B-W), 370, 400, 400 Cyclone		V8 427, 454 & 482 CID		CHARV15YC4
420, HP425, 440 Cyclone, HP450		V8 427, 454 & 482 CID		CHARV15YC4
454 Mag Alpha, Bravo, EFI/MP/MPI		V8 427, 454 & 482 CID		CHARV15YC4
460 Cyclone, 475 Turbo, HP525 SC		V8 427, 454 & 482 CID		CHAV63C
7.4L Alpha, 7.4L Bravo		V8 427, 454 & 482 CID		CHARV15YC4
7.4L TR		V8 427, 454 & 482 CID	0B771113-0C407646	CHARV15YC4
7.4L MPI (L29)		V8 427, 454 & 482 CID	0L010003+	CHARS12YC
7.4LX EFI, 7.4LX MPI		V8 427, 454 & 482 CID		CHARV15YC4
HP465, HP500 (502 CID), HP500 EFI		V8 502, 540 & 572 CID		CHARV15YC4
HP500 Bulldog 540, HP525 SC 454		V8 502, 540 & 572 CID		CHAV63C
HP575, HP600SC Bobtail (502 CID)		V8 502, 540 & 572 CID		CHAV63C
HP800SC (572 CID)		V8 502, 540 & 572 CID		CHAV63C
502 MAG (CARB.), EFI/MA/MPI		V8 502, 540 & 572 CID		CHARV15YC4
600SC, 800SC		V8 502, 540 & 572 CID		CHAV63C



REF
CHAPROSU

MERCUISER | CUMMINS

RECAMBIOS MARINOS



BUJÍAS **SPARK** **CANDELE** **BOUGIES**

	CYL	IGNITION TYPE	year	SERIE	REF	S.P GAP
100 Vazer	98/L4	Delco- HEi	2007-09	1A035000 +	NGKBR9ES	.035
110	153/ L4	Delco	1963-66	1537370 - 2044033	NGKBR6ES	.035
120	153/ L4	Delco	1964-74	1666601 - 3825578	NGKBR6ES	.035
120	153/ L4	Delco	1974-86	3825579 - 0B531853	NGKBR6FS	.035
2.5L	153/ L4	Delco	1987-89	0B531854- 0C853255	NGKBR6FS	.035
140	181/ L4	Delco	1968-74	2508261 - 3826282	NGKBR6ES	.035
140	181/ L4	Delco	1974-86	3826283 - 0B450800	NGKBR6FS	.035
3.0L	181/ L4	Delco	1987-89	0B450801 - 0C856558	NGKBR6FS	.035
3.0L	181/ L4	Prestolite	1990-91	0C856559 - 00504541	NGKBR6FS	.035
3.0L	181/ L4	Delco Digital	1990-91	0C856559 - 00504541	NGKBR6FS	.035
3.0L	181/ L4	EST	1991-94	0D504542 - 0F603999	NGKBPR6EFS	.035
3.0L	181/ L4	EST	1998	0L010042 - 0L340999	NGKBPR6EFS	.035
3.0L	181/ L4	EST	1999-16	0L341000 - 2A506300	NGKBPR6EFS	.045
3.0L MPI	181/ L4	EST	2008-16	1A072812 - 2A502810	NGKBPR6EFS	.045
3.0LX	181/ L4	Prestolite	1990-91	0C856559 - 0D504541	NGKBR6FS	.035
3.0LX	181/ L4	Delco Oigital	1990-91	0C856559 - 0D504541	NGKBPR6EFS	.035
3.0LX	181/ L4	EST	1991-97	0D504542 - 0K999999	NGKBPR6EFS	.035
165	224/ L4	Delco	1987	0B434940 - 0B77451	NGKBPR6FS	.035
170	224/ L4	Delco	1985-86	6916779 - 0B434940	NGKBPR6FS	.035
180	224/ L4	Delco & Prestolite	1987	0B436391 - 0B775248	NGKBPR6FS	.035
190	224/ L4	Delco	1985-86	6916779 - 0B436390	NGKBPR6FS	.035
3.7L	224/ L4	Delco	1988-89	0B774252+	NGKBPR6FS	.035
3.7LX	224/ L4	Delco & Prestolite	1988-89	0B775249+	NGKBPR6FS	.035
470	224/ L4	Delco	1976-84	4208730 - 6916778	NGKBPR6FS	.035
485	224/ L4	Delco	1980-82	5685394 - 6218036	NGKBPR6FS	.035
488	224/ L4	Delco	1983-84	6170297 -6916778	NGKBPR6FS	.035
140	194/ L6	Delco	1963	1538930 - 1725960	NGKBR6ES	.035
150	230/ L6	Delco	1964-66	1666495 - 2048046	NGKBR6ES	.035
160	250/ L6	Delco	1967-69	2048022 - 2770031	NGKBR6ES	.035
165	250/ L6	Delco	1970	2770032 - 2771483	NGKBR6ES	.035
165	250/ L6	Delco	1971-81	2771484 - 5813433	NGKBR6FS	.035
200	292/ L6	Delco	1969	2453769 - 2712072	NGKBR6ES	.035
185 (4 bbl.)	229/ V-6	Prestolite	1983-84	6330183 - 6919655	NGKBR6FS	.035
175	262/ V-6	Thunderbolt IV	1987	0B527955 - 0B773242	NGKBR6FS	.035
185 (2 bbl.)	262/ V-6	Thunderbolt IV	1985-87	6919656 - 0B527954	NGKBR6FS	.035
205	262/ V-6	Thunderbolt IV	1985-87	0A331455-0B775129	NGKBR6FS	.035
262 Mag.(TBI)(Gen+)	262/ V-6	Delco -HEi	1996-97	0F803800 - 0K999999	NGKBPR6EFS	.045
4.3L	262/ V-6	Thunderbolt IV	1988-93	0B773243 - 0F000877	NGKBR6FS	.035
4.3L	262/ V-6	Thunderbolt IV	1993-96	0F000878 - 0F802999	NGKBR6FS	.040
4.3L (Gen +)	262/ V-6	Thunderbolt V	1998-04	0L010044- 0W300012	NGKBPR6EFS	.045
4.3L TKS	262/ V-6	Thunderbolt V	2004-15	0W300013- 2A454127	NGKBPR6EFS	.045
4.3L EFI (Gen+)(TBI)	262/ V-6	Delco & Mercury - HEi	1998-01	0L012009- 0M299999	NGKBPR6EFS	.045
4.3L MPI	262/ V-6	Delco - HEi	2002-16	0M300000 - 2A506375	NGKITR4A15	.060
4.3L MPI EC	262/ V-6	Delco -HEi	2011-16	1A637496 - 2A528897	NGKITR4A15	.060
4.3LH (Gen +)	262/ V-6	Thunderbolt IV	1998-02	0L010044- 0M614999	NGKBPR6EFS	.045
4.3LX	262/ V-6	Thunderbolt IV	1988-93	08775130-0F001219	NGKBR6FS	.035
4.3LX	262/ V-6	Thunderbolt IV	1993-96	0F001220 - 0F802999	NGKBR6FS	.040
4.3LX (Gen +)	262/ V-6	Thunderbolt IV	1996-97	0F803000 - 0K999999	NGKBPR6EFS	.045
4.3LXH (Gen +)	262/ V-6	Thunderbolt IV	1996-97	0F803000 - 0K999999	NGKBPR6EFS	.045
4.5L MPI	275/ V6	Mercury	2014-21	2A441953 and up	NGKBPR5EFS-13	.051
198 MIE	305/ V-8	Mallory	1977	4776402 - 4931099	NGKBR6FS	.035
200	305/ V-8	Thunderbolt IV	1985-87	6899058 - 0B774444	NGKBR6FS	.035
228	305/ V-8	Mallory	1977-82	4765100- 6218461	NGKBR6FS	.035
228	305/ V-8	Thunderbolt IV	1983-84	6218462 - 6899268	NGKBR6FS	.035
228 MIE	305/ V-8	Mallory	1977-80	4765100- 5907057	NGKBR6FS	.035
230	305/ V-8	Thunderbolt IV	1985-87	6899269 - 0B773739	NGKBR6FS	.035
230 MIE (LH)	305/ V-8	Thunderbolt IV	1981-87	5907058 - 0B788151	NGKBR6FS	.035
230 MIE (RH)	305/ V-8	Thunderbolt IV	1981-87	5907058 - 0B788151	NGKBR6FS	.035
5.0L	305/ V-8	Thunderbolt IV	1988-95	0B774445 - 0F600999	NGKBR6FS	.035
5.0L (Gen+)	305/ V-8	Thunderbolt V	1998-04	0L015751 - 0W300009	NGKBPR6EFS	.045
5.0L TKS	305/ V-8	Thunderbolt V	2004-10	0W300010-1A607561	NGKBPR6EFS	.060
5.0L EFI (Gen +)	305/ V-8	Delco & Mercury- HEi	1998-01	0L012052 - 0M299999	NGKBPR6EFS	.045

	CYL	IGNITION TYPE	year	SERIE	REF	S.P GAP
5.0L MIE (LH)	305/ V-8	Thunderbolt IV	1988	0B788152 - 0C396832	NGKBR6FS	.035
5.0L MIE (RH)	305/ V-8	Thunderbolt IV	1988	0B788152 - 0C396832	NGKBR6FS	.035
5.0L MPI	305/ V-8	Delco-HEI	2002-14	0M300000 - 2A445009	NGKITR4A15	.060
5.0L MPI EC	305/ V-8	Delco-HEI	2008-14	1A300000 - 2A444777	NGKITR4A15	.060
5.0LX	305/ V-8	Thunderbolt IV	1988-95	0B773740 - 0F600999	NGKBR6FS	.035
898	305/ V-8	Mallory	1977-82	4762210 - 6218461	NGKBR6FS	.035
898	305/ V-8	Thunderbolt IV	1983-84	6218462 - 6899057	NGKBR6FS	.035
250	350/ V-8	Mallory	1977	4768000 - 4908849	NGKBR6FS	.035
255 MCM & MIE (GM)	350/ V-8	Mallory & Mercury	1975-76	3258728 - 4767999	NGKBR6FS	.035
260	350/ V-8	Mallory	1978-82	4908850 - 6218461	NGKBR6FS	.035
260	350/ V-8	Thunderbolt IV	1982-87	6218462 - 0B773304	NGKBR6FS	.035
260 MIE (LH)	350/ V-8	Thunderbolt IV	1981-87	5907058 - 0B788151	NGKBR6FS	.035
260 MIE (RH)	350/ V-8	Thunderbolt IV	1981-87	5907058 - 0B788151	NGKBR6FS	.035
280 TRS	350/ V-8	Mercury	1975	4176250 - 4499390	NGKBR6FS	.035
280 TRS	350/ V-8	Mallory	1976	4499391 - 4770199	NGKBR6FS	.035
300	350/ V-8	Thunderbolt IV	1985-86	6668677 - 0B430367	NGKBR6FS	.035
320 EFI	350/ V-8	Thunderbolt IV	1987-89	0A543604-0C622418	NGKBR6FS	.035
350 Mag. Alpha	350/ V-8	Thunderbolt IV & V	1986-97	0A635178 - 0K999999	NGKBR6FS	.035
350 Mag. Alpha EFI (Gen+)	350/ V-8	Delco-HEI	1996	0K001509-0K999999	NGKBPR6EFS	.045
350 Mag. Bravo MPI	350/ V-8	Delco-HEI	1995	0F415189 - 0F601999	NGKBR6FS	.035
350 Mag. Bravo MPI (Gen+)	350/ V-8	Delco- HEI	1996-97	0F602000 - 0K999999	NGKBPR6EFS	.045
350 Mag. EFI Ski	350/ V-8	Delco- HEI	1994-97	0F215561-0K999999	NGKBPR6EFS	.045
350 Mag. MPI (Gen+)	350/ V-8	Delco- HEI	1998	0L010019 - 0L325952	NGKBPR6EFS	.045
350 Mag. MPI (Gen+)	350/ V-8	Mercury-HEI	1999-01	0L325953 - 0M299999	NGKBPR6EFS	.045
350 Mag. MPI	350/ V-8	Delco-HEI	2002-5	0M300000 - 2A455872	NGKITR4A15	.060
350 Mag. MPI EC	350/ V-8	Delco-HEI	2008-15	1A300000 - 2A455878	NGKITR4A15	.060
350 Mag. MPI Horizon	350/ V-8	Delco-HEI	2002-07	0M300000 +	NGKITR4A15	.060
350 Mag. MPI Horizon MIE	350/ V-8	Mercury-HEI	1999-01	0L304700 - 0M299999	NGKTR5IX	.045
350 Mag. MPI Horizon MIE	350/ V-8	Delco- HEI	2002-07	0M300000 - 1A089999	NGKITR4A15	.060
350 Mag. MPI MIE (Gen+)	350/ V-8	Delco- HEI	1998	0L002008 - 0L302199	NGKBPR6EFS	.045
350 Mag. MPI MIE (Gen+)	350/ V-8	Mercury-HEI	1998-01	0L302200 - 0M299999	NGKBPR6EFS	.045
350 Mag. MPI MIE	350/ V-8	Delco-HEI	2002-07	0M300000 - 1A089999	NGKITR4A15	.060
350 Mag. MPI Ski	350/ V-8	Delco-HEI	1995-96	0F350583 - 0F799999	NGKBR6FS	.035
350 Mag. MPI Ski (Gen+)	350/ V-8	Delco-HEI	1998	0L002600 - 0L304599	NGKBPR6EFS	.045
350 Mag. MPI Ski (Gen+)	350/ V-8	Mercury-HEI	1999-01	0L304600 - 0M299999	NGKBPR6EFS	.045
350 Mag. MPI Ski	350/ V-8	Delco-HEI	2002-07	0M300000 - 1A089999	NGKITR4A15	.060
350 Mag. Ski	350/ V-8	Thunderbolt IV& V	1991-97	0D505450 - 0K999999	NGKBR6FS	.035
5.7L	350/ V-8	Thunderbolt IV& V	1988-97	0B773305 - 0K999999	NGKBR6FS	.035
5.7L (Gen+)	350/ V-8	Thunderbolt V	1998-04	0L010037 - 0W300754	NGKBPR6EFS	.045
5.7L TKS	350/ V-8	Thunderbolt V	2004-09	0W300755-1A600136	NGKBPR6EFS	.060
5.7L EFI	350/ V-8	Delco-HEI	1995-97	0F225560 - 0K999999	NGKBR6FS	.035
5.7L EFI (Gen +)	350/ V-8	Delco & Mercury - HEI	1998-01	0L010035 - 0M299999	NGKBPR6EFS	.045
5.7L EFI MIE (Gen+)	350/ V-8	Delco- HEI	1997	0K040300 - 0K999999	NGKBPR6EFS	.045
5.7L MIE (LH)	350/ V-8	Thunderbolt IV	1988-93	0B788152 - 0F024999	NGKBR6FS	.035
5.7L MIE (RH)	350/ V-8	Thunderbolt IV	1988-93	0B788152 - 0F024999	NGKBR6FS	.035
5.7L MIE	350/ V-8	Thunderbolt IV	1993-95	0F025000 - 0K999999	NGKBR6FS	.035
5.7L MIE (Gen+)	350/ V-8	Thunderbolt V	1998-04	0L002003 - 0W090899	NGKBPR6EFS	.045
5.7L MIE TKS	350/ V-8	Thunderbolt V	2004-10	0W090900 - 1A092388	NGKBPR6EFS	.060
5.7L MPI Horizon MIE	350/ V-8	Delco-HEI	2008-15	1A090000- 2A455371	NGKITR4A15	.060
5.7L MPI MIE	350/ V-8	Delco-HEI	2008-15	1A090000 - 2A455523	NGKITR4A15	.060
5.7L MPI MIE EC	350/ V-8	Delco-HEI	2008-16	1A090000- 2A455371	NGKITR4A15	.060
5.7L MPI Tow Sports	350/ V-8	Delco-HEI	2008-16	1A090000 - 2A455977	NGKITR4A15	.060
5.7L MPI Tow Sports EC	350/ V-8	Delco-HEI	2008-15	1A090000 - 2A452508	NGKITR4A15	.060
5.7LSki	350/ V-8	Prestolite & Mallory	1985-95	0A338553-0F775199	NGKBR6FS	.035
5.7LSki	350/ V-8	Thunderbolt IV& V	1987-97	0B514627 - 0K999999	NGKBR6FS	.035
5.7LSki	350/ V-8	Thunderbolt V	1998-04	0L002005 - 0W090899	NGKBPR6EFS	.045
5.7L Ski TKS	350/ V-8	Thunderbolt V	2004-11	0W090900 - 1A092837	NGKBPR6EFS	.060
5.7LX	350/ V-8	Thunderbolt V	1996-97	0F601000 - 0K999999	NGKBR6FS	.035
5.7LX Bravo EFI (Gen +)	350/ V-8	Delco-HEI	1996-97	0F800300 - 0K999999	NGKBPR6EFS	.045
5.7LX EFI	350/ V-8	Delco- HEI	1996-97	0F752400 - 0K999999	NGKBR6FS	.035
Black Scorpion Ski (Gen+)	350/ V-8	Delco-HEI	1996-02	0F800000 - 0M391599	NGKBPR6EFS	.045
Black Scorpion Ski (Gen+)	350/ V-8	Delco-HEI	2003-07	0M391600 - 0W698432	NGKITR4A15	.060
Scorpion 350	350/ V-8	Delco- HEI	2008-15	0W698433 - 2A460164	NGKITR4A15	.060
Scorpion 350 EC	350/ V-8	Delco- HEI	2008-15	0W698433 - 2A460148	NGKITR4A15	.060

	CYL	IGNITION TYPE	year	SERIE	REF	S.P GAP
377 Mag	377/ V-8	Delco-HEI	2008-15	1A300000 - 2A455858	NGKITR4A15	.060
377 Mag EC	377/ V-8	Delco-HEI	2008-15	1A300000 - 2A455601	NGKITR4A15	.060
377 Scorpion MCM	377/ V-8	Delco- HEi	1999-05	0L416146 - 0M907201	NGKBPR6EFS	.045
377 Scorpion Ski	377/ V-8	Delco -HEi	1997-98	0K000656 - 0L600314	NGKBPR6EFS	.045
6.2L MPI (Mercury)	377/ V-8	Mercury	2015-21	2A456613 +	NGKBPR5EFS-13	.051
MX 6.2L MPI	377/ V-8	Mercury-HEI	2000-01	0L680003 - 0M299999	NGKBPR6EFS	.045
MX 6.2L MPI	377/ V-8	Delco -HEi	2002-07	0M300000 - 1A299999	NGKITR4A15	.060
MX 6.2L MPI Horizon	377/ V-8	Delco -HEi	2002-07	0M300000 +	NGKITR4A15	.060
MX 6.2L MPI Horizon MIE	377/ V-8	Delco -HEi	2002-15	0M300000 - 2A452368	NGKITR4A15	.060
MX 6.2L MPI MIE	377/ V-8	Mercury-HEI	1999-01	0L670000 - 0M299999	NGKBPR6EFS	.045
MX 6.2L MPI MIE	377/ V-8	Delco -HEi	2002-07	0M300000 +	NGKITR4A15	.060
6.2L MPI MIE EC	377/ V-8	Delco -HEi	2008-15	1A090000 - 2A455246	NGKITR4A15	.060
MX 6.2L MPI Ski	377/ V-8	Delco -HEi	2002-07	0M317000 - 0W689999	NGKITR4A15	.060
MX 6.2L Blk Scorpion Ski	377/ V-8	Delco -HEi	2001-02	0L670015- 0M391599	NGKBPR6EFS	.045
MX 6.2L Blk Scorpion Ski	377/ V-8	Delco -HEi	2003-07	0M391750 - 0W698432	NGKITR4A15	.060
Scorpion 377	377/ V8	Delco -HEi	2008-15	0W698433 - 2A460138	NGKITR4A15	.060
Scorpion 377 HO EC	377/ V-8	Delco-HEI	2009-10	1A091488-1A092170	NGKITR4A15	.060
330 MCM&t MIE	454/ V-8	Malklry	1977-81	4623115-6083144	NGKBR6FS	.035
330	454/ V-8	Thunderbolt IV	1982-87	6083145- 0B816540	NGKBR6FS	.035
340 MIE	454/ V-8	Thunderbolt IV	1981-87	5889914 - 0B788365	NGKBR6FS	.035
370 TRS	454/ V-8	Halley	1978-85	4883520 - 6721527	NGKBR6FS	.035
370 TRS	454/ V-8	Thunderbolt IV	1985-87	6721528 - 0B714586	NGKBR6FS	.035
400 TRS	454/ V-8	Halley	1980-86	5668232 - 0B457644	NGKBR6FS	.035
420	454/ V-8	Thunderbolt IV	1987-89	0A398941 - 0B622418	NGKBR6FS	.035
425	454/ V-8	Thunderbolt IV	1990-93	0B622419- 0D937011	NGKBR6FS	.035
440 TRS	454/ V-8	Halley	1983-86	6181070- 0B485220	NGKBR6FS	.035
450	454/ V-8	Thunderbolt IV	1995-96	0F347100- 0F347277	NGKBR6FS	.035
454 Mag. Alpha	454/ V-8	Thunderbolt IV	1986-88	0A631894- 0B785148	NGKBR6FS	.035
454 Mag. Bravo	454/ V-8	Thunderbolt IV	1988-97	0B721206- 0K999999	NGKBR6FS	.035
454 Mag. EFI	454/ V-8	Delco- HEi	1994-96	0F115700 - 0F802349	NGKBR6FS	.035
454 Mag. EFI Ski	454/ V-8	Delco- HEi	1995-96	0F215800 - 0F820099	NGKBR6FS	.035
454 Mag. MPI	454/ V-8	Delco- HEi	1996-01	0F802350 - 0M024999	NGKBR6FS	.040
454 Mag. MPI Horizon MIE	454/ V-8	Delco- HEi	1998-01	0L002200 - 0L674000	NGKBR6FS	.040
454 Mag. MPI Ski	454/ V-8	Delco- HEi	1996-97	0F820100 - 0K999999	NGKBR6FS	.040
525 SC	454/ V-8	Thunderbolt IV	1991-99	0D456000- 0L415623	NGKBR6FS	.035
7.4L Bravo	454/ V-8	Thunderbolt IV	1988-97	0B771113- 0K999999	NGKBR6FS	.035
7.4L EFI MIE	454/ V-8	Delco- HEi	1996-97	0F874815 - 0K999999	NGKBR6FS	.035
7.4L MIE	454/ V-8	Thunderbolt IV & V	1981-97	5889914 - 0K999999	NGKBR6FS	.035
7.4L MPI (L29)	454/ V-8	Delco- HEi	1998-01	0L010003 - 0M024330	NGKBPR6EFS	.045
7.4L MPI MIE	454/ V-8	Delco-HEI	1995-97	0F563052 - 0K999999	NGKBR6FS	.035
7.4L MPI MIE (L29)	454/ V-8	Delco- HEi	1998-01	0L002006 - 0L674613	NGKBPR6EFS	.045
7.4LX Bravo EFI	454/ V-8	Delco- HEi	1996-97	0F820000 - 0K999999	NGKBR6FS	.035
7.4LX Bravo MPI	454/ V-8	Delco-HEI	1996-97	0F602010 - 0K999999	NGKBR6FS	.035
496 Mag &t HO EC	496/ V-8	Delco	2001-10	0M025000 - 1A352731	NGKPZTR5A-15	.060
496 Mag &t HO EC	496/ V-8	Delco	2008-10	1A066166 - 1A350440	NGKPZTR5A-15	.060
8.1S&t HO MIE	496/ V-8	Delco	2001-10	0M026000 - 1A380318	NGKPZTR5A-15	.060
8.1S&t HO MIE EC	496/ V-8	Delco	2008-10	0W697154-1A380251	NGKPZTR5A-15	.060
500	502/ V-8	Thunderbolt IV	1994-98	0F213293-0L001772	NGKBR6FS	.035
500 (Gen+)	502/ V-8	Thunderbolt IV	1999	0L414639 - 0L601036	NGKBR6FS	.035
500 EFI	502/ V-8	Delco- HEi	1998-05	0L001477 +	NGKBR6FS	.035
502 Mag.	502/ V-8	Thunderbolt IV	1990-93	0C878221 - 0F114528	NGKBR6FS	.035
502 Mag. EFI	502/ V-8	Delco-HEI	1993-96	0D840650 - 0F802599	NGKBR6FS	.035
502 Mag. MPI	502/ V-8	Delco- HEi	1996-01	0F802600 - 0M024999	NGKBR6FS	.040
525 EFI	502/ V-8	Mercury- HEi	2003-21	0M900146 +	NGKBPR6ES	.035
600 SC	502/ V-8	Thunderbolt IV	1991-93	0D456489 - 0D763875	NGKBR6FS	.035
8.2L Mag	502/ V-8	Mercury- HEi	2010-21	1A351597 +	NGKBPR6ES	.060
8.2L Mag EC	502/ V-8	Mercury- HEi	2010-21	1A350340 +	NGKBPR6ES	.060
8.2L MIE	502/ V-8	Thunderbolt IV &t V	1990-96	0C878221 - 0F819629	NGKBR6FS	.035
8.2L MIE	502/ V-8	Mercury - HEI	2010-21	1A350802+	NGKBPR6ES	.060
8.2L MIE EC	502/ V-8	Mercury - HEI	2010-21	1A350802 +	NGKBPR6ES	.060
8.L MPI MIE	502/ V-8	Delco- HEi	1996-01	0F819620 - 0L674200	NGKBR6FS	.040
500 Bulldog	540/ V-8	Thunderbolt IV	1990-96	0C577003 - 0F745405	NGKBR6FS	.035
500 Bulldog	540/ V-8	Thunderbolt IV	1997-01	0K000248 - 0M050281	NGKBR6FS	.040



JUEGOS DE CABLES, ALTO RENDIMIENTO

Núcleo del cable de Kevlar de 8 mm antimagnético. Funda de silicona amarilla. Terminales bujías con muelle de acero inox. Terminal del distribuidor de cobre. Terminales bobina. Silicona resistente a altas temperaturas. Garantía de 5 años.

HD SPARK PLUG WIRE SET

Antimagnetic Kevlar core. Yellow silicone boot Et jacket. SS snaplock. Brass distributor terminal. Coil terminals. High resistant silicone. 5 year warranty.

KIT CAVI CANDELE, ALTE PRESTAZIONI

Nucleo del cavo di Kevlar da 8 mm antimagnetico. Copertura di silicone gialla. Terminali candele con molle di acciaio inox. Terminale lato spinterogeno in rame. Terminale Bobine. Silicone resistente alle alte temperature. Garanzia di 5 anni.

KIT FAISCEAU DE BOUGIE

Noyau en Kevlar antimagnétique. Gaine en silicone jaune. Bornes de bougie d'allumage avec ressort en acier inoxydable. Terminal de distribution en laiton. Bornes de bobine. Silicone haute résistance. Garantie de 5 ans.

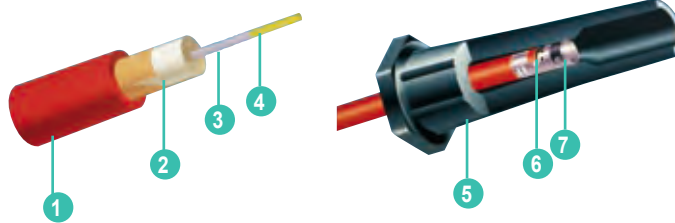

1	Camisa de silicona de 8 mm	8 mm silicone jacket	Rivestimento in silicone da 8 mm	Gaine silicone de 8mm
2	Látex resistente altas temperaturas	Heat resistant latex	Latex resistente alle alte temperature	Latex résistant à haute température
3	Acero inox	Stainless Steel	Acciaio inox	Acier inox
4	Núcleo de Kevlar	Kevlar core	Nucleo de Kevlar	Noyau de Kevlar
5	Capuchón de silicona	Silicone jacket	Rivestimento in silicone	Capuchon en silicone
6	Trenzado especial fibra de vidrio	Fiberglass braiding	Fibra di vetro	Tresse en fibre de verre
7	Terminal de acero inox	Stainless Steel terminal	Terminale di acciaio inox	Terminal en acier inox

Cyl	ARRANQUE		REF	OEM
	IGNITION	AVVIAMENTO		
CONVEN.	ELECT.	DEMARRAGE		
110/120/2.5L 140/3.0L	4	✓	REC15-401	84-813720A5
120/2.5L 140/3.0L 3.0LX	4	✓	REC15-405	84-813720A13
140-185(EN LINEA 6)	6	✓	MAG15-602	84-813720A8 84-816761Q8
165-180 LX/470- 485 190 (3.7L)	4	✓	REC15-402	84-813720A5
175/185 (228, 262) 4.3L (GENI)	6	✓	REC15-601	84-813720A11
185 (229)	6	✓	REC15-604	84-813720A7 84-816761Q7
180 (GM)	8	✓	REC15-801	84-813720A8 84-813720A10 84-813720A4
200/5.0L (GM)	8	✓	REC15-804	84-818781A4 84-8167681A17 84-813720A3
4.3L 2002 + MPI	6	✓	REC15-606	84-813720A8
215-225S 223FORD 225-228GM	8	✓	REC15-801	84-813720A10 84-813720A4 84-816761A4 84-816878A17
228-230/5.0L LX (GM)	8	✓	REC15-804	84-813720A3 84-813720A8 84-813720A10
255 (FORD) 250-225- 225-280(GM)	8	✓	REC15-801	84-813720A10
5.0L GENE+ 2002+ MPI	8	✓	REC15-815	84-816608A1 84-813720A2 84-816781A4 84-816761A17 84-813720A3
350 (5.7L) MAG., SKI	8	✓	REC15-804	84-816608A1
5.7L GENE+ 2002+ MPI	8	✓	REC15-815	84-816608A1
270/280/350 (GM)	8	✓	REC15-801	84-813720A8 84-813720A10 84-816761A2
300MR/TRS (GM)	8	✓	REC15-804	84-816781A15 84-816761A6 84-816761A15 84-813720A4
260/320/325 /330/340 (GM)	8	✓	REC15-804	84-816781A4 84-816761A17 84-813720A3 84-813720A8 84-813720A10 84-816761A2
370/380/400/ 440/460 TRS	8	✓	REC15-801	84-816781A15 84-816761A8 84-816761A15 84-816761A2
420/425/486 /525/575	8	✓	REC15-804	84-816781A15 84-816761A8 84-816761A15
454/500/502 MAG BRAVO	8	✓	REC15-804	84-816781A15 84-816761A8 84-816761A15

Cyl	ARRANQUE		REF	OEM
	IGNITION	AVVIAMENTO		
CONVEN.	ELECT.	DEMARRAGE		
888 (FORD) 898,198 (GM)	8	✓	REC15-801	84-813720A8 84-813720A10 84-816761A2
888 (GM) 5.7 BRAVO	8	✓	REC15-804	84-816781A15 84-816761A8 84-816761A15 84-813720A9
5.7 SKI	8	✓	REC15-801	84-813720A10 84-816761A2
7.4L BRAVO	8	✓	REC15-804	84-816781A15 84-816761A8 84-816761A15 84-816761A2
7.4L 8.2L CON HURTH	8	✓	REC15-804	84-816781A15 84-816761A8 84-816761A15 84-816761A2
300 MR/TRS (GM)	8	✓	REC15-804	84-816781A15 84-816761A6 84-816761A15 84-816761A2
330-340 (GM)	8	✓	REC15-804	84-816781A15 84-816761A6 84-816761A15 84-816761A2
454 MAG BRAVO 420/425/465 /525/575	8	✓	REC15-804	84-816781A15 84-816761A6 84-816761A15 84-816761A2
898 (GM) 5.7 BRAVO	8	✓	REC15-804	84-816781A15 84-816761A6 84-816761A15 84-816761A2
500/502 BRAVO	8	✓	REC15-804	84-816781A15 84-816761A6 84-816761A15 84-816761A2
500/502 BRAVO	8	✓	MAG15-803	84-816781A15 84-816761A6 84-816761A15 84-816761A2
7.4L BRAVO 7.4L-8.2L CON HURTH	8	✓	REC15-804	84-816781A15 84-816761A6 84-816761A15 84-816761A2
7.4L BRAVO 7.4L-8.2L CON HURTH	8	✓	REC15-804	84-816781A15 84-816761A6 84-816761A15
6.2L MPI MIE	8	✓	REC15-813	84-863656A1
454 MAGNUM	8	✓	MAG15-809	
8.1L 496	8	✓	REC15-808	

DISTRIBUIDOR

DISTRIBUTOR

SPINTEROGENO

ALLUMEUR

TAPA DISTRIBUIDOR

DISTRIBUTOR CAPS

CALOTTE SPINTEROGENO

TÊTE D'ALLUMEUR

REF	OEM	
REC33708	33708	Delco V8



REF	OEM	
REC393-4988	393-4988 393-3230 393-4988T 393-4988T2	Autolite 8 Cyl



REF	OEM	
REC33765T	33765T 33765	Delco 6 Cil



REF	OEM	
REC805759Q01	805759Q01 805759A2 805759A1 90746A1 805759A5 805759T2 805759T1 16457A4 805759T2 43557A1 43557	Merc. V8



REF	OEM	
REC982209	391-5075 391-5075Q1 F16900148	Mallory V8

Tapa alta
High cap
Calotta alta
Couvercle haute



REF	OEM	
REC815407A2	815407A2 13753A2 815407Q02	Merc. V6



REF	OEM	
REC392-9086T	392-9086 392-9086T	Prestolite V6



REF	OEM	
REC985218	(1987-90) Ford 2.3L Mallory	



REF	OEM	
REC835702	392-6318 392-6318T F16900184	Prestolite V8

Con clip
with clip
con clip
Avec clip



REF	OEM		ROTOR ROTOR ROTORE DOIGT D'ALLUMEUR
REC3854331	850484T2 850484T 850484	Delco V6 E. elect.	REC3854311



REF	OEM	
REC392-9766	392-9766 392-9766Q1 392-9766T F16900185	Prestolite V8

Con tornillo
with nut
con chiusura a vite
Avec vis



REF	OEM		ROTOR ROTOR ROTORE DOIGT D'ALLUMEUR
REC3854260	811635T3	Delco 4 cil 3.0LX	REC3854261



REF	OEM		ROTOR ROTOR ROTORE DOIGT D'ALLUMEUR
REC3854548	808483T3 808483 804483T 804418	Delco V8 E. elect.	REC3854549



REF	OEM	
REC393-9459Q1	393-9459Q1 393-3230 393-4988T 393-4988T2	Delco 4 Cil



REF	OEM		ROTOR ROTOR ROTORE DOIGT D'ALLUMEUR
REC898253T23	888731 898253T23	4.3L Vortec V6 MPI	REC898253013



REF	OEM		ROTOR ROTOR ROTORE DOIGT D'ALLUMEUR
REC898253T22	884792 898253T22	Vortec V8 MPI Modernos Late Moderna Modernes	REC898253013





ROTORES	ROTORS	ROTORI	DOIGT D'ALLUMEUR
---------	--------	--------	------------------

REF	OEM		
REC898253013	898253013 884790 8M6001222	Vortec V6 & V8 MPI	

REF	OEM		
REC58217	58217 898253008 58217Q 8M6001251	Delco 4 & 6 Cil	

REF	OEM		
REC8M6001252	898253009 8M6001252	GM V8 HEI 1998+	

REF	OEM		
REC89825302	391-5088 391-7057 898253029 391-7057T 8M6001224 FI6901224	Mallory V8	

REF	OEM		
REC65864	65864 78016	Autolite V8 Mercury	

REF	OEM		
REC834975	392-6326 392-6326T FI6900044	Prestolite V8	

REF	OEM		
REC3853801	392-9089 392-9767 392-9089T 392-9089Q FI6900186 FI6900190	Presolite V6 & V8	

REF	OEM		
REC3854311	850485 8504851 898253012 8M0062084 804424	Delco V6	













REF	OEM		
REC3854549	8M6001253 808484 8084841 898253010	Delco V8 E. eléc.	











REF	OEM		
REC3854261	811636 8M6001254 8116361 898253011	Delco 4 cil. 3.0LX	

TRIGGERS (ROTOR + SENSOR)	TRIGGERS (ROTOR + SENSOR WHEEL)	TRIGGER (ROTORE + SENSORE)	KIT DOIGT D'ALLUMAGE
------------------------------	------------------------------------	-------------------------------	----------------------

REF	OEM		
REC13524A6	13524A6 13524Q06 13524A4 19405A4 90576A4	Merc. V6	

REF	OEM		
REC13524A1	13524A1 13524T1 13524A5	Merc. V8	

PLATINOS		POINTS	PUNTINE	VIS PLATINEES			
REF	OEM		REF	OEM			
REC8M6001219	392-898253005 392-6325 8M6001219 FI6900031	Prestolite	REC33700	33700	Delco		
REF	OEM		REF	OEM			
REC34235T	34235 34235T	Delco	REC58033	58033 898253007	Autolite		
REF	OEM		REF	OEM			
REC391-5090	391-5090 391-898253004 8M6001250	Mallory	REC71831	87-71831 64850	Mercury		

CONDENSADORES		CONDENSERS	CONDENSATORI	CONDENSATEUR			
REF	OEM		REF	OEM			
REC8M6001249	392-6324 392-898223002 8M6001249 FI6900023 FI6900032 FI6900083 FI6900189	Prestolite V8	REC8M6001217	391-5092 391-898253001 391-5093 8M6001217 FI6900040	Mallory V8, Delco 4 Et 6 Cil.		
REF	OEM		REF	OEM			
REC33662	33662 898253003 6325 898253005 33662Q 8M6001218 FI6900031	Delco 4 & 6 Cil.	REC33706	33706	Delco V-8		
REF	OEM						
REC64851	81-64851 58034	Autolite					

KITS DE ENCENDIDO		TUNE UP KITS	KIT D'ACCENSIONE	KITS D'ALLUMAGE			
REF	OEM		REF	OEM			
REC3423A1	34235A1 34235Q1	Delco 4 & 6 cil.	REC391-5090Q1	391-5090A1 391-5090Q1	Mallory V8		

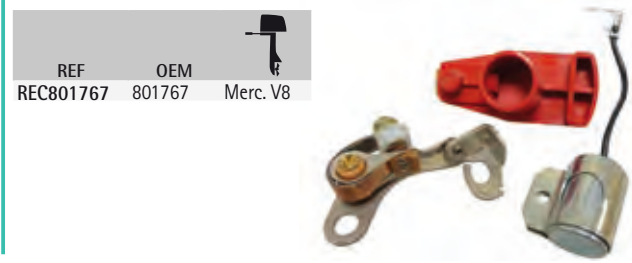

GUÍA KITS DE ENCENDIDO IGNITION APPLICATION GUIDA KIT ACCENSIONE GUIDE KITS D'ALLUMAGE

MOD.	CYL	AÑO YEAR ANNO ANNEE	SERIE SERIAL SERIE SERIE	ARRANQUE IGNITION ACCENSIONE ALLUMAGE	KIT	PLATINO POINT PUNTINE VIS PLATINÉES	CONDENSADOR CONDENSER CONDENSATORE CONDENSATEURS	ROTOR ROTOR ROTORE DOIGT D'ALLUM.
L4								
110	L-4	1963-66	1537370-2044033	Delco	REC3423A1	REC34235T	REC33662	REC1396-5238
120	L-4	1964-74	1666601-3825578	Delco	REC3423A1	REC34235T	REC33662	REC1396-5238
120/2.5L	L-4	1974-89	3825579-0C853255	Delco	REC3423A1	REC34235T	REC33662	REC1396-5238
140	L-4	1968-74	2508261-3826282	Delco	REC3423A1	REC34235T	REC33662	REC1396-5238
140/3.0L	L-4	1974-89	3826283-0C856558	Delco	REC3423A1	REC34235T	REC33662	REC1396-5238
3.0L/LX	L-4	1990-95	0C856559-0F603999	Prestolite	REC392-6324Q1	REC8M6001219	REC8M6001249	REC3853801
165/3.7L	L-4	1987-89	0B434940+	Delco	REC3423A1	REC34235T	REC33662	REC1396-5238
170	L-4	1985-86	6916779-0B434940	Delco	REC3423A1	REC34235T	REC33662	REC1396-5238
180/3.7LX	L-4	1987-89	0B436391+	Delco	REC3423A1	REC34235T	REC33662	REC1396-5238
180/3.7LX	L-4	1987-89	0B436391+	Prestolite	REC392-6324Q1	REC8M6001219	REC8M6001249	REC3853801
190	L-4	1985-86	6916779-0B436390	Delco	REC3423A1	REC34235T	REC33662	REC1396-5238
470	L-4	1976-84	4208730-691778	Delco	REC3423A1	REC34235T	REC33662	REC1396-5238
485	L-4	1980-82	5685394-6218036	Delco	REC3423A1	REC34235T	REC33662	REC1396-5238
488	L-4	1983-84	6170297-6916778	Delco	REC3423A1	REC34235T	REC33662	REC1396-5238
Prestolite	L-4				REC392-6324Q1	REC8M6001219	REC8M6001217	REC3853801
L6								
140	L-6	1963	1538930-1725960	Delco	REC3423A1	REC34235T	REC33662	REC1396-5238
150	L-6	1964-66	1666495-2048046	Delco	REC3423A1	REC34235T	REC33662	REC1396-5238
160	L-6	1967-69	2048022-2494926	Delco	REC3423A1	REC34235T	REC33662	REC1396-5238
160	L-6	1969	2494927-2770031	Delco	REC3423A1	REC34235T	REC33662	REC1396-5238
165	L-6	1971-81	2771484-5813433	Delco	REC3423A1	REC34235T	REC33662	REC1396-5238
165	L-6	1970	2770032-2771483	Delco	REC3423A1	REC34235T	REC33662	REC1396-5238
200	L-6	1969	2453769-2712072	Delco	REC3423A1	REC34235T	REC33662	REC1396-5238
Prestolite	L-6				REC392-6324Q1	REC8M6001219	REC8M6001249	REC3853801
V6								
185 (4 BBL.) (3.8L)	V-6	1983-84	6330183-6919655	Prestolite	REC392-6324Q1	REC8M6001219	REC8M6001249	REC3853801
V8								
190 (GM 283)	V-8	1963-64	1564539-1730903	Delco	REC801766			
215 MCM y MIE (Ford 302)	V-8	1970-72	2781153-3563181	Autolite	REC801768	REC3302-804844002	REC64851	REC65864
215 MCM y MIE (Ford 302)	V-8	1970-72	2781153-3562181	Mallory	REC391-5090Q1	REC391-5090	REC8M6001217	REC89825302
225 MCM y MIE	V-8	1973-74	3385721-4166999	Autolite	REC801768	REC3302-804844002	REC64851	REC65864
225 MCM y MIE	V-8	1973-74	3385721-4166999	Mallory	REC391-5090Q1	REC391-5090	REC8M6001217	REC89825302
225 MCM y MIE	V-8	1973-74	3385721-4166999	Mercury	REC801767	REC71831	REC64851	REC65864
888 (Ford 302)	V-8	1971-77	3108723-4887829	Mercury	REC801767	REC71831	REC8M6001217	REC65864
888 (Ford 302)	V-8	1971-77	3108723-4887829	Prestolite	REC392-6325Q1	REC8M6001219	REC8M6001249	REC834975
888 (Ford 302)	V-8	1971-77	3108723-4887829	Mallory	REC391-5090Q1	REC391-5090	REC8M6001217	REC89825302
888 (Ford 302)	V-8	1971-77	3108723-4887829	Autolite	REC801768	REC3302-804844002	REC64851	REC65864
225 (GM 327)	V-8	1963-69	1539620-2694014	Delco	REC801766			
228 MCM & MIE	V-8	1977-82	4765100-6218461	Mallory	REC391-5090Q1	REC391-5090	REC8M6001217	REC89825302
898/198 MCM & MIE	V-8	1977-82	4762210-6218461	Mallory	REC391-5090Q1	REC391-5090	REC8M6001217	REC89825302

MOD.	CYL	AÑO YEAR ANNEE	SERIE SERIAL SERIE	ARRANQUE IGNITION ACCENSIONE ALLUMAGE	KIT	PLATINO POINT PUNTINE VIS PLATINÉES	CONDENSADOR CONDENSER CONDENSATEUR CONDENSATEURS	ROTOR ROTOR ROTORE DOIGT D'ALLUM.
233 MCM & MIE	V-8	1975-77	4173000-4902304	Mercury	REC801767	REC71831	REC64851	REC65864
233 MCM & MIE	V-8	1975-77	4173000-4902304	Prestolite	REC392-6325Q1	REC8M6001219	REC8M6001249	REC834975
233 MCM & MIE	V-8	1975-77	4173000-4902304	Prestolite	REC392-6324Q1	REC8M6001219	REC8M6001249	REC3853801
250 (GM 350)	V-8	1977	4768000-4908849	Mallory	REC391-5090Q1	REC391-5090	REC8M6001217	REC89825302
255 MIE y MCM (Ford 351)	V-8	1973-80	3258728-5907057	Mallory	REC391-5090Q1	REC391-5090	REC8M6001217	REC89825302
255 MCM y MIE (Ford 351)	V-8	1973-80	3258728-5907057	Mercury	REC801767	REC71831	REC64851	REC65864
255 (GM 350)	V-8	1975-76	3258728-4501254	Mallory	REC391-5090Q1	REC391-5090	REC8M6001217	REC89825302
255 (GM 350)	V-8	1976	4498701-4767999	Mercury	REC801767	REC71831	REC64851	REC65864
260	V-8	1978-82	4908850-6128461	Mallory	REC391-5090Q1	REC391-5090	REC8M6001217	REC89825302
5.7L Ski	V-8	1985-95	0A338533-0F775199	Mallory	REC391-5090Q1	REC391-5090	REC8M6001217	REC89825302
5.7L Ski	V-8	1985-95	0A338533-0F775199	Prestolite	REC392-6324Q1	REC8M6001219	REC8M6001249	REC3853801
280 TRS	V-8	1975	4176250-4499390	Mercury	REC801767	REC71831	REC64851	REC65864
280 TRS	V-8	1976	4499391-4770199	Mallory	REC391-5090Q1	REC391-5090	REC8M6001217	REC89825302
330 MCM y MIE	V-8	1977-81	4623115-6083144	Mallory	REC391-5090Q1	REC391-5090	REC8M6001217	REC89825302
370 TRS	V-8	1978-85	4179554-6721527	Mallory	REC391-5090Q1	REC391-5090	REC8M6001217	REC89825302
370 TRS	V-8	1978-85	4883520-6721527	Holley	REC801767	REC71831	REC64851	REC65864
400 TRS	V-8	1980-86	5668232-0B457644	Mallory	REC391-5090Q1	REC391-5090	REC8M6001217	REC89825302
400 TRS	V-8	1980-86	5668232-0B457644	Holley	REC801767	REC71831	REC64851	REC65864
440 TRS	V-8	1983-86	6181070-0B485220	Mallory	REC391-5090Q1	REC391-5090	REC8M6001217	REC89825302
440 TRS	V-8	1983-86	6181070-0B485220	Holley	REC801767	REC71831	REC64851	REC65864
460 TRS	V-8	1983-86	6180970-6181046	Mallory	REC391-5090Q1	REC391-5090	REC8M6001217	REC89825302
460 TRS	V-8	1983-86	6180970-6181046	Holley	REC801767	REC71831	REC64851	REC65864

**KITS DE CONVERSIÓN
ELECTRÓNICO**

Sustituyen condensadores y contactos por componentes electrónicos. Usa bobina, tapa y rotor estándar. Fácil instalación, una pieza y dos cables. Precisión entre 1/4" calibrado de 0 a 8000 rpm.

**ELECTRONIC
CONVERSION KITS**

To substitute condensers for electronic devices. Uses standard coil, cap & rotor. Easy installation; one piece, two cables. Precisely calibrated between 1/4" from 0 to 8000.

**KIT DI CONVERSIONE
ELETTRICO**

Sostituiscce condensatori e contatti per componenti elettronici. Utilizza bobina, calotta e rotore standard. Facile installazione, una pz e due cavi. Precisione 1/4" calibrato da 0 a 8000.

**KITS DE CONVERSION
ÉLECTRONIQUE**

Remplace les condensateurs et les contacts par des composants électroniques. Utilisez une bobine, un couvercle et un rotor standard. Installation facile, une seule pièce et deux fils. Précision de 1/4" calibrée de 0 à 8000 rpm.

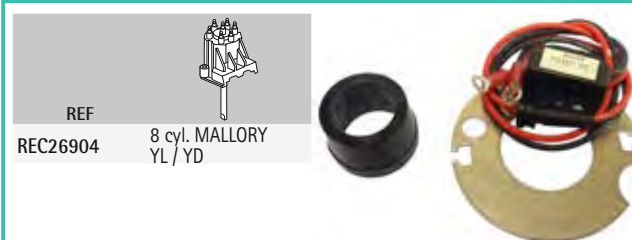
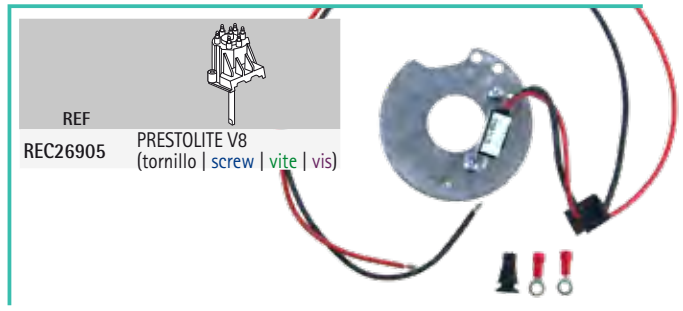

**GUÍA KITS DE CONVERSIÓN
ELECTRÓNICO**

**ELECTRONIC CONVERSION
KIT APPLICATION**

**GUIDA KIT CONVERSIONE
ELETTRICO**

**GUIDE KITS DE CONVERSION
ÉLECTRONIQUE**

MOD.	CYL	SERIE SERIAL SERIE	ARRANQUE IGNITION ACCENSIONE ALLUMAGE	KIT
470R	4	6218037	Delco	REC26900
485	4	5685394	Delco	REC26900
488R	4	6170297	Delco	REC26900
140	6	1538930 - 1725960	Delco	REC26901
150	6	1666495 - 2048046	Delco	REC26901
160	6	2048022 - 2770031	Delco	REC26901
165	6	2770032	Delco	REC26901
Alpha 1/120-140	6	6229718	Delco	REC26901
200	6	2453769 - 2712072	Delco	REC26901
198	8	4776402	Mallory YL670AV	REC26904
215	8	2781153	Mallory YL670AV	REC26904
225	8	3385721	Mallory YL670AV	REC26904
228	8	4765100 - 6218461	Mallory YL670AV	REC26904
233	8	4173000	Prestolite	REC26905

MOD.	CYL	SERIE SERIAL SERIE	ARRANQUE IGNITION ACCENSIONE ALLUMAGE	KIT
233	8	4173000	Prestolite (tornillo screw vite vis)	REC26905
198	8	4776402	Mallory	YL670AV REC26904
250	8	4768000 - 4908849	Mallory	YL670AV REC26904
255	8	3258728	Mallory	YL670AV REC26904
260	8	4908850 - 6218461	Mallory	YL670AV REC26904
260	8	A338553+	Mallory	YL670AV REC26904
280	8	4499391	Mallory	YL670AV REC26904
330	8	4623115	Mallory	YL670AV REC26904
370, 400, 440, 460TRS	8	4179554	Mallory	YL670AV REC26904
888	8	3108723	Mallory	YL670AV REC26904
888	8	3108723	Prestolite	REC26905
888	8	4762210 - 6218461	Mallory	YL670AV REC26904
5.7	8	85B14627+	Ski Mallory	YL670AV REC26904

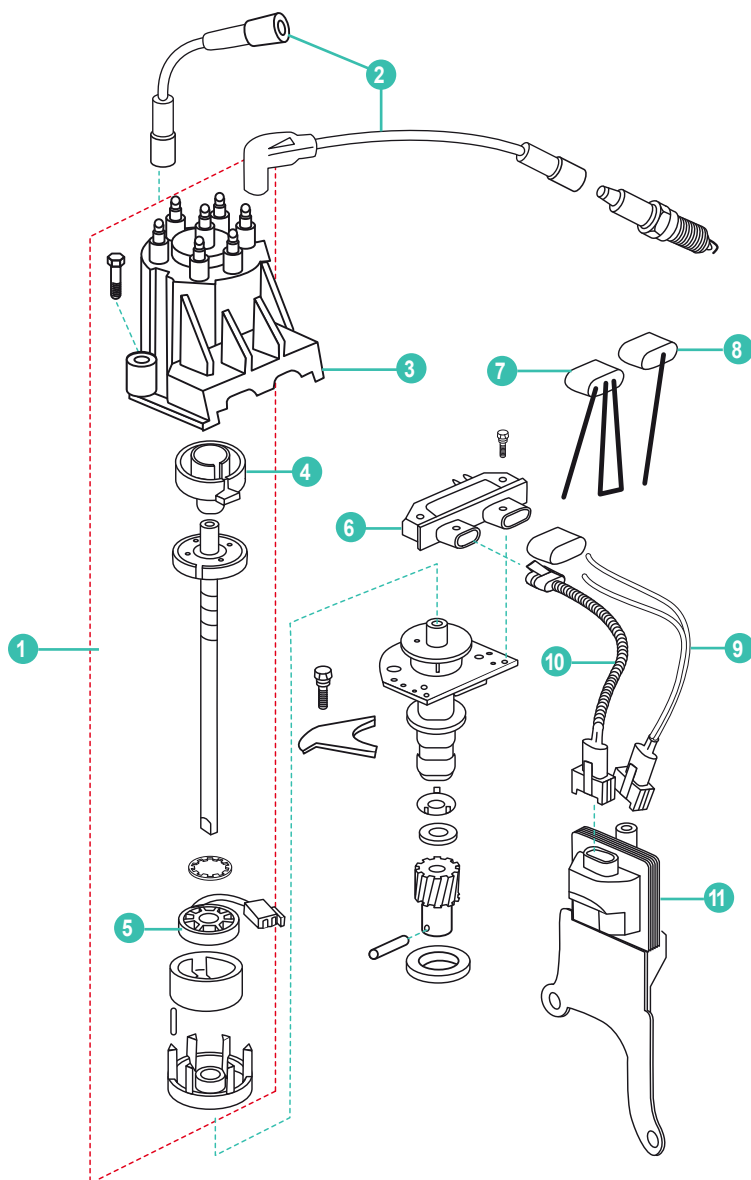

REF	OEM				
REC817377	817377	DISTRIBUIDOR 4 CYL	DISTRIBUTOR 4 CYL	DISTRIBUTORE 4 CYL	DISTRIBUTEUR 4 CYL
1 REC807964A1	807964A1	DISTRIBUIDOR 6 CYL	DISTRIBUTOR 6 CYL	DISTRIBUTORE 6 CYL	DISTRIBUTEUR 6 CYL
REC805222A1	805222A1	DISTRIBUIDOR 8 CYL	DISTRIBUTOR 8 CYL	DISTRIBUTORE 8 CYL	DISTRIBUTEUR 8 CYL
REC15-405	84-816761Q13	KIT CABLE ARRANQUE: 3.0L	IGNITION WIRE SET: 3.0L	KIT CAVI INIEZIONE: 3.0L	KIT CÂBLE ALLUMAGE 3.0L
2 REC15-601	84-816761Q16	KIT CABLE ARRANQUE: V6	IGNITION WIRE SET: V6	KIT CAVI INIEZIONE: V6	KIT CÂBLE ALLUMAGE V6
REC15-804	84-816761Q17	KIT CABLE ARRANQUE: V8	IGNITION WIRE SET: V8	KIT CAVI INIEZIONE: V8	KIT CÂBLE ALLUMAGE V8
REC3854260	3854260	TAPA 4 CYL	CAP 4 CYL	COPERCHIO 4 CYL	COUVERCLE 4 CYL
3 REC3854331	3854331	TAPA 6 CYL	CAP 6 CYL	COPERCHIO 6 CYL	COUVERCLE 6 CYL
REC3854548	3854548	TAPA 8 CYL	CAP 8 CYL	COPERCHIO 8 CYL	COUVERCLE 8 CYL
REC3854311	850485	ROTOR V6	ROTOR V6	ROTORE V6	DOIGT D'ALLUMAGE V6
4 REC3854549	8M6001253	ROTOR V8	ROTOR: V8	ROTORE: V8	DOIGT D'ALLUMAGE V8
REC3854261	8M6001254	ROTOR 4 CYL	ROTOR 4 CYL	ROTORE 4 CYL	DOIGT D'ALLUMAGE 4 CYL
5 REC3854001	811639T	MÓDULO IMPULSOS	MODULE	MODULO	MODULE
6 REC3854003	811637001	MÓDULO DISTRIBUIDOR	MODULE: DISTRIBUTOR	MODULO DISTRIBUZIONE	MODULE DISTRIBUTEUR
7 REC91-888863	91-888863	HERRAMIENTA DISTRIBUIDOR	TOOL: TIMING	STRUMENTO DISTRIBUZIONE	TIMING JUMPER ALLUMAGE
8 REC294005		CABLE: INTERRUPTOR	WIRE: SHIFT INTERRUPTER	CAVO: INTERRUPTORE	FAISCEAU POUR SHIFT INTERRUPTEUR
9 REC500442		CABLE: BOBINA	WIRE LEAD: COIL HARNESS	CAVO BOBINA	FAISCEAU POUR BOBINE
10 REC84-817376T01	84-817376T01	CABLE: DISTRIBUIDOR - BOBINA	WIRE LEAD: DISTRIBUTOR - COIL	CAVO: DISTRIBUZIONE - BOBINA	FAISCEAU DISTRIBUTEUR - BOBINE
11 REC3854002	898253T27	BOBINA ARRANQUE	COIL: IGNITION	BOBINA INIEZIONE	BOBINE D'ALLUMAGE

THUNDERBOLT IV & V

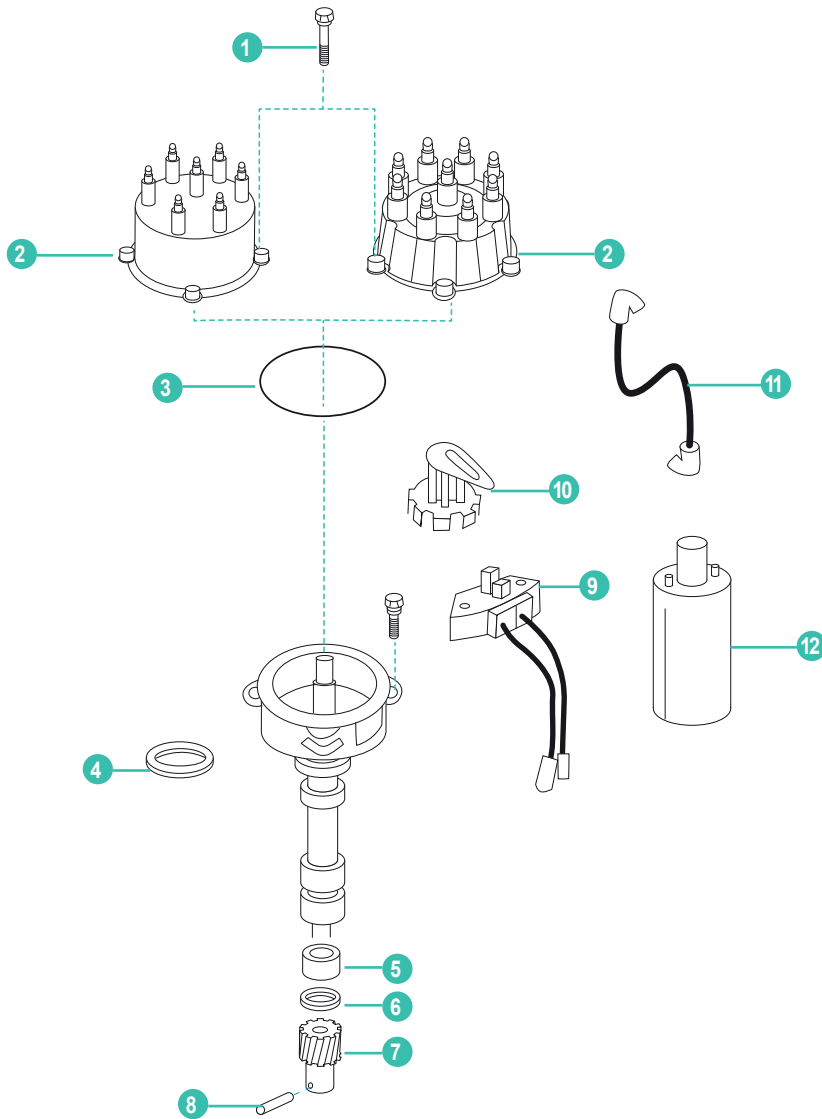

REF	OEM				
REC805185A3	805185A37	DISTRIBUIDOR V6 CON TERMINAL	DISTRIBUTOR ASSY. V6 W/BULLET	SPINTEROGENO V6 CON TERMINALI	DISTRIBUTEUR V6 AVEC TERMINAL
REC805185A36	805185A36	DISTRIBUIDOR V8 CON TERMINAL	DISTRIBUTOR ASSY. V8 W/BULLET	SPINTEROGENO V8 CON TERMINALI	DISTRIBUTEUR V8 VEC TERMINAL
1 REC10-90926	10-90926	TORNILLO	SCREW	VITE	VIS
2 REC815407A2	815407Q02	TAPA DISTRIBUIDOR V6	DISTRIBUTOR CAP V6	CALOTTA V6	TÊTE D'ALLUMEUR V6
REC805759Q01	805759Q01	TAPA DISTRIBUIDOR V8	DISTRIBUTOR CAP V8	CALOTTA V6	TÊTE D'ALLUMEUR V8
3 REC27-805760	27-805760	JUNTA	GASKET	GUARNIZIONE	JOINT
4 REC27-344861	27-34486-3	JUNTA	GASKET	GUARNIZIONE	JOINT
5 REC23-90915	23-90915	CASQUILLO	BUSHING	BOCCOLA	BAGUE
6 REC12-90931	12-90931	ARANDELA	WASHER	RONDELLA	RONDELLE
7 REC43-818807	43-818807	PIÑÓN DELCO	DRIVE GEAR	PIGNONE DELCO	PIGNON D'ALLUMEUR
8 REC17-47617	17-47617	PASADOR	PIN	CHIAVISTELLO	PIN
9 REC87-892150Q02	87-892150Q02	MÓDULO DISTRIBUIDOR	SENSOR ASSEMBLY	MODULO SPINTEROGENO	MODULE DISTRIBUTEUR
10 REC13524A6	13524Q06	ROTOR V6	ROTOR ASSEMBLY V6	ROTORE V6	DOIGT D'ALLUMAGE V6
REC13524A1	13524T1	ROTOR V8	ROTOR ASSEMBLY V8	ROTORE V8	DOIGT D'ALLUMAGE V8
11 REC15-601	84-816761Q16	KIT CABLES BUJÍAS V6	WIRES KIT V6	KIT CAVI V6	FAISCEAU BOUGIES V6
REC15-804	84-816761Q17	KIT CABLES BUJÍAS V8	WIRES KIT V8	KIT CAVI V8	FAISCEAU BOUGIES V8
12 REC300-00879	392-805570A2	BOBINA	COIL	BOBINA	BOBINE

MPI V6 & V8

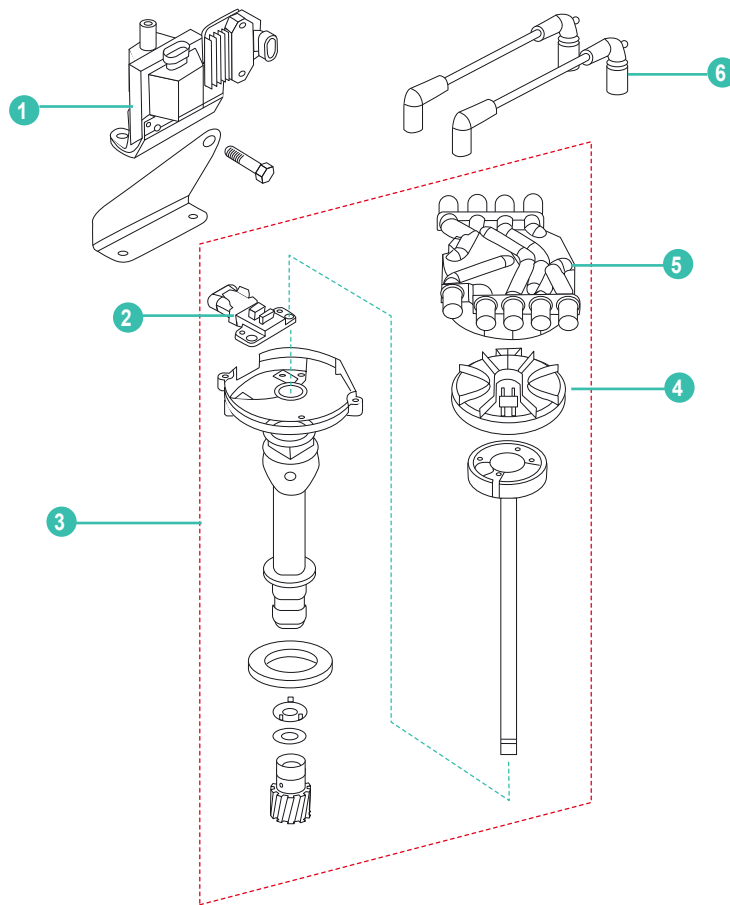



	REF	OEM				
1	REC3861985	392-8M0054588	BOBINA ENCENDIDO	IGNITION COIL	BOBINA INIEZIONE	BOBINE D'ALLUMAGE
2	REC3863130	898141	SENSOR POSICIÓN ÁRBOL DE LEVAS	DISTRIBUTOR PICK-UP	SENSORE POSIZIONE ALBERO A CAMME	SONDE POSITION ARBRE A CAMES
3	REC40005334	888751A03	DISTRIBUIDOR V6	DISTRIBUTOR V6	DISTRIBUTORE V6	DISTRIBUTEUR V6
	REC21622232	879150A87	DISTRIBUIDOR V8	DISTRIBUTOR V8	DISTRIBUTORE V8	DISTRIBUTEUR V8
4	REC898253013	8M6001222	ROTOR	ROTOR	ROTORE	DOIGT D'ALLUMAGE
5	REC898253T23	898253T23	TAPA V6	CAP V6	COPERCHIO V6	COUVERCLE V6
	REC898253T22	898253T22	TAPA V8	CAP V8	COPERCHIO V8	COUVERCLE V8
	REC15-606	84-863656A2	KIT CABLES V6	WIRES KIT V6	KIT CAVI V6	FAISCEAU V6
6	REC15-815	84-816608A1	KIT CABLES V8 (5.0L, 5.7L)	WIRES KIT V8 (5.0L, 5.7L)	KIT CAVI V8 (5.0L, 5.7L)	FAISCEAU V8 (5.0, 5.7L)
	REC15-813	84-863656A1	KIT CABLES V8 (6.2L)	WIRES KIT V8 (6.2L)	KIT CAVI V8 (6.2L)	FAISCEAU V8 (6.2L)

DISTRIBUIDOR

DISTRIBUTOR

SPINTEROGENO

DISTRIBUTEUR

REF	OEM		
REC40005334	888751A03 88751A02 888751A1	Vortec V6 4.3l MPI (2002+) (OM3000000+)	REC15-606





REF	OEM		
REC17177A1	17177A1 91823A3 816148A1 74905A3 68521A4 68521A3 13447A1	GM V8. (Small & large block) MALLORY YL 624 AV	REC15-801





REF	OEM		
REC21622232	884794A02 879150A87 884794A1	Vortec V8 2001+ 5.0L, 5.7L, 6.2L MPI (OM300000 +)	REC15-815





REF	OEM		
REC392-6316	392-6316	FORD 302 CID V8 MALLORY YL512CV	REC15-801



REF	OEM		
REC195141	87581T 195141 87581 62424 58231 52352 33266	GM 4 CIL. (120 & 140) MALLORY YL673AV	REC15-401



REF	OEM		
REC392-6330	392-6330	FORD 351 CID V8 MALLORY YL554CV	REC15-801

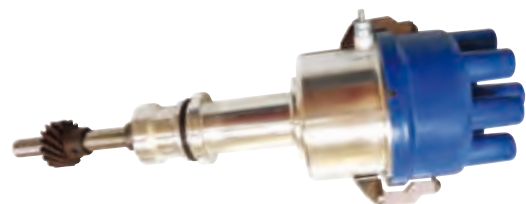

DISTRIBUIDOR ELECTRONICO **ELECTRONIC DISTRIBUTOR**



SPINTEROGENO ELETTRICO **DISTRIBUTEUR ELECTRONIQUE**

REF	OEM		
REC805185A3	805185A3	Vortec V6 4.3I MPI 20A V6. HEI Modernos Late Moderno Modernes	REC15-604







REF	OEM		
REC805185A36	805185A36	V8. (HEI Modernos Late Moderno Modernes)	REC15-801





REF	OEM		
REC817377	817377 817377T	181 RX (LX - MPI) Delco est ignition	REC15-405



REF	OEM			
REC805222A1	805222A1	V8 (EFI - TBI - MPI)	384 / 409	REC15-804
		262-454 & 452		



REF	OEM		
REC807964A1	807964A1 907964A1	V6 (EFI - TBI)	REC15-601



SISTEMA DE REFRIGERACIÓN COOLING SYSTEM

SISTEMA DI RAFFREDDAMENTO SYSTÈME DE REFROIDISSEMENT

TERMOSTATO	THERMOSTAT	TERMOSTATO	THERMOSTAT
KIT CUERPO DE TERMOSTATO	THERMOSTAT HOUSINGS KIT	KIT CORPO TERMOSTATO	KIT CORPS DE THERMOSTAT

REF	OEM	
REC87290A23	87290A26	V6 & V8 BLOQUE PEQUEÑO SMALL BLOCKS BLOCCO PICCOLO BLOQUE PETIT
REC90736A24	90736A24	V6 & V8 BLOQUE GRANDE BIG BLOCKS BLOCCO GRANDE BLOQUE GRAND

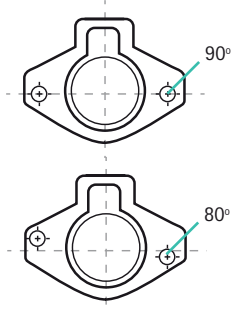

NOTA: reemplaza a este cuerpo
NOTE: replaces this housing
NOTA: sostituisce questo modello
REMARQUE : remplace ce corps



CUERPOS TERMOSTATO	THERMOSTATO HOUSING	CORPO TERMOSTATO	CORPS DE THERMOSTAT
--------------------	---------------------	------------------	---------------------

REF	OEM	
BAMC29-47587	861493A07 47587A2 47587 861493A3	GM 153, 181, 250, 292, 120, 140, 2.5L, 3.0, 3.0LX (4 cyl) (1964-97) 160, 165, 200 (6 cyl) (1967-81)



REF	OEM	
REC78984A08	78984A08 78984A1	198 MIE (2 bbl) GM 305 V8 (1977) 228, 228 MIE (4 bbl) GM 305 V8 (1977-80) 225 MIE GM 350 V-8 (1979-80) 260 (4 bbl) GM 350 V-8 (1978-82) 898 (2 bbl) GM 350 V-8 (1977-82)



REF	OEM	
REC87290A4	87290A4	4.3L V6 (1983-92) 5.0 & 5.7L V8 (1981-95) Race sterndrive GM454, 502 & 540 (1986-96)

REF	OEM	
BAMC29-78985	78985A1	330 GM454 V8 (1977-81)

REF	OEM	
RM863457A2	863457A2	4.3L, 350 MAG, 5.0L, 6.2L (MPI & MX)

Todos los motores de inyección con 1 o 3 puntos de drenaje.
All Injection with 1 or 3 point drain system.
Tutti i motori ad iniezione con 1 o 3 punti di drenaggio.
Tous les moteurs à injection avec 1 ou 3 points de vidange.

REF	OEM	
REC55131A5	55131A5	V6 & V8 con circuito de agua cerrado. with raw water cooling system. con circuito di acqua chiuso. avec circuit d'eau fermé.

REF	OEM	
BAMC29-63588	889333 63588A1	FORD V8 302 (1971-77) 351 (1973-77)

ACERO INOXIDABLE

Con cola Bravo. Incluye kit de casquillos para adaptarse a cualquier colector.

STAINLESS STEEL

With Bravo sterndrive. Includes bushing kit to fit any manifold.

ACCIAIO INOX

Con piede Bravo. Il kit include boccole per adattarsi a qualsiasi collettore.

ACIER INOXYDABLE

Avec l'embase Bravo. Comprend un kit de bagues pour s'adapter à n'importe quel collecteur.

REF	OEM	
REC8M0061381	861006A1 8M0061381 860256A4	GM V6 & V8 (305, 350, 357, 383) 4.3, 5.0, 5.7, 6.2L 7.4 & 8.2L (1998+)



CASQUILLO TERMOSTATO

THERMOSTAT SLEEVE

BOCCOLA TERMOSTATO

CALE DE THERMOSTAT

REF	OEM	
REC23-806922	23-806922	Para la mayoría de 3.0L, V6, V8 Fits most 3.0L, V6, V8 Si adatta maggiormente 3.0L, V6, V8 Pour la plupart des 3.0L, V6, V8



VÁLVULA "T" TERMOSTATO	TEE VALVE ASSY	VALVOLA "T" TERMOSTATO	TE VALVE THERMOSTAT
------------------------	----------------	------------------------	---------------------

REF	OEM		CUERPO DE TERMOSTATO THERMOSTAT HOUSING CORPO TERMOSTATO CORPS THERMOSTAT
REC22-98477A2	22-98477A2	GM V6 & V8	REC87290A4



EJE VÁLVULA TERMOSTATO	CHECK BALL KIT	ASSE VALVOLA TERMOSTATO	AXE VALVE THERMOSTATIQUE
------------------------	----------------	-------------------------	--------------------------

REF	OEM		MCM R/MR/ALPHA ONE (1983-90)
REC30-98475T1	30-98475T1		



MÓDULO DISTRIBUCIÓN DE AGUA	WATER DISTRIBUTION MODULE	MODULO DISTRIBUZIONE ACQUA	MODULE DE DISTRIBUTION D'EAU
-----------------------------	---------------------------	----------------------------	------------------------------

REF	OEM		GM 4.3, 5.0, 5.7 & 6.2L (MPI)
RM863631T1	863631T1		

Drenaje manual
Manual drain
Drenaggio manuale
Drainage manuel



REF	OEM		GM 4.3, 5.0, 5.7 & 6.2L (MPI)
RM863444T1	863444T1		

Varilla accionada
Rod actuated
Asta azionata
Tige motrice



REF	OEM		V6 & V8 AIR ACTUATED DRAIN
REC863802T2	863802T2		

new



CONECTOR RÁPIDO	FITTING	CONNETTORE	RACCORD VIDANGE
-----------------	---------	------------	-----------------

REF	OEM		4 CYL INLINE V6 & V8
REC22-862225	22-862225		

new



CUBIERTAS TERMOSTATO THERMOSTATO COVER

REF	OEM	CUERPO HOUSING CORPO CORPS	
BAMC29-60372	60372A1 60372A2 861493A07	BAMC29-47587	4 Et 6 cyl inline



COPERCHIO TERMOSTATO COUVERCLE DE THERMOSTAT

REF	OEM	CUERPO HOUSING CORPO CORPS	
REC8M0061068	47442A1	BAMC29-78985	454, 502, V8 BIG BLOCK



REF	OEM	CUERPO HOUSING CORPO CORPS		
BAMC29-62898	62898A1 62898	BAMC29-63588		Con colas With sterndrive Con Piede Avec embases
BAMC29-59498	59498 59498A1	BAMC29-63588		Con Eje With Shaft Con asse Avec arbre



REF	OEM	CUERPO HOUSING CORPO CORPS	
REC47441A1	47441A1	REC87290A4	262 V6 / 305, 350 V8 SMALL BLOCK



JUNTAS TERMOSTATO

THERMOSTATO GASKETS

GUARNIZIONI TERMOSTATO

JOINTS DE THERMOSTAT

REF	OEM	CASQUILLO SLEEVE BOCCOLA BAGUE
REC25-30224	25-30224	REC23-806922
REC27-47510Q	27-47510Q	REC23-47508T



REC25-30224



REC27-47510Q

CUERPO TERMOSTATO --> CULATA

THERM. HOUSING --> CYLINDER HEAD

CORPO TERMOSTATO --> TESTATA

CORPS THERMOSTAT --> TÊTE MOTEUR

REF	OEM	CUERPO HOUSING CORPO CORPS	
REC27-8146801	27-8146801	BAMC29-47587	4 Et 6 cyl inline



JUNTA TAPA --> CUERPO TERM.

COVER --> THERMOSTAT HOUSING

COPERCHIO --> CORPO TERM.

JOINT COUVERCLE --> CORPS THERM.

REF	OEM
REC27-33179Q02	27-33179Q02



REF	OEM
REC17494A1	17494A1

Tapa y junta
Cover Et gasket
Coperchio e guarnizione
couvercle et joint



DEPOSITO --> CUERPO TERM.

TANK --> THERMOSTAT HOUSING

SERBATOIO --> CORPO TERM.

DEPOSIT --> CORPS THERM.

REF	OEM	
REC27-74830	27-74830	MCM 470 3.7L (1976-82)



BY-PASS --> TERMOSTATO BY-PASS --> THERMOSTAT HOUSING BY-PASS --> TERMOSTATO BY-PASS --> THERMOSTAT

REF	OEM	
REC27-41812Q	27-41812Q 27-41812	GM V6 / V8 SMALL BLOCK
REC27-418122	27-418122	GM 454 / 502 V8 BIG BLOCK
REC27-48818Q01	27-48818Q01	GM V8, SMALL & BIG BLOCK
REC27-475901	27-47590-1	4 & 6 cyl inline
REC27-60208Q	27-60208	Ford 302 / 351

REC27-41812Q REC27-418122 REC27-48818Q01

REC27-475901 REC27-60208Q

CUERPO TERM. --> COL. ADMISIÓN THERM. HOUSING --> INTAKE MANIFOLD CORPO TERM. --> COL. ASPIRAZIONE CORPS THERM. --> COL. ADMISION

REF	OEM	
REC27-53045Q01	27-53045Q01 53051	GM V6 & V8
REC27-33918	27-8M2021920	GM 4 & 6 cyl inline
REC27-54506	27-5450	FORD 302/351
REC27-89656-1	27-89656-1	MCM 470 3,7 L (1976-82)

REC27-53045Q01 REC27-33918 REC27-54506 REC27-89656-1

D DIESEL TERMOSTATO THERMOSTATO TERMOSTATO THERMOSTAT

REF	OEM	
REC8M0093561	8M0093561 879194215 879194233 879194231 896332148	CMD 2,8 / 4.2

new

REF	OEM	
REC8M0093480	8M0093480 8M0067292 8M0066646	TDI 3.0L

new

GAS KITS TERMOSTATO THERMOSTATO KIT KIT TERMOSTATO KITS THERMOSTAT

REF	OEM		°C
REC59078Q3	59078Q3	4 & 6 CYL INLINE	60°

REF	OEM		°C
REC864493	864493	4.3L CARB ALPHA / BRAVO 4.3L MPI ALPHA / BRAVO 4.5L MPI (FRESH WATER) 350 MAG MPI ALPHA / BRAVO 357 HRZ 377 MAG MPI 5.0L MPI ALPHA / BRAVO 5.7L MPI 6.2L MPI	80°

REF	OEM		°C
REC8M0091470	807252T2 8M0091470	GM V6 Et V8, 181° Modelos modernos Late models Modelli moderni Modèles modernes	70°



REF	OEM		°C
REC99155T2	99155T2	4 cyl 224 (3.7L)	70°

Motores con colector escape de aluminio y circuito de refrigeración cerrado.
Engines with closed cooling & aluminum exhaust manifold
Motori con circuito di refrigerazione chiuso e colettore di scarico in alluminio
Moteurs avec collecteur d'échappement en aluminium et circuit de refroidissement fermé.





REF	OEM		°C
REC807252Q5	807252Q5	GM V6 Et V8° Modelos modernos Late models Modelli moderni Modèles modernes	70°





REF	OEM		°C
REC8M0089715	807252T1 8M0089715	GM V6 Et V8, Ford V8 4.5L MPI (RAW WATER) 6.2L MPI (RAW WATER)	60°



REF	OEM		°C
REC807252Q3	807252Q3	FORD V8	60°



REF	OEM		°C
REC807252Q4	807252Q4 807252T4	GM V6 Et V8 4.5L MPI (RAW WATER) 6.2L MPI (RAW WATER)	60°



INTERCAMBIADOR DE CALOR

HEAT EXCHANGER

SCAMBIATORE DI CALORE

ÉCHANGEUR DE CHALEUR

Para saber cual es la ref. que comprende a su motor, informar del modelo de motor y nº de serie

To know which is the model you need, please inform the model and serial number of the engine.

Per sapere il modello corretto, fornire all'assistenza clienti il numero di serie del motore.

Pour savoir quelle est la référence de votre moteur, veuillez indiquer le modèle et le numéro de série du moteur.

REF	OEM
RM99438A1	99438A1



KITS INTERCAMBIADOR

HEAT EXCHANGER KITS

KIT SCAMBIATORI

KITS ÉCHANGEUR

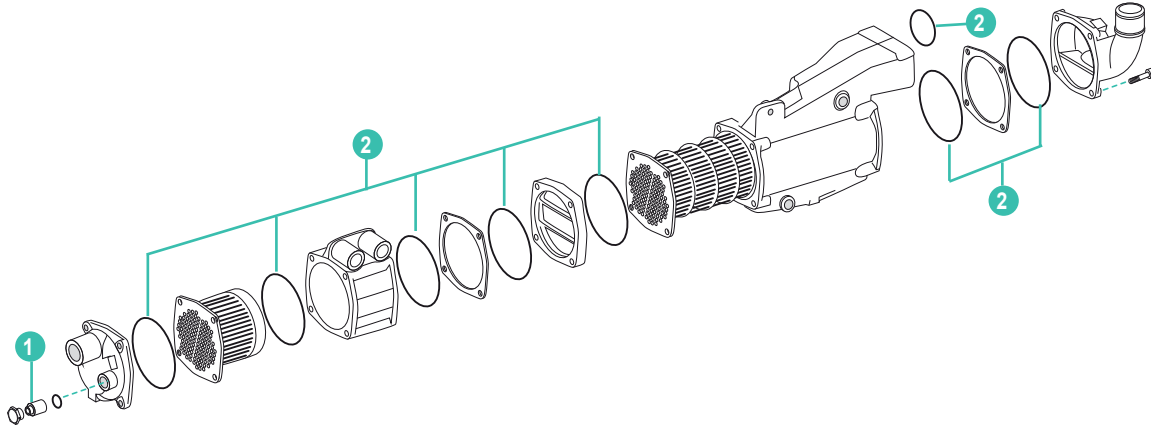

2	OEM	new
REC32126	25-896332126 25-89633	CMD, CMQSD 2.8 CMQSD4.2

1	OEM
TEN01320T	

3	OEM	new
REC25-8M0084884	8M0084884 25-8M0039163 25-8071341 25-26802	4.5L MPI, 4.3 MPI 350 MPI / 5.0L MPI 383 MAG/MPI 6.2L MPI

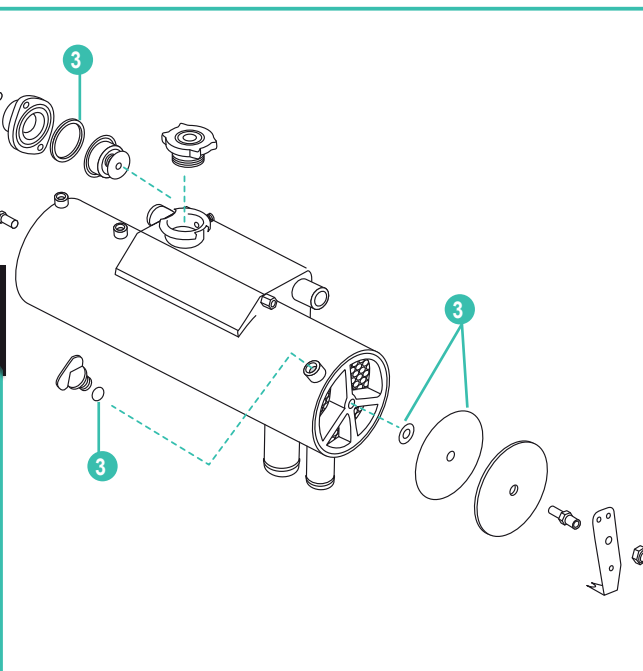

ENFRIADOR DE ACEITE

OIL COOLER

RAFFREDDAMENTO DELL'OLIO

REFROIDISSEUR D'HUILE

Para saber cual es la ref. que comprende a su motor, informar del modelo de motor y n° de serie

To know which is the model you need, please inform the model and serial number of the engine.

Per sapere il modello corretto, fornire all'assistenza clienti il numero di serie del motore.

Pour savoir quelle est la référence de votre moteur, veuillez indiquer le modèle et le numéro de série du moteur.

REF	OEM
RM807371T1	807371T1
REC99356A2	99356A2
RM99356A1	99356A1
REC89690T	89690T



KITS ENFRIADOR DE ACEITE

OIL COOLER KITS

KIT GUARNIZIONE RAFFREDDAMENTO OLIO

KIT JOINT REFROIDISSEUR D'HUILE

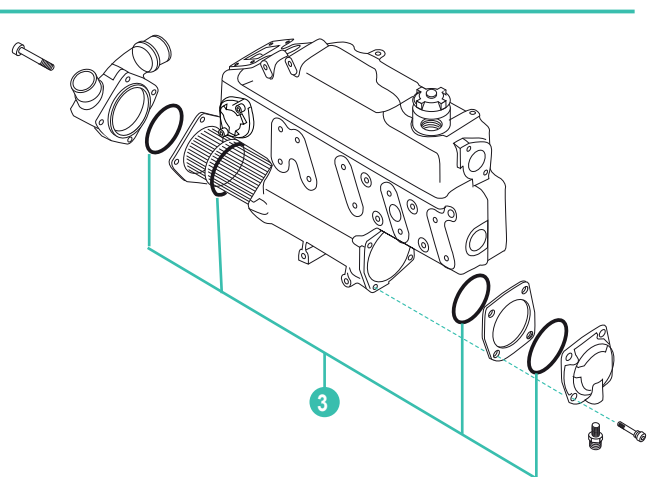
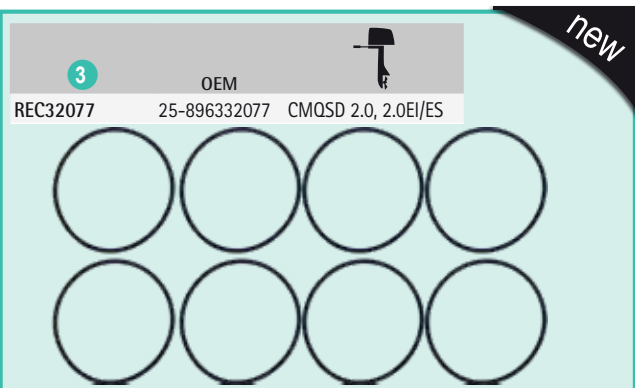
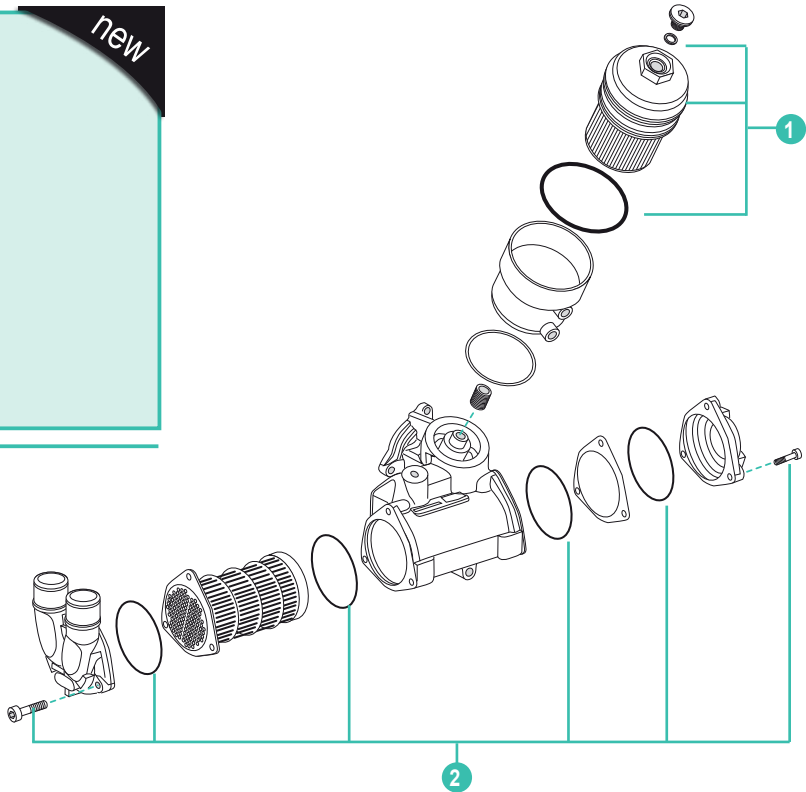
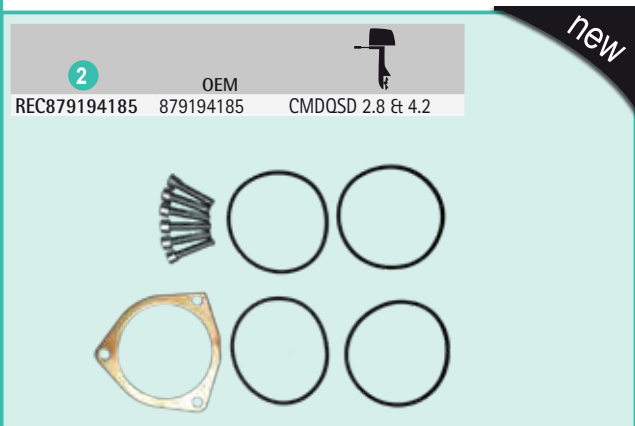

KITS BOTELLAS DE ACEITE RESERVOIR ASSY KITS

REF	OEM
RM806193A48	806193A48 806193A38 806193A20 19742A1 19742A3

KIT BOTTIGLIA OLIO

REF	OEM
REC22-861150T02	22-861150T02 22-861150A1 22-861150A2
RM22-861163	22-861163
RM53-87843	53-87843

KIT RESERVOIR D'HUILE

BOMBAS DE AGUA

WATER PUMPS

POMPE ACQUA

POMPE D'EAU

BOMBAS DE AGUA

WATER PUMPS

POMPE ACQUA

POMPE D'EAU

REF	OEM	Icon	Description
REC46-8M0113733	884727 8M0113733		GM 4 Et 6 CYL INLINE

REF	OEM	Icon	Description
REC879194401	46-879194401 8M0094406 8M6005225		V6 (2007+) (Sin bypass without water bypass hole senza bypass sans bypass) MCM MPI (OW658583+) MCM Carb. (1A063240+)

REF	OEM	Icon	Description
REC46-8M0113734	8503991 8M0113734		GM 4 Et 6 CYGM V6 Et V8 SMALL BLOCK



REF	OEM	Icon	Description
RM46-807151A8 46-72774A69	46-807151A8 46-72774A69	 	MerCruiser 454 Magnum 7.4 Et 502 Con acople bomba gasolina. Includes fuel pump adapter. Con accoppiamento pompa benzina. Avec accouplement de la pompe à carburant. GEN V Et VI (1992-99)

REF	OEM	Icon	Description
REC46-8M0113735	8504541		GM V8 BIG BLOCK

REF	OEM	Icon	Description
REC46-8M0113736	883925 8M0113736		GM 8.1L

REF	OEM	
REC3853796	883885	FORD V8 302,351





REF	OEM			KIT
SHEG155	806152	Mercruiser 7.3L Diesel 7.3L (BRAVO & MIE) DIESEL NAV 444 V-8 (1994-96) (OF060000+)		REC47-59362Q01 SHE15979





REF	OEM		
SHEG151	805835	7.3L (BRAVO & MIE) DIESEL NAV444 V-8 (1994-96) D7.3L D-TRONIC 260LD (1999) D 7.3L D-TRONIC 300 (1999)	

SHE15000K



REF	OEM		
SHEG2603X	CUMMINS Diesel	SHE26000K	



REF	OEM			PORTS
REC8M0155633	8M0155633	CUMMINS 4.2QSD (270,320,350)		39.75 mm
REC8M0155633	897345016	3.0L VM V6 IB/SD (150, 230, 270)		
	8M0129714	REC15000K SHE15000K		



new

REF	OEM			PORTS
REC8M0148530	8M0148530	MERCURISER CUMMINS MARINE		40.5 mm
	854179001	CMD 2.8 EI, ES (170/200)		
SHEP1016	879312023	CMD QSD 2.8 EI, ES (170/210/220/230)		
	8M0148530	CMD QSD 2.0 EI,ES (115/130/150)		



new

**BOMBAS DE AGUA
BRONCE CON
TORNILLERIA DE INOX**

**WATER PUMPS
BRASS WITH STAINLESS
STEEL FITTINGS**

**POMPE ACQUA
IN BRONZO CON VITERIA
INOX.**



**POMPES À EAU
BRONZE AVEC VIS EN
ACIER INOXYDABLE**

REF	OEM				OEM
REC46-807151A9	46-807151A9	V6 & V8 con correa serpentin. with serpentine belt. con cinghia serpentina avec courroï serpentine		REC47-59362Q01	REC861579 861579 807731T





REF	OEM				OEM
REC46-862914T10	46-862914T10	4.3L MPI, 5.0L MPI, 350 MAG MPI Et MX, 8.2L MAG 6.2L MPI (ECM 555)	REC47-862232A2	REC862351T	862351T

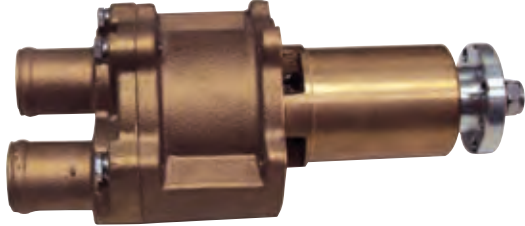



REF	OEM			kit 	
REC46-72774A32	46-807151A12 46-72774A32 46-59112A2 46-63450A2 46-72774A11 46-73823A7	V6 Et V8 con correa V. with V belt. con cinghia V avec courroie V	REC47-59362Q01	REC47-59362A4	

JUNTAS BOMBAS DE AGUA **WATER PUMPS GASKETS** **GUARNIZIONE POMPE DELL'ACQUA** **JOINTS DE POMPE D'EAU**

REF	OEM		BOMBA PUMP POMPA POMPE
REC27-803192A2	24-803192A2	454-502 CHEVY	REC46-8M0113735





REF	OEM		BOMBA PUMP POMPA POMPE
REC27-34897	27-34897	GM V6 Et V8 (Bloque pequeño Small block blocco piccolo Bloque petit)	REC879194401 REC46-8M0113734





REF	OEM		BOMBA PUMP POMPA POMPE
REC27-56880	27-56880	Ford V8 (302, 351)	REC3853796



REF	OEM		BOMBA PUMP POMPA POMPE
REC27-49110	27-49110	V-8 (Bloque grande big block blocco grande bloque grand) 454-502 CHEVY	REC46-8M0113735



REF	OEM		BOMBA PUMP POMPA POMPE
REC27-33956	27-33956	4 Et 6 Cyl.	REC46-8M0113733



		OEM	SHERWOOD	CEF	JOHNSON	JABSCO	RECMAR	A (mm)	B (mm)	C (mm)
1	CUMMINS (SHERWOOD pump) G2601 Y G2603X. Núcleo estriado Fluted core Nucleo scanalato Noyau strié.	3972366	SHE26000K	CEF500183G				20	94,5	79,8
2	DIESEL 7.3 L	47-853126 3349198 3916720	SHE15000K	CEF500167			REC15000K	16	65	51,2
3	MC-1/R/MR/ALPHA ONE	47-89984T4		CEF500313G			REC47-89984T4	22,3	60	33,8
4	ALPHA GENE II	47-43026Q02		CEF500301			REC47-43026Q02	22,4	89	32,5
5	530DTA, 636DTA, D219, D183, D281, D4.2L	47-801332602		CEF500106GT	JOH09-1028B		REC3841697	14,29	65	50,2
6	BRAVO (inyección injection iniezione injection)	47-862232A2 47-8M0104229		CEF500159G			REC47-862232A2	11,4	66,5	50,6
7	HINO DIESEL	47-809866T 47-831311350		CEF500161			REC47-809866T	14,29	65	68,2
8	D254, D3.6L, D4.2L	47-816814T		CEF500177GT		JAB17018-0001	REC3593573	14,29	65,2	75,65
9	BRAVO	47-59362Q01		CEF500109			REC47-59362Q01	16,85	66,5	50,6
10	CMD QSD 2.0 & 2.8 SHERWOOD PUMP	47-879312025	SHE10615K	CEF500120T			REC10615K	15,9	65,2	41,3
11	CMD QSD 2.0 & 2.8 JABSCO PUMP	47-896332063		CEF500155		JAB11979-0001	REC11979-0001	14,29	58,65	36,65
12	CMD QSD 4.2 JABSCO PUMP	47-879194186		CEF500114T		JAB17937-0001-P	REC17937-0001	14,29	65	50,1
13	CMD QSD 4.2 SHERWOOD PUMP	8M0056956	SHE15000K	CEF500167			REC15000K	16	65	51,2

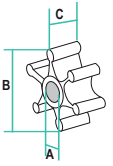

KITS DE REPARACIÓN
BOMBA DE AGUA

WATER PUMP
SERVICE KITS

KIT RICAMBI
POMPA ACQUA

KIT REPARATION DE
POMPE À EAU

1 | R | MR | ALPHA ONE

REF	OEM	
REC46-44292Q03	46-44292Q03	MR1 Alpha one (1984-90)



REF	OEM	
REC46-48748T1	46-48748A1 2495186 2763441	MR1 Alpha one (1967-69)





REF	OEM	
REC12120	46-96148A8	MR / ALPHA I (6225577+)





REF	OEM	
REC46-64141A11	46-64141A11	MC-1 (2062141-2791956)



REF	OEM	
REC46-48748T1	46-48748T1	MC-1 (1969+)



REF	OEM		NO
REC12110	MC-1 (2791957-6225576) (1970-83)		MR ALPHA ONE



KITS COMPLETOS

FULL KITS

REF	OEM	
RECMC00002		MR Et ALPHA ONE (622557+)



KIT COMPLETI

KITS COMPLETS

REF	OEM	
RECMC00001		MC-1 (2663442-6225576)



REF	OEM	
REC46-96148A8	46-60367A1 46-96148A8 46-96148A5	Parte superior. Upper water pump housing. Parte superiore. Partie supérieur MC-1 & ALPHA-ONE



OEM				
324351	TAPA BOMBA	PUMP COVER	COPERCHIO POMPA	COUVERCLE POMPE
12-191833	JUNTA	GASKET	GUARNIZIONE	JOINT
23-29804T	TUBO AGUA	WATER TUBE	TUBO ACQUA	TUYAU
25-30224Q	ARO	O-RING	ANELLO	JOINT SPI
25-30271	ARANDELA	WASHER	RONDELLA	RONDELLE
25-30613	ARO	O-RING	ANELLO	JOINT SPI
25-33145	ARO	O-RING	ANELLO	JOINT SPI
25-90011	ARO	O-RING	ANELLO	JOINT SPI
26-455771	RETÉN	SEAL	TENUTA	JOINT SPI
27-32438	JUNTA	GASKET	GUARNIZIONE	JOINT
27-426311	JUNTA	GASKET	GUARNIZIONE	JOINT
27-856081	JUNTA	GASKET	GUARNIZIONE	JOINT
27-856091	JUNTA	GASKET	GUARNIZIONE	JOINT
27-856704	JUNTA	GASKET	GUARNIZIONE	JOINT
48-96148T1	CUERPO BOMBA	PUMP HOUSING	CORPO POMPA	CORPS
47-89984T4	IMPULSOR	IMPELLER	GIRANTE	TURBINE

REF	OEM	
REC47-89984Q5	47-89984Q5	MC-1 & ALPHA-ONE



OEM				
324351	TAPA BOMBA	PUMP COVER	COPERCHIO POMPA	COUVERCLE POMPE
12-191833	JUNTA	GASKET	GUARNIZIONE	JOINT
23-29804T	TUBO AGUA	WATER TUBE	TUBO ACQUA	TUYAU
25-30224Q	ARO	O-RING	ANELLO	JOINT SPI
25-30271	ARANDELA	WASHER	RONDELLA	RONDELLE
25-30613	ARO	O-RING	ANELLO	JOINT SPI
25-33145	ARO	O-RING	ANELLO	JOINT SPI
25-90011	ARO	O-RING	ANELLO	JOINT SPI
26-455771	RETÉN	SEAL	TENUTA	JOINT SPI
27-32438	JUNTA	GASKET	GUARNIZIONE	JOINT
27-426311	JUNTA	GASKET	GUARNIZIONE	JOINT
27-856081	JUNTA	GASKET	GUARNIZIONE	JOINT
27-856091	JUNTA	GASKET	GUARNIZIONE	JOINT
27-856704	JUNTA	GASKET	GUARNIZIONE	JOINT
47-89984T4	IMPULSOR	IMPELLER	GIRANTE	TURBINE
26-38970	ACOPLE GOMA	COUPLING	ACCOPIAMENTO	ACCOUPLMENT
25-38099	ARO	O-RING	ANELLO	JOINT SPI
25-26722	ARO	O-RING	ANELLO	JOINT SPI

ALPHA ONE GEN II

REF	OEM	
REC47-43026Q06	47-43026Q06	



OEM				
47-43026Q2	IMPULSOR	IMPELLER	GIRANTE	TURBINE
8172761	PLACA	WEAR PLATE	PIASTRA	PLAQUE
27-8172771	JUNTA	GASKET	GUARNIZIONE	JOINT
27-430331	JUNTA	GASKET	GUARNIZIONE	JOINT
12-191833	JUNTA	GASKET	GUARNIZIONE	JOINT
28-8M0032833	CHAVETA	KEY	CHIAVE	CLAVETTE
26-816575A2	RETÉN	FACE SEAL	TENUTA	JOINT SPI
816597A1	ACOPAMIENTO	COUPLIN	ACCOPIAMENTO	ACCOUPLMENT

REF	OEM	
RECMC00004	47-89984Q5 (1991+)	



OEM				
8172761	PLACA	WEAR PLATE	PIASTRA	PLAQUE
27-430331	JUNTA	GASKET	GUARNIZIONE	JOINT
47-43026Q02	IMPULSOR	IMPELLER	GIRANTE	TURBINE
807929A1	RETÉN	PUMP SEAL CARRIER	TENUTA	JOINT SPI
27-8172772	JUNTA	GASKET	GUARNIZIONE	JOINT

REF	OEM	
REC817275Q05	817275Q05	D469859+



OEM				
46-96148T1	TAPA BOMBA	WATER PUMP HOUSING	COPERCHIO POMPA	COUVERCLE POMPE
27-430331	JUNTA	GASKET	GUARNIZIONE	JOINT
47-43026Q02	IMPULSOR	IMPELLER	GIRANTE	TURBINE
807929A1	RETÉN	SEAL	TENUTA	JOINT SPI
27-8172772	JUNTA	GASKET	GUARNIZIONE	JOINT
8172761	PLACA	WEAR PLATE	PIASTRA	PLAQUE

BRAVO I, II, III

REF	OEM	BOMBA PUMP POMPA POMPE
REC47-59362Q08	47-59362Q08	2 p, Plast.

REF	OEM
REC59503	59503

REF	OEM	
SHE15979	47-808145T	Diesel 7.3L

REF	OEM	BOMBA PUMP POMPA POMPE
REC47-59362T6	47-59362T6	1 p.

REF	OEM	BOMBA PUMP POMPA POMPE	
REC47-59362T5	47-59362T5	bronce brass bronzo Bronze	(-1982)

REF	OEM	BOMBA PUMP POMPA POMPE
REC46-807151A14	807151A14	1 p. Plast.

REF	OEM	
REC98-8M0121940	98-8M0121940	4.5 & 6.2L

REF	OEM	BOMBA PUMP POMPA POMPE
REC47-59362A4	47-59362A4	2 p.

DESPIECE BOMBA DE AGUA

WATER PUMP ASSY

ESPLOSO POMPA ACQUA

PIÈCES DE POMPE À EAU

BOMBA CON 2 PIEZAS DE PLÁSTICO
2 PCS. PLASTIC PUMP
POMPA CON 2 PZ IN PLASTICA
POMPE A 2 PIÈCES EN PLASTIQUE

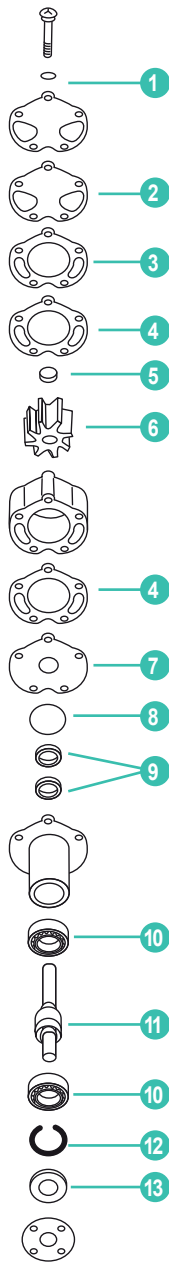

BOMBA CON 1 PIEZAS DE PLÁSTICO
1 PCS. PLASTIC PUMP
POMPA CON 1 PZ IN PLASTICA
POMPE A 1 PIÈCE EN PLASTIQUE

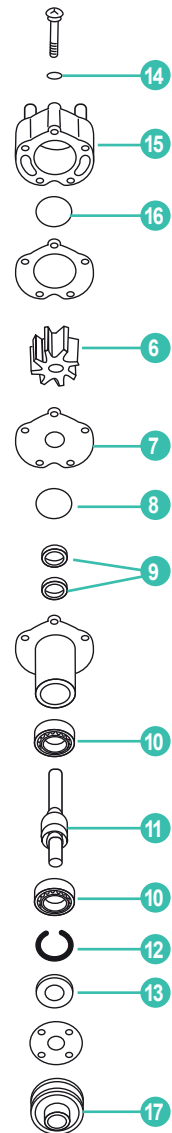

	REF	OEM					UN.
1	REC12-20084	12-20084	ARANDELA	WASHER	RONDELLA	RONDELLE	5
2	REC27-8052151	27-8052151	JUNTA	GASKET	GUARNIZIONE	JOINT	1
3	REC94916	94916	TAPA	WEAR PLATE	COPERCHIO	COUVERCLE	1
4	REC27-94914	27-94914	JUNTA	GASKET	GUARNIZIONE	JOINT	1
5	REC19-59504	19-59504	TAPÓN	PLUG	TAPPO	BOUCHON	1
6	REC47-59362Q01	47-59362Q01	IMPULSOR	IMPELLER	GIRANTE	TURBINE	1
7	REC94576	94576	TAPA	WEAR PLATE	PIASTRA	PLAQUE	1
8	REC25-94288	25-94288	ARO TÓRICO	O-RING	TENUTA	JOINT SPI	1
9	REC26-90562	26-90562	RETÉN	OIL SEAL	PARAOLIO	JOINT SPI	2
10	REC30-72961	30-72961	COJINETE	BEARING	CUSCINETTO	ROULEMENT	2
11	REC59501A1	59501A1	EJE	SHAFT	ASSE	ARBRE	1
12	REC53-23720	53-23720	ARO RETENEDOR	RETAINER RING	TENUTA	CLIPS	1
13	REC26-72785	26-72785	RETÉN ACEITE	OIL SEAL	PARAOLIO	JOINT SPI	1
14	PAGB/T97.1-8	12-36001	ARANDELA	WASHER	RONDELLA	RONDELLE	5
15	REC46-807151A14	46-807151A14	CUERPO BOMBA	PUMP HOUSING	CORPO POMPA	CORPS POMPA	1
16	REC25-33465	25-33465	ARANDELA	O-RING	RONDELLA	RONDELLE	1
17	REC861579	861579	POLEA	PULLEY	PULEGGIA	POULIE	1

POLEA BOMBA DE AGUA		WATER PUMPS PULLEY		PULIGGIA POMPE DELL'ACQUA		POULIE DE POMPE D'EAU	
POLEA CIGÜEÑAL		CRANKSHAFT PULLEY		PULIGGIA ALBERO MOTORE		POULIE VILEBREQUIN	
REF	OEM		Ø				
MP514693	33863 33863T	2	173 mm				
MP514720		2	6-3/4"				

POLEA BOMBA AGUA		WATER PUMP PULLEY		PULIGGIA POMPE DELL'ACQUA		POULIE DE POMPE D'EAU	
REF	OEM		Ø		BOMBA PUMP POMPA POMPE		
REC8M0153706 MP514516	8M0153706 807729T	V6 & V8 (SERPENTIN)	150 mm	2	REC46-8M0113734 REC46-8M0113735		

POLEA PLANA SERPENTÍN		IDLER PULLEY		PULIGGIA PIANA SERPENTINA		POULIE PLANE SERPENTINE	
REF	OEM						
REC896332057	896332057	CMD 2.8 DMQSD 2.8 CMQSD 4.2					

POLEA GUÍA DE CORREA SERPENTÍN		GUIDE PULLEY		PULIGGIA DI GUIDA		POULIE DE GUIDE	
REF	OEM		Ø				
REC8M6500024	8M6500024	V6 & V8	80,96 mm				

TENSOR CORREA SERPENTÍN		BELT TENSIONER		TENDINGHIA		TENDEUR DE COURROIE	
REF	OEM		Ø				
REC8M0111642 REC807757T	8M0111642 898101425 807757T	CMQSD 2.8/4.2 V6 & V8	3"				

TENSOR CORREA V6 & V8

V6 & V8
BELT TENSIONER

TENDICINGHIA V6 E V8

TENDEUR DE COURROIE
V6 ET V8

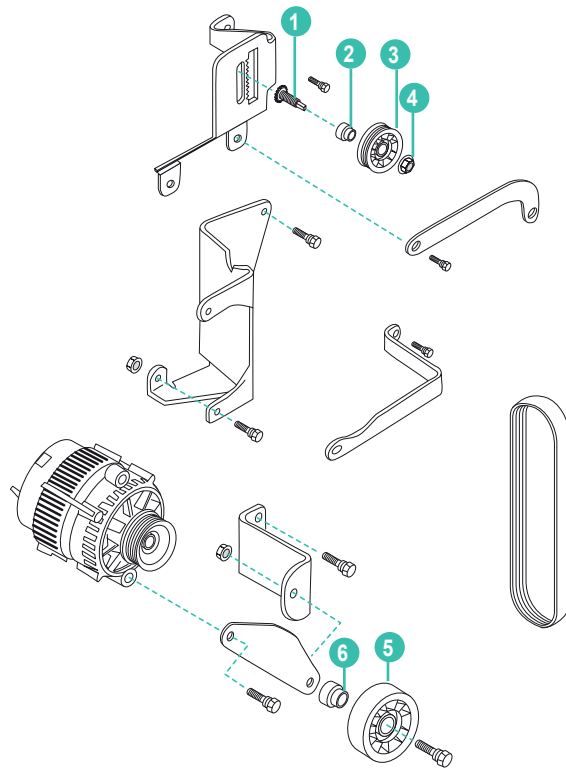

	REF	OEM				
1	REC8M0113182	8183812	PIÑÓN TENSOR	PINION STUD. SS	PIGNONE	PIGNON
2	REC865193	865193	CASQUILLO	BUSHING	BOCCOLA	BAGUE
3	REC864625T	864625T	POLEA	PULLEY (4.25" Ø)	PULEGGIA	POULIE
4	REC11-859135	859135	TUERCA	NUT	DADO	ÉCROU
5	REC8M6500024	865598	POLEA	PULLEY	PULEGGIA	POULIE
6	REC865193	865193	CASQUILLO	BUSHING	BOCCOLA	BAGUE

CORREAS

BELTS

CINGHIA

COURROIES

ALPHA

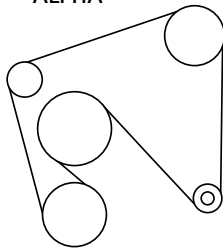

POWER STEERING

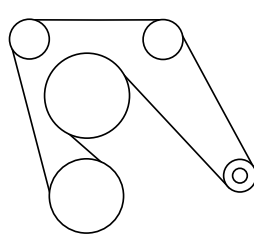

CLOSED COOLING

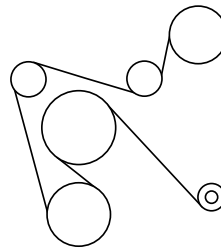

CLOSED COOLING &
POWER STEERING

BRAVO

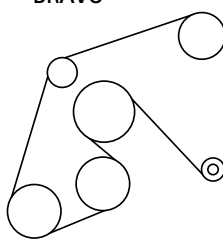

POWER STEERING

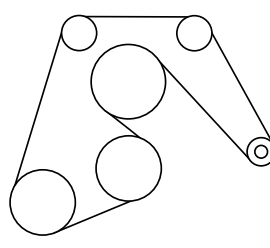

CLOSED COOLING

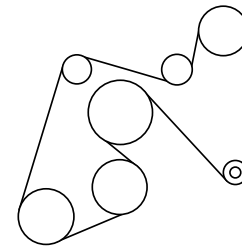

CLOSED COOLING &
POWER STEERING

**GUÍA DE CORREAS
BOMBA AGUA****V-BELTS GUIDE
WATER POMPE****GUIDA CINGHIA MOTORE
POMPA ACQUA****GUIDE DE COURROIES
POMPE A EAU**

	SERIE	ALTERN.	DIRECCIÓN POWER STEERING IDROGUIDA DIRECTION	BOMBA AGUA SALADA SEA WATER PUMP POMPA ACQUA SALATA POMPE A EAU
CMD 1.7MS 120 I/L4	8810800	RM57-862054Q	RM57-862054Q	
CMD 1.7MI 120 L/L4	88109041	RM57-862054Q	RM57-862054Q	
CMD QSD 2.0 2.0EI, ES			REC57-879150023	
CMD QSD 2.8 & 4.2			REC57-898101580	

**GUÍA DE CORREAS
BOMBA AGUA****V-BELTS GUIDE
WATER POMPE****GUIDA CINGHIA MOTORE
POMPA ACQUA****GUIDE DE COURROIES
POMPE A EAU**

	SERIE	ALTERN.	DIRECCIÓN POWER STEERING IDROGUIDA DIRECTION	BOMBA AGUA SALADA SEA WATER PUMP POMPA ACQUA SALATA POMPE EAU
110	63-66	1537370 - 2044033	REC57-49043A1	
120	64-73	1666601-3770649	REC57-49043A1	
120	74-82	3770650-6229717	REC57-49043A1	REC57-65607Q (37")
120	74-82	3770650-6229717	REC57-49043A1	REC3852106 (40")
120(2.5L)	82-89	6229718 - C853255	REC57-49043A1	
120(2.5L)	82-89	6229718 - C853255 W/P/S	REC3852106	REC57-65607Q
140	68-73	2508261-3770649	REC57-49043A1	
140	74-82	3770650-6229717	REC57-49043A1	REC57-65607Q (37")
140	74-82	3770650-6229717	REC57-49043A1	REC3852106 (40")
140/3.0L/3.0LX	1982	6229718	REC57-49043A1	
140/3.0L/3.0LX	1982	6229718+ W/P/S	REC3852106	REC57-65607Q
150	64-66	1666495-2048646	REC57-49043A1	
160	67-69	2048022-2770031	REC57-49043A1	
165	70-73	2770032 - 3774864	REC57-49043A1	
165	74-81	3774865 - 5813433	REC57-49043A1	REC57-65607Q (37")
165	74-81	3774865 - 5813433	REC57-49043A1	REC3852106 (40")
165/170/180/190/3.7L	85-89	6916779 - C762299	REC57-49043A1	REC57-49043A1
470 (170HP)	83-84	6218037 - 6916778	REC57-49043A1	REC57-49043A1
488	83-84	6170297 - 6916778	REC57-49043A1	REC57-49043A1
175	1987	0B527955-0B773242	REC57-816295Q	REC57-816295Q
175/185/4.3L	85-92	A331455 - D714106	REC3858462	REC57-34359 REC966903
3.0L GM 181 I/L4		OW302000+	RM57-862054Q	
3.0 MPI EC		1A072812+	RM57-862054Q	
3.0 TKS Pus		1G404114+	RM57-862054Q	
4.3L	92-96	D714107 - F802999	REC829207	REC57-13457Q
4.3L (2bbl)	88-32	0B773243-0D714106	REC57-816295Q	
4.3L (GenII) (2 bbl)	92-96	0D714107-0F802999	REC57-816295Q	
4.3LX (4bbl)	88-92	0B775130-0D714369	REC57-816295Q	
4.3LX (Gen II)	92-96	0D714370-0F802999	REC57-816295Q	
888	71-77	3108723 - 4887829	REC3858462	
888	71-77	3108723 - 4887829	REC3858462	REC57-13457Q (30") REC3858462
898 W/O HIGH MT P/S	77-84	4762210 - 6218461	REC829207	REC966900 REC966903
898 W/ HIGH MT P/S	77-84	4762210 - 6218461	REC3858462	REC57-91035Q1 REC966903
898/200/5.0L	85-95	6218462 - F600999	REC3858462	REC57-91035Q1 REC966903
898/200/5.0L	85-95	6218462 - F600999	REC829207	REC57-34359 REC57-13457Q
200	1969	2453769 - 2712072	REC57-49043A1	
205	85-91	A331455 - D714369	REC3858462	REC57-34359 REC966903
215	70-72	2781153 - 3563181	REC3858462	
215 MIE	70-72	2781153 - 3563181	REC3858462	
225	73-74	3385721 - 4166999	REC3858462	REC57-34359 REC966903
225 MIE	73-74	3385721 - 4166999	REC3858462	
225 MCM/MIE	67-69	2278647 - 2694014	REC829207	
228 W/O HIGH MT P/S	77-82	4765100-6218461	REC829207	REC966900 REC966903
228 W/ HIGH MT P/S	77-82	4765100-6218461	REC3858462	REC57-91035Q1 REC966903
228/230/5.0L	83-95	6218462 - F600999	REC3858462	REC57-91035Q1 REC966903
228/230/5.0L	83-95	6218462 - F600999	REC829207	REC57-34359 REC57-13457Q
228 MIE	1977	4765100 - 4929030	REC829207	REC966900
228/230/5.0L MIE	78-87	4929030 - B788151	REC3858462	REC57-91035Q1 REC966903
228/230/5.0L MIE	78-87	4929030 - B788151	REC829207	REC57-34359 REC57-13457Q
233	75-77	4173000 - 4902304	REC3858462	
233	75-77	4173000 - 4902304	REC3858462	REC57-13457Q REC966903
233 MIE	75-76	4173000 - 4775784	REC3858462	
250	68-69	2314301 - 2639854	REC829207	
250	1977	4768000 - 4908849	REC3858462	REC966903 REC966903
255 MCM/MIE	73-74	3258728 - 4175499	REC3858462	
255	75-76	4175500 - 4498700	REC829207	
255	1976	4498701-4499060	REC829207	
255	1976	4499061-4767999	REC829207	
255 MIE	75-77	4175500 - 4498700	REC829207	
255 MIE	77-78	4498701 - 4924564	REC829207	REC966903

		SERIE	ALTERN.	DIRECCIÓN POWER STEERING IDROGUIDA DIRECTION	BOMBA AGUA SALADA SEA WATER PUMP POMPA ACQUA SALATA POMPE EAU
255/260/5.7L MIE Et Ski	78-86	4924565 - B522505	REC3858462		REC966903
260/5.7L MIE Et Ski	87-93	B522506 - F024999	REC3858462		REC966903
260/5.7L MIE Et Ski	87-93	B522506 - F024999	REC829207		REC57-13457Q
5.7L MIE Et Ski	94-96	F025000 - K040306	REC829207		REC57-13457Q
260 W/HM P/S	78-82	4908850 - 6218461	REC3858462	REC57-91035Q1	REC966903
260 W/LM P/S	1978-82	4908850 - 6218461	REC829207		REC966903
260/5.7L	1983-95	6218462 - F600999	REC3858462	REC57-91035Q1	REC966903
260/5.7L	1983-95	6218462 - F600999	REC829207	REC57-34359	REC57-13457Q
5.7L/5.7LX	1996	F601000 - K001526	REC829207	REC57-816295Q	REC57-13457Q
350 MAG	1986-95	A635178 - F600999	REC3858462	REC57-34359	REC966903
350 MAG	1986-95	A635178 - F600999	REC829207		REC57-13457Q
350 MAG	1996	F601000 - K001500	REC829207		REC57-13457Q
350 MAG Ski	1991-96	D505450 - K040005	REC829207		REC57-13457Q
Black Scorpion Ski	1996	F800000 - K040000	REC829207		REC57-13457Q
270 MCM/MIE	1969-72	2851074 - 3385720	REC829207		
280	1975	4176250 - 4176468	REC829207		
280	1975-76	4176469 - 4499390	REC829207		
280	1976	4499391 - 4499780	REC829207		
280	1976	4499781 - 4770199	REC829207		
5.7L	1988-96	0B525982-0F600999		REC57-816295Q	
5.7LEFI (2bbl)	1996	0F752400-0K001505		REC57-816295Q	
5.7L Alpha EFI (TBI)	1995	0F355305-0F752389		REC57-816295Q	
5.7L Bravo EFI (TBI)	1995	0F225560-0F752399		REC57-816295Q	
5.7LX Bravo EFI (Gen+)	1996	0F800300-0K001508		REC57-816295Q	
5.7LX EFI (4bbl TBI)	1996	0F752400-0K001505		REC57-816295Q	
320(EFI)	1987-89	A543604 - C622418	REC3858462	REC57-34359	
325 MCM/MIE	1968-74	2278747 - 3780449	REC57-48122Q		
330	1977-81	4623115-6083144	REC57-78200Q1		REC966903
330	1982-87	6083144 - B816540	REC57-78200Q1	REC57-96834Q (50")	REC966903
330	1982-87	6083144 - B816540	REC57-78200Q1	REC966931 (55")	REC57-13457Q
340 (7.4L)	1981-92	5889914 - D715493	REC57-78200Q1		REC966903
340 (7.4L)	1981-92	5889914 - D715493	REC57-78200Q1		REC57-13457Q
350 MIE	1974-75	3780450-4501640	REC57-48122Q		
350 MIE	1976	4501641 - 4623109	REC57-48122Q		REC966903
350 Mag Alpha	1987-95	0B525982-0F600999		REC57-816295Q	
350Mag Alpha (4bbl)	1996	0F601000-0K001526		REC57-816295Q	
350Mag Alpha EFI (Gen+)	1996	0F800300-0K001508		REC57-816295Q	
350Mag Bravo MPI	1995	0F415189-0F601999		REC57-816295Q	
350Mag Bravo MPI (Gen+)	1996	0F602000-0K001500		REC57-816295Q	
7.4L BRAVO	1988-91	B771113 - D603117	REC57-78200Q1	REC966931	REC57-13457Q
7.4L BRAVO	1988-91	B771113 - D603117	REC57-48122Q		REC57-13457Q
7.4L/LX BRAVO	1992-97	D603118 - K999999	REC57-48122Q		REC3852106
7.4LX Bravo (TBI)	1996-97	F820000 - K999999	REC57-48122Q		REC57-13457Q
7.4LX Bravo (MPI)	1996-97	F602010 - K147349	REC57-48122Q		REC3852106
7.4LX Bravo (MPI)	1997	K147350 - K999999	REC57-48122Q		REC57-13457Q
7.4L MIE	1989-92	C391564 - D715493	REC57-78200Q1		REC57-13457Q
7.4L MIE	1989-92	C391564 - D715493	REC57-48122Q		REC57-13457Q
7.4L MIE	1992-97	C391564 - K999999	REC57-48122Q		REC3852106
454 MAG Alpha	1986-88	A631894 +	REC57-78200Q1	REC57-96834Q (50")	
454 MAG Alpha	1986-88	A631894+	REC57-78200Q1	REC966931 (55")	
454 MAG	1988-92	B721206 - D805068	REC57-78200Q1	REC966931	REC57-13457Q
454 MAG	1988-92	B721206 - D805068	REC57-48122Q		REC57-13457Q
454 MAG	1992-97	D805069 - K999999	REC57-48122Q		REC3852106
454 MAG (MPI)	1994-97	F115700 - K147349	REC57-48122Q		REC3852106
454 MAG (MPI)	1997	K147350 - K999999	REC57-48122Q		REC57-13457Q
454 MAG Ski	1995-97	F215800 - K999999	REC57-48122Q		REC3852106
370(TRS)	1978-85	4179554 - 6721527	REC57-48122Q		
370(TRS)	1985-87	6721528 - B714586	REC57-48122Q	REC57-96834Q	
390 MCM/MIE	1969-70	2781129 - 3042731	REC57-48122Q		
400 (TRS)	1980-86	4179554 - B457644	REC57-48122Q		
420/425	1987-92	A398941 - D725499	REC57-48122Q	REC57-96834Q	
420/425	1992	D725500 - D937011	REC57-48122Q		REC3852106
440 (TRS)	1983-86	4179554 - B485220	REC57-48122Q		
450	1995-96	F347100 - F347227	REC57-48122Q		REC3852106
460 (TRS)	1983-86	4179554 - 6181046	REC57-48122Q		
502 MAG	1990-97	C878221 - D824588	REC57-48122Q		REC57-13457Q
502 MAG	1990-97	C824589 - K999999	REC57-48122Q		REC3852106
502 MAG (MPI)	1994-97	D840650 - K147349	REC57-48122Q		REC3852106
502 MAG (MPI)	1997	K147350 - K999999	REC57-48122Q		REC57-13457Q
8.2L MIE	1990-93	C878221 - D857199	REC57-48122Q		REC57-13457Q
8.2L MIE	1993-97	D857200 - K999999	REC57-48122Q		REC3852106
8.2L MPI MIE	1996-97	F819620 - K147349	REC57-48122Q		REC3852106
8.2L MPI MIE	1997	K147350 - K999999	REC57-48122Q		REC57-13457Q

GUÍA DE CORREAS SERPENTIN

SERPENTINE BELTS GUIDE

GUIDA CINGHIA SERPENTINA MOTORE

GUIDE DE COURROIES SERPENTINES



REF	OEM	LARGO LENGHT LUNGHEZZA LONGUEUR	ANCHO WIDHT LARGHEZZA LARGE
REC57-865615Q03	57-865615Q03	270,4 cm	
REC57-865615Q04	57-865615Q04	194,1 cm	
REC57-865615Q06	57-865615Q06	266,7 cm	
REC57-865615Q07	57-865615Q07	246,7 cm	
REC57-865615Q08	57-865615Q08	253,5 cm	2.06 cm
REC57-807755Q04	57-807755Q04	224,0 cm	
REC57-807755Q05	57-807755Q05	193,0 cm	
REC57-861049Q	57-861049Q	264,9 cm	
REC57-861757Q	57-861757Q	247,1 cm	

REF	OEM	LARGO LENGHT LUNGHEZZA LONGUEUR	ANCHO WIDHT LARGHEZZA LARGE
REC57-861758Q	57-861758Q	219,7 cm	
REC57-861759Q	57-861759Q	235,2 cm	
REC57-865615Q01	57-865615Q01	283,0 cm	
REC57-865615Q02	57-865615Q02	228,5 cm	
REC57-865615Q05	57-865615005	223,3 cm	2.06 cm
REC57-865615Q10	57-865615010	219,5 cm	
REC57-817113	57-817113	138,9 cm	
REC57-8M0097728	57-8M0097728 57-8M0074767	171,3 cm	
REC57-8M0088876	57-8M0088876	168,7 cm	



		SERIE	REF	NOTA FOOTNOTE NOTA NOTE
4.3L Alpha	1996-99	OF803000-OL618999	REC57-807755Q05	4
4.3L Alpha	1996-99	OF803000-OL618999	REC57-861758Q	2, 6
4.3L Alpha	1996-99	OF803000-OL618999	REC57-861759Q	2, 5
4.3L Alpha	2000-04	OL619000 +	REC57-865615Q04	3, 6, 7
4.3L Alpha	2000-04	OL619000+	REC57-865615Q08	4, 5, 7
4.3L Alpha	2000-04	OL619000+	REC57-865615Q03	3
4.3L Bravo	1996-99	OF803000-OL618999	REC57-861049Q	2, 5
4.3L Bravo	1996-99	OF803000-OL618999	REC57-861757Q	2, 6
4.3L Bravo	2000-04	OL619000+	REC57-865615Q08	4, 7
4.3L Bravo	2000-04	OL619000+	REC57-865615Q03	3
4.5 Et 6.2L Bravo Raw system			REC57-8M0097728	
4.5 Et 6.2L Bravo Fresh system			REC57-8M0088876	
5.0L Bravo	2002-04	OM600000+	REC57-865615Q06	3, 5, 7
5.0L Alpha	1998-99	OL012052-OL618999	REC57-807755Q05	4, 6
5.0L Alpha	1998-99	OL012052-OL618999	REC57-861049Q	5
5.0L Alpha	1998-99	OL012052-OL618999	REC57-861758Q	2, 6
5.0L Alpha	2000-04	OL619000+	REC57-865615Q06	3, 6, 7
5.0L Alpha	2000-04	OM600000+	REC57-865615Q06	3, 5, 7
5.0L Alpha	2001-04	OL619000+	REC57-865615Q08	4, 5, 7
5.0L Alpha	2001-04	OL619000+	REC57-865615Q03	3
5.0L Bravo	1998-99	OL012052-OL618999	REC57-861049Q	2, 5
5.0L Bravo	1998-99	OL012052-OL618999	REC57-861757Q	2, 6
5.0L Bravo	2000-04	OL619000+	REC57-865615Q08	4, 7
5.0L Bravo	2000-04	OL619000+	REC57-865615Q03	3
350 Mag, Alpha	1997-04	OK001501-OL618999	REC57-807755Q05	4, 6
350 Mag, Alpha	1997-04	OK001501-OL618999	REC57-861049Q	2, 5
350 Mag, Alpha	1997-04	OK001501-OL618999	REC57-861758Q	2, 6
350 Mag, Alpha	2000-04	OL619000+	REC57-865615Q07	3, 6, 7
350 Mag, Alpha	2002-04	OM600000+	REC57-865615Q06	3, 5, 7
350 Mag, Alpha	2000-04	OL619000+	REC57-865615Q08	4, 5, 7
350 Mag, Alpha	2000-04	OL619000+	REC57-865615Q03	3
350 Mag, Bravo	1997-04	OK001501-OL618999	REC57-861049Q	2, 5
350 Mag, Bravo	1997-04	OK001501-OL618999	REC57-861757Q	2, 6
350 Mag, Bravo	2002-04	OM600000+	REC57-865615Q06	3, 5, 7
350 Mag, Bravo	2000-04	OL619000+	REC57-865615Q08	4, 7
350 Mag, Bravo	2000-04	OL619000+	REC57-865615Q03	3
5.7L Alpha	1997-99	OK001501-OL618999	REC57-807755Q05	4, 6
5.7L Alpha	1997-99	OK001501-OL618999	REC57-861049Q	2, 5
5.7L Alpha	1997-99	OK001501-OL618999	REC57-861758Q	2, 6
5.7L Alpha	2000-04	OL619000+	REC57-865615Q08	3, 6, 7
5.7L Alpha	2000-04	OL619000+	REC57-865615Q03	3
5.7L Alpha	2000-04	OM600000+	REC57-865615Q06	3, 5, 7
5.7L Alpha	2000-04	OL619000+	REC57-865615Q08	3, 6, 7

NOTA

- Usar con polea bomba de plástico Ø 4-3/4"
- Usar con polea bomba de metal Ø 4-3/4"
- Para motores con dirección hidráulica
- Para motores sin dirección hidráulica
- Para motores con circuito de refrigeración cerrado
- Para motores con refrigeración standard
- Para motores con alternadores montados en alto
- Intercambiador
- Alternador

FOOTNOTE

- Use w/ plastic 4-3/4" Ø p/s pump pulley
- Use with metal 5-3/4" Ø p/s pump pulley
- For engines with power steering
- For engines without power steering
- For engines with closed cooling
- For engines with standard cooling
- Engines with high mounted alternators
- Blower
- Alternator

		SERIE	REF	NOTA FOOTNOTE NOTA NOTE
5.7L Alpha	2000-04	OL619000+	REC57-865615Q03	3
5.7L Bravo	1997-99	OK001501-OL618999	REC57-861049Q	2, 5
5.7L Bravo	1997-99	OK001501-OL618999	REC57-861757Q	2, 6
5.7L Bravo	2002-04	OM600000+	REC57-865615Q06	3, 5, 7
5.7L Bravo	2000-04	OL619000+	REC57-865615Q08	4, 7
5.7L Bravo	2000-04	OL619000+	REC57-865615Q03	3
5.7L Ski	1997-02	K040004-M316999	REC57-807755Q04	
377 Scorpion MCM	1999-04	OL416146+	REC57-861757Q	
377 Scorpion Ski	1997-98	K000656+	REC57-807755Q04	
454 Mag MPI	1998-01	OL010029-OM024999	REC57-861049Q	1
454 Mag MPI	1998-01	OL010029-OM024999	REC57-865615Q06	2
454 Mag MPI	1998-01	OL010029-OM024999	REC57-865615Q07	4
454 Mag MPI Horizon MIE	1998-01	OL002200-OL674000	REC57-865615Q07	
496 Mag Et HO	2000-04	OM025000+	REC57-865615Q01	
500 EFI	1999-04	L001477+	REC57-807755Q04	
502 Mag MPI	1998-01	OL017000-OM024999	REC57-861049Q	1
502 Mag MPI	1998-01	OL017000-OM024999	REC57-865615Q07	4
502 Mag MPI	1998-01	OL017000-OM024999	REC57-865615Q06	2
525 EFI	2003-04	OM900146+	REC57-865615Q02	
525 SC	1991-96	OD456000-745215	REC57-817113	
575 SCI	2000-04	OL306696+	REC57-807755Q04	9
575 SCI	2000-04	OL306696+	REC57-817113	8
600 SC	1991-96	OD456489 - OF877462	REC57-817113	
600 SC	1998	OK000227+	REC57-817113	
7.4L MPI	1998-01	OL010003-OM024330	REC57-861049Q	1
7.4L MPI	1998-01	OL010003-OM024330	REC57-865615Q06	2
7.4L MPI	1998-01	OL010003-OM024330	REC57-865615Q07	4
7.4L MPI MIE	1998-01	OL002006-OM025999	REC57-865615Q07	
Black Scorpion Ski	1997-01	K040004-M316999	REC57-807755Q04	
MX 6.2L Black Scorpion Ski	2001	L670015-M391599	REC57-807755Q04	
MX 6.2L MPI	2002-04	OM600000+	REC57-865615Q06	3, 5
MX 6.2L MPI	2000-04	OL680003+	REC57-865615Q08	4, 7
MX 6.2L MPI Horizon	2002-04	OM600000+	REC57-865615Q06	3
MX 6.2L MPI Horizon	2001-04	OM300000+	REC57-865615Q08	4
MX 6.2L MPI Horizon MIE	2001	M300000-M310099	REC57-807755Q04	
MX 6.2L MPI MIE Et HO	1999-01	L670000-M310099	REC57-807755Q04	
8.1S MPI MIE Et HO	2000-04	OM025000+	REC57-865615Q02	
8.2L MPI MIE	1998-01	OL002450-OL674200	REC57-865615Q07	

NOTA

- Usare con puleggia pompa in plastica Ø 4-3/4"
- Usare con puleggia pompa in metallo Ø 4-3/4"
- Per motori con pompa idroguida
- Per motori senza pompa idroguida
- Per motori con circuito d'acqua chiuso
- Per motori con circuito aperto
- Per motori con alternatori montati nella parte superiore
- Scambiatore
- Alternatore

NOTA

- Utilisation avec poulie de pompe en plastique Ø 4-3/4"
- Utilisation avec poulie de pompe métallique Ø 4-3/4"
- Pour les moteurs avec direction hydraulique
- Pour les moteurs sans direction hydraulique
- Pour les moteurs avec circuit de refroid. fermé
- Pour les moteurs avec refroid. standard
- Pour les moteurs avec alternateurs montés en tête
- Echangeur
- Alternateur

**GUÍA DE CORREAS SERPENTIN****SERPENTINE BELTS GUIDE****GUIDA CINGHIA SERPENTINA MOTORE****GUIDE COURROIES SERPENTIN**

	REF	OEM	
CMD / D1.7L	REC57-882531	57-882531 57-882531T	ALT
CMD QSD 2.0 115/130/150/170	REC57-879172120	57-879172120	
CMD QSD 2.8 170/210/220/230	REC57-879194425	57-879194425 57-898101624	
CMD QSD 4.2 270/320/350	REC57-898101579	57-898101579	
TDI 3.0L V6	REC57-8M0093495	57-8M0093495 8M0067268	ALT & POWER STEERING

GUÍA DE CORREAS MOTOR**V-BELTS GUIDE****GUIDA CINGHIA MOTORE****GUIDE COURROIES DE MOTEUR**

REF	OEM
REC57-13457Q	57-13457Q
REC966931	57-13458Q
REC3852106	57-32850 57-69143Q
REC57-34359	57-34359 57-37619T, Q
REC57-36356	57-36356
REC3858462	57-45856 57-49213A1
REC829207	57-93658Q
REC57-48122Q	57-48120Q1
	57-48122Q

REF	OEM
REC57-49043A1	57-49043A1 57-64032Q1
REC57-64416	57-49211 57-64416
REC57-52692	57-52692
REC57-65607Q	57-65607T 940 mm
REC966903	57-74271Q
REC966900	57-77274
REC57-78200Q1	57-78200Q1
REC57-816295Q	57-816295Q
REC57-91035Q1	57-91035Q1

**MANGUITOS DE MOTOR HOSES****MANICOTTO MOTORE****TUYAU MOTEUR****TOMA DE AGUA****WATER SYSTEM****PRESA ACQUA****ENTRÉE D'EAU**

REF	OEM	Ø	
REC32-4172533	32-4172533 32-8M0062309	3/4"	13 ^{7/8} "
REC32-32461	32-32461 32-32461A1	5/8"	13 ^{7/8} "



REF	OEM	
REC32-43437	32-43437	Bravo Design I



REF	OEM	
REC32-52481	32-52481	GM 4 & 6 CYL Inline

















REF	OEM	
REC8M0062102	32-8M0062102	Bravo Design II

**CULATA --> COLECTOR ESCAPE****CYLINDER HEAD --> EXHAUST MANIFOLD****TESTATA --> COLLECTORE DI SCARICO****CUJASSE --> COLLECTEUR D'ÉCHAPPEMENT**

REF	OEM	
REC32-89653	32-89653	1 1/4" ID 5"



BOMBA DE AGUA	WATER PUMP	POMPA ACQUA	POMPE D'EAU												
<table border="1"> <tr><th>REF</th><th>OEM</th></tr> <tr><td>RM32-805375</td><td>32-805375</td></tr> </table> 	REF	OEM	RM32-805375	32-805375		<table border="1"> <tr><th>REF</th><th>OEM</th></tr> <tr><td>REC32-33189</td><td>32-33189</td></tr> </table>  <table border="1"> <tr><th>REF</th><th>OEM</th></tr> <tr><td>REC32-897181</td><td>32-897181</td></tr> </table> 	REF	OEM	REC32-33189	32-33189	REF	OEM	REC32-897181	32-897181	
REF	OEM														
RM32-805375	32-805375														
REF	OEM														
REC32-33189	32-33189														
REF	OEM														
REC32-897181	32-897181														
BOMBA DE AGUA --> ENFRIADOR DE ACEITE	MOLDED SEAWATER PUMP --> OIL COOLER	POMPA DELL' ACQUA --> SCAMBIATORE DELL'OLIO	POMPE D'EAU --> ÉCHANGEUR D'HUILE												
<table border="1"> <tr><th>REF</th><th>OEM</th></tr> <tr><td>REC32-88795</td><td>32-88795</td></tr> </table> 	REF	OEM	REC32-88795	32-88795		<table border="1"> <tr><th>REF</th><th>OEM</th></tr> <tr><td>REC32-860205</td><td>32-860205</td></tr> </table> 	REF	OEM	REC32-860205	32-860205					
REF	OEM														
REC32-88795	32-88795														
REF	OEM														
REC32-860205	32-860205														
<table border="1"> <tr><th>REF</th><th>OEM</th></tr> <tr><td>REC32-887952</td><td>32-887952</td></tr> </table> 	REF	OEM	REC32-887952	32-887952		<table border="1"> <tr><th>REF</th><th>OEM</th></tr> <tr><td>REC32-8080441</td><td>32-808044-1</td></tr> </table> 	REF	OEM	REC32-8080441	32-808044-1					
REF	OEM														
REC32-887952	32-887952														
REF	OEM														
REC32-8080441	32-808044-1														
ENFRIADOR DE ACEITE --> ENFRIADOR DE ACEITE	OIL COOLER --> OIL COOLER	SCAMBIATORE DELL'OLIO --> SCAMBIATORE DELL'OLIO	REFROIDISSEUR D'HUILE--> REFROIDISSEUR D'HUILE												
<table border="1"> <tr><th>REF</th><th>OEM</th></tr> <tr><td>REC32-8600891</td><td>32-8600891</td></tr> </table> 	REF	OEM	REC32-8600891	32-8600891											
REF	OEM														
REC32-8600891	32-8600891														
TRANSOM --> ENFRIADOR DE ACEITE	TRANSOM --> OIL COOLER	TRANSOM --> SCAMBIATORE DELL'OLIO	TRANSOM --> REFROIDISSEUR D'HUILE												
<table border="1"> <tr><th>REF</th><th>OEM</th></tr> <tr><td>REC32-807661</td><td>32-807661</td></tr> </table> 	REF	OEM	REC32-807661	32-807661		<table border="1"> <tr><th>REF</th><th>OEM</th></tr> <tr><td>REC32-96246A4</td><td>32-96246A4</td></tr> </table> 	REF	OEM	REC32-96246A4	32-96246A4					
REF	OEM														
REC32-807661	32-807661														
REF	OEM														
REC32-96246A4	32-96246A4														
ENFRIADOR --> CUERPO DE TERMOSTATO	COOLER --> THERMOSTAT HOUSING	SCAMBIATORE --> CORPO TERMOSTATO	REFROIDISSEUR --> CORPS THERMOSTAT												
<table border="1"> <tr><th>REF</th><th>OEM</th></tr> <tr><td>REC32-806856</td><td>32-806856</td></tr> </table> 	REF	OEM	REC32-806856	32-806856		<table border="1"> <tr><th>REF</th><th>OEM</th></tr> <tr><td>RM32-806209-1</td><td>32-806209-1</td></tr> </table> 	REF	OEM	RM32-806209-1	32-806209-1					
REF	OEM														
REC32-806856	32-806856														
REF	OEM														
RM32-806209-1	32-806209-1														
<table border="1"> <tr><th>REF</th><th>OEM</th></tr> <tr><td>REC32-807407</td><td>32-807407</td></tr> </table> 	REF	OEM	REC32-807407	32-807407		<table border="1"> <tr><th>REF</th><th>OEM</th></tr> <tr><td>REC32-16012</td><td>32-16012</td></tr> </table> 	REF	OEM	REC32-16012	32-16012					
REF	OEM														
REC32-807407	32-807407														
REF	OEM														
REC32-16012	32-16012														
<table border="1"> <tr><th>REF</th><th>OEM</th></tr> <tr><td>REC32-808033</td><td>32-808033</td></tr> </table> 	REF	OEM	REC32-808033	32-808033											
REF	OEM														
REC32-808033	32-808033														

**CUERPO TERMOSTATO
--> COLECTOR ESCAPE
ESTRIBOR**

REF	OEM
REC32-871171	32-87117 1 32-87117



**THERMOSTAT HOUSING
--> STARBOARD
EXHAUST MANIFOLD**

REF	OEM
REC32-807697	32-807697



REF	OEM
REC32-897401	32-897301



**CORPO TERMOSTATO -->
COLLETTORE SCARICO
DESTRO**

REF	OEM
REC32-8066351	32-8066351



REF	OEM
RM32-861057	32-861057



REF	OEM
REC32-8066361	32-8066361



**CORPS THERMOSTAT -->
COLLECTEUR EPUISEUR
TRIBORD**

**CUERPO TERMOSTATO
--> COLECTOR ESCAPE
BABOR**

REF	OEM
REC32-160211	32-16021 1



**THERMOSTAT HOUSING
--> PORT EXHAUST
MANIFOLD**

REF	OEM
REC32-33220	32-33220 32-3322070 32-8M0062614



**CORPO TERMOSTATO -->
COLLETTORE SCARICO
SINISTRO**

REF	OEM
REC32-52481	32-52481



REF	OEM
REC32-862124	32-862124



REF	OEM
RM32-860144	32-860144



REF	OEM
REC32-897491	32-89749-1



**CORPS THERMOSTAT
--> COLLECTEUR EPUISEUR
BABORD**

REF	OEM
REC32-862139	32-862139



REF	OEM
RM32-860331	32-860331



**CUERPO TERMOSTATO
--> COLECTOR
DELANTERO**

**THERMOSTAT HOUSING
--> FRONT MANIFOLD**

**CORPO TERMOSTATO -->
COLLETTORE FRONTALE**

**CORPS THERMOSTAT -->
COLLECTEUR FRONTAL**

REF	OEM
REC32-48132	32-48132



GUÍA MANGUITOS (COLA)

**HOSES FUEL GUIDE
(STERN DRIVES)**

**GUIDA MANICOTTO
(PIEDE)**

**GUIDE DE LA DOUILLE
(EMBASES)**

MOD	SERIE	TERMOS. --> BOMBA THERMOS. --> PUMP THERMOS. --> POMPA THERMOS. --> POMPE	ESTRIBOR STB DESTRO TRIBORD	TERMOS. --> COLECTOR. THERMOS. --> MANIFOLD THERMOS. --> COLLETTORE THERMOS. --> COLLECTEUR			TRANSOM TRANSOM TRANSOM TRANSOM	ENFRIADOR ACEITE OIL COOLER SCAMBIATORE DELL'OLIO REFROIDISSEMENT D'HUILE	
				BABOR PORT SINISTRO BABORD	ESCAPE EXHAUST SCARICO ÉCHAPPEMENT	TERMOSTATO THERMOSTAT THERMOSTATO THERMOSTAT		BOMBA WATER PUMP POMPA POMPE	
120	1666601-3377340	REC32-8M0071007				REC32-52481			
120	3377341-5192048	REC32-8M0071007				REC32-52481			
120	5192049-6229717	REC32-8M0071007				REC32-52481			
120/2,5L	6229718-0B531853	REC32-8M0071007				REC32-52481			
140	2508261-3332137	REC32-8M0071007				REC32-52481			
140	3332138-5157669	REC32-8M0071007				REC32-52481			
140	5157669-6229717	REC32-8M0071007				REC32-52481			
140/3.0L	6229718-0C856558	REC32-8M0071007				REC32-52481			
3.0L/LX	0C856559-0F603999	REC32-8M0071007				REC32-52481			
3.0LX	0G604000+	REC32-8M0071007				REC32-52481			
140	1538930-1725960	REC32-8M0071007				REC32-52481			
488 (4bbl)	6170297-6916778							REC32-33220	
190 (4bbl)	6916779							REC32-33220	
180/3.7LX (4bbl)	6916779							REC32-33220	
185 (4bbl)	6330183-6919655	REC32-33189							
165	2770032-5178958					REC32-52481			
165	5178959-5813433					REC32-52481			
185 (2bbl)	0A331455-0B527954	REC32-33189						REC32-33220	
175/4.3 (2bbl)	0B527955-0D714106	REC32-33189						REC32-33220	
4.3L (GEN II) (2bbl)	0D714107-0F00877	REC32-33189	REC32-871171	REC32-160211				REC32-806856	
4.3L (GEN II) (2bbl)	0F000878-0F601126		REC32-8066361	REC32-8066351		REC32-806856			
4.3L (GEN II) (2bbl)	0F601127-0F802999	REC32-33189	REC32-8066361	REC32-8066351		REC32-806856			REC27-68714A6
4.3LX (GEN+) (2bbl)	0F803000+	REC32-33189	REC32-807697	RM32-860144				REC32-16012	REC27-68714A6
205 (4bbl)	0A331455-0B527954	REC32-33189	REC32-871171					REC32-16012	
205/4.3LX (4bbl)	0B527955-0D714639	REC32-33189						REC32-16012	
4.3L (GEN II) (2bbl)	0D714370-0F001219	REC32-33189				REC32-807661	REC32-16012		
4.3L (GEN II) (2bbl)	0F001220-0F601126	REC32-33189	REC32-8066361	REC32-8066351	REC32-807661	REC32-16012			
4.3L (GEN II) (2bbl)	0F601127-0F802999	REC32-33189	REC32-8066361	REC32-8066351	REC32-807661	REC32-16012			
4.3LX (GEN+) (4bbl)	0F803114+	REC32-33189	REC32-807697	RM32-860144		REC32-807661	REC32-16012	REC32-860205	
200	2453769-2712072					REC32-52481			
225 (4bbl)	3385721-4166999	REC32-33189							
225-S (4bbl)	3385721-416999	REC32-33189							
200 (2bbl)	6218462-0B525981	REC32-33189	REC32-871171	REC32-160211		REC32-96246A4	REC32-806856	REC32-887952	REC27-68714A6
200/5.0L (2bbl)	0B525982-0F600999	REC32-33189	REC32-8066361	REC32-8066351	REC32-96246A4	REC32-806856	REC32-887952		
230 (4bbl)	6218462-0B525981	REC32-33189	REC32-871171	REC32-160211		REC32-96246A4	REC32-806856	REC32-887952	REC27-68714A6
230/5.0LX (4bbl)	0B525982-0F600999	REC32-33189	REC32-8066361	REC32-8066351	REC32-96246A4	REC32-806856	REC32-887952		
250	4768000-4908849	REC32-33189	REC32-871171						
260	6218462-0B525981	REC32-33189				REC32-96246A4	REC32-806856	REC32-887952	REC27-68714A6
260	6218462-0B525981	REC32-33189				REC32-96246A4			
260/5.7L	0B525982-0F600999	REC32-33189	REC32-8066361	REC32-8066351	REC32-96246A4	REC32-806856	REC32-887952		
5.7 ALPHA (2bbl)	0F601000+	REC32-33189	REC32-8066361	REC32-8066351	REC32-807661	REC32-806856	REC32-887952		
5.7L ALPHA (EF) TBI	0F355305-0F752399	REC32-33189	REC32-8066361	REC32-8066351	REC32-96246A4	REC32-806856	REC32-887952		
5.7L ALPHA (2bbl. -TBI)	0F752400+	REC32-33189	REC32-8066361	REC32-8066351	REC32-807661	REC32-806856	REC32-887952		
5.7LX ALPHA (4bbl)	0F601000+	REC32-33189	REC32-8066361	REC32-8066351		REC32-806856	REC32-887952		
5.7LX ALPHA (4bbl. -TBI)	0F752400+	REC32-33189	REC32-807697	REC32-8066351		REC32-806856	REC32-887952		
5.7L BRAVO	0B525982-0F600999								REC32-887952
5.7L BRAVO (2bbl)	0F601000+								REC32-887952
5.7L BRAVO (EF) TBI	0F225560-0F752399		REC32-8066361	REC32-8066351		REC32-96246A4	REC32-806856	REC32-887952	
5.7L BRAVO (2bbl. -TBI)	0F752400+	REC32-33189	REC32-807697	REC32-8066351					REC32-887952

MOD	SERIE	TERMOS. --> BOMBA THERMOS. --> PUMP TERMOS. --> POMPA THERMOS. --> POMPE	ESTRIBOR STB DESTRO TRIBORD	BATOR PORT SINISTRO BABORD	ESCAPE EXHAUST SCARICO ÉCHAPPEMENT	ENFRIADOR ACEITE OIL COOLER SCAMBIATORE DELL'OLIO REFROIDISSEMENT D'HUILE		
						TRANSOM TRANSOM TRANSOM TRANSOM	TERMOSTATO THERMOSTAT TERMOSTATO THERMOSTAT	BOMBA WATER PUMP POMPA POMPE
5.7LX BRAVO (4bb)	0F601000+		REC32-8066361	REC32-8066351				REC32-887952
5.7LX BRAVO (4bb)-TBI)	0F752400+	REC32-33189	REC32-807697	REC32-8066351				REC32-887952
5.7LX BRAVO (TBI)(GEN +)	0F800300+	REC32-33189	REC32-8066351	REC32-8066351			REC32-806856	REC32-887952
350 Mag. ALPHA	0A635178-0B525981	REC32-33189	REC32-871171	REC32-160211		REC32-96246A4		REC32-887952
350 Mag. ALPHA	0B525982-0F600999	REC32-33189	REC32-8066361	REC32-8066351		REC32-96246A4	REC32-806856	REC32-887952
350 Mag. ALPHA (4bb)	0F601000+	REC32-33189	REC32-8066361	REC32-8066351		REC32-807661	REC32-806856	REC32-887952
350 Mag. ALPHA (TBI) (Gen+)	0F800300+	REC32-33189	REC32-8066361	REC32-8066351		REC32-807661	REC32-806856	REC32-887952
350 Mag. BRAVO (MPI)	0F415189-0F601999	REC32-33189	REC32-8066361	REC32-8066351		REC32-807661	REC32-806856	REC32-887952
350 Mag BRAVO (MPI)(GEN+)	0F602000+	REC32-33189	REC32-8066361	REC32-8066351		REC32-807661	REC32-806856	REC32-887952
270	2851074-3385720							
300 TEMPEST	6668677-0B430367	REC32-33189				REC32-96246A4		
320 (EFI)	0A543604-0B157602	REC32-33189				REC32-96246A4		
320 (EFI)	0B157603-0C622418	REC32-33189				REC32-96246A4		
325	2278747-3780449				REC32-48132			
330	4623115-6083144				REC32-48132			
330	6083145-0B816540			REC32-897491				
7.4L BRAVO	0B771113-0D603117		REC32-52481	REC32-897491				
7.4LX BRAVO (Gen.V)	0D603118-0F800699	REC32-897181		REC32-897491				
7.4LX BRAVO (MP)	0F602010+	REC32-897181	REC32-807697	REC32-897491				
450 Mag. ALPHA	0A631894-0B785148					REC32-96246A4		
454 Mag. BRAVO	0B721206-0D805068			REC32-897491				
454 Mag. BRAVO (Gen.V)	0D805069-0F304999	REC32-897181	REC32-807697	REC32-897491				
454 Mag. BRAVO (Gen.V)	0F305000-0F801699	REC32-897181		REC32-897491				
454 EFI (Gen.V)	0F115700-0F802349	REC32-897181						
370TRS	4179554-6721527				REC32-48132			
370TRS	6721528-0B714586		REC32-807697	REC32-897491				
400TRS	4179554-0B457644				REC32-48132			
420	0A398941-0B622418	REC32-897181						
425	0A398941-0B622418	REC32-897181						
425 (Gen.V)	0A398941-0B622418	REC32-897181						
440TRS	4179554-0B485220				REC32-48132			
450 (Gen.V)	0F347100-0F615761	REC32-897181		REC32-897491				
460 TRS	4179554-6181046				REC32-48132			
465	0C84992-0F213244	REC32-897181						
465 (Gen.V)	0C84992-0F213244	REC32-897181						
500 (Gen.V)	0F213293+	REC32-897181		REC32-897491				
502 Mag. BRAVO	0C878221-0D824588	REC32-897181		REC32-897491				
502 Mag. BRAVO (Gen.V)	0D824589-0F114528	REC32-897181		REC32-897491				
502 EFI (Gen.V)	0D840650-0F802599	REC32-897181		REC32-897491				

GUÍA MANGUITOS HOSES FUEL GUIDE GUIDA MANICOTTO GUIDE TUYAUX



MOD	SERIE	TERMOS. --> BOMBA THERMOS. --> PUMP TERMOS. --> POMPA THERMOS. --> POMPE
530D-TA(BRAVO)	0B993002-0D725151	RM32-805375
D183 Turbo AC (BRAVO)	0B993002-0D725151	RM32-805375
D3.0L (BRAVO)	0D725152+	RM32-805375
636D-TA (BRAVO)	0B993002-0D850127	RM32-805375
D219 Turbo AC (BRAVO)	0B993002-0D850127	RM32-805375
D3.6L (BRAVO)	0D850128+	RM32-805375
D4.2L (BRAVO)	0D554732+	RM32-805375
D3.0L	0D725152+	RM32-805375

**GUÍA MANGUITOS
(EJE - GASOLINA)**
**HOSES FUEL GUIDE
(SHAFT - FUEL)**
**GUIDA MANICOTTO
(ASSE - BENZINA)**
**GUIDE TUYAUX
(ARBRE - ESSENCE)**

MOD	SERIE	TERMOS. --> BOMBA THERMOS. --> PUMP TERMOS. --> POMPA THERMOS. --> POMPE	TERMOS. --> COLECTOR. THERMOS. --> MANIFOLD TERMOS. --> COLLETORE THERMOS. --> COLLECTEUR			ENFRIADOR ACEITE OIL COOLER SCAMBIATORE DELL'OLIO REFROIDISSEMENT D'HUILE		
			ESTRIBOR STB DESTRO TRIBORD	BABOR PORT SINISTRO BABORD	ESCAPE EXHAUST SCARICO ÉCHAPPEMENT	TRANSOM TRANSOM TRANSOM TRANSOM	TERMOSTATO THERMOSTAT TERMOSTATO THERMOSTAT	BOMBA WATER PUMP POMPA POMPE
198 MIE (2bbl.)	4762210-6218461	REC32-33189			REC32-48132			
228 MIE (4bbl.)	4765100-5170008	REC32-33189			REC32-48132			
228 MIE (4bbl.)	5170009-5907057	REC32-33189						
230 MIE (4bbl.)	5907058-0B522505	REC32-33189			REC32-48132		REC27-68714A6	
230/5.0L MIE (4bbl.)	0B522506-0B788151	REC32-33189			REC32-48132		REC27-68714A6	
225MIE	2278647-2694014				REC32-33189			
250 MIE	2314301-2639854	REC32-33189			REC32-33189			
255 MIE	4175500-5195908	REC32-33189			REC32-33189			
255 MIE	5195909-5907057	REC32-33189			REC32-48132			
260 MIE	5900758-0B522505	REC32-33189			REC32-48132		REC27-68714A6	
260/5.7 MIE	0B522506-0F024999	REC32-33189			REC32-48132		REC27-68714A6	
5.7L MIE	0F025000+	REC32-33189	REC32-871171		REC32-33189	REC32-806856		
5.7L (SKI) MIE	0A338533-0B514626	REC32-33189						
5.7L (COMP. SKI)	0B514627-0F775199	REC32-33189	REC32-871171					
5.7L (COMP. SKI) (2bbl.)	0F775200+	REC32-33189	REC32-8066361	REC32-8066351		REC32-806856		
350 Mag. (SKI) CARB	0D505450+	REC32-33189	REC32-871171			REC32-806856	REC32-860205	
350 Mag. (SKI) (9EFI)TBI	0F215561+	REC32-33189	REC32-8066361	REC32-8066351		REC32-806856	REC32-860205	
350 Mag. (SKI) (9EFI)MPI	0F350583+	REC32-33189	REC32-8066361	REC32-8066351			REC32-860205	
BLACK SCORPION (GEN+)	0F800000+		REC32-807697	REC32-8066351		REC32-806856	REC32-860205	REC32-8600891
270 MIE	2851074-3077735	REC32-33189						
325 MIE	2278747-3780449				REC32-48132			
330 MIE	4623115-5889913				REC32-48132			
7.4L MIE w/hurth	0C391564-0D715493	REC32-897181		REC32-897491				
7.4L MIE (Ih) Gen.V	0D715494-0F820141	REC32-897181		REC32-897491				
7.4L EFI MIE (LH) Gen.V	0F563052-0F820103	REC32-897181						
390 MIE	2781129-2820559				REC32-48132			
8.2L MIE w/hurth	0C878221-0D857199	REC32-897181		REC32-897491				
8.2L MIE (Gen.V)	0D857200-0F819619	REC32-897181		REC32-897491				

PARTES DEL MOTOR ENGINE PARTS

PARTI MOTORE PIECES MOTEUR

JUNTAS PARA BASES GM Y FORD

Los Kits están diseñados y catalogados específicamente para aplicaciones marinas. Su calidad es superior a las juntas originales.

MARINE GASKETS TO GM & FORD ENGINES

The gaskets kits are designed and cataloged specifically for marine engine applications. Their quality is even better than the oem's.

GUARNIZIONI PER MOTORI GM E FORD



I kit di guarnizioni sono disegnati e fabbricati specificatamente per applicazioni marine. La qualità è assolutamente paragonabile a quelle originali.

JOINTS POUR MOTEURS GM ET FORD

Les kits sont spécifiquement conçus et catalogués pour les applications marines. Leur qualité est supérieure à celle des joints d'origine.



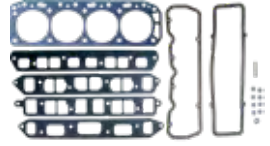



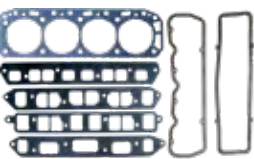
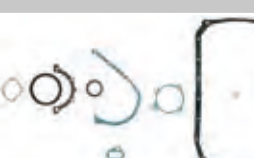

SERIE SERIAL				
1700-17099	KIT JUNTAS DE CULATA (pack individual)	CYLINDER HEAD GASKET (single-packed)	GUARNIZIONI TESTATA (quantità 1)	KIT JOINTS DE CULASSE (paquet individuel)
17100-17199	JUEGOS DE CONVERSIÓN Todas las juntas y retenes de aceite que no se encuentran en los juegos de culata. Incluye las juntas del cárter y los retenes.	CONVERSION KITS All gaskets and oil seals not found in a Head Set. This includes timing cover gaskets and seals, oil pan gaskets, and rear main bearing seals.	KIT PARTE BASSA Include tutte le guarnizioni ed i paraoli della parte bassa del motore, viene fornita anche la guarnizione della coppa dell'olio.	KITS DE CONVERSION Tous les joints d'étanchéité et joints d'huile qui ne sont pas contenus dans les kits de culasse. Comprend les joints de carter et les joints d'huile.
17200-17299	KIT DE DESCARBONIZACIÓN Todas las juntas y retenes necesarios para el trabajo de las válvulas, incluyendo la culata, la tapa de la válvula y juntas de colector de admisión y colector de escape. (Los juegos de 4 cyl no contienen las juntas del colector de admisión/escape. Deben pedirse por separado).	HEAD SETS SERIES All gaskets and seals necessary for a valve grinding job, including cylinder head gaskets, valve cover gaskets, intake & exhaust manifold gaskets (except 4 cyl intake set), and valve stem seals.	KIT PARTE ALTA (SMERIGLIO) Include tutte le guarnizioni ed i paraoli della parte alta del motore, testate, carter distribuzione, aspirazione e scarico. (Motori a 4 cyl. la guarnizione aspirazione è da ordinare separatamente).	KIT DE DÉCARBONISATION Tous les joints requis pour le travail sur les soupapes, y compris les joints de culasse, de couvercle de soupape, de collecteur d'admission et d'échappement (les kits 4 cylindres ne contiennent pas de joints de collecteur d'admission/échappement). Ils doivent être commandés séparément.
17300-17399	KIT DE COLECTOR DE ADMISIÓN Juntas de la parte de admisión del colector, retenes y juntas de la base del distribuidor.	INTAKE MANIFOLD SETS Intake manifold side gaskets, intake manifold end seals, and distributor mounting gasket.	KIT GUARNIZIONE ASPIRAZIONE Guarnizioni laterali del collettore di aspirazione, guarnizioni e guarnizioni della base del distributore.	KIT DE COLLECTEUR D'ADMISSION Joints de collecteur d'admission, joints d'étanchéité et joints de base de distributeur.
17400-17499	KIT DE COLECTOR DE ESCAPE (de colector a culata)	EXHAUST MANIFOLD (manifold-to-cylinder head gaskets)	KIT GUARNIZIONE SCARICO (dalla testata al collettore)	KIT COLLECTEUR D'ÉCHAPPEMENT (collecteur à la culasse)
17700-17749	KIT DE CONTRARROTACIÓN RETÉN TRASERO DEL CIGÜENAL Retenes traseros del cigüeñal diseñados para motores de rotación opuesta a la normal. (Retenes de rotación normal incluidos en el set de conversión)	REVERSE ROTATION REAR MAIN BEARING SEAL SETS Rear main bearing seals designed to seal a crankshaft which rotates in the opposite direction from normal (Standard rotation seal is included in conversion set)	PARAOLIO MOTORI CONTROROTANTI ALBERO MOTORE Nei motori rotazione STD il paraolio viene già incluso nel kit della parte bassa. (Guarnizioni a rotazione normale incluse nel set di conversione)	KIT CONTRE-ROTATION JOINTS D'HUILE DE VILEBREQUIN ARRIÈRE Joints de vilebrequin arrière conçus pour les moteurs à contre-rotation (joints à rotation normale inclus dans le kit de conversion).
17750-17799	KIT DE RETENES TAPA DEL CIGÜENAL DE CONTRARROTACIÓN Retenes de la tapa del cigüeñal diseñados para motores de rotación opuesta a la normal. (Retenes de rotación normal incluidos en el set de conversión).	REVERSE ROTATION TIMING COVER SEAL SETS SERIES Timing cover seals designed to seal crankshaft which rotates in the opposite direction from normal (standard rotation seal is included in Conversion set and Timing cover set)	PARAOLIO CARTER DISTRIBUZIONE CONTROTOTANTI Guarnizioni del coperchio dell'albero a gomiti progettate per motori controrotanti (le guarnizioni per la rotazione normale sono incluse nel set di conversione).	KIT DE JOINTS DE COUVERCLE DE VILEBREQUIN CONTRE-ROTATIF Joints de couvercle de vilebrequin conçus pour les moteurs à contre-rotation (joints à rotation normale inclus dans le kit de conversion).
17900-17949	KIT DE TAPA VÁLVULA Todas las juntas de las tapas de las válvulas para sellar el motor.	VALVE COVER SET SERIES All valve cover or push rod cover gaskets (and grommets if required) required to seal one engine.	KIT COPERCHIO PUNTERIE Tutte le guarnizioni del coperchio della valvola per sigillare il motore.	KIT DE COUVERCLE DE SOUPAPE Tous les joints de couvercle de soupape pour l'étanchéité du moteur.
17950-17999	KIT DE CÁRTER Todas las juntas y retenes del cárter de aceite, o la junta del cárter de aceite de goma moldeada de una pieza, necesarias para sellar un motor.	OIL PAN SETS SERIES All oil pan gaskets & seals, or one-piece molded rubber oil pan gasket, required to seal one engine.	GUARNIZIONE COPPA DELL'OLIO Tutte le guarnizioni e le tenute della coppa dell'olio, o la guarnizione in gomma stampata in un unico pezzo, necessarie per sigillare un motore.	KIT DE CARTER D'HUILE Tous les joints de carter d'huile, ou un joint de carter d'huile en caoutchouc moulé d'une seule pièce, nécessaires à l'étanchéité d'un moteur.

120 / 205L (120 HP)

REF	CULATA	CYLINDER HEAD	TESTATA	CULASSE
	REC17000 JUNTA CULATA	CYLINDER HEAD	GUARNIZIONE TESTATA	JOINT DE CULASSE
	REC17200 KIT JUNTAS SUPERIOR	GASKET HEAD SET	KIT PARTE ALTA	KIT DE JOINTS SUPÉRIEURS
REF	INFERIOR	CONVERSION	PARTE BASSA	PARTIE BASSE
	REC17100 KIT JUNTAS INFERIOR (2361802+) Retén 2 piezas, 4 piezas junta cárter.	CONVERSION GASKET SET (2361802+) 2 piece rear main bearing seal & 4 piece oil pan gasket	KIT PARTE BASSA (2361802+) Paraolio in 2 px, 4 pz guarnizione coppa dell'olio.	KIT DE JOINTS INFÉRIEURS (2361802+) Joint d'huile 2 pièces, joint de carter 4 pièces.
REF	COLECTOR ADMISIÓN-ESCAPE	MANIFOLD INTAKE & EXHAUST	COLLETTORE ASPIRAZIONE-SCARICO	COLLECTEUR ADMISION ET ÉCHAPPEMENT
	REC27-52546 Junta admisión-escape (1666601 - 6229717)	Intake-Exhaust gasket (1666601 - 6229717)	Guarnizione aspirazione - scarico (1666601 - 6229717)	Joint admision et échappement (1666601 - 6229717)

	REC27-96429	Junta admisión-escape (6229718+)	Intake-Exhaust gasket (6229718+)	Guarnizione aspirazione - scarico (6229718+)	Joint admision et échappement (6229718+)
REF	CARTER		OIL PAN	COPPA DELL'OLIO	CARTER
	REC17950	KIT JUNTAS CARTER Retén trasero dos piezas, 4 piezas junta cárter.	GASKET OIL PAN SET Two piece rear main bearing seal & 4 piece oil pan gasket	KIT GUARNIZIONE Paraolio posteriore in 2, guarnizione coppa in 4 pz.	KIT DE JOINTS CARTER Joint arrière en deux parties, Joint de carter 4 pièces.
REF	TAPA VÁLVULAS		VALVE COVER	COPERCHIO VALVOLE	COUVERCLE
	REC17900	Junta	Gasket	Guarnizione	Joint
REF	TAPA EMPUJADORES		PUSH ROD COVER	COPERCHIO ASTE PUNTERIE	COUVERCLE
	REC17903	Junta	Gasket	Guarnizione	Joint







140 / 3.0L, 140 / 3.0LX (115,130, 135, 140 HP)

REF	CULATA		CYLINDER HEAD	TESTATA	CULASSE
	REC17000	JUNTA CULATA	CYLINDER HEAD	GUARNIZIONE TESTATA	JOINT DE CULASSE
	REC17200	KIT JUNTAS SUPERIOR	GASKET HEAD SET	KIT PARTE ALTA	KIT DE JOINTS SUPÉRIEURS
REF	INFERIOR		CONVERSION	PARTE BASSA	PARTIE BASSE
	REC17102	KIT JUNTAS Retén 1 pieza. Junta cárter 1 pieza.	GASKET SET 1 piece rear main bearing seal & 4 piece oil pan gasket	KIT Paraolio in 1 pz. Guarnizione coppa dell'olio in 1 pz.	KIT JOINTS INFÉRIEURS Joint spi 1 pièce. Joint de carter 1 pièce.
	REC17100	KIT JUNTAS INFERIOR (2361802+) Retén 2 piezas, 4 piezas junta cárter.	CONVERSION GASKET SET (2361802+) 2 piece rear main bearing seal & 4 piece oil pan gasket	KIT PARTE BASSA (2361802+) Paraolio in 2 pz, 4 pz guarnizione coppa dell'olio.	KIT PARTIE INFÉRIEURE (2361802+) Joint d'huile 2 pcs, 4 pièces de joint de carter.
REF	COLECTOR ADMISIÓN-ESCAPE		MANIFOLD INTAKE & EXHAUST	COLLECTORE ASPIRAZIONE-SCARICO	COLLECTEUR ADMISION ET ÉCHAPPEMENT
	REC27-96429	Junta (6229718+) excepto 3.0 LX	Gasket (6229718+) excl. 3.0 LX	Guarnizione (6229718+) eccetto 3.0 LX	Joint (6229718+) sauf 3.0 LX seulement
	REC27-815528	Junta (6229718+) sólo 3.0 LX	Gasket (6229718+) only 3.0 LX	Guarnizione (6229718+) solo 3.0 LX	Joint (6229718+) 3.0 LX uniquement
	REC27-53354	Junta (-9229717)	Gasket (-9229717)	Guarnizione (-9229717)	Joint (-9229717)
REF	CARTER		OIL PAN	COPPA DELL'OLIO	CARTER
	REC17950	KIT JUNTAS Retén trasero dos piezas, 4 piezas junta cárter.	GASKET SET Two piece rear main bearing seal & 4 piece oil pan gasket	KIT GUARNIZIONE Paraolio posteriore in 2, guarnizione coppa in 4 pz.	KIT DE JOINTS Joint arrière en deux parties, Joint de carter 4 pièces.
REF	TAPA VÁLVULAS		VALVE COVER	COPERCHIO VALVOLE	COUVERCLE SOUPAPES
	REC17900	Junta	Gasket	Guarnizione	Joint
REF	TAPA EMPUJADORES		PUSH ROD COVER	COPERCHIO ASTE PUNTERIE	COUVERCLE
	REC17903	Junta	Gasket	Guarnizione	Joint

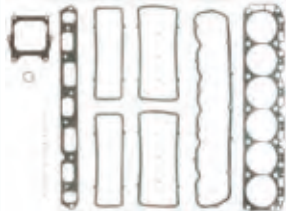

165, 170, 180, 190, 470, 485, 488









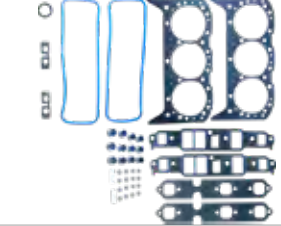
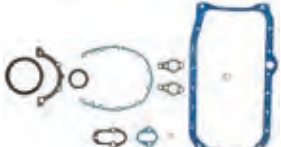

REF	CULATA		CYLINDER HEAD	TESTATA	CULASSE
	FEL17069	JUNTA CULATA	CYLINDER HEAD	GUARNIZIONE TESTATA	JOINT DE CULASSE

160 HP, 165 HP (2770032 - 6916778)

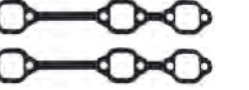
REF	CULATA	CYLINDER HEAD	TESTATA	CULASSE	
	FEL17019	JUNTA CULATA	CYLINDER HEAD	GUARNIZIONE TESTATA	JOINT DE CULASSE
	FEL17219	KIT JUNTAS SUPERIOR SIN juntas colector escape-admisión	GASKET HEAD SET WITHOUT Intake & Exhaust manifold gasket not included	KIT PARTE ALTA SENZA guarnizioni collettore scarico- aspirazione	KIT JOINTS SUPÉRIEUR SANS joints de collecteur d'échappement - admission
REF	INFERIOR	CONVERSION	PARTE BASSA	PARTIE BASSE	
	FEL17119	KIT JUNTAS INFERIOR Solo cárter 24 tornillos	CONVERSION GASKET SET 24 bolt oil pan only	KIT PARTE BASSA Solo coppa con 24 viti.	KIT JOINTS INFÉRIEUR Seulement carter avec 24 vis
REF	COLECTOR ADMISIÓN-ESCAPE	MANIFOLD INTAKE & EXHAUST	COLLETTORE ASPIRAZIONE-SCARICO	COLLECTEUR ADMISION ET ÉCHAPPEMENT	
	FEL17302	Junta	Gasket	Guarnizione	Joint
REF	CARTER	OIL PAN	COPPA DELL'OLIO	CARTER	
	FEL17975	KIT JUNTAS Solo cárter 24 tornillos	GASKET SET 24 bolt oil pan only	KIT GUARNIZIONE Solo coppa con 24 viti.	KIT DE JOINTS Seulement carter avec 24 vis
REF	TAPA VÁLVULAS	VALVE COVER	COPERCHIO VALVOLE	COUVERCLE SOUPAPES	
	FEL17925	Junta	Gasket	Guarnizione	Joint
REF	TAPA EMPUJADORES	PUSH ROD COVER	COPERCHIO ASTE PUNTERIE	COUVERCLE	
	FEL17926	Junta	Gasket	Guarnizione	Joint

4.3L: 155, 175 HP • 4.3LX: 175, 180, 205 HP • 175 & 185 HP 2 BBL. • 205 HP 4 BBL

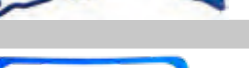
REF	CULATA	CYLINDER HEAD	TESTATA	CULASSE	
	REC17010	Se necesitan dos	2 required	Necessarie 2	Deux sont nécessaires
	REC17210	Motor sin eje equilibrado. Incluye juntas tapa válvulas y retenes.	Engine without balance shaft. Valve cover gaskets and premium valve stem seals included.	Motore senza asse bilanciato. Include guarnizione coperchio punterie e paraoli valvole.	Moteur sans arbre d'équilibrage. Comprend les joints de cache culbuteur et les joints d'étanchéité.
	REC17211	Motor con eje equilibrado. Incluye juntas tapa válu- las y retenes.	Engine with balance shaft. Valve cover gaskets and premium valve stem seals included.	Motore con asse bilanciato. Include guarnizione coperchio punterie e paraoli valvole.	Moteur avec arbre d'équilibrage. Comprend les joints de cache culbuteur et les joints d'étanchéité.
REF	INFERIOR	CONVERSION	PARTE BASSA	PARTIE BASSE	
	REC17115	KIT JUNTAS INFERIOR Motor sin eje equilibrado con retén de una pieza y 1 pieza junta cárter. Incluye Junta de cárter.	CONVERSION GASKET SET Engine without balance shaft with one-piece rear main bearing seal & 1 piece oil pan gasket; oil pan gasket incl.	KIT PARTE BASSA Motore senza asse bilanciato. Paraolio post in 1 pz e guarnizione coppa in 1 pz. Include la guarnizione del carter.	KIT DE JOINTS INFÉRIEURS Moteur équilibré sans arbre, avec joint d'huile en une pièce et joint de carter en une pièce, y compris le joint de carter.

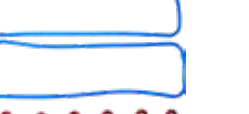

	REC17110	KIT JUNTAS INFERIOR Motor sin eje equilibrado con retén de 2 piezas y 4 piezas junta cárter. Incluye Junta de cárter.	CONVERSION GASKET SET Engine without balance shaft with 2 piece rear main bearing seal & 4 pieces oil pan gasket; oil pan gasket incl.	KIT PARTE BASSA Motore senza asse bilanciato. Paraolio post in 2 pz e guarnizione coppa in 4 pz. Include la guarnizione del carter.	KIT DE JOINTS INFÉRIEURS Moteur équilibré sans arbre avec joint d'huile 2 pièces et joint de carter 4 pièces. Comprend un joint de carter.
	REC17116	KIT JUNTAS INFERIOR Motor con eje equilibrado con retén de 1 pieza y 1 pieza junta cárter. Incluye Junta de cárter.	CONVERSION GASKET SET Engine without balance shaft with one-piece rear main bearing seal & 1 piece oil pan gasket; oil pan gasket incl.	KIT PARTE BASSA Motore con asse bilanciato. Paraolio post in 1 pz e guarnizione coppa in 1 pz. Include la guarnizione del carter.	KIT DE JOINTS INFÉRIEURS Moteur avec arbre équilibré avec joint d'arbre 1 pièce et joint de carter 1 pièce. Comprend un joint de carter.
	REF	COLECTOR ADMISION-ESCAPE	MANIFOLD INTAKE & EXHAUST	COLLETTORE ASPIRAZIONE-SCARICO	COLLECTEUR ADMISSION ET ECHAPPEMENT
	REC17310	Junta Admisión-Escape	Intake-Exhaust Gasket	Guarnizione aspirazione	Joint d'admission et d'échappement
	REC824326002	Junta Admisión Vortec (2 unid.)	Intake Gasket Vortec (2 units)	guarnizione aspirazione Vortec (2 unità)	Joint d'admission Vortec (2 pièces)
	REC27-99757	Kit juntas colector - escape	Exhaust gasket set	Kit guarnizione scarico	Kit joints collecteur d'échappement
	REF	CARTER	OIL PAN	COPPA DELL'OLIO	CARTER
	REC17970	KIT JUNTAS CARTER 4 piezas junta cárter. (Retén 2 piezas)	GASKET OIL PAN SET 4 piece oil pan gasket (2 piece Seal)	KIT GUARNIZIONE Guarnizione coppa in 4 pz. (paraolio 2 pz)	KIT JOINTS 4 pièces carter.
	REC17971	1 junta carter (Retén 1 pieza)	1 piece oil pan gasket (1 piece seal)	Guarnizione coppa in 1 pz (paraolio 1 pz)	1 joint carter (Joint d'huile 1 pièce)
	REC27-142471	1 Junta Carter de goma (-2008)	1 rubber oil pan gasket (-2008)	Guarnizione 1 pz (-2008)	1 Joint de carter en caoutchouc (-2008)
	REC21124852	1 Junta Carter de goma (2008+)	1 rubber oil pan gasket (2008+)	Guarnizione 1 pz (2008+)	1 Joint de carter en caoutchouc (2008+)
	REF	TAPA VÁLVULAS	VALVE COVER	COPERCHIO VALVOLE	COUVERCLE SOUPAPES
	REC17920	Motor sin eje equilibrado.	Engine without balance shaft	Motore senza asse equilibrato.	Moteur sans arbre équilibré.
	REC17921	Motor con eje equilibrado.	Engine with balance shaft	Motore con asse equilibrato.	Moteur avec arbre équilibré







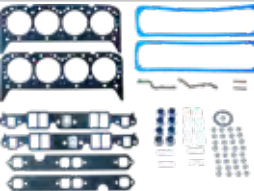
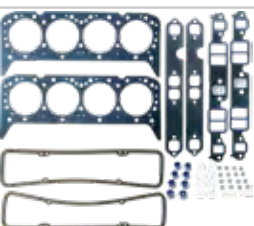

5.0L: 215 HP, 225 HP , 888 (198 HP) FORD

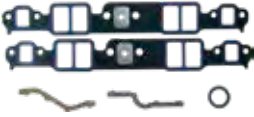
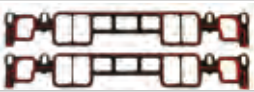
REF	CULATA	CYLINDER HEAD	TESTATA	CULASSE	
	FEL17060	JUNTA CULATA Se necesitan dos	CYLINDER HEAD 2 required	GUARNIZIONE TESTATA Necessarie 2	JOINT DE CULASSE Deux sont nécessaires
	FEL17260	KIT JUNTAS SUPERIOR Incluye retenes válvulas.	GASKET HEAD SET Premium valve stem seals incl.	KIT PARTE ALTA include paraoli valvole	KIT DE JOINTS SUPÉRIEURS Comprend les joints de valve.



REF	INFERIOR	CONVERSION	PARTE BASSA	PARTIE BASSE
	FEL17160	KIT JUNTAS	CONVERSION GASKET SET	KIT GUARNIZIONE KIT JOINTS
REF	COLECTOR ADMISION-ESCAPE	MANIFOLD INTAKE & EXHAUST	COLLETORE ASPIRAZIONE-SCARICO	COLLECTEUR ADMISION ET ECHAPPEMENT
	FEL17360	KIT JUNTAS ADMISION-ESCAPE	INTAKE-EXHAUST GASKET SET	KIT GUARNIZIONI ASPIRAZIONE - SCARICO KIT JOINTS ADMISION - ECHAPPEMENT
	REC3852455	JUNTA COLECTOR -ESCAPE	OIL PAN - EXHAUST GASKET	GUARNIZIONE COPPA OLIO - SCARICO JOINT COLLECTEUR D'ECHAPPEMENT
REF	CARTER	OIL PAN	COPPA DELL'OLIO	CARTER
	FEL17995	Retén 2 piezas	2 pieces seal	Paraolio 2 pz Joint spi 2 pièces
REF	TAPA VÁLVULAS	VALVE COVER	COPERCHIO VALVOLE	COUVERCLE SOUPAPES
	FEL17945	Con tapa de válvulas de acero	With iron valve cover	Con coperchio valvole in acciaio Cache culbuteur en acier









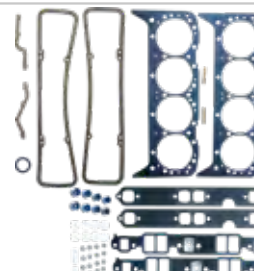

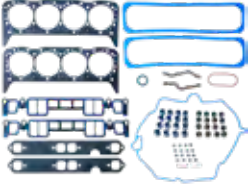
5.0L: 180, 190, 200, 228, 230 HP
5.0LX: 205, 230 HP; 198/888 (198HP)

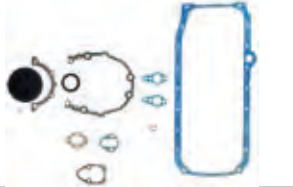
REF	CULATA	CYLINDER HEAD	TESTATA	CULASSE
	REC17020	Se necesitan dos	2 required	Ne servono 2 2 sont nécessaires
	REC17224	Tornillo centro tapa válvulas. Incluye retenes válvulas.	With center bolt desing valve covers. Premium valve stem seals included.	Viti coperchio punterie al centro. Include paraoli valvole. Cache culbuteur avec les vis centrales. Comprend les joints de queue de soupapes.
	REC17220	Tornillo en el lateral tapa válvulas. Incluye retenes válvulas.	Rim bolt desing valve covers. Premium valve stem seals included.	Viti coperchio punterie nel perimetro. Include paraoli valvole. Cache culbuteur avec les vis laterales. Comprend les joints de queue de soupapes.
REF	INFERIOR	CONVERSION	PARTE BASSA	PARTIE BASSE
	REC17125	Retén de 1 pieza y junta cárter de 1 pieza Incluye junta de cárter.	One-piece rear main bearing seal & 1 piece oil pan gasket. Oil pan gasket included.	Paraolio in 1 peze e guarnizione coppa in 1 peze. Include paraolio coppa. Joint spi 1 pièce. Joint de carter 1 pièce. Comprend le Joint spi.
	REC17120	Retén de 2 piezas y junta cárter de 4 piezas	Two-piece rear main bearing seal & 4 pieces oil pan gasket.	Paraolio in 2 peze e guarnizione coppa in 4 pezi. Joint spi 2 pièces et joint de carter 4 pièces.

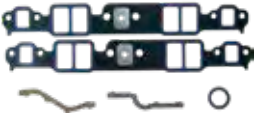
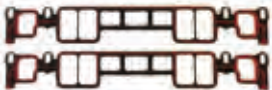
	REF	COLECTOR ADMISIÓN-ESCAPE	MANIFOLD INTAKE & EXHAUST	COLLETTORE ASPIRAZIONE-SCARICO	COLLECTEUR ADMISION ET ÉCHAPPEMENT
	REC17320	Kit junta admisión-escape.	Intake-exhaust gasket set.	Kit guarnizioni aspirazione - scarico.	Kit joints d'admission.
	REC27-807473A1	JUNTA ADMISIÓN Vortec (2 unid.) Junta de plástico.	INTAKE GASKET Vortec (2 units). Gasket in plastic.	GUARNIZIONE ASPIRAZIONE Vortec necessita 2 pz. Guarnizione in plastica	JOINT ADMISION Vortec (2 unités). Joint en plastique.
	REC27-33395	Kit juntas colector escape	Oil pan - exhaust gasket set.	Kit guarnizione Coppa olio - scarico.	Kit joints collecteur d'échappement.
	REF	CARTER	OIL PAN	COPPA DELL'OLIO	CARTER
	REC17982	Junta cárter 1 pieza. Junta de cárter incluida.	1 piece oil pan gasket. Molded rubber oil pan gasket included.	Guarnizione in 1 pz. Guarnizione coppa included.	Joint de carter 1 pièce.
	FEL17983	Junta 1 pieza. Para motores con retén trasero de 2 piezas.	1 piece molded rubber gasket for engines with Two-piece rear main bearing sea.	Guarnizione in 1 pz, paraolio posteriore in 2 px.	Joint de carter 1 pièce pour moteurs avec Joint spi arrière 2 pièces.
	REC17980	Varilla aceite de BABOR con retén trasero de 2 piezas y junta cárter de 4 piezas.	PORT dipstick with 2-piece rear main bearing seal & 4-piece oil pan gasket.	Asticella olio a SINISTRO con paraolio posteriore in 2 pz. e guarnizione coppa da 4 pz.	Jauge d'huile à BABORD avec Joint spi arrière en 2 pièces et joint de carter en 4 pièces.
	REC17981	Varilla aceite de ESTRIBOR con retén trasero de 2 piezas y junta cárter de 4 piezas.	STARBOARD dipstick with 2-piece rear main bearing seal & 4-piece oil pan gasket	Asticella olio DESTRO con paraolio posteriore in 2 pz e guarnizione coppa da 4 pz.	Jauge d'huile à TRIBORD avec Joint spi arrière en 2 pièces et joint de carter en 4 pièces.
	REF	RETÉN TRASERO CIGÜEÑAL	CRANKSHAFT REAR SEAL	PARAOLIO POSTERIORE ALBERO MOTORE	JOINT ARRIÈRE DE VILEBREQUIN
	FEL17725	Retén partido. Contrarrotación. De goma; dos piezas.	Split seal Rev. rotation, rubber; two-piece	Controrotazione in 2 pz. in gomma.	Joint contre-rotation en 2 pièces, en caoutchouc.
	REF	TAPA VÁLVULAS	VALVE COVER	COPERCHIO VALVOLE	COUVERCLE SOUPAPE
	REC17931	Tornillo centro tapa válvulas con juntas.	Molded rubber gaskets incl.	Coperchio punterie con viti centrali.	Fixation par vis centrale
	REC17930	Tornillo en el canto.	Rim bolt desing	Coperchio punterie con viti nel perimetro.	Fixation par 4 vis laterales.





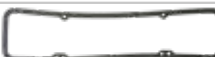

**BLACK SCORPION (315 HP) 5.7L: 230, 235, 260 HP • 5.7L BLUE WATER INBOARD 250, 260 HP
5.7L BRAVO, 240, 250, 270 HP • 5.7L COMP SKI, 250, 260 HP, 255 HP, 300, 300 MR/TR
350 MAGNUM, 350 MAGNUM TOURNAMENT SKI (240, 250, 265, 270 HP)**

	REF	CULATA	CYLINDER HEAD	TESTATA	CULASSE
	REC17030	Se necesitan dos	2 required	Ne servono 2	2 sont nécessaires
	REC17214	Tornillo centro tapa válvulas. Incluye retenes válvulas.	With center bolt desing valve covers. Premium valve stem seals included.	Viti coperchio punterie al centro. Include paraoli valvole.	Cache culbuteur avec les vis centrales. Comprend les joints de queue de soupapes.
	REC17230	Tornillo en el lateral tapa válvulas. Incluye retenes válvulas.	Rim bolt desing valve covers. Premium valve stem seals included.	Viti coperchio punterie nel perimetro. Include paraoli valvole.	Cache culbuteur avec les vis laterales. Comprend les joints de queue de soupapes.

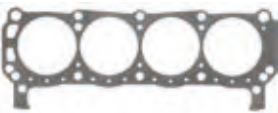
	REC17232	Juntas del colector admisión de plástico. Retenes válvulas incluidos.	Gasket head set with plastic intake manifold gaskets. Premium valve stem. Seals incl.	Kit con guarnizione aspirazione in plastica. Paraoli valvole inclusi.	Kit joint collecteur aspiration de plastique. Comprend les joints de queue de soupapes.
REF	INFERIOR	CONVERSION	PARTE BASSA	PARTIE BASSE	
	REC17125	Retén de 1 pieza y junta cárter de 1 pieza Incluye junta de cárter.	One-piece rear main bearing seal & 1 piece oil pan gasket. Oil pan gasket included.	Paraolio in 1 peze e guarnizione coppa in 1 peze. Include paraolio coppa.	Joint spi 1 pièce. Joint de carter 1 pièce. Comprend le Joint spi.
	FEL17124	Con tapa de distribución de plástico, retén de 1 pieza y junta cárter de 1 pieza.	Engine with plastic timing cover, with 1 piece bearing seal & 1 piece oil pan gasket.	Cárter distribuzione in plastica, paraolio in 1 pz e guarnizione coppa olio in 1 pz.	Pour carter de distribution en plastique, joint arrière monobloc et joint de carter monobloc. Joint de carter inclus.
	REC17120	Retén de 2 piezas y junta cárter de 4 piezas	Two-piece rear main bearing seal & 4 pieces oil pan gasket.	Paraolio in 2 peze e guarnizione coppa in 4 pezi.	Joint spi 2 pièces et joint de carter 4 pièces.
REF	COLECTOR ADMISION-ESCAPE	MANIFOLD INTAKE & EXHAUST	COLLETORE ASPIRAZIONE-SCARICO	COLLECTEUR ADMISION ET ECHAPPEMENT	
	REC17320	Kit Juntas Admisión-Escape	Intake-Exhaust Gasket Set	Kit guarnizioni aspirazione - SCARICO	Kit joints d'admission
	REC27-807473A1	JUNTA ADMISION Vortec (2 unid.) Junta de plástico.	INTAKE GASKET Vortec (2 units) Gasket in plastic.	GUARNIZIONE Vortec necessita 2 pz guarnizione in plastica	JOINT ADMISION Vortec (2 pièces). Joint en plastique.
	FEL17420	Kit juntas colector -escape	Oil pan - Exhaust gasket set	Kit guarnizione coppa olio - SCARICO	Kit joints collecteur-d'échappement
REF	CARTER	OIL PAN	COPPA DELL'OLIO	CARTER	
	REC17982	Junta cárter 1 pieza. Incluye Junta de cárter.	1 piece oil pan gasket. Molded rubber oil pan gasket included.	Guarnizione in 1 pz. Include guarnizione coppa.	Joint de carter 1 pièce. Comprend joint de carter.
	FEL17983	1 pieza junta para motores con retén trasero de 2 piezas.	1 piece molded rubber gasket for engines with 2-piece rear main bearing seal.	Guarnizione in 1 pz, paraolio posteriore in 2 px.	Joint 1 pièce pour moteurs avec Joint spi arrière 2 pièces.
	REC17980	Varilla aceite de BABOR con retén trasero de 2 piezas y junta cárter de 4 piezas.	PORT dipstick with 2-piece rear main bearing seal & 4-piece oil pan gasket.	Asticella olio a SINISTRO con paraolio posteriore in 2 pz. e guarnizione coppa da 4 pz.	Jauge d'huile à BABORD avec Joint spi arrière en 2 pièces et joint de carter en 4 pièces.
	REC17981	Varilla aceite de ESTRIBOR con retén trasero de 2 piezas y junta cárter de 4 piezas.	STARBOARD dipstick with 2-piece rear main bearing seal & 4-piece oil pan gasket	Asticella olio DESTRO con paraolio posteriore in 2 pz e guarnizione coppa da 4 pz.	Jauge d'huile à TRIBORD avec Joint spi arrière en 2 pièces et joint de carter en 4 pièces.
REF	RETÉN TRASERO CIGÜEÑAL	Crankshaft rear seal	PARAOLIO POSTERIORE ALBERO MOTORE	JOINT D'HUILE DE VILEBREQUIN ARRIERE	
	FEL17725	Retén partido. Contrarrotación. De goma; dos piezas.	Split seal Rev. rotation, rubber; two-piece	Controrotazione in 2 pz. in gomma.	Joint en caoutchouc en 2 pièces pour moteur en contre rotation.

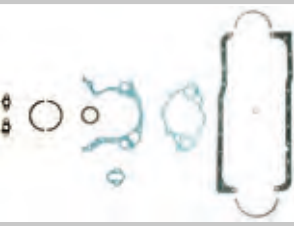
	REF	TAPA VÁLVULAS	VALVE COVER	COPERCHIO VALVOLE	COUVERCLE DE SOUPE
	REC17931	Tornillo centro tapa válvulas con juntas.	Molded rubber gaskets incl.	Coperchio punterie con viti centrali.	Cache culbuteur avec vis centrales.
	REC17930	Tornillo en el canto.	Rim bolt desing	Coperchio punterie con viti nel perimetro.	Cache culbuteur avec vis latérales.
	REF	RETÉN DISTRIBUCIÓN	OIL SEAL TIMING COVER	PARAOLIO DISTRIBUZIONE	JOINT D'HUILE DE DISTRIBUTION
	REC3853341	Reten contrarotación Motor sin tapa distribución de plástico.	Reverse rotation oil seal Engines w/o plastic timing cover.	Paraolio controrotante. Motore senza carter distribuzione in plastica.	Joint de contre-rotation du moteur sans cache-souape en plastique.

**5.8L 233 (3258728 - 4175499) (233 HP)
255 (3258728 - 4175499) (255 HP)
FORD**









	REF	CULATA	CYLINDER HEAD	TESTATA	CULASSE
	FEL17060	Se necesitan dos.	2 required.	Ne servono 2.	2 sont nécessaires.
	FEL17260	Con retenes valvula.	Premium valve stem.	Include paraolio valvole.	Comprend les joints de queue de soupapes.
	REF	INFERIOR	CONVERSION	PARTE BASSA	PARTIE BASSE
	FEL17165	Retén 2 piezas, 4 piezas junta cárter.	2 piece rear main bearing seal Et 4 piece oil pan gasket,	Paraolio in 2 pz, 4 pz guarnizione coppa dell'olio.	KIT JOINTS
	REF	COLECTOR ADMISIÓN-ESCAPE	MANIFOLD INTAKE & EXHAUST	COLLETORE ASPIRAZIONE-SCARICO	COLLECTEUR ADMISSION ET ÉCHAPPEMENT
	FEL17360	Kit Juntas Admisión.	Intake gasket set.	Kit guarnizioni aspirazione	Kit joints admission
	REC3852455	Junta escape.	Exhaust gasket.	Guarnizione scarico.	Joints de collecteur d'échappement.
	REF	CARTER	OIL PAN	COPPA DELL'OLIO	CARTER
	FEL17996	Cárter 4 piezas.	4 piece oil pan gasket.	4 pz coppa.	Joint de carter en 4 pièces.
	REF	TAPA VÁLVULAS	VALVE COVER	COPERCHIO VALVOLE	COUVERCLE
	FEL17945	Con tapa de válvulas de acero	With iron valve cover	Con coperchio valvole in acciaio	Cache culbuteur en acier

7.4L 454 V8: 420 HP GEN IV & V • 425 (385, 400, 425 HP GEN IV & V) • 525 SC (500 HP GEN V)
 7.4L BLUE WATER INBOARD (-D715493) (310, 340 HP GEN IV)
 7.4L BLUE WATER INBOARD (D715494+) (310 HP GEN V)
 7.4L BRAVO (-D603117) (300, 330 HP GEN. IV)
 7.4L BRAVO I (D603118+) (300, 330 HP GEN V)
 7.4L BRAVO II (D603118+) (300, 330 HP GEN V)
 7.4L BRAVO III (D603118+) (3350 HP GEN V)
 7.4L EFI (F215800+) (310 HP GEN V), 330, 340, 350, 370TRS, • 400 TRS GEN IV, 450 HP GENE V
 454 MAGNUM ALPHA (A631894 - B785148) (330 HP GEN IV)
 454 MAGNUM BRAVO (B721206 - D805068) (350, 365 HP GENE IV)
 454 MAGNUM BRAVO (D805069+) (350 HP GENE V)

	REF	CULATA	CYLINDER HEAD	TESTATA	CULASSE
	REC17040	Gen IV exc. H.O. Se necesitan dos	Gen IV exc. H.O. 2 required	Gen IV escluso H.O. Necessarie 2	Gen IV exc. H.O. Deux sont nécessaires.
	FEL17049	JUNTA CULATA Gene IV sólo H.O. super medida. Se necesitan 2.	CYLINDER HEAD Gene IV H.O. only super bore 2 required	GUARNIZIONE TESTATA Gene IV solo H.O. maggiorata. Necessarie 2	JOINT DE CULASSE Gene IV seulement H.O. super taille. 2 sont nécessaires.
	REC17046	JUNTA CULATA Gene IV sólo H.O. Se necesitan 2.	CYLINDER HEAD Gene IV H.O. only 2 required	GUARNIZIONE TESTATA Gene IV solo H.O. Necessarie 2	JOINT DE CULASSE Gene IV seulement H.O. 2 sont nécessaires.
	REC17042	Gen IV & V. Se necesitan 2.	Gen IV & V. 2 required	Gen IV e V. Necessarie 2	Gen IV et V. Deux sont nécessaires.
	REC17240	Gen IV exc. H.O. con admisión ovalada. Se incluye retenes de válvula.	Gen IV exc. H.O. with oval intake ports. Premium valve stem seals included.	Gen IV escluso H.O. con aspirazione ovale. Inclusi paraoli valvole.	Gen IV exc. H.O. avec admission ovale. Joints de queue de soupape inclus.
	REC17241	KIT JUNTAS SUPERIOR Gene IV exc. H.O. con admisión rectangular. Se incluye retenes de válvula	GASKET HEAD SET Gen IV exc. H.O. w/ rectangular intake ports; premium valve stem seals incl.	KIT PARTE ALTA Gene IV escluso H.O. con aspirazione rettangolare. Inclusi paraoli valvole.	KIT DE JOINTS SUPÉRIEURS Gene IV exc. H.O. avec admission rectangulaire. Joints de soupape inclus
	REC17246	KIT JUNTAS SUPERIOR Gene V sólo H.O. con admisión rectangular. Se incluye retenes de válvula	GASKET HEAD SET Gen IV only H.O. w/ rectangular intake ports; premium valve stem seals incl.	KIT PARTE ALTA Gene IV solo H.O. con aspirazione rettangolare. Inclusi paraoli valvole.	KIT DE JOINTS SUPÉRIEURS Gene IV uniquement H.O. avec admission rectangulaire. Joints de soupape inclus
	REC17242	KIT JUNTAS SUPERIOR Gene V & VI H.O. con admisión ovalada. Se incluye retenes de válvula.	GASKET HEAD SET Gen V & VI or H.O. w/oval intake ports; premium valve stem seals incl.	KIT PARTE ALTA Gene V e VI H.O. con aspirazione ovale. Include paraoli valvole.	KIT DE JOINTS SUPÉRIEURS Gene V et VI et H.O. avec admission ovale. Joints de soupape inclus.
	REC17243	Gen V & VI solo H.O. con admisión rectangular, juntas tapa válvulas y retenes incluidos.	Gen V & VI, H.O. only, with rectangular intake ports valve cover gaskets and premium valve stem seals incl.	Gen V e VI solo H.O. con aspirazione rettangolare, guarnizione coperchio punterie e paraoli inclusi.	Gen V et VI H.O. uniquement avec admission rectangulaire, joints de cache culbuteur et joints de queue de soupape inclus.

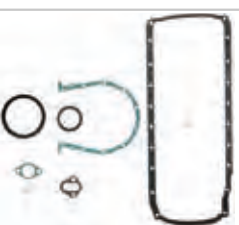
	FEL17205	Gen VI sólo EFI Juntas de tapa válvulas y retenes incluidos.	Gen VI, EFI only, valve cover gaskets and premium valve stem seals incl.	Gen VI, solo EFI guarnizione rettangolare, guarnizione coperchio punterie e paraoli inclusi.	Gen V EFI uniquement. Joints de cache culbuteur et joints de queue de soupape inclus.
	REF	INFERIOR	CONVERSION	PARTE BASSA	PARTIE INFÉRIEUR
	REC17140	Gene IV con retén trasero de dos piezas y junta cárter de 4 piezas.	Gene IV w/two piece rear main bearing seal & four piece oil pan gasket.	Gene IV con paraolio posteriore in 2 pz. e guarnizione coppa dell'olio in 4 pz.	Gene IV avec joint arrière en deux parties et joint de carter en 4 parties.
	FEL17145	Gene V con retén trasero de una pieza y junta cárter incluida.	Gene V w/one piece rear main bearing seal & one piece oil pan gasket. oil pan gasket. incl.	Gene V con paraolio posteriore in 1 pz. e guarnizione coppa dell'olio in 1 pz.	Gene V avec joint arrière monobloc et joint de carter monobloc. Joint de carter inclus.
	REC17146	Gene VI con retén trasero de una pieza y junta cárter incluida.	Gene VI w/one piece rear main bearing seal & one piece oil pan gasket. oil pan gasket. incl.	Gene VI con paraolio posteriore in 1 pz. e guarnizione coppa dell'olio in gomma in 1 pz.	Gene VI avec joint à lèvres arrière en une seule pièce et joint de carter en une seule pièce. Joint de carter inclus.
	REF	COLECTOR ADMISION-ESCAPE	MANIFOLD INTAKE & EXHAUST	COLLETTORE ASPIRAZIONE-SCARICO	COLLECTEUR ADMISION ET ECHAPPEMENT
	REC17341	KIT JUNTA ADMISION Gene IV, V y VI sólo H.O. con admisión rectangular. Gene IV, excl. H.O. con admisión rectangular.	INTAKE GASKET SET Gene IV, V & VI, H.O. only w/rectangular intake ports Gene IV excl. H.O. w/rect. intake ports	KIT GUARNIZIONI ASPIRAZIONE Gene IV, V e VI sólo H.O. con aspirazione rettangolare Gene IV escluso H.O. con aspirazione rettangolare	KIT DE JOINTS D'ADMISSION Gènes IV, V et VI uniquement H.O. avec admission rectangulaire. Gene IV, excl. H.O. avec admission rectangulaire.
	REC17340	KIT JUNTA ADMISION Gene IV, excl. H.O. con admisión oval. Gene V y VI exc. EFI y H.O. con admisión ovalada.	INTAKE GASKET SET Gene IV excl. H.O. w/oval intake ports Gene V & VI, excl. EFI & H.O. w/oval intake ports	KIT GUARNIZIONI ASPIRAZIONE Gene IV escluso H.O. con aspirazione ovale. Gene V e VI escluso EFI e H.O. con aspirazione ovale	KIT DE JOINTS D'ADMISSION Gene IV, excl. H.O. avec prise ovale. Gène V et VI exc. EFI et H.O. avec admission ovale.
	REC17342	KIT JUNTA ADMISION Gene V y VI sólo EFI	INTAKE GASKET SET Gene V & VI, EFI only	KIT GUARNIZIONI ASPIRAZIONE Gene V e VI, solo EFI	KIT DE JOINTS D'ADMISSION Gene V et VI EFI uniquement
	REC27-46820	KIT JUNTA ESCAPE Gene IV, V y VI.	EXHAUST GASKET SET Gene IV, V & VI	KIT GUARNIZIONI SCARICO Gene IV, V e VI	KIT DE JOINTS D'ECHAPPEMENT Gene IV, V et VI.
	REF	RETÉN TRASERO CIGÜEÑAL	Crankshaft rear seal	PARAOLIO POSTERIORE ALBERO MOTORE	JOINT D'HUILE DE VILEBREQUIN ARRIÈRE
	REC26-14756	Gene IV Retén Contrarrotación dos piezas	Gene IV Reverse rotation oil seal Two- pieces	Gene IV Controrotante in 2 pz.	Gene IV Joint d'huile contre-rotatif en deux parties
	REF	TAPA VÁLVULAS	VALVE COVER	COPERCHIO VALVOLE	COUVERCLE SOUPAPES
	REC17935	Gen IV	Gen IV	Gen IV	Gen IV
	REC17937	Gen V & VI	Gen V & VI	Gen V e VI	Gen V et VI

8.2L 502 V8 HP465 (465 HP GEN. V) HP 600 SC (550HP GEN. V)
 8.5L (-D857199) (400 HP GEN. IV)
 8.2L (D857200 - F819619) (400 HP GEN.V) 500 (470 HP GEN V)
 502 MAGNUM BRAVO (-D824588) (390HP GEN IV)
 502 MAGNUM BRAVO (D824589+) (390 & 415 HP GEN. V)

REF	CULATA	CYLINDER HEAD	TESTATA	CULASSE
 FEL17049	Gen IV sólo H.O. super medida. Se necesitan 2.	Gen IV H.O. only super bore 2 required	Gen IV solo H.O. maggiorata. Necessarie 2	Gen IV seulement H.O. super taille. 2 sont nécessaires.
 REC17048	Gen IV, V & VI. Se necesitan 2.	Gen IV, V & VI. 2 required	Gen IV, V e VI. Necessita 2	Gen IV, V et VI. 2 sont nécessaires.
 REC17248	Gen IV & Gene V exc. EFI. Se incluye retenes de válvula y juntas tapa válvulas.	Gen IV & Gen V exc. EFI Premium valve stem seals & valve cover gaskets included.	Gen IV e Gene V escluso EFI. Include paraolio e guarnizione del coperchio valvola	Gen IV et Gen V exc. EFI. Les joints de cache culbuteur et de queue de soupape sont inclus.
 REC17207	Gen V & VI solo EFI. Se incluye retenes de válvula y juntas tapa válvulas.	Gen V & VI EFI only. Premium valve stem seals & valve cover gaskets included.	Gen V e VI solo EFI. Include paraolio e guarnizione del coperchio valvola	Gen V & VI EFI uniquement. Les joints de cache culbuteur et de queue de soupape sont inclus.
REF	INFERIOR	CONVERSION	PARTE BASSA	PARTIE BASSE
 REC17140	Gene IV con retén trasero de dos piezas y junta cárter de 4 piezas.	Gene IV w/two piece rear main bearing seal & four piece oil pan gasket.	Gene IV con paraolio posteriore in 2 pz. e guarnizione coppa dell'olio in 4 pz.	Gene IV avec joint arrière en deux parties et joint de carter en 4 parties.
 FEL17145	Gene V con retén trasero de una pieza y junta cárter de 1 pieza. Junta cárter incluida.	Gene V w/one piece rear main bearing seal & one piece oil pan gasket. oil pan gasket. incl.	Gene V con paraolio posteriore in 1 pz. e guarnizione coppa dell'olio in 1 pz.	Gene IV avec joint arrière en deux parties et joint de carter en 4 parties.
 REC17146	Gene VI con retén trasero de una pieza y junta cárter de 1 pieza. Junta cárter incluida.	Gene VI w/one piece rear main bearing seal & one piece oil pan gasket. oil pan gasket. incl.	Gene VI con paraolio posteriore in 1 pz. e guarnizione coppa dell'olio in gomma in 1 pz.	Gene VI avec joint arrière monobloc et joint de carter monobloc. Joint de carter inclus.
REF	COLECTOR ADMISIÓN-ESCAPE	MANIFOLD INTAKE & EXHAUST	COLLETORE ASPIRAZIONE-SCARICO	COLLECTEUR ADMISION ET ÉCHAPPEMENT
 REC17341	Gen IV, V y VI sólo H.O. con admisión rectangular. Gene IV, excl. H.O. con admisión rectangular.	Gen IV, V & VI, H.O. only with rectangular intake ports. Gen IV excl. H.O. with rect. intake ports.	Gen IV, V e VI solo H.O. con aspirazione rettangolare. Gen IV escluso H.O. con aspirazione rettangolare.	Gen IV, V et VI uniquement H.O.: avec admission rectangulaire. Gen IV, exc. H.O. avec admission rectangulaire.
 REC17340	JUNTA ADMISIÓN Gen V & VI sólo EFI.	INTAKE GASKET Gen V & VI only EFI.	GUARNIZIONE ASPIRAZIONE Gen V & VI solo EFI.	Joint d'admission Gen V et VI uniquement EFI.
REF	RETÉN TRASERO CIGÜEÑAL	CRANKSHAFT REAR SEAL	PARAOLIO POSTERIORE ALBERO MOTORE	JOINT D'HUILE DE VILEBREQUIN ARRIERE
 REC26-14756	Gen IV. Retén Contrarrotación dos pieza.	Gen IV. Reverse rotation oil seal Two- pieces	Gen IV. Controrotante in 2 pz.	Gen IV. Joint spi contre-rotatif en 2 parties.

	REF	TAPA VÁLVULAS	VALVE COVER	COPERCHIO VALVOLE	COUVERCLE SOUPPES
	REC17935	Gen IV	Gen IV	Gen IV	Gen IV
	REC17937	Gen V & VI	Gen V & VI	Gen V e VI	Gen V et VI

JUNTAS DISTRIBUCIÓN TIMING GASKETS GUARNIZIONE DISTRIBUZIONE JOINTS DISTRIBUTION

JUNTA TAPA DISTRIBUCION TIMING CHAIN COVERS GASKETS GAURNIZIONE CARTER JOINT COUVERCLE DISTRIBUTION

REF	OEM	
REC27-49953	27-49953	4 & 6 Cyl. GM120, 140, 160/165, 2.5L, 3.0LX/L (1963+)

REF	OEM	
REC27-56108	27-56108	FORD V8 302, 351 (1970-77)

REF	OEM	
REC27-54529	27-54529	454 CID 427, 454, 482, 502 (-1992)

REF	OEM	
REC27-850456	27-85046	454, 502 / 7.4 & 8.2L GEN V & VI (1996+) Race Sterndrive 500, 520, 525, 540, 565, 575, 600, 662, 700

REF	OEM	
REC27-68714A6	27-68714	224 CID 165, 170, 180, 190, 470, 485 & 488

REF	OEM	
REC27-14250	27-14250	V6 & V8 (-1997)

RETENES SEALS TENUTE JOINTS D'HUILE

GUÍA TÓRICAS O-RING GUIDE GUIDA O-RING GUIDE JOINT SPI

REF	OEM	REF	OEM	REF	OEM	REF	OEM
REC25-20081	25-20081	REC25-30613	25-30613	REC25-38099	25-38099	REC25-62705	25-62705
REC25-16524	25-20415	REC553126	25-31305	REC25-38101	25-38101	REC25-62706	25-62707
REC25-16524	25-16524	REC3852866	25-31986	REC25-38933	25-38933	REC25-823683	25-823683
REC308627	25-20826	REC304174	25-32509	REC326849	25-39695	REC333572	25-64068
REC25-80863	25-20863	REC25-32546	25-32546	REC25-457101	25-457101	REC331188	25-65936
REC25-21836	25-21836	REC25-33145	25-33145	REC326649	25-45711	REC313175	25-67202
REC25-25439	25-25439	REC25-33465	25-33465	REC310414	25-47254	REC25-67202	25-67202
REC333572	25-26543	REC302537	25-33466	REC25-48171	25-48171	REC25-70937	25-70937
REC302588	25-26722	REC0307239	25-33504	REC302035	25-48452	REC3852865	25-805331
REC303347	25-26802	REC305123	25-33756	REC25-33465	25-54029	REC25-89497	25-89497
REC3852928	25-26855	REC25-35029	25-35029	REC25-55801	25-55801	REC25-90011	25-90011
REC309731	25-29439	REC310584	25-35276	REC909140	25-58390	REC25-97387	25-97387
REC25-30224	25-30224Q	REC321921	25-35480	REC25-62700	25-62700		
REC25-30529	25-30529	REC301967	25-36318	REC3852045	25-62704		

GUÍA RETENES ACEITE

OIL SEALS GUIDE

GUIDA PARAOLIO

GUIDE JOINTS D'HUILE

REF	OEM	Ø EJE SHAFT Ø ASSE Ø ARBRE (*)	Ø EXTERIOR OUTER Ø Ø ESTERNO Ø EXTERIEUR (*)	REF	OEM	Ø EJE SHAFT Ø ASSE Ø ARBRE (*)	Ø EXTERIOR OUTER Ø Ø ESTERNO Ø EXTERIEUR (*)	REF	OEM	Ø EJE SHAFT Ø ASSE Ø ARBRE (*)	Ø EXTERIOR OUTER Ø Ø ESTERNO Ø EXTERIEUR (*)
REC26-12224	26-12224	1.1875	1.6875	REC26-455771	26-45577 1	0.3125	0.4375	REC26-8164641	26-8164641	0.3750	0.7500
REC26-12709	26-12709	0.5000	0.6875	REC26-45587	26-45587	0.3750	0.6250	REC26-821092	26-821092	1.5000	2.2500
REC26-76868	26-14077	1.1875	1.6875	REC26-55682	25-55682	1.0000	1.2500	REC26-823894	26-823894	2.2500	3.0000
REC26-14240	26-14240	3.8125	4.5000	REC26-56397	26-56397	0.7500	1.1250	REC26-24590	26-892361	0.3750	0.7500
REC26-16977	26-16977	0.8750	1.2500	REC26-56788	26-56788	0.8750	1.2500	REC26-89238	26-89238	0.8750	1.5000
REC908855	26-20070	0.6250	1.0000	REC26-62818	26-62818	1.6250	2.2500	REC26-90562	26-90562	0.7500	1.2500
REC310599	26-26226	1.0000	1.5000	REC26-66302	26-66302	1.2500	1.8750	REC26-94038	26-94038	1.0000	1.5000
REC26-30913	26-30913	0.5000	1.1875	REC26-69188	26-69188	0.8750	1.2500	REC26-897153	26-96063	0.4375	0.8750
REC26-24590	26-31249	0.3750	0.5625	REC26-69189	26-69189	0.8750	1.3125	REC26-965031	26-965031	0.8750	1.3750
REC26-32511	26-32511	1.2500	2.0000	REC26-70081	26-70081	1.1875	1.7500	REC26-43993	26-43993	1640	2132
REC26-32911	26-32911	1.1250	1.2500	REC26-72785	26-72785	0.7500	1.8750	REC26-67388	26-67388	1800	3100
REC26-33467	26-33467	0.6250	1.1250	REC26-76868	26-76868	1.1875	1.6875	REC26-33467	26-33467	625	1125
REC26-419533	26-41953	1.1875	1.8750	REC26-79831	26-79831	0.7500	1.1250	REC26-16977	26-16977	875	1250
REC26-43035	26-43035	1.0625	1.4375	REC26-861694	26-805080	2.5000	3.1875	REC26-24590	26-24590	400	566
REC26-43036	26-43036	1.0312	1.4687	REC26-807006	26-807006	1.6875	2.2500	REC26-55682	26-55682	1000	1253

VÁLVULA ADMISIÓN

INTAKE VALVE

VALVOLA ASPIRAZIONE

SOUPAPE ADMISSION

REF	OEM	Ø EJE SHAFT Ø ASSE Ø ARBRE (*)	Ø EXTERIOR OUTER Ø Ø ESTERNO Ø EXTERIEUR (*)
REC70817B	26-97664 26-976641 26-8M0050563	4.3L, 5.0L, Et 5.7L old Et MPI (1983-97)	



RETENES VÁLVULAS

VALVE STEM SEAL

PARAOLIO VALVOLE

JOINT DE QUEUE DE SOUPAPE

REF	OEM	Ø EJE SHAFT Ø ASSE Ø ARBRE (*)	Ø EXTERIOR OUTER Ø Ø ESTERNO Ø EXTERIEUR (*)
REC26-34217	26-34217	4 en línea y 6 cil, GM antiguos early vecchio ancienes V6/V8	



REF	OEM	Ø EJE SHAFT Ø ASSE Ø ARBRE (*)	Ø EXTERIOR OUTER Ø Ø ESTERNO Ø EXTERIEUR (*)
REC26-75988	26-75988	330 (4623115+) 340 (5889914+) 454 Mag (A631894+)	



RETÉN VÁLVULA ESCAPE

VALVE STEM SEAL

GUARNIZIONE DELLO STELO DELLA VALVOLA

JOINT DE TIGE DE SOUPAPE

new

REF	OEM	Ø EJE SHAFT Ø ASSE Ø ARBRE (*)	Ø EXTERIOR OUTER Ø Ø ESTERNO Ø EXTERIEUR (*)
REC26-8M0150312	26-8M0150312 26-804507	V6 Et V8 small Vortec Et MPI	



RETÉN ADMISIÓN Y ESCAPE

INTAKE & EXHAUST VALVE

PARAOLIO ASPIRAZIONE E ESCARICO

JOINT D'HUILE ADMISSION ET ECHAPPEMENT

REF	OEM	Ø EJE SHAFT Ø ASSE Ø ARBRE (*)	Ø EXTERIOR OUTER Ø Ø ESTERNO Ø EXTERIEUR (*)
REC26-75624	26-75624 26-75413	165, 170, 180, 190 4 CIL. (224 cid) (6916779+) 888 (2bbl) Ford 302 V8 (1971-77) 3.7 L, LX (1980-89) 470 (1976-81) 488 (1983-84)	



RETENES CIGÜENAL

CRANKSHAFT SEAL

PARAOLIO ALBERO MOTORE

JOINTS D'HUILE VILEBREQUIN

REF	OEM	Ø EJE SHAFT Ø ASSE Ø ARBRE (*)	Ø EXTERIOR OUTER Ø Ø ESTERNO Ø EXTERIEUR (*)
FELBS40013	26-814622	5.0, 5.7L (-1986)	



REF	OEM	Ø EJE SHAFT Ø ASSE Ø ARBRE (*)	Ø EXTERIOR OUTER Ø Ø ESTERNO Ø EXTERIEUR (*)
REC3853341	36-97335		
REC26-8219471	26-8219471		
REC26-67388	26-67388		
REC26-8219471	26-8219471		



REF	OEM	Ø EJE SHAFT Ø ASSE Ø ARBRE (*)	Ø EXTERIOR OUTER Ø Ø ESTERNO Ø EXTERIEUR (*)
REC26-14240	26-14240	4.3, 5.0, 5.7L Standard Rot.	



REF	OEM	Ø EJE SHAFT Ø ASSE Ø ARBRE (*)	Ø EXTERIOR OUTER Ø Ø ESTERNO Ø EXTERIEUR (*)
REC26-14240	26-14240		
REC26-811554	26-811554		
REC26-90925	26-90925		
RM26-879194364			
FEL17725			



REF	OEM	Ø EJE SHAFT Ø ASSE Ø ARBRE (*)	Ø EXTERIOR OUTER Ø Ø ESTERNO Ø EXTERIEUR (*)
REC26-14756	26-14756	7.4, 8.2L (1991+)	



REF	OEM	Ø EJE SHAFT Ø ASSE Ø ARBRE (*)	Ø EXTERIOR OUTER Ø Ø ESTERNO Ø EXTERIEUR (*)
FEL17740	26-75980		



GUÍA RETENES CIGÜEÑAL		CRANKSHAFT SEAL GUIDE		GUIDA PARAOLIO ALBERO MOTORE		GUIDE JOINTS D'HUILE DU VILEBREQUIN	
MOD.	SERIE SERIAL SERIE	TRASERO REAR POSTERIORE DERRIERE	DELANTERO FRONT ANTERIORE DAVANT	MOD.	SERIE SERIAL SERIE	TRASERO REAR POSTERIORE DERRIERE	DELANTERO FRONT ANTERIORE DAVANT
120/2.5L	1666601		REC3853341	5.0L, 5.7L, 4.3L, 3.0L (Rot. STD 1 p.)		REC26-14240	REC3853341
120/2.5L	2786857	FELBS40013	REC3853341	340 (7.4L)	4623115	FEL17740	REC26-8219471
140/3.0L & LX	2508261		REC3853341	370 TRS	5889914		REC26-8219471
140/3.0L & LX	6229718	FELBS40013	REC3853341	400 TRS	4179554		REC26-8219471
150, 160, 165, 200 (I/L-6)	1666495		REC3853341	420	A398941+		REC26-8219471
150, 160, 165, 200 (I/L-6)	2770032	FELBS40013	REC3853341	440 TRS	4179554		REC26-8219471
175, 185, 205, 262 4.3L (V-6)	6330183	FELBS40013	REC3853341	454 MAGNUM	A631894+		REC26-8219471
200, 228, 225, 230, 250,				460 TRS	4179554		REC26-8219471
255, 260, 270, 280, 300, 320	2453769	FELBS40013	REC3853341	7.4, 8.2L, 454, 502 (Rot. STD 1 p.)		REC26-811554	REC26-8219471
5.0L/5.7L/898 (V-8)				7.4 BRAVO	B771113+		REC26-8219471
224I/L4		REC26-90925	REC26-67388				

JUNTAS MOTOR ENGINE GASKETS GUARNIZIONE MOTORE JOINTS DE MOTEUR

470, 485, 488, 165, 170, 180 & 190 HP
4 CYL EN LINEA | IN LINE | IN LINEA | EN LIGNE

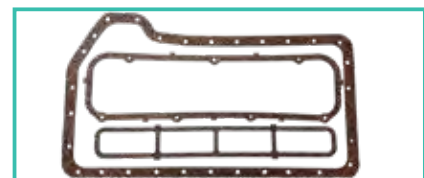
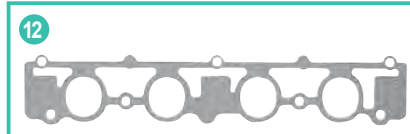
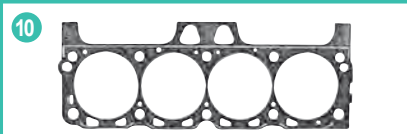
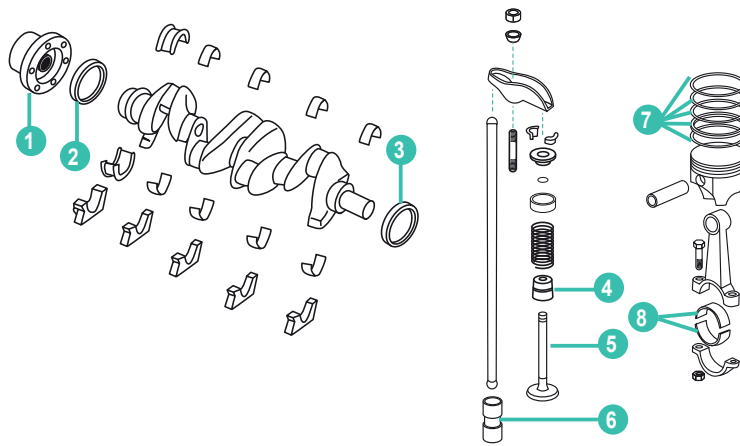

REF	OEM
REC27-72479A5	27-72479A5

	REF	OEM	MOD.				UN.	
1	REC97432A2	97432A2	470 (1983-89), 165, 170, 3.7L	ACOPLAMIENTO MOTOR	ENGINE COUPLER ASSEMBLY	GIUNTO PARASTRAPPI	COUPLING	1
	REC69354A2	69354A2	470 & 485 (1976-82)					
2	REC26-90925	26-90925		RETÉN TRASERO	REAR MAIN SEAL	PARAOLIO POSTERIORE	JOINT SPI VILEBREQUIN	1
3	REC26-67388	26-67388		RETÉN DELANTERO	FRONT CRANKSHAFT SEAL	TENUTA ALBERO MOTORE	JOINT D'HUILE	1
4	REC26-75624	26-75624		RETÉN VÁLVULA	VALVE STEM SEAL	PARAOLIO VALVOLA	JOINT QUEUE DE SOUPEPE	8
	FEDV-3929	75416	470	VÁLVULA ADMISIÓN	INTAKE VALVE	VALVOLA ASPIRAZIONE	SOUPEPE ADMISSION	4
5	RM44181A1	44181A1	485					
	FEDV-1984	44182A1	470	VÁLVULA ESCAPE	EXHAUST VALVE	VALVOLA SCARICO	SOUPEPE ÉCHAPPEMENT	4
	RM44182A1	44182A1	485					
6	REC3853847	56153		LIFTER	TAPPET	LIFTER	POUSSOIR HYDRAULIQUE	8
7	REC39-74381A1	39-74381A1		AROS PISTON STD.	PISTON RINGS STD.	FASCE PISTONE STD.	KIT SEGMENTS STD	4
8	REC23-853853002	23-853853002		COJINETES BIELA STD.	ROD BEARING STD.	BRONZINE DI BIELLA STD.	COUSSINET DE BIELLE STD	4
	REC23-853855001	23-853855001		COJINETES BIELA 010	ROD BEARING 010	BRONZINE DI BIELLA 0.10	COUSSINET DE BIELLE 0.10	4
9	REC27-73666	27-73666	224 CID (3.7 L)	JUNTA TAPA VÁLVULAS	VALVE COVER GASKET	GUARNIZIONE COPERCHIO PUNTERIE	JOINTS COUVERCLE SOUPEPE	
10	REC27-13709	27-13709	224 CID (3.7 L) CID Model 470	JUNTA CULATA	HEAD GASKET	GUARNIZIONE TESTATA	JOINT CULASSE	
11	REC27-68715	27-68715	460 CID	JUNTA COLECTOR ESCAPE	EXHAUST MANIFOLD GASKET	GUAR. COLLETTORE SCARICO	JOINT COLLECTEUR ÉCHAP.	
12	REC27-70905	27-70905	3.7 L	JUNTS COLECTOR ADMISION	INTALKE MANIFOLD GASKET	GUAR. COLLETTORE ASPIRAZIONE	JOINT COLLECTEUR ADMI.	

SISTEMA DE ESCAPE Y ADMISIÓN EXHAUST & INTAKE SYSTEM

SISTEMA DI SCARICO E ASPIRAZIONE SYSTEME D'ÉCHAPPEMENT ET D'ADMISSION

120HP GM 153
4CYL

COLECTOR ESCAPE

EXHAUST MANIFOLD

COLLETTORE SCARICO

COLLECTEUR
D'ÉCHAPPEMENT

REF	OEM
BAMC-1-63122	63122A14 63122A10 63122A13



JUNTA COLECTOR

MANIFOLD GASKET

GUARNIZIONE
COLLETTORE

JOINT COLLECTEUR

REF	OEM
REC27-52546	27-52546
REC27-35898T	27-35898T



REC27-52546

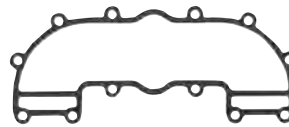

REC27-35898T

TAPA COLECTOR

END CAP

COPERCHIO COLLETTORE

COVERCLE COLLECTEUR

REF	OEM
BA1-47638	47638A1
HGE4870	73813A1



BA1-47638



HGE4870

JUNTA TAPA COLECTOR

END CAP GASKET

GUARNIZIONE
COPERCHIO COLLETTORE

JOINT COVERCLE
COLLECTEUR

REF	OEM
REC27-39917	27-39917
BAMC47-27-39923	27-39923

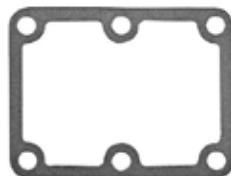

REC27-39917

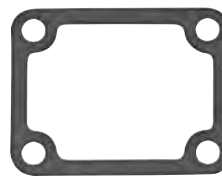

BAMC47-27-39923

CODO ESCAPE

ELBOW MANIFOLD

GOMITO DI SCARICO

COUDE D'ÉCHAPPEMENT

REF	OEM
BAMC-20-55538	55538A2



JUNTA CODO ESCAPE

ELBOW MANIFOLD
GASKET

GUARNIZIONE GOMITO DI
SCARICO

JOINT COUDE
D'ÉCHAPPEMENT

REF	OEM
REC27-39915	27-39915

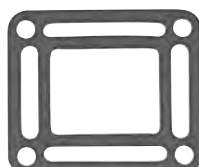

DESPIECES COLECTORES Y CODOS MANIFOLDS & ELBOWS PARTS PARTI COLLETTORI E GOMITI PIÈCES COLLECTEURS ET COUDES

140HP GM181
4 CYL (1968-82)

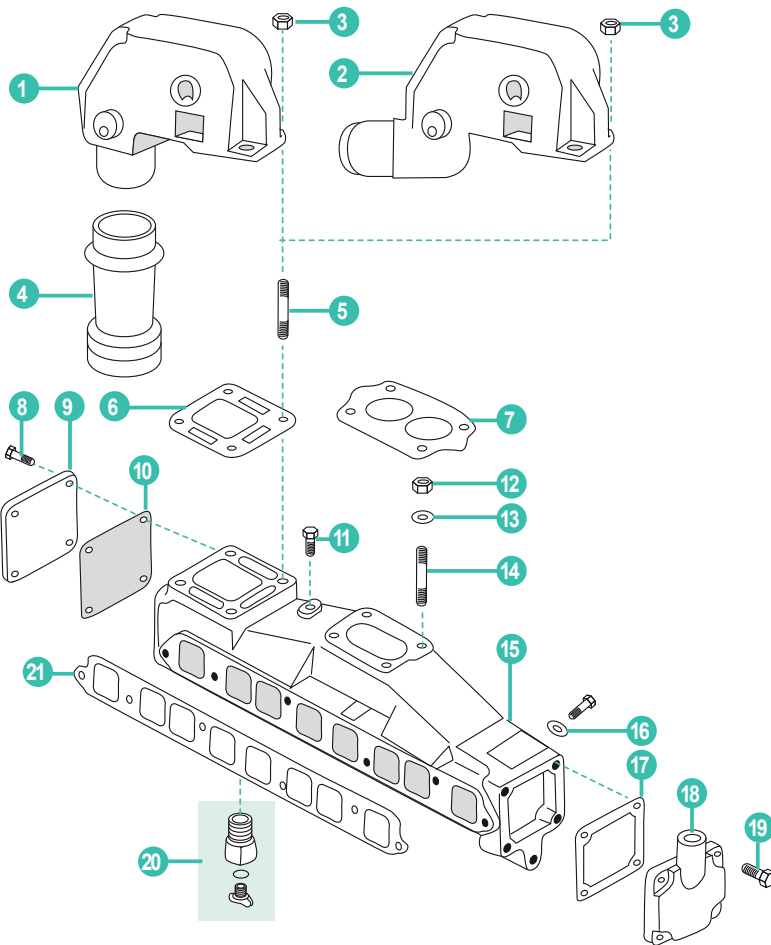

REF OEM
REC18-8549



REF OEM
HOT26371-MK

	REF	OEM				UN.	
1	HOT20971	76351A04	CODO ESCAPE 3"	EXHAUST ELBOW ASSY 3"	GOMITO DI SCARICO	COUDE D'ÉCHAPPEMENT 3"	1
2	HOT20978 REC76771A2	76771A2	CODO ESCAPE 3"	EXHAUST ELBOW ASSY 3"	GOMITO DI SCARICO 3"	COUDE D'ÉCHAPPEMENT 3"	1
3	REC46335	46335	TUERCA	FLANGE SERRATED NUT	DADO	ÉCROU	4
4	REC53114A1 CEF500524	53114A1	FUELLE ESCAPE	EXHAUST ELBOW BELOW	MANICOTTO SCARICO COLLETTORE	SOUFFLET D'ÉCHAPPEMENT	6
5	REC16-49545	16-49545	ESPARRAGO CODO	STUD	PRIGIONIERO	GOUJON DE COLLECTEUR	4
6	REC27-99777Q02	27-99777Q02	JUNTA CODO	GASKET EXHAUST MANIFOLD TO ELBOW	GUARNIZIONE INTERMEDIA	JOINT COUDE	1
7	REC27-64692	27-64692	JUNTA BASE CARB.	GASKET CARBURETOR BASE	GUARNIZIONE BASE CARB.	JOINT BASSE DU CARBURATEUR	1
8	RM10-25299	10-824941	TORNILLO TAPA	SCREW END CAP	VITE COPERCHIO	VIS COUVERCLE	4
9	HGE4870	73813A1	TAPA COLECTOR	END CAP EXHAUST MANIFOLD	COPERCHIO	COUVERCLE	1
10	REC27-807218	27-807218	JUNTA TAPA	GASKET END CAP	GUARNIZIONE COPERCHIO	JOINT COUVERCLE	1
11	REC22-36382	22-36382	TAPON	PLUG	TAPPO	BOUCHON	1
12	REC11-862902	11-862902	TUERCA	LOCKNUT CARBURETOR	DADO	ÉCROU	4
13	REC12-20084	12-20084	ARANDELA	WASHER CARBURETOR	RONDELLA	RONDELLE	4
14	REC16-70236	16-70236	ESPARRAGO CARBURADOR	STUD CARBURETOR	PRIGIONIERO CARBURATORE	GOUJON CARBURATEUR	4
15	REC96705A1	96705A1	COLECTOR ESCAPE	EXHAUST MANIFOLD ASSEMBLY	COLLETTORE	COLLECTEUR	1
16	REC13-35048	21-20553	ARANDELLA	WASHER	RONDELLA	RONDELLE	6
17	REC27-480431	27-480431	JUNTA TAPA	GASKET END CAP	GUARNIZIONE COPERCHIO	JOINT COUVERCLE	1
18	REC60252A2	60252A2	TAPA COLECTOR	END CAP EXHAUST MANIFOLD	COPERCHIO COLLETTORE	COUVERCLE COLLECTEUR	1
19	REC10-35386	10-35386	TORNILLO TAPA	SCREW END CAP	VITE COPERCHIO	VIS COUVERCLE	4
20	REC13980	22-806608A1	TORNILLO DRENAJE	STRAIGHT FITTING	VITE DI DRENAGGIO	VIS DE VIDANGE	1
21	REC27-53354	27-53354	JUNTA COLECTOR	GASKET-EXHAUST MANIFOLD	GUARNIZIONE COLLETTORE	JOINT COLLECTEUR	1

2.5L GM 153 4 CYL
3.0L 4 CYL (1983-89)

MODELO ANTIGUO
OLD STYLE OPTION
MODELLO VECCHIO
MODEL ANCIEN

MODELO MODERNO
NEW STYLE OPTION
MODELLO MODERNO
MODEL MODERN

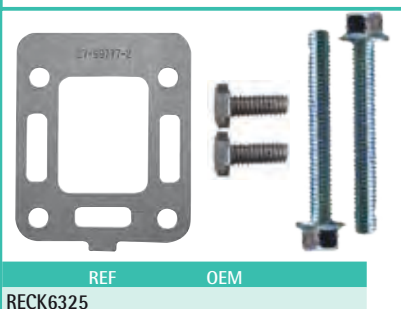
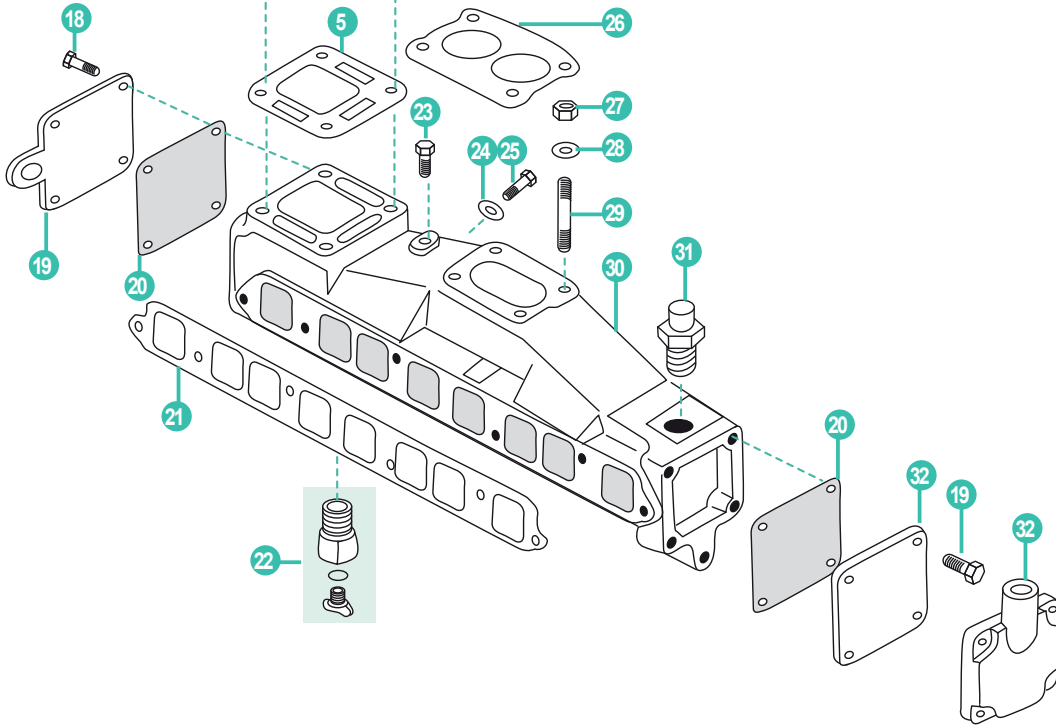
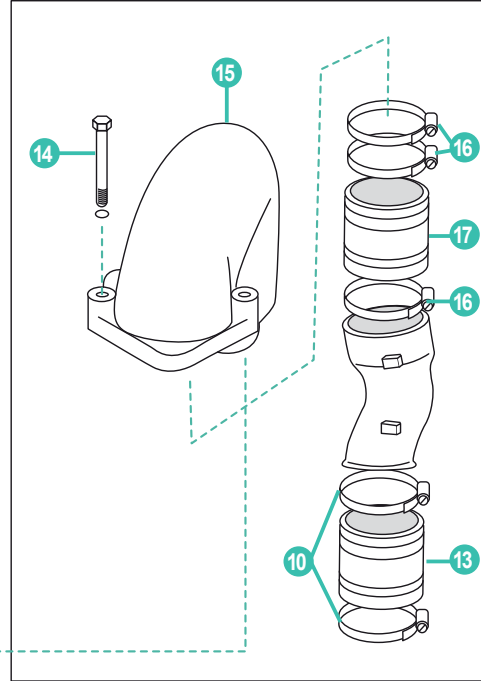
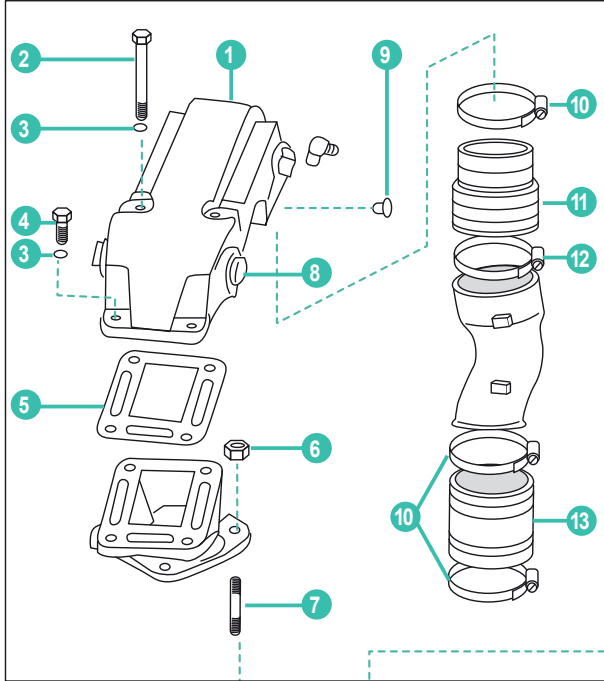

	REF	OEM					UN.
1	REC76325A2	76325A2	CODO ESCAPE	EXHAUST ELBOW ASSEMBLY	GOMITO SCARICO	COUDE D'ÉCHAPPEMENT	1
2	REC10-72094	10-72094	TORNILLO CODO ESCAPE	SCREW EXHAUST ELBOW	VITE GOMITO SCARICO	VIS COUDE D'ÉCHAPPEMENT	2
3	REC13-35048	13-35048	ARANDELA	LOCKWASHER	RONDELLA	RONDELLE	4
4	REC10-34354	10-34354	TORNILLO CODO ESCAPE	SCREW EXHAUST ELBOW	VITE GOMITO SCARICO	VIS	2
5	REC27-99777Q02	27-99777Q02	JUNTA COLLECTOR ESCAPE A CODO	GASKET EXHAUST MANIFOLD TO ELBOW OR ADAPTOR	GUARNIZIONE COLLETTORE SCARICO E RISER	JOINT COUDE D'ÉCHAPPEMENT	2
6	REC46335	46335	TUERCA	FLANGE SERRATED NUT	DADO	ÉCROU	4
7	REC16-56826	16-56826	ESPARRAGO	STUD	PRIGIONIERO	GOUJON	4
8	REC22-41622	22-41622	TAPON	PLUG EXHAUST ELBOW	TAPPO	BOUCHON	4
9	REC22-328022	22-328022	TAPÓN	PLUG	TAPPO	BOUCHON	1
10	GS38320	54-815504256	ABRAZADERA	HOSE CLAMP	FASCETTA	COLLIER INOX	3
11	REC70981A3	70981A3	FUELLE ESCAPE	EXHAUST BELLOW (USE WITH 2-PIECE EXHAUST ELBOW)	MANICOTTO SCARICO	DURITE D'ÉCHAPPEMENT	1
12	GS38322	54-815504372	ABRAZADERA	HOSE CLAMP	FASCETTA	COLLIER	1
13	REC32-90949T	32-90949T	FUELLE	EXHAUST TUBE	CUFFIA	SOUFFLET	1
14	REC10-668631	10-668631	TORNILLO	SCREW	VITE	VIS	2
15	SED3092610	12076A2	CODO ESCAPE INOX	STAINLESS STEEL EXHAUST ELBOW	GOMITO SCARICO INOX	COUDE D'ÉCHAPPEMENT INOX	1
	MAR076		CODO ESCAPE	EXHAUST ELBOW ASSEMBLY	GOMITO SCARICO	COUDE D'ÉCHAPPEMENT	1
16	GS38320	54-815504372	ABRAZADERA 4"	CLAMP BELLOW 4"	FASCETTA 4"	COLLIER 4"	2
17	REC32-44348001	32-44348001	FUELLE ESCAPE 4"	EXHAUST BELLOW EXHAUST ELBOW 4"	CUFFIA SCARICO 4"	SOUFFLET D'ÉCHAPPEMENT 4"	1
18	RM10-25299	10-824941	TORNILLO COLECTOR ESCAPE	SCREW END CAP TO EXHAUST MANIFOLD	VITE COLLETTORE SCARICO	VIS COLLECTEUR D'ÉCHAPPEMENT	8
19	REC805629A1	805629A1	TAPA COLECTOR ESCAPE	END CAP EXHAUST MANIFOLD	COPERCHIO COLLETTORE SCARICO	COUVERCLE COLLECTEUR D'ÉCHAPPEMENT	1
20	REC27-807218	27-807218	JUNTA	GASKET END CAP	GUARNIZIONE COPERCHIO COLLETTORE	JOINT COUVERCLE COLLECTEUR	2
21	REC27-96429	27-96429	JUNTA CODO ESCAPE	GASKET EXHAUST MANIFOLD	GUARNIZIONE GOMITO SCARICO	JOINT COUDE D'ÉCHAPPEMENT	1
22	REC13980	22-806608A1	RACORD COLECTOR	STRAIGHT DRAIN KIT	RACCORDO COLLETTORE	RACCORD COLLECTEUR	1
23	REC22-36382	22-36382	TAPÓN	PLUG	TAPPO	BOUCHON	1
24	REC13-35048	21-20553	ARANDELA	WASHER	FASCETTA	RONDELLE	2
25	REC10-53728	10-53728	TORNILLO	SCREW (NEW DESIGN)	VITE	VIS	3
26	REC27-8079821	27-8079821	JUNTA BASE CARBURADOR (MERCAB)	GASKET CARBURETOR BASE (MERCAB)	GUARNIZIONE BASE CARBURATORE (MERCAB)	JOINT DE BASE CARBURATEUR (MERCAB)	1
	REC27-64692	27-64692	JUNTA BASE CARBURADOR (ROCHESTER)	GASKET CARBURETOR BASE (ROCHESTER)	GUARNIZIONE BASE CARBURATORE (ROCHESTER)	JOINT DE BASE CARBURATEUR (ROCHESTER)	1
27	REC11-862902	11-862902	TUERCA	LOCK NUT CARBURETOR	CHIUSURA	ÉCROU	4
28	REC12-20084	12-20084	ARANDELA	WASHER CARBURETOR	RONDELLA	RONDELLE	4
29	REC16-70236	16-70236	ESPARRAGO	STUD CARBURETOR	PRIGIONIERO	GOUJON	4
30	BAMC-1-95862	95862A5	COLECTOR ESCAPE (ROCHESTER)	EXHAUST MANIFOLD (ROCHESTER)	COLLETTORE SCARICO (ROCHESTER)	COLLECTEUR D'ÉCHAPPEMENT (ROCHESTER)	1
	HOT20956	860235A04	COLECTOR ESCAPE (MERCAB)	EXHAUST MANIFOLD (MERCAB)	COLLETTORE SCARICO (MERCAB)	COLLECTEUR D'ÉCHAPPEMENT (MERCAB)	1
31	REC22-866725	22-866725	ENTRONQUE 3/4-14x1 (LATÓN)	STRAIGHT FITTING 3/4-14 x 1 (BRASS)	RACCORDO 3/4-14x1 (OTTONE)	RACCORD COLLECTEUR (LAITON)	1
32	HGE4870	73813A1	TAPA COLECTOR ESCAPE	END CAP - EXHAUST MANIFOLD	COPERCHIO COLLETTORE SCARICO	COUVERCLE COLLECEUR D'ÉCHAPPEMENT	1
	REC60252A2	60252A2	TAPA COLECTOR PIPA	MANIFOLD CAP PIPE	COPERCHIO COLLETTORE SCARICO	PLAQUE A/TUYAU	1

Para determinar el tipo de carburador (Rochester / Mercab) ver medida de junta:
 To determine the type of carburetor (Rochester / Mercab) see joint measurement:
 Per determinare il tipo di carburatore (Rochester / Mercab) vedi misurazione di guarnizione:
 Pour déterminer le carburateur (Rochester / Mercab) voir la mesure de joint:



3.0L & 3.0LX GM 181
4 CYL (1990+)



REF
HOT20975-MK

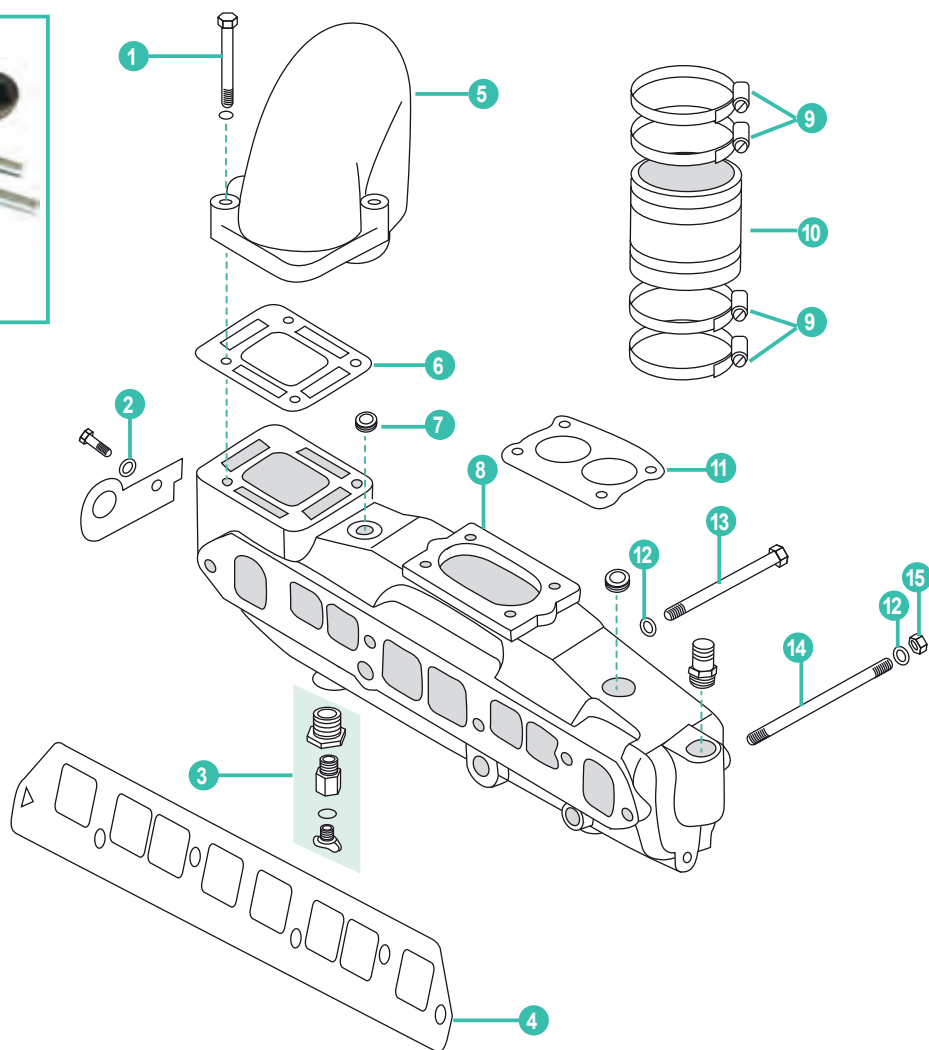

	REF	OEM					UN.
1	REC10-668631	10-668631	TORNILLO	SCREW	VITE	VIS	2
2	REC12-20084	12-20084	ARANDELA	WASHER	RONDELLA	RONDELLE	1
3	REC13980	22-806608A1	RACORD COLECTOR	STRAIGHT DRAIN KIT	RACCORDO COLLETTORE	RACCORD COLLECTEUR	1
4	REC27-815528	27-815528	JUNTA COLECTOR	GASKET EXHAUST MANIFOLD	GUARNIZIONE COLLETTORE	JOINT COLLECTEUR	1
	MAR076	12076A2	CODO ESCAPE	EXHAUST ELBOW	GOMITO DI SCARICO	COUDE D'ÉCHAPPEMENT	1
5	SED3092610	12076A2	CODO ESCAPE INOX	EXHAUST ELBOW STAINLESS STEEL	GOMITO DI SCARICO INOX	COUDE D'ÉCHAPPEMENT INOX.	1
6	REC27-99777Q02	27-99777Q02	JUNTA CODO ESCAPE A COLECTOR	GASKET EXHAUST MANIFOLD TO ELBOW	GUARNIZIONE COLLETTORE A GOMITO	JOINT COLLECTEUR À COUDE D'ÉCHAPPEMENT	1
7	REC22-32803	22-32803	TAPÓN	CAP	TAPPO	BOUCHON	1
8	REC860235A03	860235A03	COLECTOR ESCAPE	EXHAUST MANIFOLD	COLLETTORE DI SCARICO	COLLECTEUR D'ÉCHAPPEMENT	1
9	GS38320	54-815504256	ABRAZADERA FUELLE 4"	CLAMP 4"	FASCETTA 4"	COLLIER 4"	2
10	REC32-44348001	32-44348001	FUELLE CODO ESCAPE 4"	EXHAUST BELLOW 4"	CUFFIA GOMITO DI SCARICO 4"	SOUFFLET COUDE D'ÉCHAPPEMENT 4"	1
11	REC27-8079821	27-8079821	JUNTA CARBURADOR MERCAB (NO TKS)	CARBURATOR GASKET MERCAB (NO TKS)	GUARNIZIONE CARBURATORE MERCAB (NO TKS)	JOINT CARBURATEUR MERCAB (NO TKS)	1
12	REC13-35048	21-20553	ARANDELA	WASHER	RONDELLA	RONDELLE	5
13	REC10-53728	10-53728	TORNILLO	SCREW	VITE	VIS	2
14	REC16-806300	16-806300	ESPARRAGO	STUD	PRIGIONIERO	GOIJON	3
15	REC46335	46335	TUERCA	FLANGE SERRATED NUT	DADO	ÉCROU	3
16	HOT20975-MK		KIT MONTAJE	MOUNTING KIT	KIT DI MONTAGGIO	KIT DE MONTAGE	

3.0L MPI

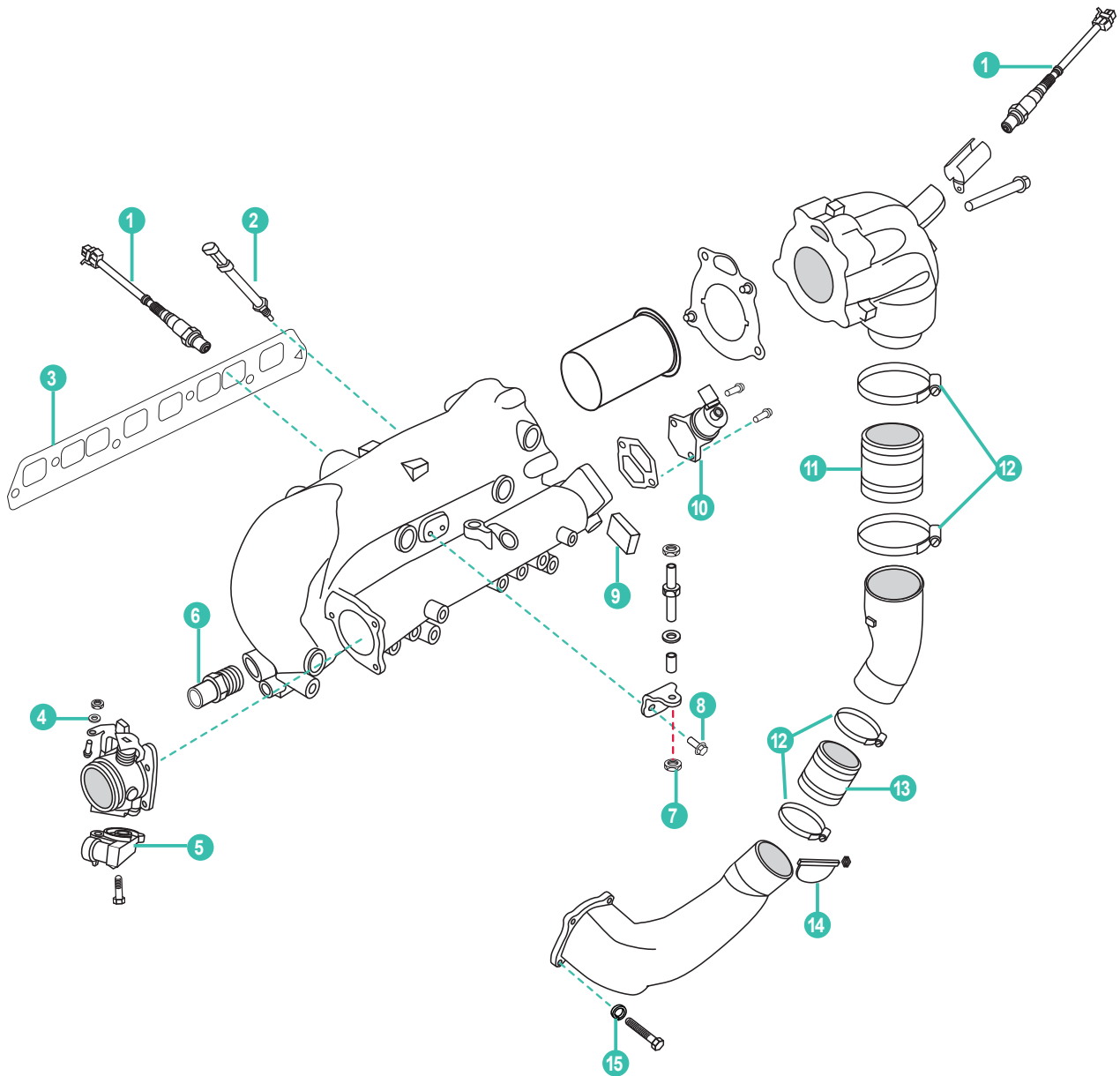

	REF	OEM					UN.
1	REC8M2003959	8M2003959	SENSOR DE OXÍGENO	OXIGEN SENSOR	SENSORE OSSIGENO	SENSEUR OXIGENE	2
2	REC8M0148668	8M0148668	SENSOR TEMPERATURA	TEMPERATURE SENSOR	SENSORE TEMPERATURA	SONDE TEMPERATURE	1
3	REC27-815528	27-815528	JUNTA COLECTOR ESCAPE	MANIFOLD GASKET	GUARNIZIONE COLLETTORE SCARICO	JOINT DE COLLECTEUR D'ÉCHAPPEMENT	1
4	REC13-35048	13-35048	ARANDELA	WASHER	RONDELLA	RONDELLE	1
5	REC8M0125617	8M0125617	SENSOR DE POSICIÓN	POSITION SENSOR	SENSORE POSIZIONE	SENSEUR POSITION	1
6	REC22-866725	22-866725	RACORD COLECTOR	STRAIGHT FITTING	RACCORDO COLLETTORE	RACCORD COLLECTEUR	1
7	REC11-8267089	11-8267089	TUERCA	NUT	DADO	ÉCROU	1
8	REC10-816928	10-816928	TORNILLO M6X16	SCREW M6X16	VITE M6X16	VIS M6X16	2
9	REC35-865266	35-865266	FILTRO	FILTER	FILTRO	FILTRE	1
10	REC862998	862998	VÁLVULA AIRE IDLE	VALVE IDLE AIRE	VALVOLA IDLE ARIA	SOUPEAU IDLE AIR	1
11	REC32-44348001	32-44348001	TUBO ESCAPE	TUBE EXHASUT	TUBO SCARICO	TUYAU ÉCHAPPEMENT	1
12	GS38320	54-815504272	ABRAZADERA	CLAMP	FASCETTA	COLLIER	8
13	REC32-90949T	32-90949T	TUBO ESCAPE	TUBE EXHAUST	TUBO SCARICO	TUYAU ÉCHAPPEMENT	1
14	REC60930	60930	PALOMILLA ESCAPE	SHUTTER WATER EXHAUST	FARFALLA SCARICO	CLAPET ÉCHAPPEMENT	1
15	PAGB/T93-10	13-41471	ARANDELA	LOCKWASHER	RONDELLA	RONDELLE	4

165, 170, 180, 190, 470, 485, 488
3.7L & 3.7LX MCM 224 CID 4 CYL (1980-89)

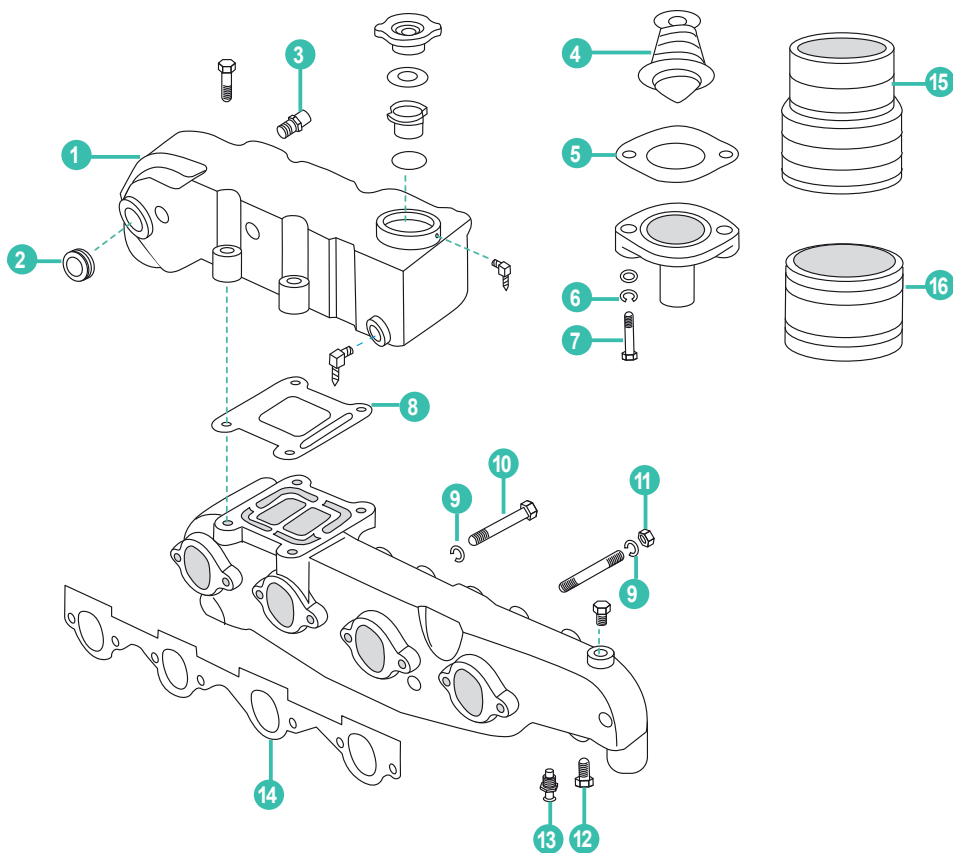
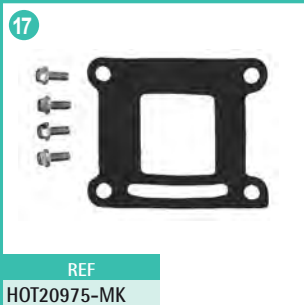

	REF	OEM				UN.	
1	HOT20937	98562A6	CODO PARA COLECTOR ALUMINIO	EXHAUST ELBOW FOR ALUM. MANIFOLD	GOMITO PER COLLETTORI IN ALLUMINO	COUDE D'ÉCHAPPEMENT AL	1
	HOT20905	90880A2	CODO PARA COLECTOR HIERRO	ELBOW FOR CAST. MANIFOLD	GOMITO PER COLLETTORI IN GHISA	COUDE D'ÉCHAPPEMENT FE	1
2	REC22-428611	22-428611	TAPÓN	CAP	TAPPO	BOUCHON	1
3	REC22-866725	22-866725	RACOR COLECTOR	HOSE FITTING	RACCORDO COLLETORE	RACCORD COLLECTEUR	1
4	REC99155T2	99155T2	TERMOSTATO	THERMOSTAT	TERMOSTATO	THERMOSTAT	1
5	REC27-89656-1	27-896561	JUNTA	GASKET	GUARNIZIONE	JOINT	1
6	REC13-39107	13-39107	ARANDELA	LOCKWASHER	CHIUSURA	RONDELLE	2
7	REC10-73657	10-73657	TORNILLO	SCREW	VITE	VIS	2
8	REC27-18272	27-18272	JUNTA CODO A COLECTOR	GASKET - ELBOW TO MANIFOLD	GUARNIZIONE COLLETORE	JOINT COUDE À COLLECTEUR	1
	REC27-856705	27-856705	JUNTA COLECTOR DE HIERRO	GASKET FOR IRON MANIFOLD	GOMITO GUARNIZIONE PER COLLETORE IN GHISA	JOINT COLLECTEUR FE	1
9	REC13-35048	13-35048	ARANDELA	LOCKWASHER	RONDELLA	RONDELLE	3
10	REC22-73379	10-74727	TORNILLO	SCREW	VITE	VIS	3
11	REC46335	46335	TUERCA	FLANGE SERRATED NUT	DADO	ÉCROU	1
12	REC22-32803	22-32803	TAPÓN	PLUG	TAPPO	BOUSCHON	1
13	REC15995	15995	SENSOR TEMPERATURA	TEMPERATURE SENDER	SENSORE TEMPERATURA	SONDE TEMPÉRATURE	1
14	REC27-68715	27-68715	JUNTA COLECTOR ESCAPE	GASKET - EXHAUST MANIFOLD	GUARNIZIONE COLLETORE SCARICO	JOINT COLLECTEUR D'ÉCHAPPEMENT	1
15	REC70981A3	70981A3	FUELLE ESCAPE	EXHAUST BELLOW	CUFFIA SCARICO	SOUFFLET D'ÉCHAPPEMENT	1
16	REC32-90949T	32-90949T	FUELLE ESCAPE	EXHAUST BELLOW	CUFFIA SCARICO	SOUFFLET D'ÉCHAPPEMENT	1
17	HOT20975-MK		KIT PARA COLECTOR DE FUNDICIÓN	KIT FOR CAST IRON MANIFOLD	KIT VITERIA PER COLLETTORI IN GHISA	KIT DE MONTAGE FE FORGÉ	
18	HOT20905-MK		KIT MONTAJE CODO	MOUNTING KIT ELBOW	KIT DI MONTAGGIO GOMITO	KIT DE MONTAGE COUDE	
			HOT20905	HOT20905	HOT20905	HOT20905	
19	HOT20937-MK		KIT MONTAJE CODO	MOUNTING KIT ELBOW	KIT DI MONTAGGIO GOMITO	KIT DE MONTAGE COUDE	
			HOT20937	HOT20937	HOT20937	HOT20937	

GM 160, 165, 200CID, 250, 292CID
6 CYL IN LINE

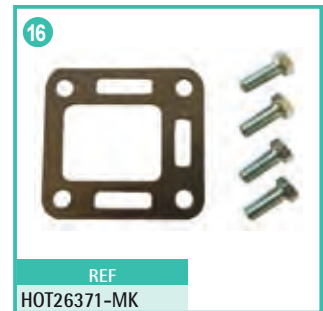
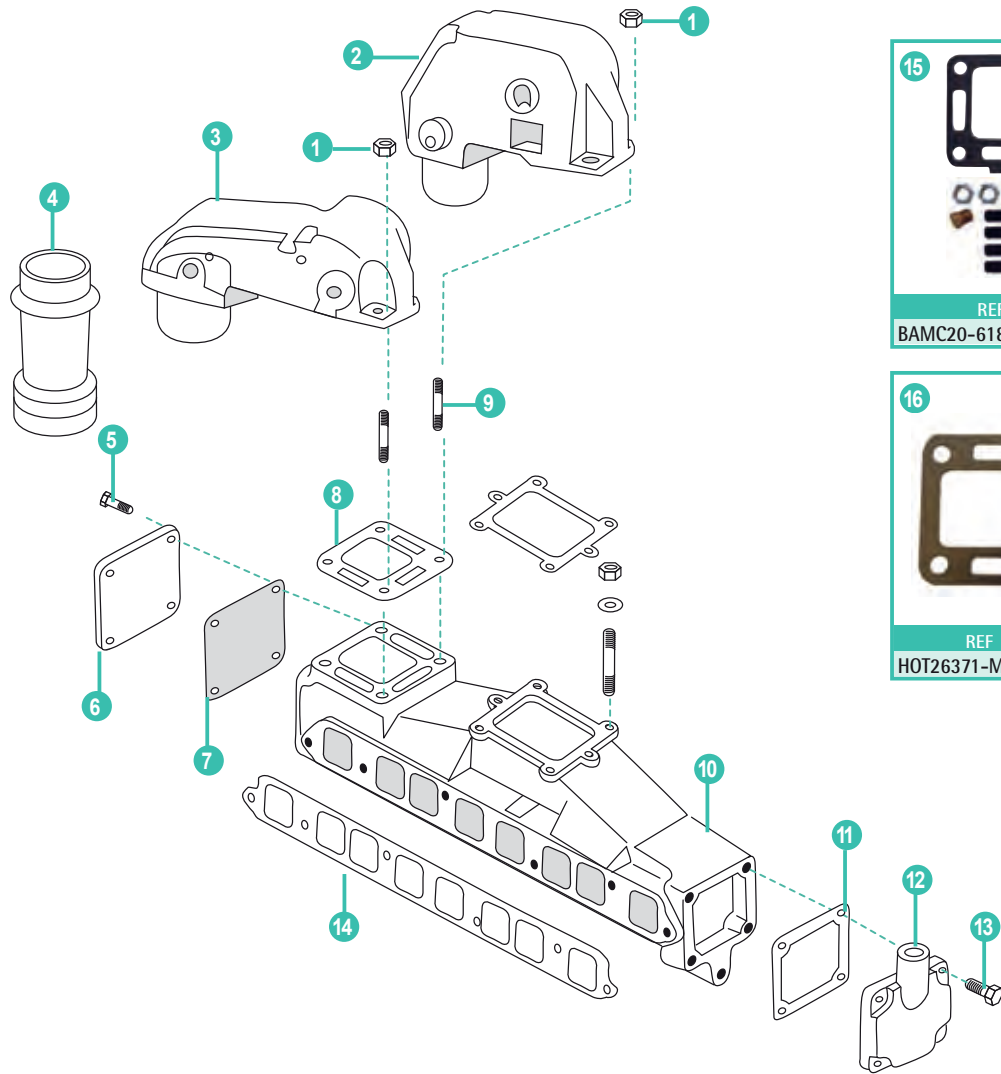

	REF	OEM				UN.	
1	REC46335	46335	TUERCA	NUT	DADO	ÉCROU	4
2	HOT20971	76351A04	CODO ESCAPE 90° 3"	EXHAUST ELBOW ASSY 3" 90°	GOMITO DI SCARICO 90° 3"	COUDE D'ÉCHAPPEMENT 90° 3"	1
3	REC76325A2	76325A2	CODO ESCAPE 90° 3"	EXHAUST ELBOW ASSY 3" 90°	GOMITO DI SCARICO 90° 3"	COUDE D'ÉCHAPPEMENT 90° 3"	1
4	REC53114A1	53114A1	FUELLE ESCAPE	EXHAUST BELLOW	CUFFIA DI SCARICO	SOUFFLET D'ÉCHAPPEMENT	1
5	RM10-25299	10-824941	TORNILLO	SCREW END CAP	VITE	VIS	4
6	HGE4870	73813A1	TAPA COLECTOR ESCAPE	END CAP EXHAUST MANIFOLD	COPERCHIO COLLETORE SCARICO	COUVERCLE COLLECTEUR D'ÉCHAPPEMENT	1
7	REC27-807218	27-807218	JUNTA TAPA	GASKET END CAP	GUARNIZIONE COPERCHIO	JOINT DE COUVERCLE	1
8	REC27-99777Q02	27-99777Q02	JUNTA COLECTOR A CODO	GASKET EXHAUST MANIFOLD TO ELBOW	GUARNIZIONE INTERMEDIA	JOINT COLLECTEUR À COUDE	1
9	REC16-49545	16-49545	ESPÁRRAGO	STUD	PRIGIONIERO	GOUJON	4
10	BAMC-1-58759	58759A14	COLECTOR ESCAPE	EXHAUST MANIFOLD ASSEMBLY	COLLETORE SCARICO	COLLECTEUR D'ÉCHAPPEMENT	1
11	REC27-480431	27-480431	JUNTA TAPA	GASKET END CAP	GUARNIZIONE COPERCHIO	JOINT COUVERCLE	1
12	REC60252A2	60252A2	TAPA COLECTOR	END CAP EXHAUST MANIFOLD	COPERCHIO COLLETORE	COUVERCLE COLLECTEUR	1
13	REC10-37562	10-37562	TORNILLO	SCREW	VITE	VIS	4
14	FEL17319	27-46401	JUNTA COLECTOR ADMISION/ESCAPE	GASKET INTAKE/EXHAUST MANIFOLD	GUARNIZIONE COLLETORE ASPIRAZIONE / SCARICO	JOINT COLLECTEUR ADMISSION/ÉCHAPPEMENT	1
15	BAMC20-61851A3		KIT SUPLEMENTO CODO DE 76mm	RISE MOUNTING KIT 3"	KIT DISTANZIALI GOMITO DA 76 mm	KIT REHAUSSE 3"	
16	HOT26371-MK		KIT MONTAJE CODO HOT26371	MOUNTING KIT ELBOW HOT26371	KIT DI MONTAGGIO GOMITO HOT26371	KIT MONTAGE COUDE HOT20371	

175, 185, 205, 262 MAG, 4.3L, 4.3LX, 4.3LH, 4.3LXH, 4.3 EFI, 4.3 MPI, GM 262 CID V6

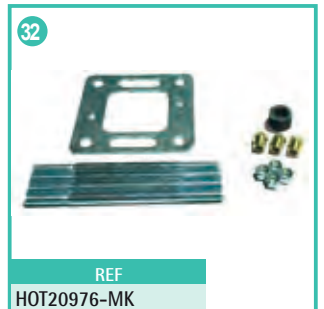
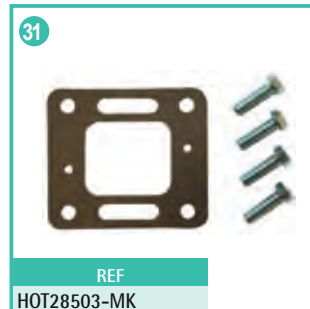
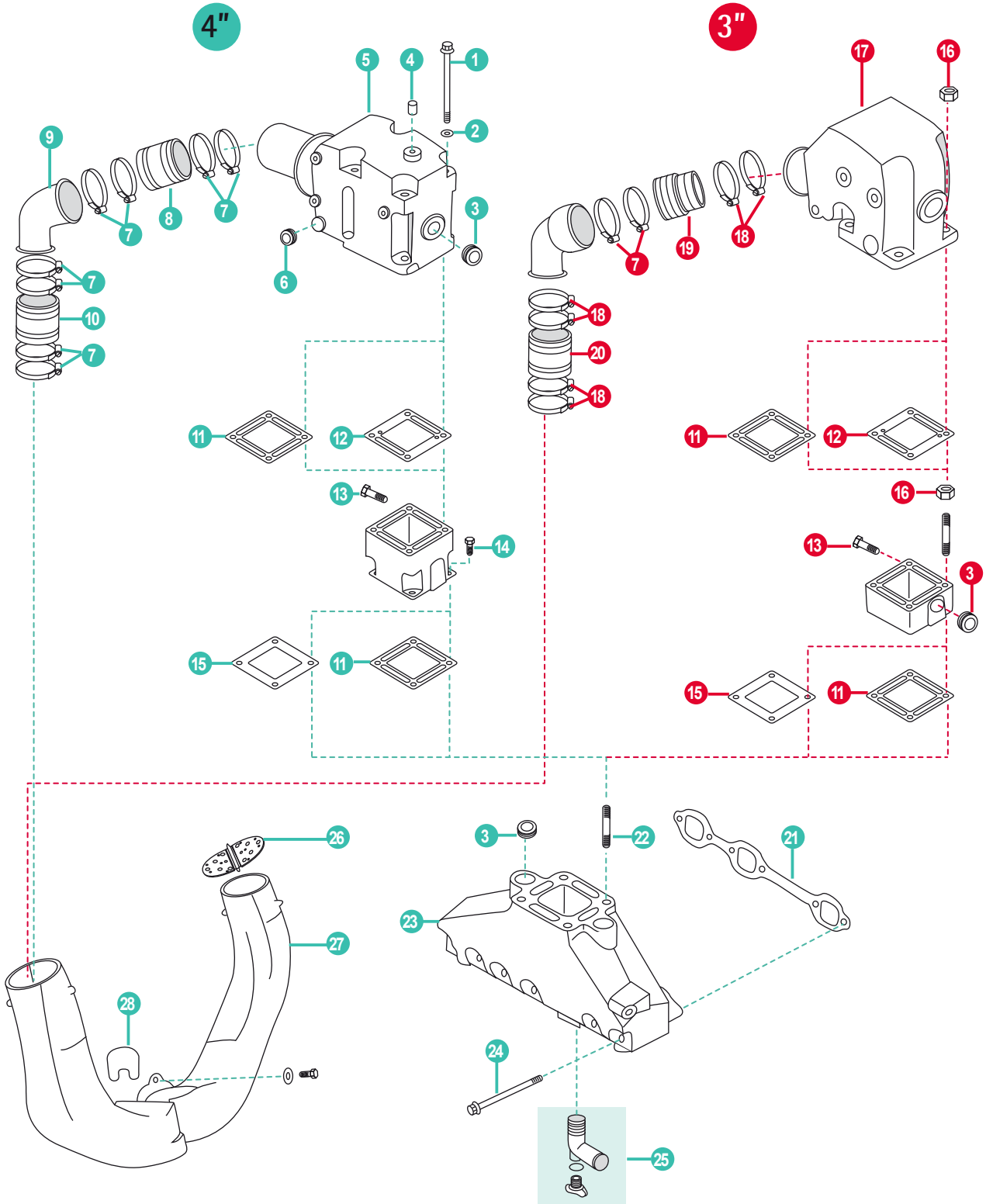

	REF	OEM					UN.
1	REC10-43749	10-43749	TORNILLO	SCREW	VITE	VIS	4
2	REC13-35048	13-35048	ARANDELA CIERRE	LOCKWASHER	CHIUSURA	RONDELLE	4
3	REC22-41622	22-41622	TAPÓN ACERO	PLUG (STEEL)	TAPPO IN ACCIAIO	BOUCHON EN ACIER	2
	REC22-428611	22-428611	TAPÓN BRONCE	PLUG (BRASS)	TAPPO IN BRONZO	BOUCHON EN BRONZE	2
4	REC22-73379	22-73379	TAPÓN	PLUG	TAPPO	BOUCHON	1
5	MAR988	807988A03	CODO 4" 7°	ELBOW 4" 7°	GOMITO 4" 7°	COUDE 4" 7°	1
	SED3092600	807988A3	CODO INOX	ELBOW INOX	GOMITO INOX	COUDE INOX	1
6	REC22-36382	22-36382	TAPÓN	PLUG	TAPPO	BOUCHON	1
7	GS38322	54-815504372	ABRAZADERA	CLAMP	FASCETTA	COLLIER	8
8	REC32-44348001	32-44348001	FUELLE ESCAPE 4"	EXHAUST BELLOW 4"	CUFFIA DI SCARICO 4"	SOUFFLET D'ÉCHAPPEMENT 4"	1
9	BAMC-20-14478	14478T01	TUBO 4"	TUBE 4"	TUBO 4"	TUYAU 4"	1
10	REC32-14358001	32-14358001	FUELLE ESCAPE	EXHAUST BELLOW	CUFFIA DI SCARICO	SOUFFLET D'ÉCHAPPEMENT	1
11	REC27-863726	27-863726	JUNTA	GASKET MANIFOLD	GUARNIZIONE	JOINT COLLECTEUR	1
12	REC27-863724Q	27-863724Q	JUNTA COLECTOR REESTRICTOR	GASKET MANIFOLD FOR RAW WATER	GUARNIZIONE PER CIRCUITO	JOINT DE COUDE D'ÉCHAPPEMENT	1
13	REC22-328022	22-328022	TAPÓN	PLUG	TAPPO	BOUCHON	1
14	REC10-865982005	10-865982005	TORNILLO	SCREW	VITE	VIS	4
15	REC27-8637251	27-8637251	JUNTA COLECTOR CIRCUITO AGUA DULCE	GASKET MANIFOLD FOR FRESH WATER COOLING	GUARNIZIONE PER CIRCUITO CHIUSO	JOINT DE COUDE D'ÉCHAPPEMENT	1
16	REC46335	46335	TUERCA CODO	NUT FLANGE SERRATED NUT	DADO GOMITO	ÉCROU COUDE	4
17	REC98504A3	98504A3	CODO 3" 15°	ELBOW 3" 15°	GOMITO 3" 15°	COUDE 3" 15°	1
18	GS38320	54-815504256	ABRAZADERA	CLAMP	FASCETTA	COLLIER	6
19	REC70981A3	70981A3	FUELLE ESCAPE 3"	EXHAUST BELLOW 3"	CUFFIA DI SCARICO 3"	SOUFFLET D'ÉCHAPPEMENT 3"	1
20	REC32-90949T	32-90949T	FUELLE ESCAPE 3"	EXHAUST BELLOW 3"	CUFFIA DI SCARICO 3"	SOUFFLET D'ÉCHAPPEMENT 3"	1
21	REC27-99757	27-99757	JUNTA COLECTOR	GASKET EXHAUST MANIFOLD	GUARNIZIONE COLLETORE	JOINT COLLECTEUR D'ÉCHAPPEMENT	1
22	REC16-49545	16-49545	ESPARRAGO DE ACERO	STUD (STEEL)	PRIGIONIERO IN ACCIAIO	GOUJON EN ACIER	4
23	MAR746	99746A17	COLECTOR	MANIFOLD	COLLETORE	COLLECTEUR	1
24	REC10-53728	10-53728	TORNILLO	SCREW	VITE	VIS	6
25	REC862210A01	22-862210A01	KIT TAPÓN Y CONDUCTO	HOSE FITTING WITH DRAIN PLUG KIT	KIT TAPPO E CONDOTTO	KIT BOUCHON ET TUBE	1
26	REC807166A1	807166A1	PALOMILLA ESCAPE	WATER SHUTTER	FARFALLA SCARICO	CLAPET ÉCHAPPEMENT	1
27	RM807130A4	807130A4	CUERNOS DE ESCAPE	EXHAUST PIPE	CORNA DI SCARICO	CORNE D'ÉCHAPPEMENT	1
28	REC41802	41802	JUNTA	GASKET	GUARNIZIONE	JOINT	1
29	RECK8503		KIT TORNILLOS CODO	EXHAUST ELBOW MOUNTING KIT	KIT VITI GOMITO	KIT VITI GOMITO	
30	HOT20952-MK		KIT MONTAJE PARA HOT20952	MOUNTING KIT ELBOW HOT20952	KIT MONTAGGIO GOMITO HOT20952	KIT DE MONTAGE HOT20952	
31	HOT28503-MK		KIT MONTAJE PARA HOT20970	MOUNTING KIT ELBOW HOT20970	KIT MONTAGGIO GOMITO HOT20970	KIT DE MONTAGE HOT20970	
32	HOT20976-MK		KIT MONTAJE PARA MAR988	MOUNTING KIT ELBOW MAR988	KIT MONTAGGIO GOMITO MAR988	KIT DE MONTAGE MAR988	
33	REC32175		KIT TORNILLOS Y JUNTAS COLECTOR V6	EXHAUST MANIFOLD MOUNTING KIT	KIT VITE E GUARNIZIONI COLLETORE V6	KIT VISSERIE COLLECTEUR V6 + JOINT	
34	REC53400		KIT TORNILLOS CODO Y JUNTA	EXHAUST ELBOW MOUNTING KIT	KIT VITI GOMITO	KIT VISSERIE POUR COUDE	
35	HOT20985	93322A12AV	KIT ELEVADOR 152 mm	6" RISER KIT	KIT DISTANZIALE 152mm	KIT REHAUSSE 6"	
36	MAR3320PAR	93320A13	KIT ELEVADOR 76 mm	3" RISER KIT	KIT DISTANZIALE 76 mm	KIT REHAUSSE 3"	

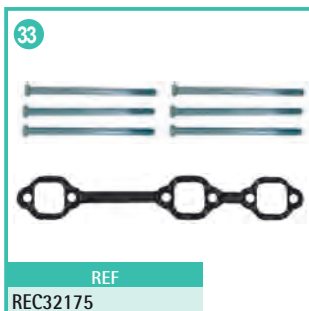

	REF	OEM					UN.
	MAR309	864309T02	CODO BAJO 17 cm	ELBOW LOW 17 cm	GOMITO BASSO 17 cm	COUDE BASSE 17 cm	2
1	MAR591	864591T02	CODO ALTO 20,5 cm	ELBOW HIGH 20,5 cm	GOMITO ALTO 20,5 cm	COUDE HAUT 20,5 cm	2
	SED3095400	864309T02	CODO BAJO INOX	ELBOW LOW SS	GOMITO BASSO INOX	COUDE BASSE INOX	2
	SED3095500	864591T02	CODO ALTO INOX	ELBOW HIGH SS	GOMITO ALTO INOX	COUDE HAUT INOX	2
2	REC22-73379	22-73379	TAPÓN	PLUG	TAPPO	BOUCHON	1
3	REC10-43749	10-43749	TORNILLO	SCREW	VITE	VIS	8
4	REC13-35048	13-35048	ARANDELA	LOCK WASHER	RONDELLA	RONDELLE	8
5	REC22-428611	22-428611	TAPÓN	FITTING	TAPPO	BOUCHON	8
6	REC22-866725	22-866725	RACORD COLECTOR	STRAIGHT FITTING	RACCORD COLLETTORE	RACCORD COLLECTEUR	1
7	REC270	27-684547A02	JUNTA CODO - COLECTOR	ELBOW-MANIFOLD GASKET	GUARNIZIONE INTERMEDIA	JOINT DE COUDE ECHAPPEMENT	1
8	REC19-864689	19-864689	TAPÓN	PLUG	TAPPO	BOUCHON	2
9	GS38310	54-815504456	ABRAZADERA	CLAMP	FASCETTA	COLLIER	8
10	REC32-44348001	32-44348001	FUELLE ESCAPE	EXHAUST BELLOW	MANICOTTO SCARICO	SOUFFLET D'ÉCHAPPEMENT	2
11	GS38320	54-815504456	ABRAZADERA	CLAMP	FASCETTA	COLLIER	8
12	REC32-14358001	32-14358001	FUELLE ESCAPE COLECTOR	EXHAUST BELLOW	MANICOTTO SCARICO COLLETTORE	SOUFFLET D'ÉCHAPPEMENT COLLECTEUR	2
13	REC10-98794	10-98794	TORNILLO	SCREW COVER	VITE	VIS	4
14	REC807166A1	807166A1	PALOMILLA ESCAPE	WATER SHUTTER	FARFALLA SCARICO	CLAPET ÉCHAPPEMENT	2
15	REC41802	41802	RETÉN TRANSON	TRANSON GASKET	GUARNIZIONE TRANSON	JOINT DE TRANSON	1
16	RM807130A4	807130A4	CUERNOS DE ESCAPE	EXHAUST PIPE	CORNA DI SCARICO	CORNE D'ÉCHAPPEMENT	1
17	REC10-53728	10-53728	TORNILLO	SCREW	VITE	VIS	6
18	PAF15-07010004	479452	TAPÓN 1/8"	PLUG 1/8"	TAPPO 1/8"	BOUCHON 1/8"	1
19	REC862210A01	22-862210A01	KIT TAPÓN Y CONDUCTO	ELBOW AND PLUG KIT	KIT TAPPO E TUBO	COUDE DRAIN POUR COLLECTEUR	1
20	REC22-863786A1		CONECTOR	DRAIN FITTING	CONNETTORE	CONNECTEUR T	
21	MAR612	864612T01	COLECTOR	MANIFOLD	COLLETTORE	COLLECTEUR	2
22	REC27-99757	27-99757	JUNTA COLECTOR	MANIFOLD GASKET	GUARNIZIONE COLLETTORE	JOINT COLLECTEUR	2
23	RECK309		KIT TORNILLOS CODO Y JUNTA	ELBOW GASKET & BOLT KIT	KIT VITERIA GOMITO E GUARNIZIONE	KIT DE MONTAGE	
24	REC270		KIT JUNTA CODO-COLECTOR	ELBOW-MANIFOLD GASKET	GUARNIZIONE GOMITO-COLLETTORE	JOINT DE COUDE ECHAPPEMENT	
25	RECK591		KIT PARA MAR591	KIT FOR MAR591	KIT PER MAR591	KIT POUR MAR591	
26	REC32175		KIT TORNILLOS COLECTOR Y JUNTA	MANIFOLD GASKET & ELBOW KIT	KIT VITERIA COLLETTORE E GUARNIZIONE	KIT VISSERIE COLLECTEUR V6 + JOINT	
27	MAR929 HGE4929	864929A3	KIT RISER 3"	KIT RISER 3"	KIT GOMITO 3"	KIT REHAUSSE 3"	
28	BAMC-20-864908A1	864908A1	KIT RISER 6"	KIT RISER 6"	KIT GOMITO 6"	KIT REHAUSSE 6"	

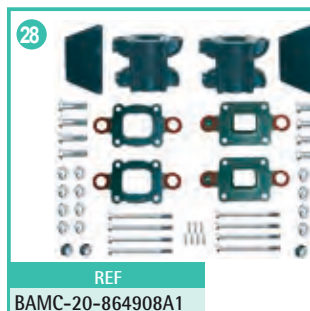

262 MAG (TBI), 4.3L (GEN+), 4.3 L EFI (GEN+), 4.3 LH (GEN+), 4.3LX (GEN+), GM 262 V6 (1996-01)

PIEZAS NECESARIAS PARA
SUBSTITUIR EL COLECTOR-CODO
PARA V6

NEEDS PARTS TO REPLACE V6
MANIFOLD-ELBOW

PEZZI NECESSARI PER SOSTITUIRE IL
COLLETTORE PER V6

PIÈCES NÉCESSAIRES POUR
REMPLACER LE COLLECTEUR-COUDE
POUR V6

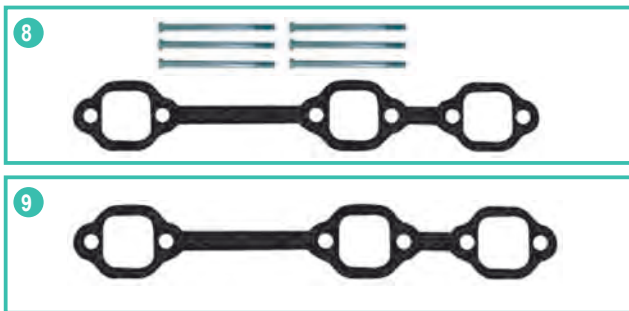

	REF	OEM					UN.
1	MAR988	807988A03	CODO 4"	ELBOW 4"	GOMITO 4"	COUDE 4"	2
2	REC32-44348001	32-44348001	FUELLE ESCAPE SUPERIOR	UPPER EXHAUST BELLOW	CUFFIA SCARICO SUPERIORE	SOUFFLET ECHAPPEMENT SUPERIEUR	2
3	REC32-14358001	32-14358001	FUELLE ESCAPE INFERIOR	LOWER EXHAUST BELLOW	CUFFIA SCARICO INFERIORE	SOUFFLET ECHAPPEMENT INFÉRIEUR	2
4	MAR746	99746A17	COLECTOR	MANIFOLD	COLLETTORE	COLLECTEUR	2
5	BAMC-20-14478	14478T01	CURVA ESCAPE V6	EXHAUST ELBOW ASSY	CURVA SCARICO V6	COUDE DE CONVERSION V6/262	2
6	REC862210A01	22-862210A01	KIT TAPÓN Y CONDUCTO	HOSE FITTING W/DRAIN PLUG KIT	KIT RUBINETTO	COUDE DRAIN POUR COLLECTEUR	2
7	GS38322	54-815504372	ABRAZADERA INOX	INOX CLAMP	FASCETTA INOX	COLLIER INOX	8
8	REC32175		KIT JUNTA Y TORNILLOS	GASKETS & BOLTS KIT	KIT VITERIA E GUARNIZIONI	KIT VISSERIE COLLECTEUR V6 + JOINT	2
9	REC27-99757	27-99757	JUNTA COLECTOR (X1)	MANIFOLD'S GASKET (X1)	GUARNIZIONE (X1)	KIT JOINTS COLLECTEUR ECHAPPEMENT (X1)	2
10	REC53400		KIT JUNTAS CODOS Y TORNILLOS	BOLTS & ELBOWS GASKETS KITS	KIT VITERIA E GUARNIZIONI	KIT VISSERIE POUR COUDE MAR988	2

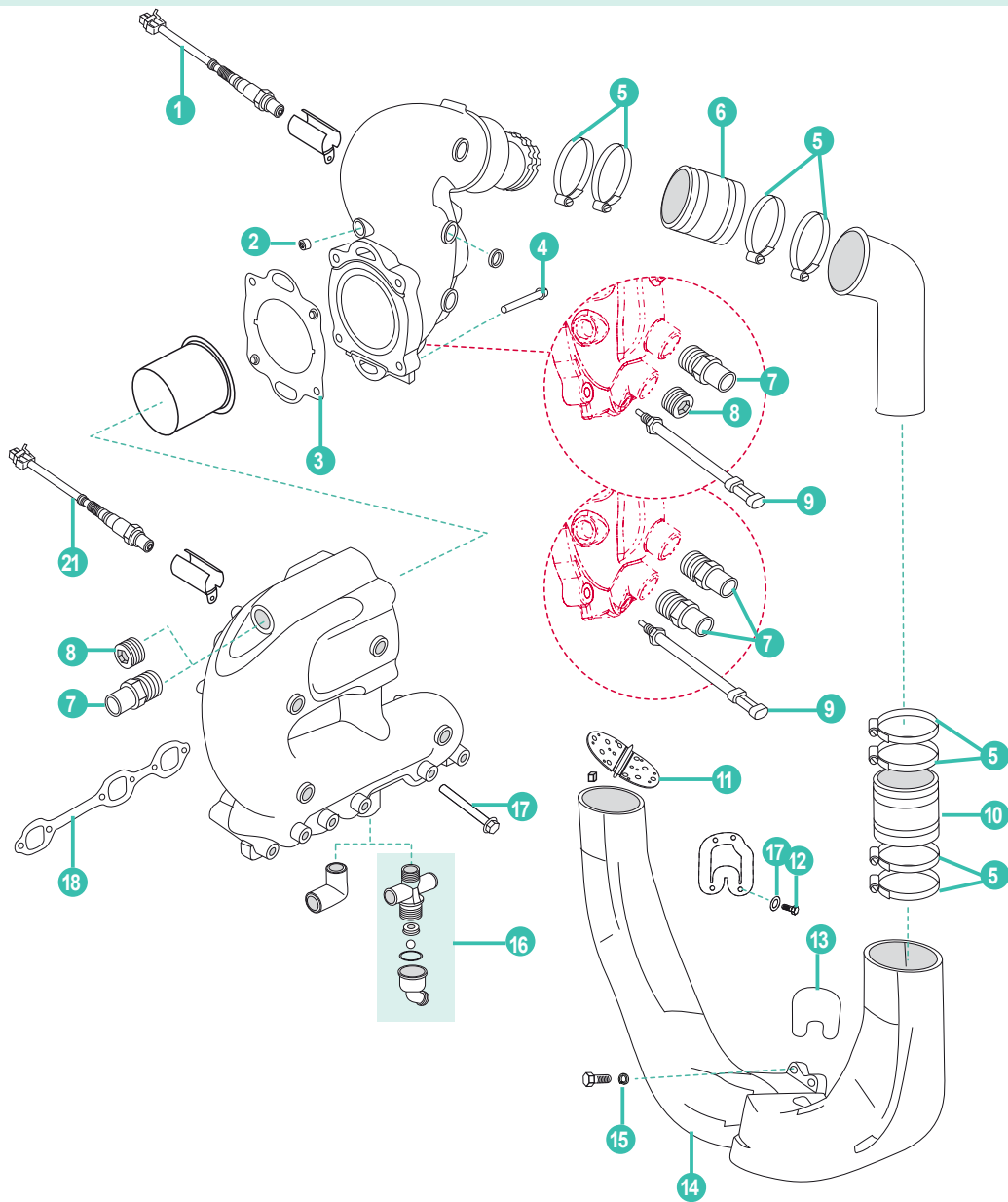

	REF	OEM				UN.	
1	REC8M2003959	8M2003959	SENSOR OXÍGENO	OXYGEN SENSOR	SENSORE O2	SENSEUR O2	2
2	REC22-73379	73379	TAPÓN	PLUG	TAPPO	BOUCHON	
3	REC8M2004414	8M2004414	JUNTA (STANDARD COOLING)	GASKET	GUARNIZIONE	JOINT	2
4	REC10-668631	668631	TORNILLO	SCREW	VITE	VIS	4
5	GS38320	815504272	ABRAZADERA	CLAMP	FASCETTA	COLLIER	16
6	REC32-44348001	44348001	TUBO ESCAPE	EXHAUST TUBE	TUBO SCARICO	DURITE D'ÉCHAPPEMENT	2
7	REC22-866725	866725	RACOR COLECTOR	FITTING STRAIGHT	RACCORDO COLLETTORE	RACCORD COLLECTEUR	2 (3)
8	REC22-428611	428611	TAPON CODO LATON	FITTING PIPE. BRASS	TAPPO GOMITO OTTONE	BOUCHON DE COUDE EN LAITON	2
9	REC8M0148668	885342002	SENSOR	SENDER	SENSORE	SENSEUR	2
10	REC32-14358001	14358001	TUBO ESCAPE	EXHAUST TUBE	TUBO SCARICO	DURITE D'ÉCHAPPEMENT	2
11	REC807166A1	807166A1	PALOMILLA	SHUTTER ASSY WATER	FARFALLA	CLAPET	2
12	REC10-98794	98794	TORNILLO	SCREW	VITE	VIS	4
13	REC41802		JUNTA	GASKET	GUARNIZIONE	JOINT	1
14	RM807130A4	8M0115149	CUERNO ESCAPE	PIPE EXHAUST	CORNA DI SCARICO	CORNE D'ÉCHAPPEMENT	1
15	PAGB/T93-10	41471	ARANDELA	LOCKWASHER	RONDELLA	RONDELLE	8
16	REC8M0095953	8M0095953	CONECTOR	FITTING ASSY (STD COOLING)	CONNECTOR	CONNECTEUR	2
17	REC10-53728	8M2000229	TORNILLO	SCREW	VITE	VIS	6
18	REC27-99757	99757	JUNTA	GASKET	GUARNIZIONE	JOINT	1
19	REC8M0142695	8M0095468	SENSOR OXÍGENO	OXYGEN SENSOR	SENSORE O2	SENSEUR O2	2

305, 350, 377, 383, 385, (6.2L)
MAG MPI HORIZON ALPHA/BRAVO

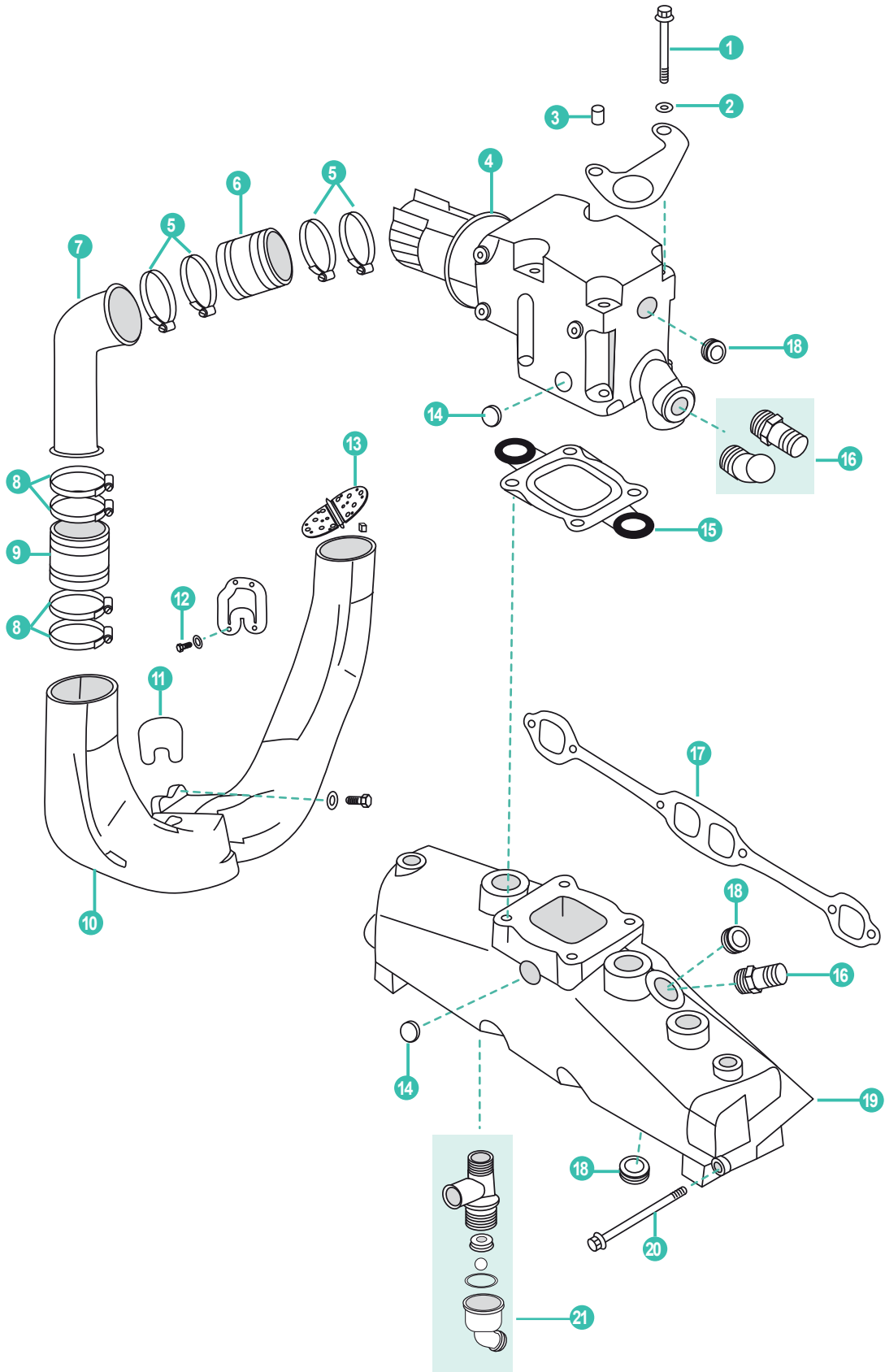

	REF	OEM					UN.
1	REC10-43749	10-43749	TORNILLO	SCREW	VITE	VIS	8
2	REC13-35048	13-35048	ARANDELA	WASHER	RONDELLA	RONDELLE	8
3	REC22-73379	22-73379	TAPÓN	PLUG	TAPPO	BOUCHON	1
	MAR309	864309T02	CODO BAJO 17 cm	ELBOW LOW 17 cm	GOMITO BASSO 17 cm	COUDE BASSE 17 cm	2
4	MAR591	864591T02	CODO ALTO 20,5 cm	ELBOW HIGH 20,5 cm	GOMITO ALTO 20,5 cm	COUDE HAUTE 20,5cm	2
	SED3095400	864309T02	CODO BAJO INOX	ELBOW LOW SS	GOMITO BASSO INOX	COUDE BASSE INOX	2
	SED3095500	864591T02	CODO ALTO INOX	ELBOW HIGH SS	GOMITO ALTO INOX	COUDE HUATE INOX	2
5	GS38310	54-815504456	ABRAZADERA	CLAMP	FASCETTA	COLLIER	8
6	REC32-44348001	32-44348001	FUELLE ESCAPE	EXHAUST BELLOW	MANICOTTO SCARICO	SOUFFLER ÉCHAPPEMENT	2
7	RM14801A1	14801A1	KIT SUPLEMENTOS	KIT RISER	KIT DISTANZIALE	KIT HAUSSEUR	1
8	GS38320	54-815504272	ABRAZADERA	CLAMP	FASCETTA	COLLIER	8
9	REC32-14358001	32-14358001	FUELLE ESCAPE COLECTOR	EXHAUST BELLOW	MANICOTTO SCARICO COLLETORE	SOUFFLET ÉCHAPPEMENT COLLECTEUR	2
10	RM807130A4	807130A4	CUERNOS DE ESCAPE	EXHAUST PIPE	CORNA DI SCARICO	CORNE D'ÉCHAPPEMENT	1
11	REC41802	41802	RETÉN TRANSOM	TRANSOM GASKET	GUARNIZIONE TRANSOM	JOINT TRANSOM	1
12	REC10-98794	10-98794	TORNILLO	SCREW COVER	VITE	VIS	4
13	REC807166A1	807166A1	PALOMILLA ESCAPE	WATER SHUTTER	FARFALLA SCARICO	CLAPET ÉCHAPPEMENT	2
14	REC19-864689	19-864689	TAPÓN	PLUG	TAPPO	BOUCHON	6
15	REC270		JUNTA CODO - COLECTOR	ELBOW-MANIFOLD GASKET	GUARNIZIONE INTERMEDIA	JOINT COUDE - COLLECTEUR	1
16	REC22-866725	22-866725	RACORD COLECTOR	STRAIGHT FITTING	RACCORD COLLETORE	RACCORD COLLECTEUR	1
	REC27-33395	27-33395	JUNTA COLECTOR	MANIFOLD GASKET	GUARNIZIONE COLLETORE	JOINT COLLECTEUR	2
17	FEL17420	27-33395	KIT JUNTAS COLECTOR	MANIFOLD GASKET KIT	KIT GUARNIZIONE COLLETORE	KIT JOINTS COLLECTEUR	1
18	REC22-428611	22-428611	TAPÓN	PLUG	TAPPO	BOUCHON	4
19	MAR735	865735A02	COLECTOR	MANIFOLD	COLLETORE	COLLECTEUR	2
20	REC10-53728	10-53728	TORNILLO	SCREW	VITE	VIS	8
21	REC22-863786A1	22-863786A1	CONECTOR	FITTING	CONNECTOR	CONNECTEUR	
22	RECK309		KIT TORNILLOS CODO Y JUNTA	ELBOW GASKET & BOLT KIT	KIT VITERIA GOMITO E GUARNIZIONE	KIT DE MONTAGE	
23	REC270	27-864547A02	KIT JUNTA CODO-COLECTOR	ELBOW-MANIFOLD GASKET	GUARNIZIONE GOMITO-COLLETORE	JOINT DE COUDE ÉCHAPPEMENT	
24	RECK591		KIT PARA MAR591	KIT FOR MAR591	KIT PER MAR591	KIT POUR MAR591	
25	MAR929 HGE4929	864929A3	KIT RISER 3"	KIT RISER 3"	KIT GOMITO 3"	KIT REHAUSSE 3"	
26	BAMC-20-864908A1	864908A1	KIT RISER 6"	KIT RISER 6"	KIT GOMITO 6"	KIT REHAUSSE 6"	

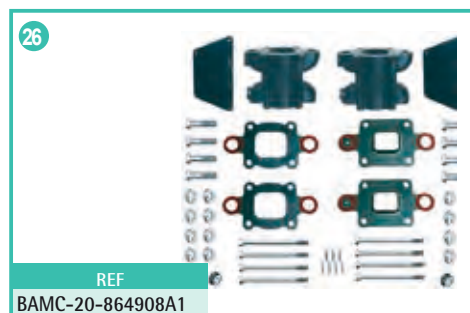

V8 SMALL BLOCK

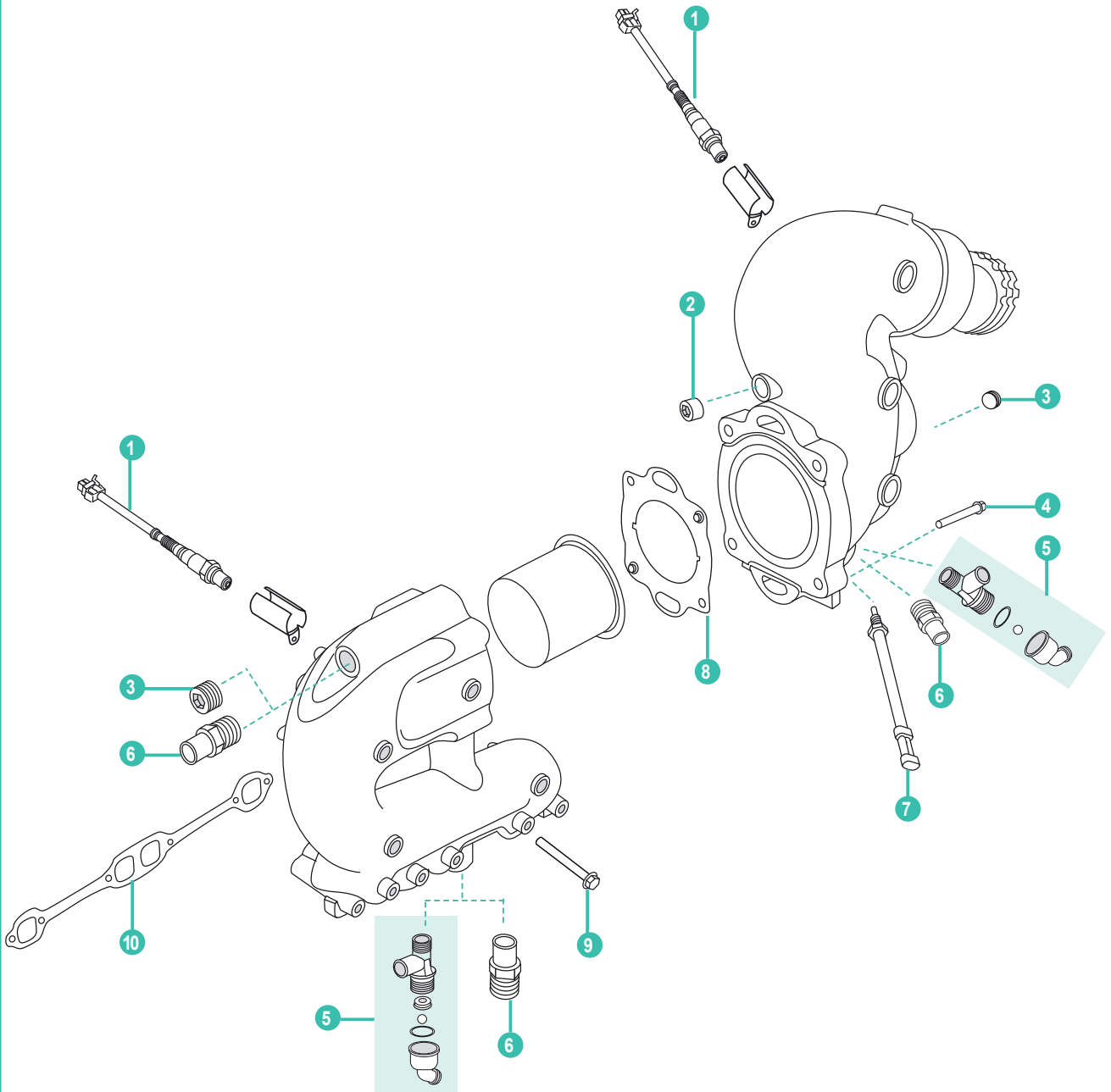

	REF	OEM					UN.
1	REC8M2003959	8M2003959	SENSOR OXÍGENO	O2 SENSOR	SENSORE O2	SENSEUR O2	4
2	REC22-73379	73379	TAPON	PLUG	TAPPO	BOUCHON	
3	REC22-428611	428611	TAPON CODO LATON	FITTING PIPE-BRASS	TAPPO GOMITO OTTONE	BOUCHON DE COUDE EN LAITON	2
4	REC10-668631	668631	TORNILLO	SCREW	VITE	VIS	8
5	REC22-863786A1	863786A1	CONECTOR	T FITTING ASSY	CONNETTORE	CONNECTEUR T	2
6	REC22-866725	866725	RACORD COLECTOR	FITTING STRAIGHT	RACCORD COLLETORE	RACCORD COLLECTEUR	2
7	REC8M0148668	885342002	SENSOR	SENSOR ASSY	SENSORE	SENSEUR	2
8	REC8M2004414	8M2004414	JUNTA CODO -COLECTOR	GASKET ELBOW-MAIFOLD	GUARNIZIONE GOMITO - COLLETORE	JOINT COUDE - COLLECTEUR	2
9	REC10-53728	8M2000229	TORNILLO	SCREW	VITE	VIS	12
10	REC27-33395	8M2000819	JUNTA COLECTOR ESCAPE	MANIFOLD GASKET	GUARNIZIONE COLLETORE SCARICO	JOINT DE COLLECTEUR D'ECHAPPEMENT	1

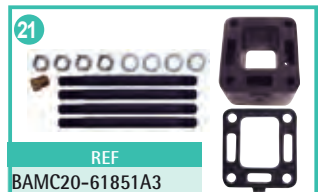
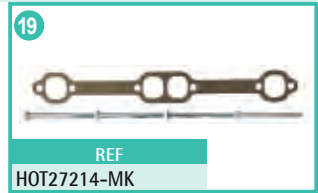
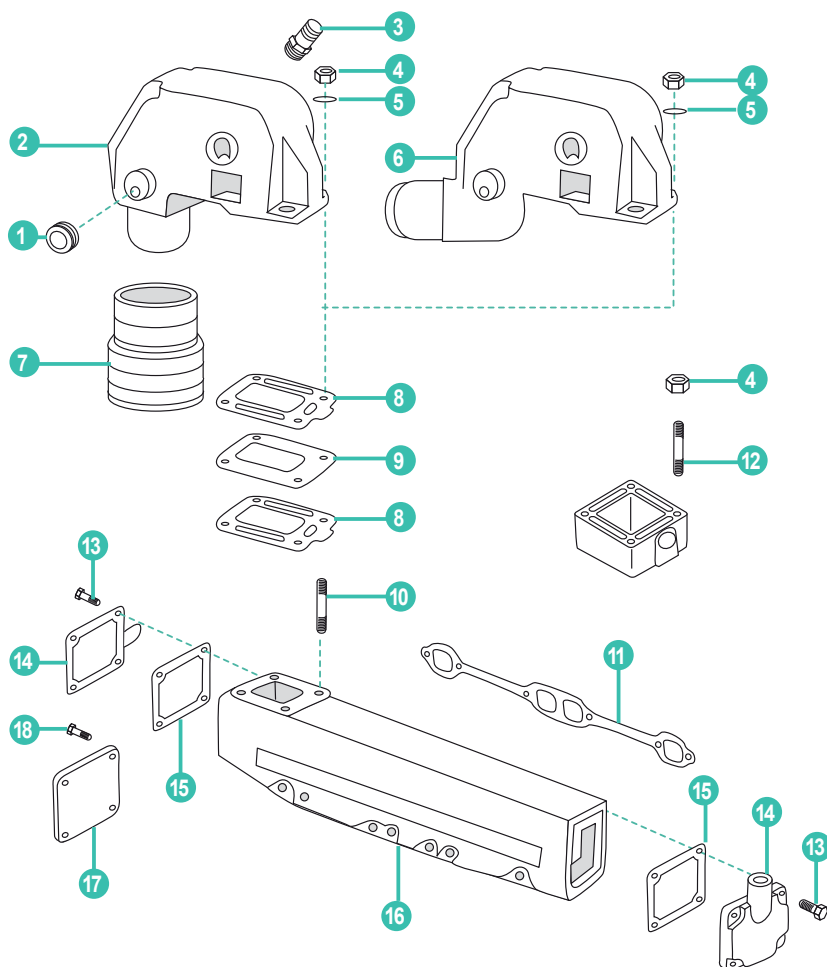

	REF	OEM				UN.	
1	REC22-41622	22-41622	TAPON CODO	ELBOW PLUG	TAPPO GOMITO	BOUCHON COUDE	2
2	HOT20971	76351A04	CODO 90°	EXHAUST ELBOW ASSY. 3" 90°	GOMITO 90°	COUDE 90°	1
3	REC22-866725	22-866725	RACORD COLECTOR	STRAIGHT FITTING	RACCORDO COLLETTORE	RACCORD COLLECTEUR	2
4	REC46335	46335	TUERCA CODO	FLANGE SERRATED NUT	DADO	ÉCROU	4
5	REC13-35048	13-35048	ARANDELA	WASHER	RONDELLA	RONDELLE	4
6	HOT20978 REC76771A2	76771A2	CODO 0°	EXHAUST ELBOW ASSY. 3" 0°	GOMITO 0°	COUDE 0°	1
7	REC70981A3	70981A3	FUELLE ESCAPE	EXHAUST BELOW	MANICOTTO SCARICO	SOUFFLET ÉCHAPPEMENT	2
8	REC27-99777Q02	27-99777Q02	JUNTA CODO	GASKET EXHAUST ELBOW	GUARNIZIONE COPERCHIO	JOINT COUDE	2
9	REC60207	60207	TAPA COLECTOR	PLATE	PIASTRA	PLAQUE DE COLLECTEUR	1
10	REC16-49545	16-49545	ESPÁRRAGO	STUD	PRIGIONIERO	GOUJON	4
11	REC27-33395 FEL17420	27-33395	JUNTA COLECTOR KIT JUNTAS COLECTOR	GASKET EXHAUST MANIFOLD EXHAUST MANIFOLD KIT	GUARNIZIONE COLLETTORE KIT GUARNIZIONI COLLETTORE	JOINT COLLECTEUR KIT JOINTS COLLECTEUR	1
12	REC16-97520	16-97520	ESPÁRRAGO	STUD	PRIGIONIERO	GOUJON	4
13	REC10-35386	10-35386	TORNILLO	SCREW END CAP	VITE	VIS	8
14	REC60252A2	60252A2	TAPA COLECTOR	END CAP EXHAUST MANIFOLD	COPERCHIO COLLETTORE	COUVERCLE COLLECTEUR	2
15	REC27-480431	27-480431	JUNTA TAPA	GASKET END CAP	GUARNIZIONE COPERCHIO	JOINT COUVERCLE	2
16	HOT20950	77234A7	COLECTOR BABOR	EXHAUST MANIFOLD PORT	COLLETTORE DI SINISTRA	COLLECTEUR D'ÉCHAPPEMENT	1
17	HGE4870	73813A1	TAPA COLECTOR	END CAP EXHAUST MANIFOLD	COPERCHIO COLLETTORE	COUVERCLE COLLECTEUR	1
18	RM10-25299	10-824941	TORNILLO	SCREW END CAP	VITE	VIS	4
19	HOT27214-MK		KIT TORNILLOS CODO Y JUNTA	ELBOW GASKET & BOLT KIT	KIT VITERIA GOMITO E GUARNIZIONE	KIT DE MONTAGE ET JOINT	
20	HOT26371-MK		KIT MONTAJE PARA HOT20971/8	MOUNTING KIT ELBOW HOT20971/8	KIT DI MONTAGGIO GOMITO HOT20971/8	KIT MONTAGE POUR HOT20971/8	
21	BAMC20-61851A3		KIT SUPLEMENTOS 3"	RISER 3"	KIT RISER 3"	KIT HAUSSEUR 3"	

200, 228, 230, 230 MIE, 5.0L, 5.0LX, 898, 5.0L MPI, GM305 CID, 260, 260 MIE, 320 EFI, 350 MAG, GM350 CID, 5.7L, 5.7LX, 6.2L MPI V8 (1983 + 2003)

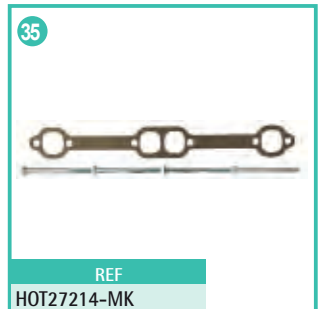
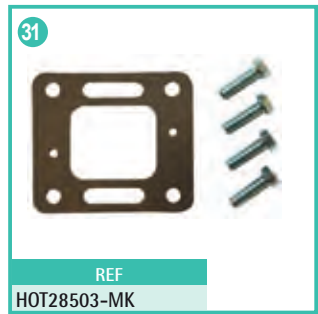
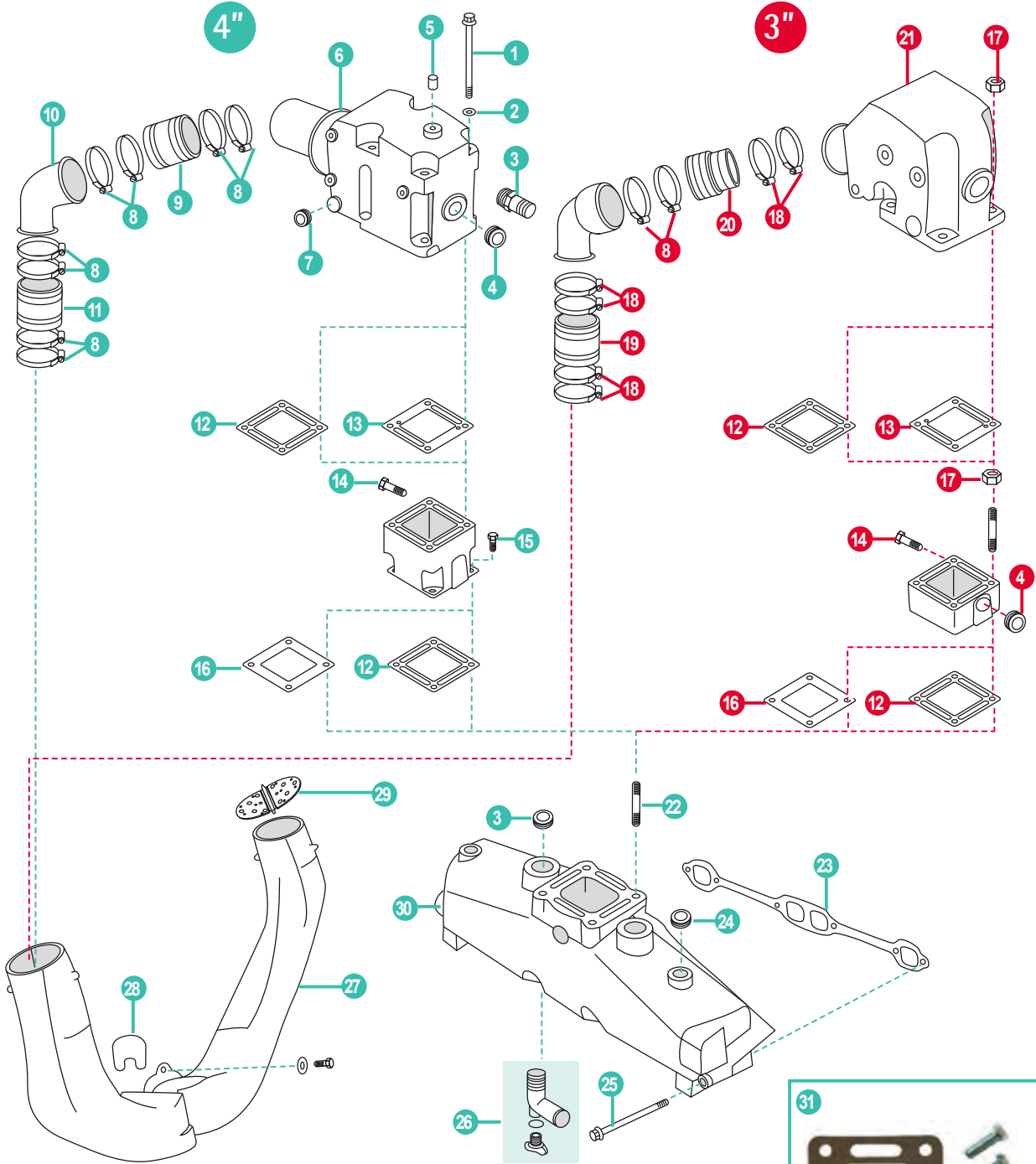

	REF	OEM				UN.	
1	REC10-43749	10-43749	TORNILLO ACERO	SCREW STEEL ZINC PLATED	VITE IN ACCIAIO	BOULON DE COUDE EN ACIER	4
2	REC13-35048	13-35048	CIERRE	LOCKWASHER	CHIUSURA	RONDELLE	4
3	REC22-866725	22-866725	RACORD COLECTOR	STRAIGHT FITTING	RACCORD COLLETORE	RACCORD COLLECTEUR	2
4	REC22-41622	22-41622	TAPÓN ACERO	PLUG (STEEL)	TAPPO IN ACCIAIO	BOUCHON EN ACIER	2
4	REC22-428611	22-428611	TAPÓN BRONCE	PLUG (BRASS)	TAPPO IN BRONZO	BOUCHON EN BRONZE	2
5	REC22-73379	22-73379	TAPÓN	PLUG	TAPPO	BOUCHON	1
6	MAR988	807988A03	CODO HIERRO	ELBOW (IRON CASTING) 4" 7°	GOMITO IN GHISA	COUDE FE 4" 7°	2
6	SED3092600		CODO INOX	ELBOW INOX 4" 7°	GOMITO INOX	COUDE INOX 4" 7°	2
7	REC22-36382	22-36382	TAPÓN	PLUG	TAPPO	BOUCHON	1
8	GS38322	54-815504372	ABRAZADERA	CLAMP	FASCETTA	COLLIER	1
9	REC32-44348001	32-44348001	FUELLE ESCAPE 4"	EXHAUST BELLOW 4"	CUFFIA SCARICO 4"	SOUFFLET ÉCHAPPEMENT 4"	1
10	BAMC-20-14478	14478T01	TUBO	TUBE	TUBO	TUYAU	1
10	RM14801A1	14801A1	KIT SUPLEMENTOS	KIR RISER	KIT DISTANZIALE	KIT HAUSSEUR	1
11	REC32-14358001	32-14358001	FUELLE ESCAPE 4"	EXHAUST BELLOW 4"	CUFFIA SCARICO 4"	SOUFFLET ÉCHAPPEMENT 4"	1
12	REC27-863726	27-863726	JUNTA COLECTOR Y ESPACIADORES	MANIFOLD AND SPACERS	GUARNIZIONE PER DISTANZIALE GASKET	JOINT COLLECTEUR ET HAUSSEURS	1
13	REC27-863724Q	27-863724Q	JUNTA COLECTOR CIRCUITO CERRADO	GASKET MANIFOLD RAW WATER COOLING	GUARNIZIONE COLLETORE CIRCUITO APERTO	JOINT DE COUDE D'ÉCHAPPEMENT	1
14	REC22-328022	22-328022	TAPÓN	CAP	TAPPO	BOUCHON	2
15	REC10-865982005	10-865982005	TORNILLO	SCREW	VITE	VIS	1
16	REC27-8637251	27-8637251	JUNTA COLECTOR CIRCUITO AGUA DULCE	GASKET MANIFOLD FOR FRESH WATER COOLING	GUARNIZIONE COLLETORE CIRCUITO CHIUSO	JOINT COLLECTEUR EAU FRÈICHE	1
17	REC46335	46335	TUERCA CODO	FLANGE SERRATED NUT	DADO GOMITO	ÉCROU COUDE	4
18	GS38320	54-815504256	ABRAZADERA	CLAMP	FASCETTA	COLLIER	1
19	REC32-90949T	32-90949T	FUELLE ESCAPE 3"	EXHAUST BELLOW 3"	CUFFIA SCARICO 3"	SOUFFLET ÉCHAPPEMENT 3"	1
20	REC70981A3	70981A3	FUELLE ESCAPE 3"	EXHAUST BELLOW 3"	CUFFIA SCARICO 3"	SOUFFLET ÉCHAPPEMENT 3"	1
21	REC98504A3	98504A3	CODO HIERRO 3" 15°	ELBOW (IRON CASTING) 3" 15°	GOMITO IN GHISA 3" 15°	COUDE FE 3" 15°	2
22	REC16-49545	16-49545	TORNILLO	STUD (STEEL)	VITE	VIS	1
23	REC27-33395	27-33395	JUNTA COLECTOR	GASKET EXHAUST MANIFOLD	GUARNIZIONE COLLETORE	JOINT COLLECTEUR	2
23	FEL17420	27-33395	KIT JUNTAS	GASKET EXHAUST MANIFOLD	KIT GUARNIZIONI	KIT JOINTS	2
24	REC22-384071	22-384071	TAPÓN	PLUG	TAPPO	BOUCHON	1
25	REC10-53728	10-53728	TORNILLO	SCREW	VITE	VIS	4
26	REC862210A01	22-862210A01	KIT TAPÓN Y CONDUCTO	HOSE FITTING WITH DRAIN PLUG KIT	KIT TAPPO	COUDE DRAIN POUR COLLECTEUR	1
27	RM807130A4	807130A4	CUERNOS DE ESCAPE	EXHAUST PIPE	CORNA DI SCARICO	CORNE D'ÉCHAPPEMENT	1
28	REC41802	41802	RETÉN TRANSOM	TRANSOM GASKET	GUARNIZIONE TRANSOM	JOINT TRANSOM	1
29	REC807166A1	807166A1	PALOMILLA ESCAPE	WATER SHUTTER	FARFALLA SCARICO	CLAPET ÉCHAPPEMENT	2
30	MAR246	860246A15	COLECTOR	MANIFOLD	COLLETORE	COLLECTEUR	2
31	HOT28503-MK		KIT MONTAJE PARA HOT20970	MOUNTING KIT HOT20970	KIT DI MONTAGGIO PER HOT20970	KIT DE MONTAGE POUR HOT20970	
32	RECK8503		KIT TORNILLOS CODO Y JUNTA	EXHAUST ELBOW MOUNTAING KIT	KIT VITI GOMITO	KIT VISSERIE POUR COUDE	
33	REC53400		KIT TORNILLOS CODO Y JUNTA	EXHAUST ELBOW MOUNTAING KIT	KIT VITI GOMITO	KIT VISSERIE POUR COUDE	
34	HOT20976-MK		KIT MONTAJE PARA MAR988	MOUNTING KIT MAR988	KIT DI MONTAGGIO PER MAR988	KIT DE MONTAGE POUR MAR988	
35	HOT27214-MK		KIT PARA MONTAJE PARA /1	MOUNTING KIT /1	KIT DI MONTAGGIO PER /1	KIT DE MONTAGE POUR /1	
36	HOT20985	93322A12AV	KIT RISER 152 mm	KIT RISER 6"	KIT RISER 6"	KIT HAUSSEUR 6"	
37	MAR3320PAR	93320A13	KIT RISER 76 mm	KIT RISER 3"	KIT RISER 3"	KIT HAUSSEUR 3"	
38	REC93320A15	93320A10	KIT RISER 76 mm	KIT RISER 3"	KIT RISER 3"	KIT HAUSSEUR 3"	

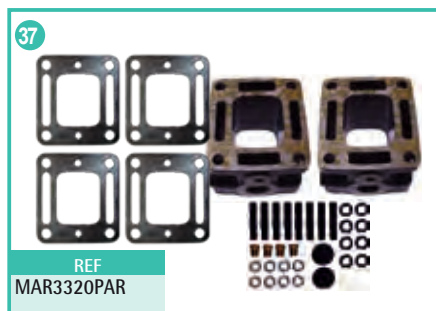

330, 340MIE, 370TRS, 454EFI, 454MAG, 7.4MIE, 7.4L, 7.4LX, GM454 CID V8
502 EFI, 502 MAG, 8.2L, GM502 CID V8

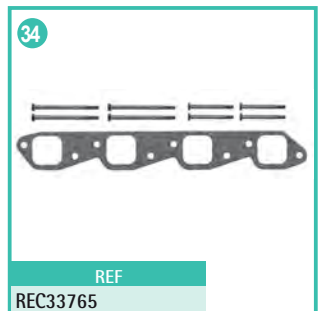
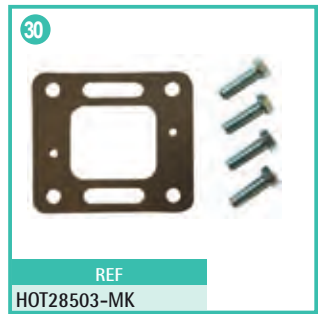
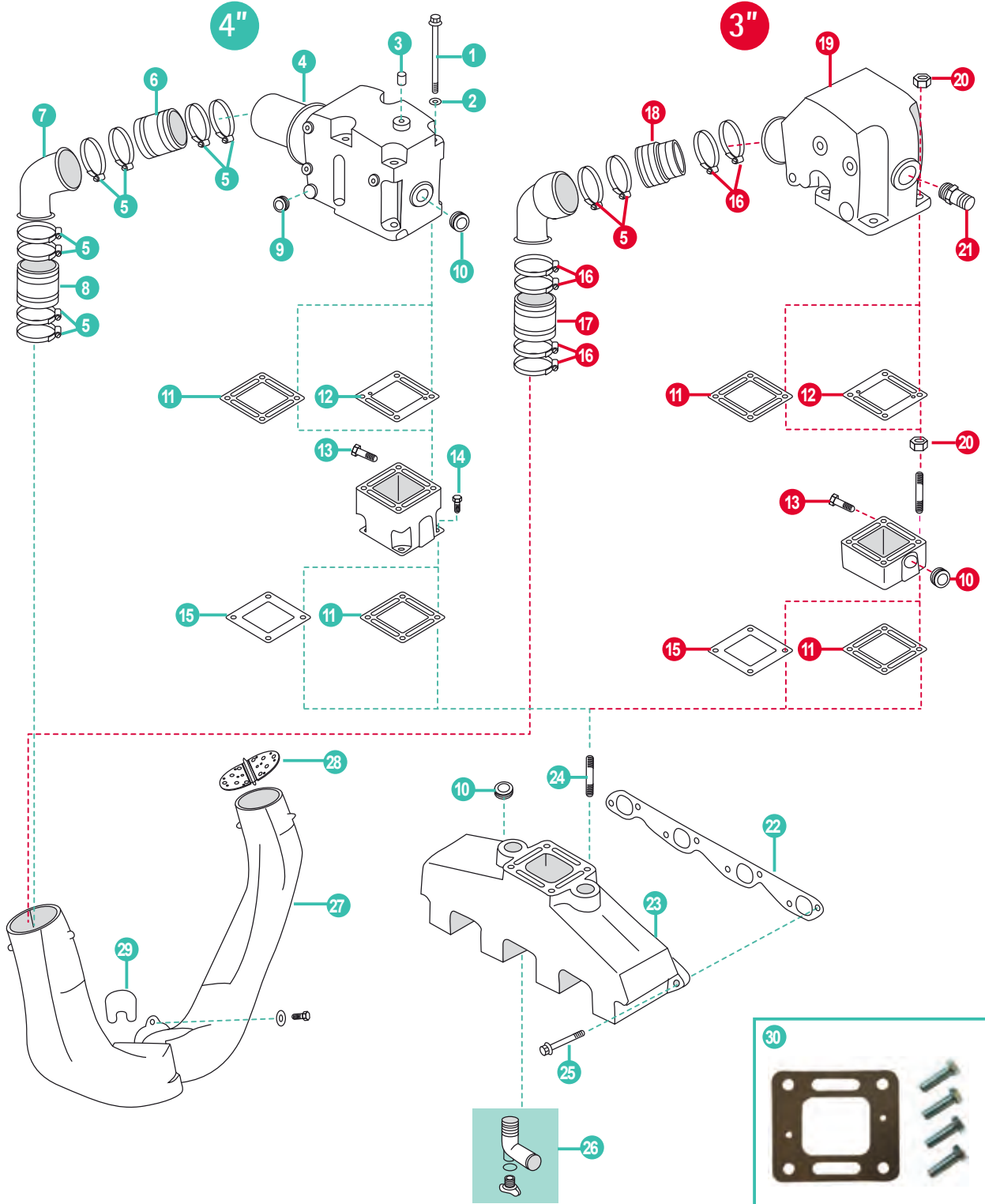

	REF	OEM					UN.
1	REC10-43749	10-43749	TORNILLO	SCREW STEEL ZINC PLATED	VITE	VIS	4
2	REC13-35048	13-35048	CIERRE	LOCKWASHER	CHIUSURA	RONDELLE	4
3	REC22-73379	22-73379	TAPÓN	PLUG	TAPPO	BOUCHON	1
4	MAR988	807988A03	CODO HIERRO 4" 7°	EXHAUST ELBOW (IRON CASTING) 4", 7°	GOMITO IN GHISA 4" 7°	COUDE FE 4" 7°	1
	SED3092600	807988A03	CODO INOX 4" 7°	EXHAUST ELBOW INOX, 4", 7°	GOMITO INOX 4" 7°	COUDE INOX 4" 7°	1
5	GS38322	54-815504372	ABRAZADERA	CLAMP	FASCETTA	COLLIER	10
6	REC32-44348001	32-44348001	FUELLE ESCAPE 4"	EXHAUST BELLOW 4"	CUFFIA SCARICO 4"	SOUFFLET ÉCHAPPEMENT 4"	1
7	BAMC-20-14478	14478T01	TUBO	TUBE	TUBO	TUYAU	1
8	REC32-14358001	32-14358001	FUELLE ESCAPE 4"	EXHAUST BELLOW 4"	CUFFIA SCARICO 4"	SOUFFLET ÉCHAPPEMENT 4"	1
9	REC22-36382	22-36382	TAPÓN	PLUG	TAPPO	BOUCHON	2
	REC22-41622	22-41622	TAPÓN ACERO	PLUG (STEEL)	TAPPO ACCIAIO	BOUCHON ACIER	2
10	REC22-428611	22-428611	TAPÓN BRONCE	PLUG (BRASS)	TAPPO IN BRONZO	BOUCHON BRONZE	2
11	REC27-863726	27-863726	JUNTA	GASKET EXHAUST MANIFOLD AND SPACERS	GUARNIZIONE	JOINT	1
12	REC27-863724Q	27-863724Q	JUNTA CODO ESCAPE	EXHAUST ELBOW GASKET	GUARNIZIONE GOMITO SCARICO	JOINT COUDE ÉCHAPPEMENT	1
13	REC22-328022	22-328022	TAPÓN	PLUG	TAPPO	BOUCHON	2
14	REC10-865982005	10-865982005	TORNILLO	SCREW	VITE	VIS	4
15	REC27-8637251	27-8637251	JUNTA COLECTOR CIRCUITO AGUA DULCE	MANIFOLD FRESH WATER COOLING	GUARNIZIONE COLLETTORE CIRCUITO CHIUSO	JOINT COLLECTEUR EAU FRAÎCHE	1
16	GS38320	54-815504256	ABRAZADERA	CLAMP	FASCETTA	COLLIER	6
17	REC32-90949T	32-90949T	FUELLE ESCAPE 3"	EXHAUST BELLOW 3"	CUFFIA SCARICO 3"	SOUFFLET ÉCHAPPEMENT 3"	1
18	REC70981A3	70981A3	FUELLE ESCAPE 3"	EXHAUST BELLOW 3"	CUFFIA SCARICO 3"	SOUFFLET ÉCHAPPEMENT 3"	1
19	REC98504A3	98504A3	CODO HIERRO 3" 15°	EXHAUST ELBOW (IRON CASTING) 3", 15°	GOMITO IN GHISA 3" 15°	COUDE FE 3" 15°	1
20	REC46335	46335	TUERCA	FLANGE SERRATED NUT	DADO	ÉCROU	4
21	REC22-866725	22-866725	RACORD COLECTOR	STRAIGHT FITTING	RACCORDO COLLETTORE	RACCORD COLLECTEUR	2
22	REC27-46820	27-46820	JUNTA COLECTOR	GASKET EXHAUST MANIFOLD	GUARNIZIONE COLLETTORE	JOINT COLLECTEUR	2
23	MAR078	807078T10	COLECTOR HIERRO	EXHAUST MANIFOLD ASSEMBLY (IRON)	COLLETTORE IN GHISA	COLLECTEUR FE	2
24	REC16-49545	16-49545	ESPÁRRAGO 3/8" x 13/4"	STUD 3/8" x 13/4"	PRIGIONIERO 3/8" x 13/4"	GOUJON 3/8" X 1/4"	4
25	REC10-37612	10-37612	TORNILLO	SCREW	VITE	VIS	8
26	REC862210A01	22-862210A01	KIT TAPÓN Y CONDUCTO	HOSE FITTING WITH DRAIN PLUG KIT	KIT RUBINETTO	COUDE DRAIN POUR COLLECTEUR	1
27	RM807130A4	807130A4	CUERNOS DE ESCAPE	EXHAUST PIPE	CORNA DI SCARICO	CORNE D'ÉCHAPPEMENT	1
28	REC807166A1	807166A1	PALOMILLA DE ESCAPE	WATER SHUTTER	FARFALLA SCARICO	CLAPET ÉCHAPPEMENT	2
29	REC41802	41802	RETÉN TRANSOM	TRANSOM GASKET	GUARNIZIONE TRANSOM	JOINT TRANSOM	1
30	HOT28503-MK		KIT MONTAJE PARA HOT20970	MOUNTING KIT HOT20970	KIT DI MONTAGGIO PER HOT20970	KIT DE MONTAGE POUR HOT20970	
31	RECK8503		KIT TORNILLOS CODO Y JUNTA	EXHAUST ELBOW MOUNTAING KIT	KIT VITI GOMITO	KIT VISSERIE POUR COUDE	
32	REC53400		KIT TORNILLOS CODO Y JUNTA	EXHAUST ELBOW MOUNTAING KIT	KIT VITI GOMITO	KIT VISSERIE POUR COUDE	
33	HOT20976-MK		KIT MONTAJE PARA MAR988	MOUNTING KIT MAR988	KIT DI MONTAGGIO PER MAR988	KIT DE MONTAGE POUR MAR988	
34	REC33765		KIT TORNILLOS COLECTOR Y JUNTA	EXHAUST MANIFOLD MOUNTING KIT	KIT VITI COLLETTORE	KIT VISSERIE POUR COLLECTEUR	
35	HOT20985	93322A12AV	KIT RISER 152 mm	KIT RISER 6"	KIT RISER 6"	KIT HAUSSEUR 6"	
36	MAR3320PAR	93320A13	KIT RISER 76 mm	KIT RISER 3"	KIT RISER 3"	KIT HAUSSEUR 3"	
37	HOT20957-MK		KIT MONTAJE MAR078	MOUNTING KIT ELBOW MAR078	KIT DI MONTAGGIO GOMITO MAR078	KIT DE MONTAGE POUR MAR078	

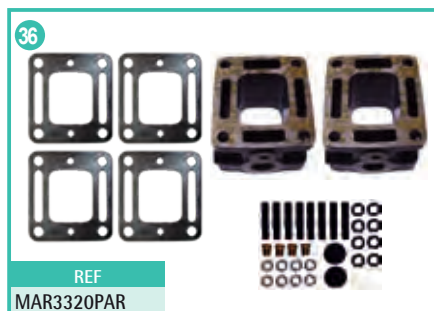

325-325MIE, GM427 CID V8
 330-330MIE 370TRS - 400TRS - 440TRS - GM454 CID
 390 - 390MIE - 460TRS, GM472 CID V8
 225 - 225MIE - 250 - 250MIE - GM327CID - 228 - 228MIE
 GM305CID - 250 - 270 - 270MIE - 280TRS - GM350 CID V8

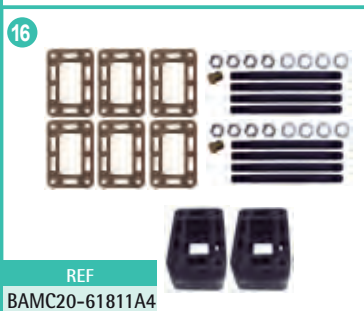
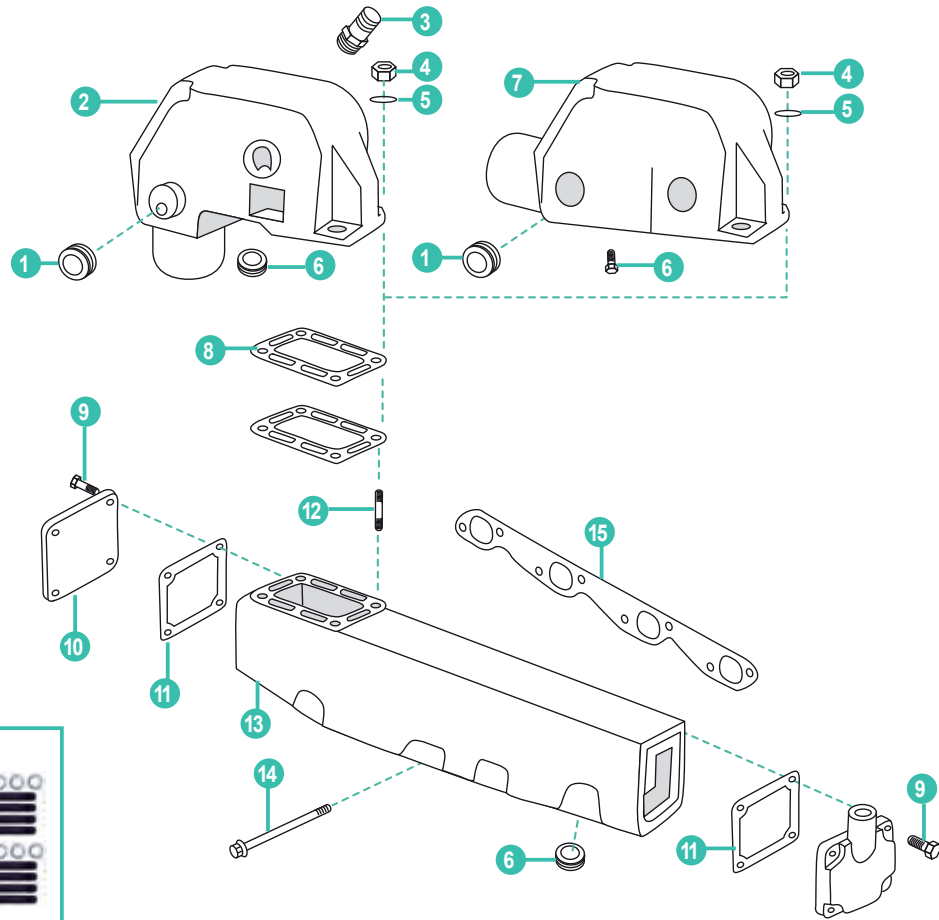

REF
BAMC20-61811A4

	REF	OEM				
1	REC22-41622	22-41622	TAPÓN CODO	ELBOW PLUG	TAPPO SCARICO	BOUCHON COUDE
2	BAMC20-76668	76668A3	CODO ESCAPE	EXHAUST ELBOW	GOMITO SCARICO	COUDE ÉCHAPPEMENT
3	REC22-866725	22-866725	RACORD COLECTOR	STRAIGHT FITTING	TAPPO COLLETTORE	RACCORD COLLECTEUR
4	REC46335	11-46335	TUERCA CODO	NUT	DADO	ÉCROU
5	REC13-35048	13-35048	ARANDELA	WASHER	GUARNAIZIONE	RONDELLE
6	REC22-328022	22-328022	TAPÓN	CAP	TAPPO	BOUCHON
7	BAMC20-72963	72963A9	CODO ESCAPE	EXHAUST ELBOW	GOMITO SCARICO	COUDE ÉCHAPPEMENT
8	REC27-48042	27-48042	JUNTA	GASKET	GUARNIZIONE	JOINT
9	REC10-35386	10-35386	TORNILLO TAPA COLECTOR	SCREW MANIFOLD COVER	VITE COPERCHIO COLLETTORE	VIS COUVERCLE COLLECTEUR
10	HGE4870	73813A1	TAPA COLECTOR	MANIFOLD COVER	COPERCHIO COLLETTORE	COUVERCLE COLLECTEUR
11	REC27-480431	27-480431	JUNTA	GASKET	GUARNIZIONE	JOINT
12	REC16-49545	16-49545	TORNILLO CODO COLECTOR	STUD MANIFOLD	VITE GOMITO COLLETTORE	VIS COLLECTEUR
	BAMC1-47735	47735A17	COLECTOR BABOR	PORT MANIFOLD	COLLETTORE DI SINISTRA	COLLECTEUR BABORD
	BAMC1-47736	47736A17	COLECTOR ESTRIBORD	STBD MANIFOLD	COLLETTORE DI DESTRA	COLLECTEUR TRIBORD
13	BAMC1-47737	47737A1	(225 - 228 - 250 - 270 - 280 - 305 - 327 - 350) COLECTOR BABOR	(225 - 228 - 250 - 270 - 280 - 305 - 327 - 350) PORT MANIFOLD	(225 - 228 - 250 - 270 - 280 - 305 - 327 - 350) COLLETTORE DI SINISTRA	(225 - 228 - 250 - 270 - 280 - 305 - 327 - 350) COLLECTEUR BABORD
	BAMC1-47738	47738A1	(225 - 228 - 250 - 270 - 280 - 305 - 327 - 350) COLECTOR ESTRIBORD	(225 - 228 - 250 - 270 - 280 - 305 - 327 - 350) STBD MANIFOLD	(225 - 228 - 250 - 270 - 280 - 305 - 327 - 350) COLLETTORE DI DESTRA	(225 - 228 - 250 - 270 - 280 - 305 - 327 - 350) COLLECTEUR TRIBORD
14	REC10-37612	10-37612	TORNILLO 11/4"	SCREW 11/4"	VITE 11/4"	VIS 11/4"
	REC27-46820	27-46820	KIT JUNTAS COLECTOR	GASKET EXHAUST MANIFOLD	KIT GUARNIZIONI COLLETTORE	KIT JOINTS COLLECTEUR
15	REC27-33395	27-33395	KIT JUNTAS COLECTOR	GASKET EXHAUST MANIFOLD	KIT GUARNIZIONI COLLETTORE	KIT JOINTS COLLECTEUR
			(225 - 228 - 250 - 270 - 280 - 305 - 327 - 350) KIT SUPLEMENTO CODO	(225 - 228 - 250 - 270 - 280 - 305 - 327 - 350) KIT RISER ELBOW 3"	(225 - 228 - 250 - 270 - 280 - 305 - 327 - 350) KIT SUPPLEMENTO GOMITO 3"	(225 - 228 - 250 - 270 - 280 - 305 - 327 - 350) KIT REHAUSSE 3"
16	BAMC20-61811A4		76 mm			

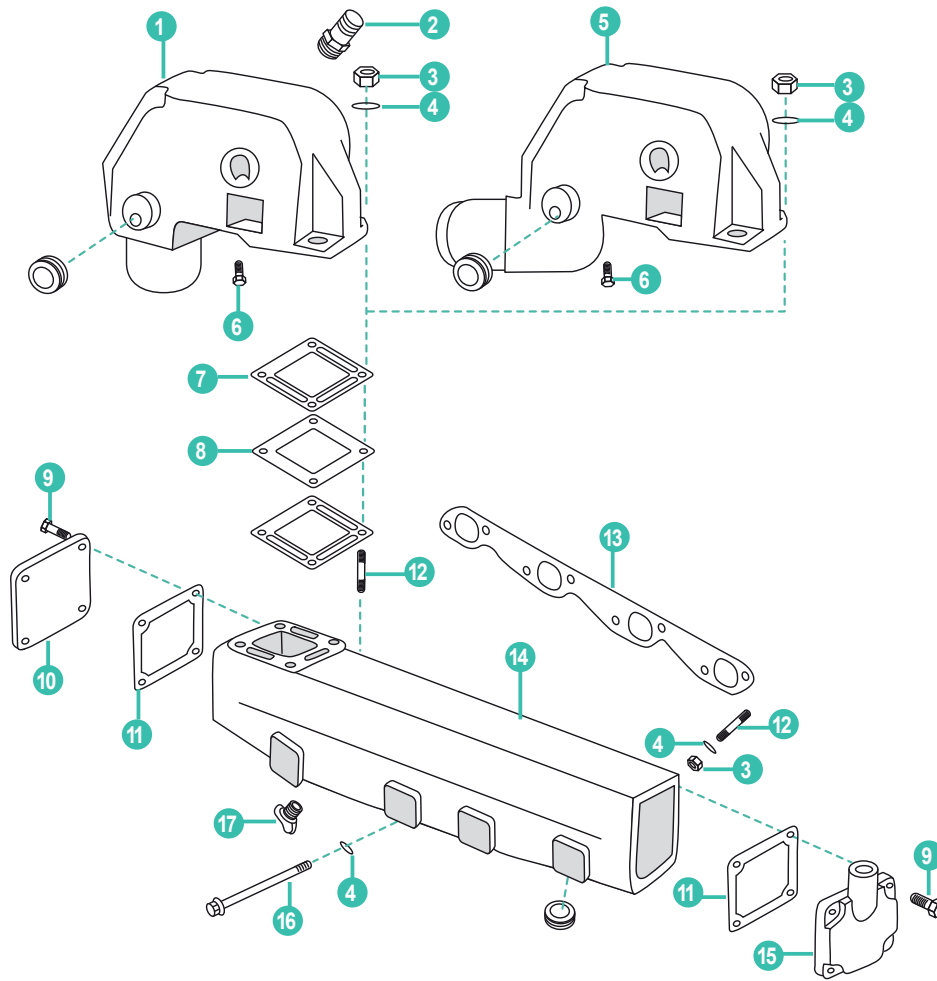

	REF	OEM				
1	HOT20971 HGE6351	76351A04	CODO ESCAPE	EXHAUST ELBOW	GOMITO DI SCARICO	COUDE D'ÉCHAPPEMENT
2	REC22-866725	27-866725	RACORD COLECTOR	STRAIGHT FITTING	RACCORD COLLETTORE	RACCORD COLLECTEUR
3	REC46335	11-46335	TUERCA CODO	NUT	DADO GOMITO	ÉCROU COUDE
4	REC13-35048	13-35048	ARANDELA	WASHER	RONDELLA	RONDELLE
5	HOT20978	76771A2	CODO ESCAPE	EXHAUST ELBOW	GOMITO DI SCARICO	COUDE D'ÉCHAPPEMENT
6	REC22-328022	22-328022	TAPÓN	CAP	TAPPO	BOUCHON
7	REC27-99777Q02	27-99777Q02	JUNTA	GASKET	GUARNIZIONE	JOINT
8	REC60207	60207	TAPA COLECTOR	MANIFOLD COVER	COPERCHIO COLLETTORE	COUVERCLE COLLECTEUR
9	REC10-35386	10-35386	TORNILLO TAPA COLECTOR	SCREW MANIFOLD COVER	VITE COPERCHIO COLLETTORE	VIS COUVERCLE COLLECTEUR
10	HGE4870	73813A1	TAPA COLECTOR	MANIFOLD COVER	COPERCHIO COLLETTORE	COUVERCLE COLLECTEUR
11	REC27-480431	27-40431	JUNTA	GASKET	GUARNIZIONE	JOINT
12	REC16-49545	16-49545	TORNILLO CODO COLECTOR	STUD MANIFOLD	VITE GOMITO COLLETTORE	VIS COUDE COLLECTEUR
13	REC3852455	27-73866	JUNTA COLECTOR ESCAPE	MANIFOLD GASKET	GUARNIZIONE COLLETTORE SCARICO	JOINT COLLECTEUR ÉCHAPPEMENT
14	HOT20962	65603A12	COLECTOR ESTRIBOR	STBD MANIFOLD	COLLETTORE DI DESTRA	COLLECTEUR TRIBORD
	HOT20958	65604A12	COLECTOR BABOR	PORT MANIFOLD	COLLETTORE DI SINISTRA	COLLECTEUR BABORD
15	REC60252A2	60252A2	TAPA COLECTOR	END CAP ASSY	COPERCHIO COLLETTORE	COUVERCLE COLLECTEUR
16	REC10-37612	10-37612	TORNILLO 11/4"	SCREW 11/4"	VITE 11/4"	VIS 11/4"
17	REC22-866725	27-866725	RACORD COLECTOR	STRAIGHT FITTING	RACCORD COLLETTORE	RACCORD COLLECTEUR
18	BAMC20-61851A3	KIT SUPLEMENTO 76 mm	KIT RISER ELBOW 3"	KIT RISER ELBOW 3"	KIT SUPPLEMENTO GOMITO 3"	KIT REHAUSSE 3"
19	HOT20560-MK	KIT MONTAJE PARA HOT20962/58	MOUNTING KIT ELBOW HOT20962/58	MOUNTING KIT ELBOW HOT20962/58	KIT MONTAGGIO GOMITO HOT20962/58	KIT DE MONTAGE POUR HOT20962/58
20	HOT26371-MK	KIT MONTAJE PARA HOT20978/71	MOUNTING KIT ELBOW HOT20978/71	MOUNTING KIT ELBOW HOT20978/71	KIT MONTAGGIO GOMITO HOT20978/71	KIT DE MONTAGE POUR HOT20978/71

COLECTORES

MANIFOLDS

COLLETTORE

COLLECTEURS

REF	OEM	
BAMC-1-63122	63122A10 63122A13 63122A14	120HP GM153

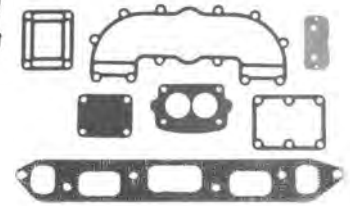

REF	OEM	
HOT20937	98562A6	3.7L & 3.7LX 470, 485, 488 (1980-85) 160, 170, 180, 190 3.7L & 3.7LX (1985-89)



HOT20937-MK



REF	OEM	
BAMC-1-95862	95862A5	Se adapta a la mayoría de: Fits most models Si adatta alla maggior parte dei Convient à la plupart des : 2.5L 153 CID 3.0L 181 CID carb. Rochester (1983-89)



REF	OEM	
REC96705A1	96705A1	Se adapta a la mayoría de: Fits most models Si adatta alla maggior parte dei Convient à la plupart des : 3.0L 181 CID carb. Rochester 2.5L, 153 CID (1968-82)



REF	OEM	
HOT20956	99798A18 806867A8 806235A04	Se adapta a la mayoría de: Fits most models Si adatta alla maggior parte dei Convient à la plupart des : 2.5L 153 CID 3.0L 181 CID carb. Mercab & Electric Chore (1983-95)



HOT20956-MK

REF	OEM	
REC860235A03	860235A03	GM 181 (1990+)
	806867A3	3.0L OM680000+
	806867A12	3.0LX & 3.0TKS PLUS



REF	OEM	
BAMC-1-58759	58759A1	GM160 & GM165 (6 CYL)
	58759A10	
	58759A13	
	58759A14	



REF	OEM	
MAR746	99746A8	GM 4.3L & 3.8L V6 175, 185, 205, 229 & 262 (1985-02)
	99746A17	
	99746A3	





kit HOT20952



kit MAR746



REF	OEM	
MAR612	864612T01	GM4.3L MPI OM615000+ (2002+) 262

REF	OEM	
MAR735	865735A02	50L, 5.7L, 6.2L (V8) 305, 350, 377 (2002+)
	864308T01	
	865049T01	



kit MAR735





REF	OEM	
MAR246	860246A15	305, 350 Et 377 V8GM (1983-02)
	87114A19	
	860246A3	
	860246A9	
	860246A10	









REF	OEM	
MAR078	807078T10	GM V8 BIG BLOCK 330, 340, 370 (454) 7.4L 502 8.2L
	807078T09	
	807078A6	
	89011A8	



BABOR PORT SINISTRA BABORD	ESTRIBOR STD DESTRA TRIBORD		
REF	OEM	REF	OEM
HOT20950	77234A7	77235A8 77235A2	198, 228, 250, 255, 260, 898, 305CID (GM V8) Bloque pequeño con suplemento Small blocks with end riser Blocco piccolo con supplemento Bloque petit avec supplement
	77234A2		



BABOR PORT SINISTRA BABORD	ESTRIBOR STD DESTRA TRIBORD		
REF	OEM	REF	OEM
BAMC1-47735	47735A17	BAMC1-47736	47736A17 47736
	47735		
	47735A1		

BABOR PORT SINISTRA BABORD	ESTRIBOR STD DESTRA TRIBORD		
REF	OEM	REF	OEM
BAMC1-47737	47737A10	BAMC1-47738	47738A10 47738A1
	47737A1		

BABOR PORT SINISTRA BABORD	ESTRIBOR STD DESTRA TRIBORD		
REF	OEM	REF	OEM
HOT20958	65604A4	HOT20962	65603A3 65603A12
	65604A12		

CODOS ELBOW GOMITI COUDE

CODO ELBOW GOMITO COUDE

REF	OEM	
REC76325A2	76325A2	GM 2.5L & 3.0L (1982-89) OLD MODEL (6 CYL INLINE)



REF	OEM	
MAR309	864309T02 864309T01	GM V6 & V8 262, 305, 350, 377, 383 MPI (2002+) 7° (4" O.D. RISER)



**CODO BAJO
LOW ELBOW
GOMITO BASSO
COUDE BASSE**

REF	OEM	
BAMC-20-55538	55538A2 39920	120 GM 153 (4 CYL) (1964-82) 160 GM 250 (6 CYL INLINE) (1967-69)

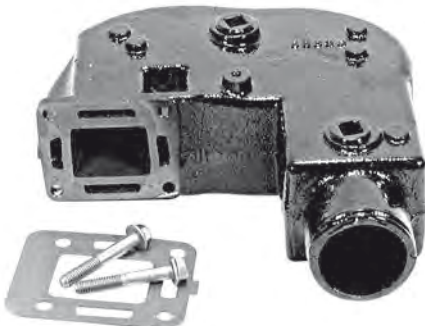

REF	OEM	
MAR591	864591T02	GM V6 & V8 262, 305, 350, 377, 385, 6.2L MPI (2002+) 7° (4" O.D. RISER)



**CODO ALTO
HIGH ELBOW
GOMITO ALTO
COUDE HAUTE**

REF	OEM	
MAR076	12076A2	GM 2.5L, 3.0 & 3.0LX (1982+) NEW MODEL



REF	OEM	
BAMC20-76668	76668A3 76668A1 72964A1 47877A4	GM (454, 350, 305, 330 V8) 228, 250, 280, 288 Aplic: 3" O.D. RISER





REF	OEM	
MAR988	807988A03 807988A2 807914A1 44354A3	GM V6 & V8 SMALL & BIG BLOCK (1983-02) 7° (4" O.D. RISER)



REF	OEM	
REC76771A2	76771A2 76771A3	V8 GM & FORD 470 (224/L4) GM (6 CYL INLINE) (-1983)





REF	OEM	
REC98504A3	98504A3	GM V6 Et V8 SMALL Et BIG BLOCK (1983+) 15° (3" O.D. RISER)



REF	OEM	
HOT20971	76351A04 76351A2 60426A1	MCM: 140, 470, 165 Et 200 (6 CYL INLINE) GM V8 305,350 FORD V8 302, 351 (-1982)



REF	OEM	
BAMC20-72963	72963A9 72963A1 76788A1 48101A1	GM V8 (454, 427, 482, 327, 350) 225, 250, 270, 325, 390, 330, 350, 370, 400, 440, 460 (1967-86) 3" O.D. RISER



CODO ESCAPE PARA COLECTOR AL

EXHAUST ELBOW FOR MANIFOLD AL

GOMITO DI SCARICO PER COLLETTORE AL

COUDE ÉCHAPPEMENT POUR COLLECTEUR AL

REF	OEM	
HOT20937	98562A6	165, 140, 180, 190 3.7L Et 3.7 LX (1985-89)



CODO ESCAPE PARA COLECTOR HIERRO

EXHAUST ELBOW FOR MANIFOLD. IRON

GOMITO DI SCARICO PER COLLETTORE. GHISA

COUDE ÉCHAPPEMENT POUR COLLECTEUR FE

REF	OEM	
HOT20905	90880A2	165, 170, 180, 190 3.7L Et 3.7 LX MCM (1980-89)





**CODO ESCAPE
INOX 316**

316 SS EXHAUST ELBOW

REF	OEM	
SED3093300	805602A2	530DTA, 636, D183, D2.8L, D219, D254, D3.0L, D3.6L, D4.2L



**GOMITO DI SCARICO
INOX 316**

**COUDE ÉCHAPPEMENT
INOX 316**

REF	OEM	
SED3092000	805602A1	2.8L, D254, D3.6L, D4.2L



REF	OEM	
SED3093301	80176320	D183T, D219T, D530TA



**CODO ESCAPE
INOX 316**

316 SS EXHAUST ELBOW

REF	OEM	
SED3092610	12076A2	4 CYL LATE MODELS



**GOMITO DI SCARICO
INOX 316**

COUDE ÉCHAPPEMENT

REF	OEM	
SED3092600	807988A03	V6 & V-8 7" (4" O.D. RISER)



REF	OEM	
SED3095400	864309T02	GM V6 & V8 262, 305, 350, 377, 383 MPI (2002+) 4" O.D. RISER

**CODO BAJO
LOW ELBOW
GOMITO BASSO
COUDE BASSE**



REF	OEM	
SED3095500	864591T02	GM V6 & V8 262, 305, 350, 377, 385, 6.2L MPI (2002+) 4" O.D. RISER

**CODO ALTO
HIGH ELBOW
GOMITO ALTO
COUDE HAUTE**





KIT RISER 3" / 76mm

REF	OEM	COLECTORES MANIFOLDS COLLETTORI COLLECTEURS	
MAR3320PAR	93320A13 807476A6 93320A5	MAR746 MAR246 MAR078 (-2002)	305, 350, 262, 454, 502 (5.0, 5.7, 4.3, 7.4, 8.2) MCM V6 & TBI (2 colectores escape 2 exhaust manifold 2 collettore di scarico 2 collecteurs échappement) (-OM614999) MCM/MIE/SKI V8 (305, 350, 377, 354 & 502 CID) (Codo de hierro cast iron elbow gomito in ghisa coude) (-OM299999) MCM V8 (305 & 350 CID) Carb. (OM300000-OM599999) MIE & SKI Carb. (OM300000-OM316999)

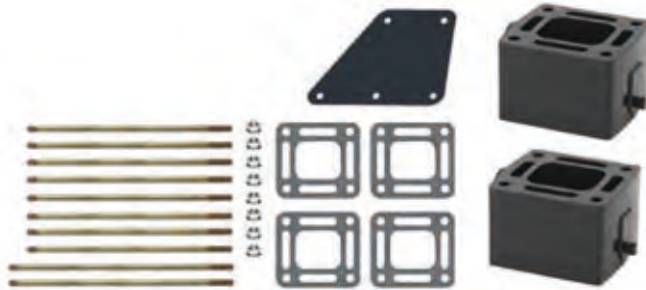

REF	OEM	COLECTORES MANIFOLDS COLLETTORI COLLECTEURS	
REC93320A15	93320A15 93320A10	MAR746 MAR246 MAR078 (-2002)	MCM 4.3L MPI (OM3000000-OM614999) (2001-02) MCM V8 (305, 350, 377 CID) MPI (OM300000-OM599999) (2001-02) MIE & SKI V8 (350 & 377 CID) MPI (OM300000-OM316999) (2001-02) (sólo codos de hierro Only with cast iron elbows Solo gomiti in ghisa seulement coudes en Fe)



REF	OEM	COLECTORES MANIFOLDS COLLETTORI COLLECTEURS	
MAR929 HGE4929	864929A3	MAR612	350, 357, 377, 383, 385 (MAG, MPI) GM V6&V8 (4.3, 5.0, 5.7, 6.2) (2002+)



REF	OEM	COLECTORES MANIFOLDS COLLETTORI COLLECTEURS	
BAMC20-61811A4	61811A4 61811A3	BAMC1-47736 BAMC1-47737 BAMC1-47738 BAMC1-47735	GM V8 (427, 454 & 582 CID) 327, 305, 350 225, 250, 255, 270 & 280 (1977+) BASE RECTANGULAR RECTANGULAR BASE BASE RETTANGOLARE BASE RECTANGULAIRE

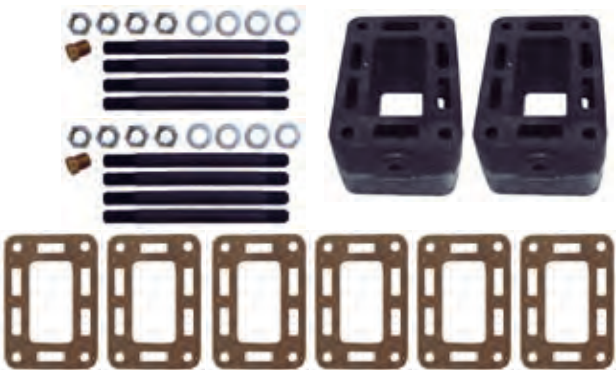

REF	OEM	COLECTORES MANIFOLDS COLLETTORI COLLECTEURS	
BAMC20-61851A3	61851A3	REC96705A1 HOT20956 BAMC-1-58759	140 HP (181 4cyl), 120 (2.5L), 153 GM 160, 165 (6 cyl inline)

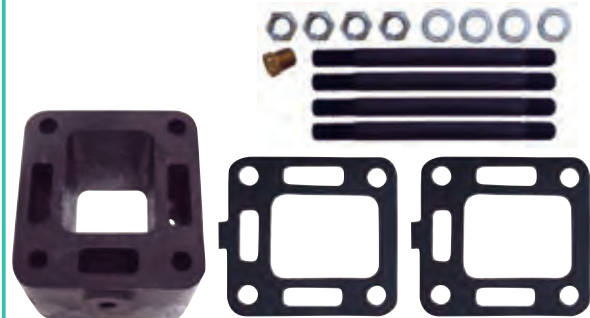

KIT RISER 6" / 152mm

REF	OEM	COLECTORES MANIFOLDS COLLETTORI COLLECTEURS	
HOT20985	93322A12	MAR746 MAR246 MAR078 (-2002)	MCM V6 & TBI (2 colectores 2 manifold 2 collettore 2 collecteurs) (-OM614999) MCM/MIE/SKI V8 (305, 350, 377, 354 & 502 CID) (Fe) (-OM299999) MCM V8 (305 & 350 CID) Carb. (OM300000-0M599999) MIE & SKI Carb. (OM300000-0M316999)



REF	OEM	COLECTORES MANIFOLDS COLLETTORI COLLECTEURS	
BAMC-20-864908A1	864908A1	MAR612	350, 357, 377, 383, 385 (MAG, MPI) GM V6&V8 (4.3, 5.0, 5.7, 6.2) (2002+)

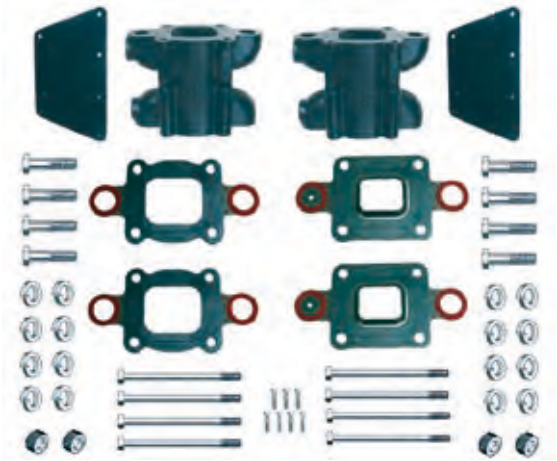

TAPONES

CAPS

TAPPI

BOUCHONS

REF	ROSCA
REC22-428611	3/4 - 14NPT
REC22-328022	1/8 - 27 NPT
REC22-32803	3/8 - 18 NPT
REC22-36382	1/4 - 18 NPT
REC22-41622	3/4 - 14 NPT
REC13980	
REC22-73379	.250-18



EXTENSORES DE ESCAPE

EXHAUST EXTENSIONS

ESTENSIONI DI SCARICO

PROLONGATEURS D'ÉCHAPPEMENT

REF	OEM	Ø	
BAMC-20-14478	14478T01 14478T	4"	175, 205, 229, 262 (V6) (1983-05) 200, 320, 305, 350, 377 (V8) (1993+) 330, 370, 454, 502 (V8 BIG BLOCK) (1981+)



REF	OEM	
RM14801A1	14801A1	5.0, 5.7, 6.2L V8 (1998+) INSTALLAR EN MODELOS CON KITS DE RISER DE 3" & 6" INSTALL IN MODELS WITH 3" & 6" RISER KITS INSTALLARE NEI KIT DEI RISER DA 3" e 6" À INSTALLER SUR LES MODÈLES AVEC KITS DE 3" ET 6".



REF	OEM	
807130A4	"Y" PIPE V6 & V8, Alpha, Bravo	
RM807130A4	8M0115149 4.3, 5.0, 5.7, 6.2, 7.4, 8.2L GM	
44266T	4.5L MPI	
44266T1	7° 4" Codos Elbows Gomiti Coudes	



TAPAS Y JUNTAS

CAPS & GASKETS

COPERCHI E GUARNIZIONE

COUVERCLES ET JOINTS

TAPA DE COLECTOR

END CAP MANIFOLD

COPERCHIO COLLETTORE

COUVERCLE COLLECTEUR

REF	OEM	COLECTORES MANIFOLDS COLLETTORI COLLECTEURS	
BA1-47638	47638A1	BAMC-1-63122	

REF	OEM	COLECTORES MANIFOLDS COLLETTORI COLLECTEURS	
REC60252A2	60252A2	REC96705A1 BAMC-1-58759 HOT20950 BAMC1-47735 BAMC1-47736 BAMC1-47737 BAMC1-47738 HOT20962 HOT20958	

REF	OEM	COLECTORES MANIFOLDS COLLETTORI COLLECTEURS	
HGE4870	73813A1	BAMC1-47735 BAMC1-47736 BAMC1-47737 BAMC1-47738 REC96705A1 BAMC-1-95862 HOT20956 BAMC-1-58759	

REF	OEM	COLECTORES MANIFOLDS COLLETTORI COLLECTEURS	
REC805629A1	805629A1	BAMC-1-95862 HOT20956	

JUNTAS TAPAS LATERALES SIDE GASKET CAPS

GUARNIZIONE COPERCHIO LATERALE

JOINTS COUVERCLE LATERAL

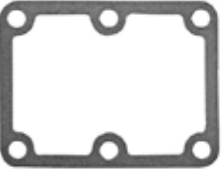
REF	OEM	TAPAS CAPS COPERCHIO COUVERCLE	
REC27-39917	27-39917	BA1-47638	

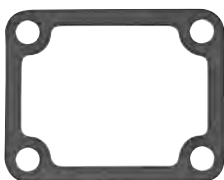
REF	OEM	TAPAS CAPS COPERCHIO COUVERCLE	
BAMC47-27-39923	27-39923	39916	

REF	OEM	TAPAS CAPS COPERCHIO COUVERCLE	
REC27-807218	27-807218	HGE4870 REC805629A1	

REF	OEM	TAPAS CAPS COPERCHIO COUVERCLE	
REC27-480431	27-480431	REC60252A2	

**JUNTAS TAPA POSTERIOR
INTERCAMBIADOR**

**HEAT EXCHANGER END
CAP**

**COPERCHIO POSTERIORE
SCAMBIATORE**

**JOINTS DU COUVERCLE
ARRIERE DE L'ECHANGEUR**

REF	OEM	
REC27-99960	27-99960	224 CID (1976-89)



JUNTAS COLECTOR-CODO

**MANIFOLD-ELBOW
GASKET**

**GUARNIZIONE
COLLETTORE-GOMITO**

**JOINTS
COLLECTEUR - COUDE**

REF	OEM	CODOS ELBOWS GOMITI COUDES
REC27-39915	27-39915	BAMC-20-55538

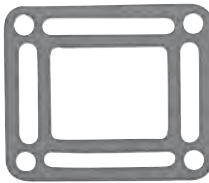

REF	OEM	CODOS ELBOWS GOMITI COUDES
REC27-99777Q02	27-99777Q02	HOT20971
	27-997771	REC76771A2
	27-997772	MAR076
		REC76325A2



REF	OEM	CODOS ELBOWS GOMITI COUDES
REC27-18272	27-18272	HOT20937 AL



REF	OEM	CODOS ELBOWS GOMITI COUDES
REC27-856705	27-856705	HOT20905
	27-97542	FE



REF	OEM	CODOS ELBOWS GOMITI COUDES
REC27-8637251	27-8637251	MAR988
	860231	REC98504A3
	863725	



REF	OEM	CODOS ELBOWS GOMITI COUDES
REC27-48042	27-48042	BAMC20-76668
		BAMC20-72963



REF	OEM	CODOS ELBOWS GOMITI COUDES
REC27-863724Q	27-863724Q	MAR988
	27-41813	REC98504A3
	27-860233	
	27-863724	



REF	OEM	CODOS ELBOWS GOMITI COUDES
REC270	27-864547A02	MAR309
	27-864550A02	MAR591
	27-864549A02	



REF	OEM	CODOS ELBOWS GOMITI COUDES
REC27-863726	27-863726	MAR988
	27-871051	REC98504A3
	27-818832	
	27-860232	



REF	OEM	CODOS ELBOWS GOMITI COUDES
REC8M2004414	8M2004414	STANDARD COOLING V6 Et V8 NEW MODELS



new

new

REF	OEM
RM27-864549A02	27-864549A02

1 CLOSED COOLING



new

REF	OEM
REC27-864547A02	27-864547A02

2 OPEN COOLING



new

REF	OEM
REC27-864850A02	27-864850A02

3 RESTRICTOR COOLING

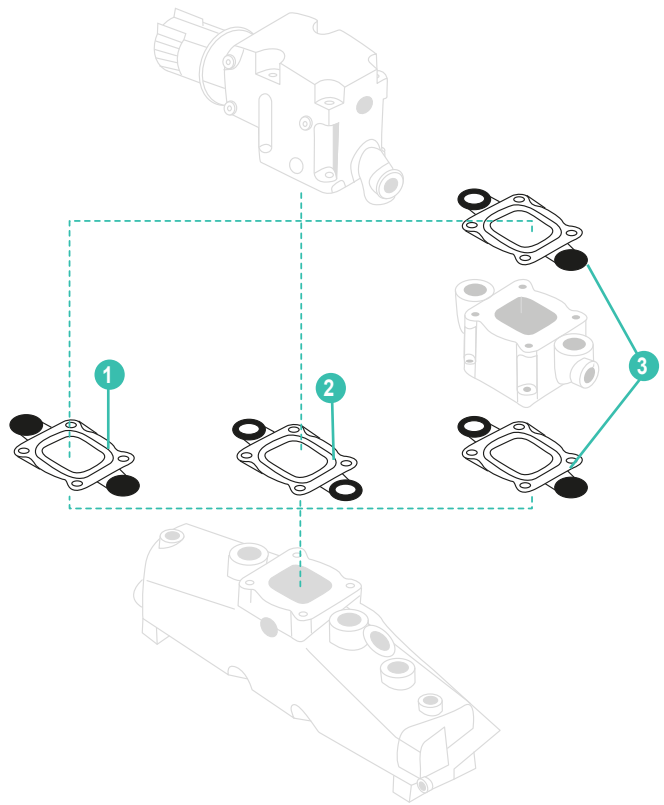
JUNTAS COLECTOR-CULATA **MANIFOLD-HEAD GASKET**

REF	OEM	
REC27-68715	27-68715	MCM 3.7L (4 cyl)



REF	OEM	COLECTORES MANIFOLDS COLLETTORI COLLECTEURS	
REC27-52546	27-52546	BAMC-1-63122	GM 153 (4 cyl)



REF	OEM	COLECTORES MANIFOLDS COLLETTORI COLLECTEURS	
REC27-53354	27-53354	REC96705A1	GM 181 (4 cyl)



GUARNIZIONE COLLETTORE-TESTATA **JOINTS COLLECTEUR-CULASSE**

REF	OEM	COLECTORES MANIFOLDS COLLETTORI COLLECTEURS	
REC27-815528	27-815528	REC860235A03	GM 181 (4 cyl)





REF	OEM	COLECTORES MANIFOLDS COLLETTORI COLLECTEURS	
FEL17319	27-46401	BAMC-1-58759	GM 250 (6 cyl Inline)



REF	OEM	COLECTORES MANIFOLDS COLLETTORI COLLECTEURS		
REC27-99757	27-99757	MAR746 MAR612	GM V6	1



REF	OEM	COLECTORES MANIFOLDS COLLETTORI COLLECTEURS	
REC27-96429	27-96429	BAMC-1-95862 HOT20956	GM 153 & 181 (4 cyl)





REF	OEM	COLECTORES MANIFOLDS COLLETTORI COLLECTEURS		
REC27-33395	27-33395	HOT20950	GM V8 SMALL BLOCK	1
FEL17420		MAR246		2



REF	OEM	COLECTORES MANIFOLDS COLLETTORI COLLECTEURS		
REC27-46820	27-46820	MAR078 BAMC1-47735 BAMC1-47736	GM V8 BIG BLOCK	1



REF	OEM	COLECTORES MANIFOLDS COLLETTORI COLLECTEURS		
REC3852455	27-73866	HOT20958	FORD V8 (302, 351)	1
FEL17460		HOT20962		2



FUELLES DE ESCAPE

EXHAUST BELLOW

REF	OEM	
REC53114A1	53114A1	120, 140, 160, 165 (GM 181 & 250)
CEF500524	53114	(1967-82)



REF	OEM	Ø IN.
REC70981A3	70981A3	3" - 4" (76 - 101 mm)
CEF500523		



REF	OEM	Ø IN.
REC32-90949T	32-90949T	3" (76 mm)
CEF500511K		



CUFFIA DI SCARICO

SOUFFLET D'ÉCHAPPEMENT

REF	OEM	Ø IN.
REC32-44348001	32-44348001	4" (101 mm)
CEF500507K	32-44348T	Tubo superior Upper tubo
	32-44348	Tubo superiore Tube supérieure



REF	OEM	Ø IN.
REC32-14358001	32-14358001	4" (101 mm)
CEF500508K	32-14358T	Tubo inferior Lower tubo
	32-14358	Tubo inferiore Tube inférieure



REF	OEM	Ø IN.	
REC32-807458T	32-807458T	4" (101 mm)	4.3L (1996+)
CEF500532K			



PALOMILLAS DE ESCAPE

WATER SHUTTER

REF	OEM	Ø	
REC99370A2	99370A2	3" (76 mm)	V6-V8 (1982-87)





REF	OEM	Ø	
REC807166A1	807166A1	4" (101 mm)	V6-V8 (1992+) 4.5L MPI



FARFALLA DI SCARICO

CLAPET D'ÉCHAPPEMENT

REF	OEM	Ø		
REC807166A3	807166A3	4" (101 mm)	V6-V8 (1992-95)	2
14348A1			D3.0, D3.6, D4.2L	



REF	OEM	
REC60930	60930	4 cyl 140 / 3.0L / 3.0LX V8 TDI 4.2L (335, 370 MCM/MIE)



PROTECTORES SALIDA DE ESCAPE

EXHAUST PROTECTOR VALVES

PROTEZIONE SCARICO

PROTECTEURS DE SORTIE D'ÉCHAPPEMENT

REF	OEM	
REC34765A2	34765A2	76 mm = 3"
REC12644A1	12644A1	101 mm = 4"
REC89260		127 mm = 5"
		152 mm = 6"



REC34765A2



REC12644A1



REC89260

COLECTOR ADMISIÓN

INTAKE MANIFOLD

COLLETTORE ASPIRAZIONE



COLLECTEURS ADMISSION

TAPA DE COLECTOR



END CAP MANIFOLD

COPERCHIO COLLETTORE



COUVERCLE COLLECTEUR

REF	OEM			
MP425036	824330 824330T	8	GM 262, 4.3 (V6) VORTEC (4 bbl) FE (1993+)	REC824326002





REF	OEM			
MP425113	811575 811575T 59974	16	GM V8 BIG BLOCK 427 & 454 (1969-97) GEN IV, V, VI (4 bbl)	REC17340





REF	OEM			
MP425024	824324T 824324	8	GM 262, 4.3 (V6) VORTEC (2 bbl) FE (1993+)	REC824326002



REF	OEM			
MP425149	72608 72608T	16	GM 454, 482, 502 (1978-97)	REC17341



REF	OEM			
REC425062	807289A1	8	M V8 (350, 5.7) VORTEC (4 bbl) (1993+)	REC27-807473A1



UNIDADES DE TRANSMISIÓN TRANSMISSION UNIT

UNITÀ DI TRASMISSIONE EMBASES ET PIÈCES

BRAVO I, II, III

PARTE SUPERIOR

DRIVE SHAFT HOUSING

PARTE SUPERIORE

PARTIE SUPÉRIEURE

OEM	2	REDUCCIÓN RATIO RIDUZIONE REDUCTION	SERIAL
1589-865440H52	REC1589-865440H52	BRAVO 1 1.65 BRAVO 2 2.20 BRAVO 3 2.20 & 2.43	30/23
1589-865440H51	REC1589-865440H51	BRAVO 1 1.50 BRAVO 2 1.65 & 2.00 BRAVO 3 1.5, 1.65 & 2.00	32/27 0W250000 +
1589-865440H50	REC1589-865440H50	BRAVO 1 1.36 BRAVO 2 1.81 BRAVO 3 1.36 & 1.81	29/27



PARTE INFERIOR

COMPLETE GEAR HOUSING ASSEMBLY

PARTE INFERIORE

PARTIE INFÉRIEURE

OEM	1	REDUCCIÓN RATIO RIDUZIONE REDUCTION	ENTRADAS DE AGUA WATER INTAKE PRESA D'ACQUA INLETS D'EAU	SERIAL
BRAVO I	1656-8866A55 1656-8866A63	REC1656-8866A55 REC1656-8866A63	ALL ALL	1 2
BRAVO III	1656-8M0046733 1656-8M0046735 1656-8M0046738 1656-8M0046682	REC1656-8M0046733 REC1656-8M0046735 REC1656-8M0046738 REC1656-8M0046682	1.36 & 1.5 1.65 1.81, 2.00 & 2.20 2.43	OD784124+ & X OD784124+ & X, XR 0W240000+ 0W240000+ OD784124+ & X



COLA COMPLETA

COMPLETE DRIVE SHAFT

PIEDE COMPLETO

EMBASSE COMPLÉT

OEM	REDUCCIÓN RATIO RIDUZIONE REDUCTION	ENTRADAS DE AGUA WATER INTAKE PRESA D'ACQUA INLETS D'EAU	SERIAL
BRAVO I	5-5231100NP REC1589-865440H50 REC1656-8866A55	1.36	1 0M0100001 - 0W249999
	5-5231200NP REC1589-865440H51 REC1656-8866A55	1.50	1 0M0100001 - 0W249999
	5-5231300NP REC1589-865440H50 REC1656-8866A55	1.65	1 0M0100001 - 0W249999
	5-5231100TP REC1589-865440H50 REC1656-8866A63	1.36	2 0W250000 +
	5-5231200TP REC1589-865440H51 REC1656-8866A63	1.50	2 0W250000 +
	5-5121300TP REC1589-865440H52 REC1656-8866A63	1.65	2 0W250000 +
BRAVO III	5-5441100TP REC1589-865440H50 REC1656-8M0046733	1.36	0W250000 +
	5-5441200TP REC1589-865440H51 REC1656-8M0046733	1.50	0W250000 +
	5-5441300TP REC1589-865440H51 REC1656-8M0046735	1.65	0W250000 +
	5-5441400TP REC1589-865440H50 REC1656-8M0046738	1.81	0W250000 +
	5-5441600TP REC1589-865440H51 REC1656-8M0046738	2.0	0W250000 +
	5-5441500TP REC1589-865440H52 REC1656-8M0046738	2.20	0W250000 +
	5-5441700TP REC1589-865440H52 REC1656-8M0046682	2.43	0W250000 +



R / MR / ALPHA ONE

COLA COMPLETA

COMPLETE DRIVE SHAFT

PIEDE COMPLETO

EMBASE COMPLÉT

STD ROT. (13/21 THEETH 1972-92)		CONTRAROTACIÓN COUNTER ROTATION CONTRO-ROTAZIONE CONTRE-ROTATION		REDUCCIÓN RATIO RIDUZIONE REDUCTION	
OEM	1	OEM	1	2	
5-5010147CP	REC1623-8951A43	5-5000147CP	REC1623-8951A33	REC1547-9412A20	1.47, 1.50 (20/22) V8 (-300HP)
5-5010162CP		5-5000162CP		REC1547-9412A21	1.62, 1.65 (24/24) 6 Cyl in-line
5-5010181CP		5-5000181CP		REC1547-9412A22	1.81, 1.84 (17/19) V6 Et 470/485
5-5010194CP		5-5000194CP		REC1547-9412A23	1.94, 1.98 (20/24) 4 Cyl in-line

Se suministra en dos piezas sin tornillos de unión ni ánodos. Para una instalación completa pida las siguientes referencias:

Supplied in 2 pieces without union screws nor anodes. For a complete installation ask for the following references:

Fornito in due pezzi senza viti di unione e senza anodi. Per un'installazione completa richiedere i seguenti riferimenti:

Livré en deux pièces sans vis de connexion et sans anodes. Pour une installation complète, veuillez demander les références suivantes :

REF					UN.
REC10-30206	TORNILLO	SCREW	VITE	VIS	1
REC11-34933	TUERCA	NUT	DADO	ÉCROU	5
CMALPHAGEN1KITA	KIT ANODOS	ANODES KIT	KIT ANODI	KIT ANODES	1



PARTE SUPERIOR COMPLETA

COMPLETE DRIVE SHAFT HOUSING

PARTE SUPERIORE COMPLETO

PARTIE SUPÉRIEURE COMPLETE

2	OEM	REDUCCIÓN RATIO RIDUZIONE REDUCTION	
REC1547-9412A20	1547-9412A20	1.47, 1.50 (20/22)	V8 (-300 HP) 9-9/16" new style input yoke 6 Cyl inline
REC1547-9412A21	1547-9412A21	1.62, 1.65 (24/24)	9-9/16" new style input yoke V6 Et 470/485
REC1547-9412A22	1547-9412A22	1.81, 1.84 (17/19)	9-9/16" new style input yoke 4 Cyl inline
REC1547-9412A23	1547-9412A23	1.94, 1.98 (20/24)	9-9/16" new style input yoke





MC1 / R / MR / ALPHA ONE

PARTE INFERIOR COMPLETA

COMPLETE GEAR HOUSING ASSEMBLY

PARTE INFERIORE COMPLETA

PARTIE INFÉRIEURE COMPLETE

STD		CR		ESTRÍAS EJE SPLINE DRIVE SHAFT SCALANATURE ASSE SPLINES D'ARBRE	
OEM	1	OEM	1		
1623-8951A43	REC1623-8951A43	1623-8951A33	REC1623-8951A33	13	6225577+ (1972-92)

CARCASA PARTE INFERIOR (Sin componentes)
GEAR HOUSING (Without components)
CARCASSA PARTE INFERIORE (Senza componenti)
BOÎTIER PARTIE INFÉRIEURE (sans les composants)

REF	OEM	
REC1623-5356A4	1623-5356A4	1 Et R
REC1623-8951A37	1623-8951A37	Alpha One Et MR



ALPHA ONE GEN II

COLA COMPLETA

COMPLETE DRIVE SHAFT

PIEDE COMPLETO

EMBASE COMPLET

STD ROT. (13/21 THEETH 1972-92)	CONTRAROTACIÓN COUNTER ROTATION CONTRO-ROTAZIONE CONTRE-ROTATION	REDUCCIÓN RATIO RIDUZIONE RÉDUCTION	
OEM 1	OEM 1	2	
5-5121200TP	5-5111200TP	REC1547-861063A12	1.47 (20/22) 5.0L EFI
5-5121300TP	5-5111300TP	REC1547-861063A10	1.62 (24/24) 5.7 350 MAG (MPI) -300HP
5-5121400TP	5-5111400TP	REC1547-861063A8	1.81 (17/19) 4.3 LH / 4.3L EFI / 5.0L (MPI)
5-5121500TP	5-5111500TP	REC1547-861063A6	1.81 (17/19) 4.3L / 4.3LX (MPI)
			1.94 (20/24) 3.0L / 3.0LX (MPI)

Se suministra en dos piezas sin tornillos de unión ni ánodos. Para una instalación completa pida las siguientes referencias:

Supplied in 2 pieces without union screws nor anodes. For a complete installation ask for the following references:

Fornito in due pezzi senza viti di unione e senza anodi. Per un'installazione completa richiedete i seguenti riferimenti:

Livré en deux pièces sans vis de connexion et sans anodes. Pour une installation complète, veuillez demander les références suivantes :

REF	UN.
REC10-816601 TORNILLO SCREW VITE VIS	4
REC11-859135 TUERCA NUT DADO ÉCROU	4
REC12-45176 ARANDELA WASHER RONDELLA RONDELLE	4
REC23-816583 TUBO AGUA WATER TUBE TUBO ACQUA TUYAU D'EAU	1
CMALPHAKITA KIT ANODOS ANODES KIT KIT ANODI KIT ANODES	1

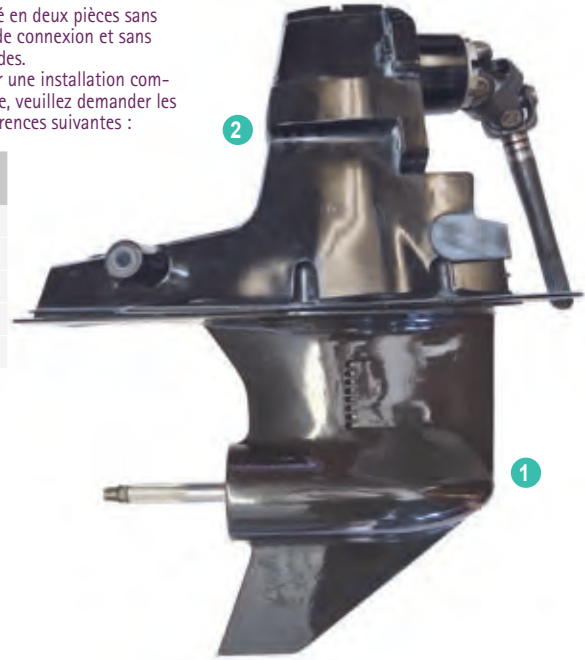

PARTE SUPERIOR COMPLETA

COMPLETE DRIVE SHAFT HOUSING

PARTE SUPERIORE COMPLETO

PARTIE SUPÉRIEURE COMPLETE

2	OEM	REDUCCIÓN RATIO RIDUZIONE RÉDUCTION	
REC1547-861063A12	1547-861063A12	1.47 (20/22)	5.0L EFI / 5.7 / 350 MAG
REC1547-861063A10	1547-861063A10	1.62 (24/24)	4.3LH / 4.3L EFI / 5.0L
REC1547-861063A8	1547-861063A8	1.81 (17/19)	4.3L / 4.3LX
REC1547-861063A6	1547-861063A6	1.94 (20/24)	3.0L / 3.0LX

CARCASA PARTE SUPERIOR (Sin componentes)
DRIVE SHAFT HOUSING (Without components)
CARCASSA PARTE SUPERIORE (Senza componenti)
BOÎTIER PARTIE SUPÉRIEURE (sans les composants)

REF	OEM	
REC1547-815930A7	1547-815930A7	OD469859-OK999999, (1991-97)

PARTE INFERIOR COMPLETA

COMPLETE GEAR HOUSING ASSEMBLY

PARTE INFERIORE COMPLETA

PARTIE INFÉRIEURE COMPLETE

STD	CR	REDUCCIÓN RATIO RIDUZIONE RÉDUCTION	
OEM 1	OEM 1		
1623-815822A53	1623-815822A47	2.00, 2.40	OD469859+
1623-815822A43	REC1623-815822A47	2.00, 2.40 (14/28 dientes teeth denti dents)	OL100040+ (1998+)
1623-815823A5			
1623-815822A32			
1623-815822A45			
623-815822A55			

CARCASA PARTE INFERIOR (Sin componentes)
GEAR HOUSING (Without components)
CARCASSA PARTE INFERIORE (Senza componenti)
BOÎTIER PARTIE INFÉRIEURE (sans les composants)

REF	OEM	
REC1623-815822A30	1623-815822A30 1623-815822A6	OD469859-OK999999 3.50" OD FWD bearing

R / MR / ALPHA ONE
(6225577 - OD469858)

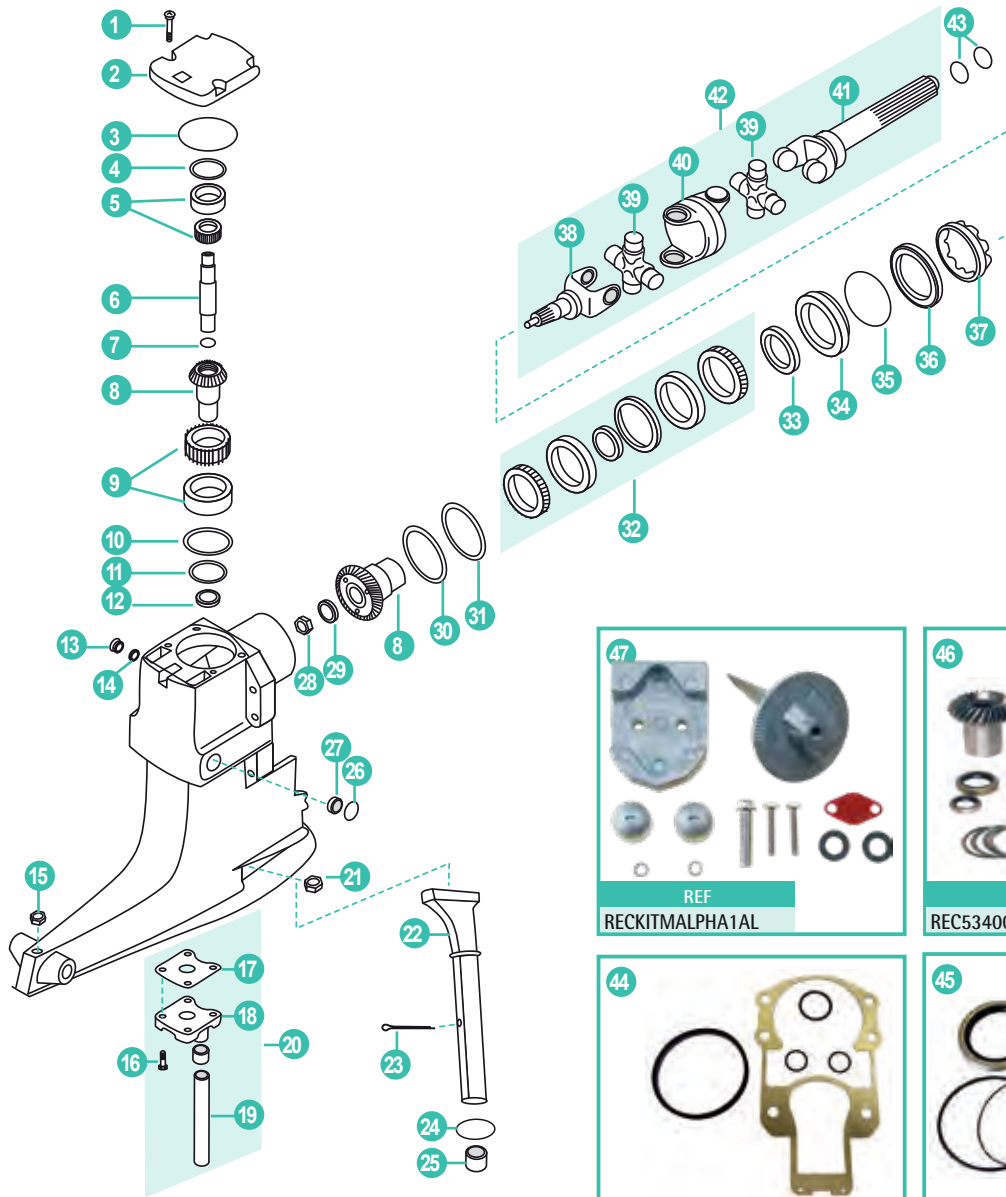

Abrazadera U de acoplamiento (39385A1) en modelos en línea.

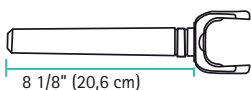

U-joint coupling end yoke (39385A1) used on older in-line models.

Il giogo terminale di giunzione a giunto U (39385A1) ha utilizzato i modelli on-line in linea.

Pince en U de couplage (39385A1) sur les modèles en ligne.

USO DE MODELOS ANTIGUOS DE COLAS EN MODELOS MERCURUISER IR-IMR

Mercury Marine no recomienda el uso de colas de modelos antiguos en modelos IR-IMR, ya que estas unidades no se acoplarán satisfactoriamente con el ensamblaje del transmisor. Además, las unidades en serie del modelo anterior, están equipadas con una horquilla de acoplamiento de unión en U (39385A1). Este eje es más corto que el (59830A1) usado en las unidades de impulsión de popa IR-IMR, y por lo tanto no acoplará completamente las estrías del motor. El uso del modelo más antiguo en un modelo de IR-IMR llevará al fallo de spline para acoplar al eje.

USE OF OLDER MODEL STERN DRIVE UNITS ON MERCURUISER IR-IMR MODELS

Mercury Marine does not recommend the use of older model stern drive units on IR-IMR models, as these units will not mate up satisfactorily with the transmisor assembly. In addition, the older model in-line stern drive units are equipped with U-joint coupling end yoke (39385A1). This yoke is shorter than yoke (59830A1) used on the IR-IMR stern drive units, and therefore will not fully engage the engine coupler splines. Use of an older in-line model stern drive unit on a IR-IMR model will result in a spline failure to coupling an/or yoke.

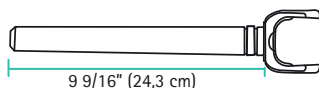

UTILIZZO DI MODELLI OLDER PIEDE SUI MODELLI IR-IMR MERCURUISER

Mercury Marine non ha raccomandato l'uso di unità di trasmissione a poppa più vecchie sui modelli IR-IMR, in quanto queste unità non si addicono in modo soddisfacente con l'assemblaggio del frangolo. In aggiunta, le unità di comando a poppa in linea in versione anteriore sono dotate di giogo terminale di giunzione a U (39385A1). Questo giogo è più corto del giogo (59830A1) usato sulle unità di azionamento a poppa IR-IMR e pertanto non impegnerà completamente le spline di accoppiatore del motore. L'uso di un'unità anteriore di tipo a poppa modello in linea su un modello IR-IMR provocherà un errore di spline per accoppiare un / o giogo.

UTILISATION DES QUEUES DE MODELES PLUS ANCIENS SUR LES MODELES MERCURUISER IR-IMR

Mercury Marine ne recommande pas l'utilisation d'anciens modèles de queues sur les modèles IR-IMR, car ces unités ne s'accoupleront pas de manière satisfaisante avec l'assemblage du tableau arrière. En outre, les unités de l'ancienne série sont équipées d'une fourche d'accouplement en U (39385A1). Cet arbre est plus court que le (59830A1) utilisé dans les unités d'entraînement arrière IR-IMR, et ne s'engage donc pas complètement dans les cannelures du moteur. L'utilisation de l'ancien modèle dans un modèle IR-IMR entraînera l'échec de l'accouplement des cannelures à l'arbre.

	REF	OEM				
1	REC10-98794	10-98794	TORNILLOS TAPA 3/8-16	SCREW 3/8-16	VITE 3/8-16	VIS 3/8-16
2	REC94998A4	94998A4	TAPA CON COJINETE	COVER ASSEMBLY	COPERCHIO CON CUSCINETTO	COUVERCLE AVEC ROULEMNT
3	REC25-32546	25-32546	ARO TÓRICO	O-RING	O-RING	JOINT TORIQUE
4	REC15-45691A1	15-45691A1	SUPLEMENTO (para REC31-61100A1)	SHIM (For REC31-61100A1)	SPESSORE (Per REC31-61100A1)	SUPPLEMENT (Pour REC31-61100A1)
	REC15-32563A1	15-32563A1	SUPLEMENTO (Para REC31-35988A12)	SHIM (For REC31-35988A12)	SPESSORE (Per REC31-35988A12)	SUPPLEMENT (Pour REC31-35988A12)
5	REC31-61100A1	31-61100A1	COJINETE Ø EXT. 49 mm	BEARING ASSY EXT. Ø 49 mm	CUSCINETTO Ø EST. 49 mm	ROULEMENT Ø EXT. 49 mm
	REC31-32575T1	31-32575T1	COJINETE Ø EXT. 45 mm	BEARING ASSY EXT.L Ø 45 mm	CUSCINETTO Ø EST. 45 mm	ROULEMENT Ø EXT. 45 mm
6	REC45-55796	45-55796	EJE PIÑÓN	DRIVE SHAFT	ASSE PIGNONE	ARBRE PIGNON
7	REC25-55801	25-55801	ARO TÓRICO	O-RING	O-RING	JOINT TORIQUE
	RM43-66773A3	43-66773A3	KIT PIÑONES (Red. 1.32) (16-20)	GEAR SET (1.32) (16-20)	KIT PIGNONI (Rid. 1.32) (16-20)	KIT PIGNON (Réd. 1.32) (16-20)
	REC43-18411A2	43-18411A2	KIT PIÑONES H.D. (Red.1.50) (20-22)	GEAR SET HD (1.50) (20-22)	KIT PIGNONI RINFORZATI (Rid.1.50) (20-22)	KIT PIGNON HD (Réd. 1.50) (20-22)
8	REC43-45814A5	43-45814A5	KIT PIÑONES (Red.1.65) (24-24)	GEAR SET (1.65) (24-24)	KIT PIGNONI (Rid.1.65) (24-24)	KIT PIGNON (Réd. 1.65) (24-24)
	REC43-75325A3	43-75325A3	KIT PIÑONES H.D. (Red.1.84) (17-19)	GEAR SET HD (1.84) (17-19)	KIT PIGNONI RINFORZATI (Rid.1.84) (17-19)	KIT PIGNON HD (Réd. 1.84) (17-19)
	REC43-55778A3	43-55778A3	KIT PIÑONES (Red.1.98) (20-24)	GEAR SET (1.98) (20-24)	KIT PIGNONI (Rid.1.98) (20-24)	KIT PIGNON (Réd. 1.98) (20-24)
	REC31-32573A1	31-32573A1	RODAMIENTO (Red.1.50) ANTIGUA	ROLLER BEARING (1.50) OLD	CUSCINETTO (Rid.1.50) VECCHIO	ROULEMENT (Réd. 1.50) ANCIEN
9	REC31-35990A1	31-35990A1	RODAMIENTO (Red.1.65-1.84-1.98)	ROLLER BEARING (1.65-1.84-1.98)	CUSCINETTO (Rid.1.65-1.84-1.98)	ROULEMENT (Réd. 1.65-1.84-1.98)
	REC31-66818A1	31-66818A1	RODAMIENTO (Red.1.32)	ROLLER BEARING (1.32)	CUSCINETTO (Rid.1.32)	ROULEMENT (Réd. 1.32)
10	REC15-36178A02	15-36178A02	SUPLEMENTO	SHIM	SPESSORE	SUPPLEMENT
11	REC26-32511	26-32511	RETÉN	OIL SEAL	PARAOLIO	JOINT D'HUILE
12	REC26-965031	26-965031	RETÉN	OIL SEAL	PARAOLIO	JOINT D'HUILE
13	REC10-79953Q04	10-79953Q04	TAPÓN ACEITE	SCREW	TAPPO OLIO	BOUCHON D'HUILE
14	REC12-191833	12-191833	JUNTA TAPÓN	WASHER	GUARNIZIONE TAPPO	JOINT BOUCHON
15	REC19-47579	19-47579	TAPA PLÁSTICO	PLUG	COPERCHIO IN PLASTICA	COUVERCLE PLASTIC
16	REC10-28668	10-28668	TORNILLO	SCREW	VITE	VIS
17	REC27-558101	27-55810 1	JUNTA	GASKET	GUARNIZIONE	JOINT
18	REC26-36557	26-36557	CASQUILLO GOMA	GROMMET	BOCCOLA IN GOMMA	JOINT CAOUTCHOUC
19	REC32-54236	32-54236	TUBO DE GOMA	WATER TUBE	TUBO IN GOMMA	DURITE CAOUTCHOUC
20	REC42724A3	42724A3	KIT REFRIGERACIÓN	WATER POCKET COVER KIT	KIT RIPARAZIONE	KIT REPARATION
21	REC11-34933	11-859116	TUERCA	NUT	DADO	ÉCROU
22	REC621041	621041	EJE SELECTOR	SELECTOR SHAFT	ASSE SELETTORE	ARBRE
23	REC18-32665	18-32665	PASADOR	PIN	FERMO	GOUPILLE
24	REC12-32666	12-32666	ARANDELA	WASHER	RONDELLA	RONDELLE
25	REC23-32632	23-32632	CASQUILLO	BUSHING	BOCCOLA	BAGUE
26	REC19-42682	19-42682	TAPÓN	WELCH PLUG (1-174 O.D.)	TAPPO	BOUCHON
27	REC22-428611	22-428611	TAPA TAPÓN	PIPE PLUG	COPERCHIO TAPPO	CUVERCLE BOUCHON
28	REC11-22339	11-22339	TUERCA	NUT	DADO	ÉCROU
29	REC12-45810	12-45810	ARANDELA TOPE	WASHER	RONDELLA	RONDELLE
30	REC15-71013	15-71013	SUPLEMENTO	SHIM	SPESSORE	SUPPLEMENT
31	REC15-35980A1	15-35980A1	SUPLEMENTO	SHIM	SPESSORE	SUPPLEMENT
32	REC31-35988A12	31-35988A12	RODAMIENTO (excepto 1.32)	ROLLER BEARING (except 1.32)	CUSCINETTO (eccetto 1.32)	ROULEMENT (except 1.32)
33	REC26-823894	26-823894	RETÉN	OIL SEAL	PARAOLIO	JOINT D'HUILE
34	REC66081A2	66081A2	CIERRE CARCASA	CARRIER ASSEMBLY	CHIUSURA CARCASSA	JOINT SPI DE CARDAN
35	REC25-70937	25-70937	ARO TÓRICO	O-RING	O-RING	JOINT TORIQUE
36	REC35983	35983	ARO METÁLICO	RING	O-RING METALLICO	BAGUE METALLIQUE
37	REC8168112	8168112	TUERCA PORTA RETÉN	RETAINER	DADO, SEDE PARAOLIO	ÉCROU À CRENAUX
38	REC46020T02	46020T02	EJE CORTO CARDÁN	YOKE	ASSE CARDANO	CARDAN
	REC3850812	75832T1	CRUCETA CARDÁN	U-JOINT	CROCIERA CARDANO	CROISILLON CARDAN
39	REC75832T	75832T	CRUCETA CARDÁN (4 en línea y V6)	U-JOINT (4 inline & V6)	CROCIERA CARDANO (4 in linea e V6)	CROISILLON CARDAN (4 en ligne et V6)
	REC805536A2	805536A2	CRUCETA AUTOENGRASE	U-JOINT SELF GREASE	CROCIERA AUTOINGRASSANTE	CROISILLON DE CARDAN
40	REC393831	393831	RÓTULA CARDÁN	SOCKET	SEDE CARDANO	CARDAN
41	REC59830A7	59830A7	EJE LARGO CARDÁN (9-9/16")	YOKE ASSEMBLY (9-9/16")	ASSE CARDANO (9-9/16")	CARDAN (9-9/16")
42	REC814819A2	814819A2	CARDÁN COMPLETO	U-JOINT ASSEMBLY	CARDANO COMPLETO	CARDAN COMPLET
43	REC25-25439	25-25439	ARO TÓRICO	O-RING	O-RING	JOINT TORIQUE
44	REC27-64818Q4	26-64818Q4 27-64718A1	KIT DE JUNTAS	GASKET KIT	KIT GUARNIZIONE	KIT JOINTS
45	REC26-32511A1	26-32511A1	KIT DE JUNTAS	GASKET KIT	KIT GUARNIZIONE	KIT JOINTS
46	REC43-18411A2	43-18411A4	KIT PIÑONES Y COJINETE Reforzados 20/22 (Red. 1.50) Para V8.	DRIVE SHAFT HOUSING GEAR SET Heavy duty 20/22 (ratio 1.50) for V8	KIT PIGNONI E CUSCINETTI Rinforzati 20/22 Denti (Rid. 1.50) Per V8.	KIT PIGNON ET ROULEMENTS Renforcé 20/22 (Réd. 1.50) Pour V8.
47	RECKITMALPHA1AL		KIT ÁNODOS ALUMINIO	ANODES KIT AL	KIT ANODI AL	KIT ANODES AL

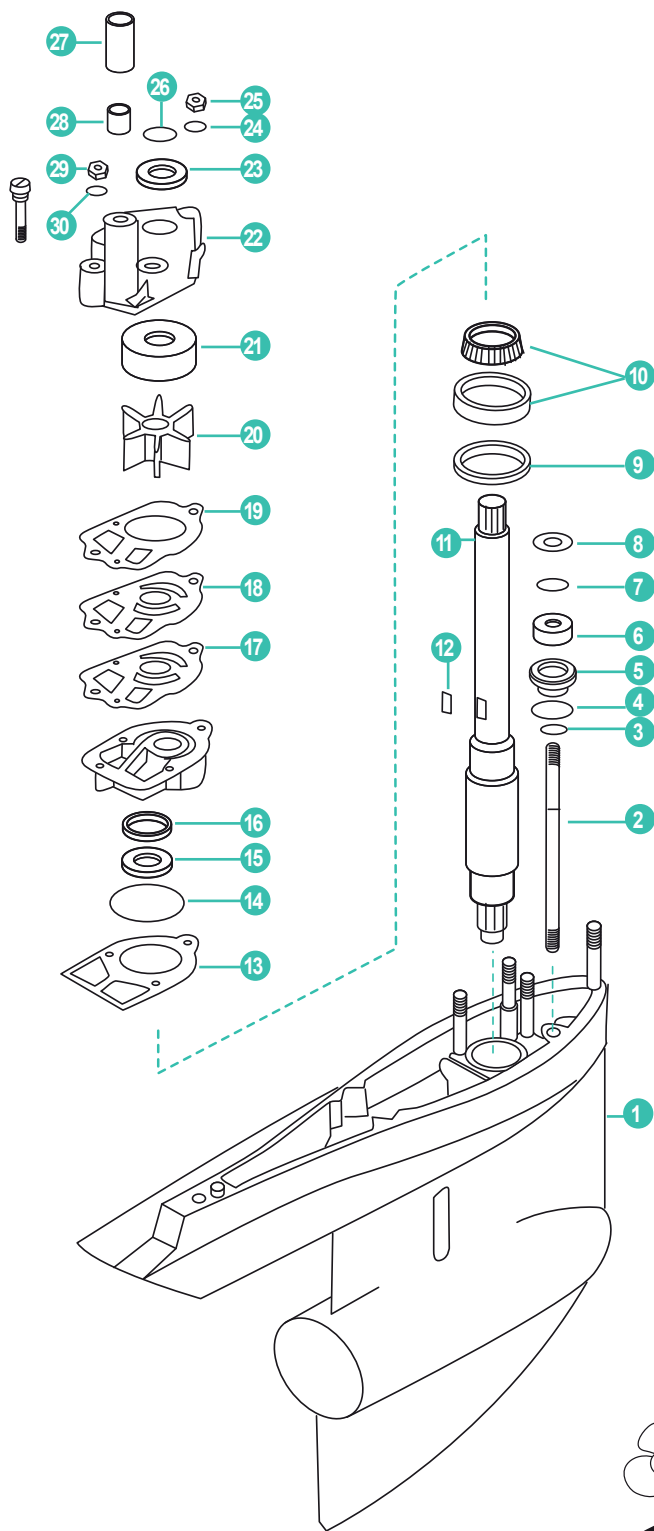

	REF	OEM				
1	REC1623-5356A4	1623-5356A4	CARACA	HOUSING	CARCASSA	ENSEMBLE BOITIER DE VITESSE
2	REC774811	774811	EJE TRANSMISIÓN	SHIFT	ASSE	ARBRE
3	REC12-27880	12-27880	ARO	O-RING	O-RING	JOINT TORIQUE
4	REC25-25439	25-25439	ARO TÓRICO	O-RING	TENUTA	JOINT TORIQUE
5	REC23-30617A2	23-30617A2	ACOPLE EJE	ATTACHING SHAFT	FISSAGGIO ASSE	BUSING DE L'ARBRE DE TRANSMISSION
6	REC26-8164641	26-8164641	RETÉN	SEAL	TENUTA	JOINT D'HUILE
7	REC12-31266	12-31266	ARANDELA	WASHER	RONDELLA	RONDELLE
8	REC8M0042641	12-8M0042641	ARANDELA	WASHER	RONDELLA	RONDELLE
9	REC15-57007A1	15-57007A1	SUPLEMENTO	SPACER	DISTANZIALE	SUPPLEMENT
10	REC31-53079A1	31-53079A1	RODAMIENTO	BEARING	CUSCINETTO	ROULEMENT
11	REC45-41939F1	45-41939F1	EJE TRANSMISIÓN	TRANSMISSION SHAFT	ASSE TRASMISSIONE	ARBRE TRANSMISSION
12	REC8M0032834	28-8M0032834	CHAVETA	KEY	CHIAVETTA	CLAVETTE
13	REC27-856704	27-856704	JUNTA	GASKET	GUARNIZIONE	JOINT
14	REC25-33145	25-33145	ARO TÓRICO	O-RING	O-RING	JOINT TORIQUE
15	REC26-89238	26-89238	RETÉN	SEAL	TENUTA	JOINT D'HUILE
16	REC26-16977	26-16977	RETÉN	SEAL	TENUTA	JOINT D'HUILE
17	REC27-856081	27-856081	JUNTA BOMBA	PUMP GASKET	GUARNIZIONE POMPA	JOINT POMPE
18	REC324351	324351	TAPA BOMBA AGUA	COVER	COPERCHIO POMPA ACQUA	COUVERCLE POMPE À EAU
19	REC27-858524	27-858524	JUNTA TAPA BOMBA	COVER GASKET	GUARNIZIONE COPERCHIO	JOINT COUVERCLE POMPE
20	REC47-89984T4	47-89984T4	IMPULSOR	IMPELLER	GIRANTE	TURBINE
21	REC48752T	48752T	CASQUILLO BOMBA	INSERT	BOCCOLA	INSERT
22	REC46-96148T1	46-96148T1	CUERPO BOMBA AGUA	HOUSING WATER PUMP	CORPO POMPA ACQUA	CORPS POMPE À EAU
23	REC25-30271	25-30271	ARANDELA	WASHER	RONDELLA	RONDELLE
24	PAGB/T97.1-8	12-36001	ARANDELA	WASHER	RONDELLA	RONDELLE
25	REC11-13436	11-13436	TUERCA	NUT	DADO	ÉCROU
26	REC25-30613	25-30613	ANILLO GOMA	RUBBER RING	TENUTA	JOINT À CAOUTCHOUC
27	REC23-29804T	23-29804T	TUBO GUÍA	WATER PIPE	TUBO	TUYAU
28	REC26-38970	26-38970	RETÉN	OIL SEAL	TENUTA	JOINT D'HUILE
29	REC11-8267089	11-8267089	TUERCA	NUT	DADO	ÉCROU
30	PAGB/T848-6	12-29245	ARANDELA	WASHER	RONDELLA	RONDELLE
31	REC12110		KIT REPARACIÓN (1970-83)	SEAL KIT (1970-83)	KIT RIPARAZIONE (1970-83)	KIT POMPE (1970-83)
32	REC47-89984Q5		KIT REPARACIÓN	SEAL KIT	KIT RIPARAZIONE	KIT POMPE
33	REC46-64141A11		KIT REPARACIÓN MC1 (-1968)	SEAL KIT MC1 (-1968)	KIT RIPARAZIONE MC1 (-1968)	KIT POMPE MC1 (-1968)
34	REC26-33144A2	26-33144A2	KIT REPARACIÓN	SEAL KIT	KIT RIPARAZIONE	KIT POMPE



MC1 / R

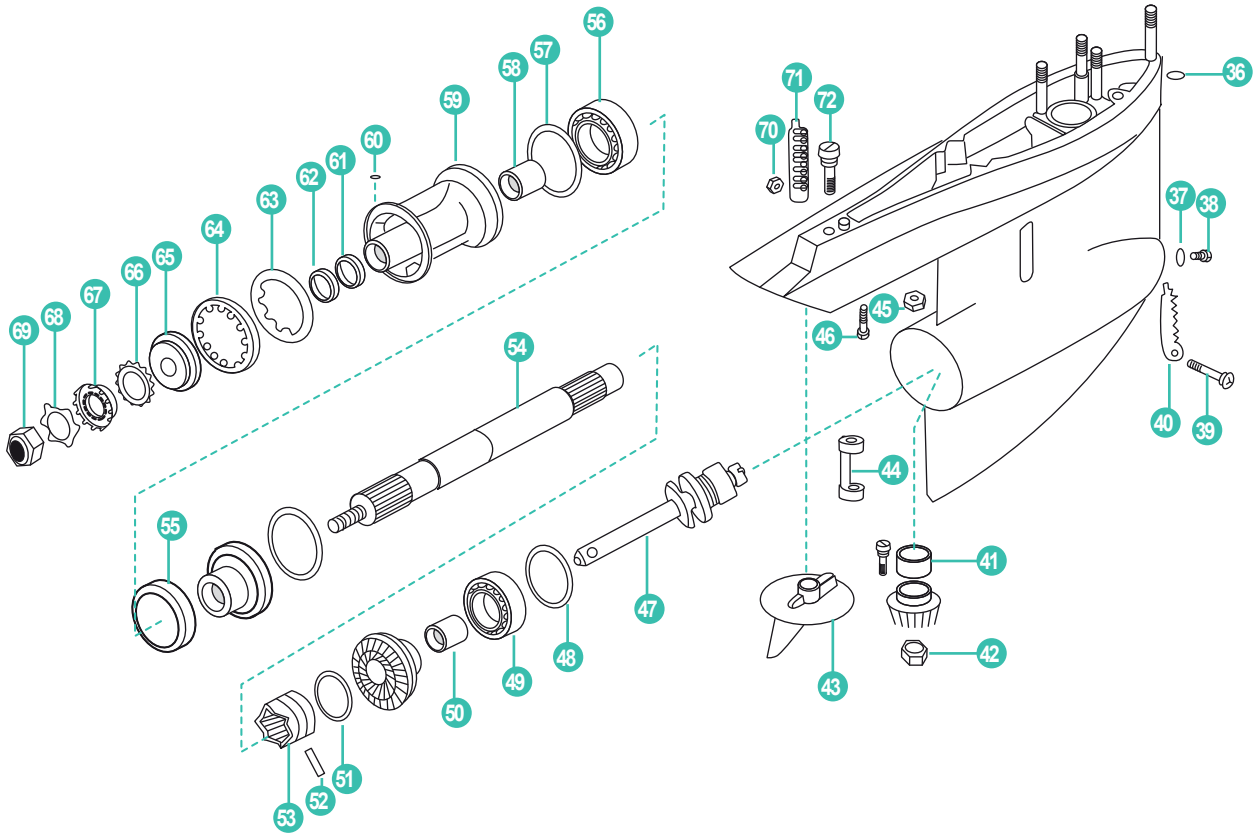

	REF	OEM				
36	REC26-455771	26-455771	RETÉN	SEAL	TENUTA	JOINT D'HUILE
37	REC12-191833	12-191833	JUNTA	GASKET	GUARNIZIONE	JOINT
38	REC22-67892A05	8M0058389	TORNILLO CON RETÉN	SCREW WITH SEAL	VITE CON TENUTA	VIS AVEC JOINT
39	REC10-76156	10-76156	TORNILLO	SCREW	VITE	VIS
40	REC934231	934231	TAPA REFRIGERACIÓN	CAP	COPERCHIO	COUVERCLE
41	REC31-92366A1	31-92366A1	RODAMIENTO	BEARING	CUSCINETTO	ROULEMENT
42	REC11-35921	11-35921	TUERCA PIÑÓN	PINION NUT	PIGNONE DADO	PIGNON ÉCROU
43	CM31640	31640Q4	ANODO TIMÓN ZN	ZN ANODE	ANODO ZN	ANODE ZN
	CM31640A	31640Q4	ANODO TIMÓN AL	AL ANODE	ANODO AL	ANODE AL
44	REC76865	76865	HORQUILLA CAMBIO	CLIP	CLIP CAMBIO	FOURCHETTE
45	REC11-34933	11-859116	TUERCA	NUT	DADO	ÉCROU
46	REC10-30206	10-30206	TORNILLO	SCREW	VITE	VIS
47	REC818349T1	818349T1	EJE DESPLAZABLE	SLIDE SHIFT	PASSANTE	SELECTEUR D'INVERSEUR
48	REC15-47397A1	15-47397A1	ARANDELA	WASHER	RONDELLA	RONDELLE
49	REC31-35928T1	31-35928T1	RODAMIENTO	BEARING	CUSCINETTO	ROULEMENT
50	REC31-30895T	31-30895T	RODAMIENTO	BEARING	CUSCINETTO	ROULEMENT
51	REC31-30895T	24-30893	MUELLE	SPRING	MOLLA	RESSORT
52	REC17-8M0084681	8M0020941	PASADOR	PIN	SPINOTTO	GOUPILLE
53	REC52-853594T	52-853594T	PIÑÓN CAMBIO	SHAFT PINION	PIGNONE CAMBIO	PIGNON CHANGEMENT
54	REC44-824110	44-824110	EJE HÉLICE	SHAFT PROPELLER	ASSE ELICA	ARBRE HÉLICE
55	REC35915	35915	SEPARADOR PIÑÓN	SPACER PINION	DISTANZIALE PIGNONE	ENTRETOISE DE PIGNON
56	REC30-88957T	30-88957T	RODAMIENTO	BEARING	CUSCINETTO	ROULEMENT
57	REC25-31534	25-31534	ARO TÓRICO	O-RING	ANELLO	JOINT TORIQUE
58	REC387247	31-30956T	RODAMIENTO	BEARING	CUSCINETTO	ROULEMENT
59	REC818763A10	818763A10	COJINETE COLA	SHAFT BEARING	CUSCINETTO PIEDE	ROULEMENT EMBASE
60	REC28-30281	28-30281	CIERRE	CAP	CHIUSURA	CLAVETTE
61	REC26-76868	26-76868	RETÉN INTERIOR	INNER SEAL	TENUTA INTERNO	JOINT TORIQUE
62	REC26-12224	26-12224	RETÉN EXTERIOR	OUTLER SEAL	TENUTA ESTERNO	JOINT D'HUILE
63	REC14-79447	14-79447	ARANDELA CIERRE	WASHER CAP	RONDELLA CHIUSURA	RONDELLE
64	REC8M2011027	8M2011027	TUERCA	NUT	DADO	ÉCROU
65	REC12-835467Q01	12-835467Q01	SEPARADOR	SPACER	DISTANZIALE	RONDELLE D'HÉLICE
66	REC13-423511	13-42351-1	ARANDELA CIERRE	WASHER CAP	RONDELLA CHIUSURA	RONDELLE FREIN
67	REC12-31211Q03	12-31211Q03	CASQUILLO	INSERT, CARTDRIGE	GHIERA	RONDELLE FREIN DE DIABOLO
68	REC90508-ZW1-003	816629Q	ARANDELA TUERCA	WASHER NUT	RONDELLA DADO	RONDELLE ÉCROU
69	REC90301-ZW1-003	11-827614	TUERCA EJE	NUT SHAFT	DADO ASSE	ÉCROU D'ARBRE
70	REC11-859124	11-859124	TUERCA	NUT	DADO	ÉCROU
71	REC934241	934241	TAPA REFRIGERACIÓN	CAP	COPERCHIO	COUVERCLE
72	REC10-32470	10-32470	TORNILLO	SCREW	VITE	VIS
73	REC11-52707Q1	11-52707Q1	KIT CIERRE HÉLICE	PROPELLER NUT KIT	KIT CIUSSURA ELICHA	KIT ÉCROU D'HÉLICE
	RECKITM1ALPHA1AL		KIT ÁNODOS AL	ANODE KIT AL	KIT ANODI AL	KIT ANODES AL
	CMALPHAGEN1KITA		KIT ÁNODOS AL	ANODE KIT AL	KIT ANODI AL	KIT ANODES AL
74	CMALPHAGEN1KITM		KIT ÁNODOS MG	ANODE KIT MG	KIT ANODI MG	KIT ANODES MG
	TENKITALPHAONE/1		KIT ÁNODOS ZN	ANODE KIT ZN	KIT ANODI ZN	KIT ANODES ZN

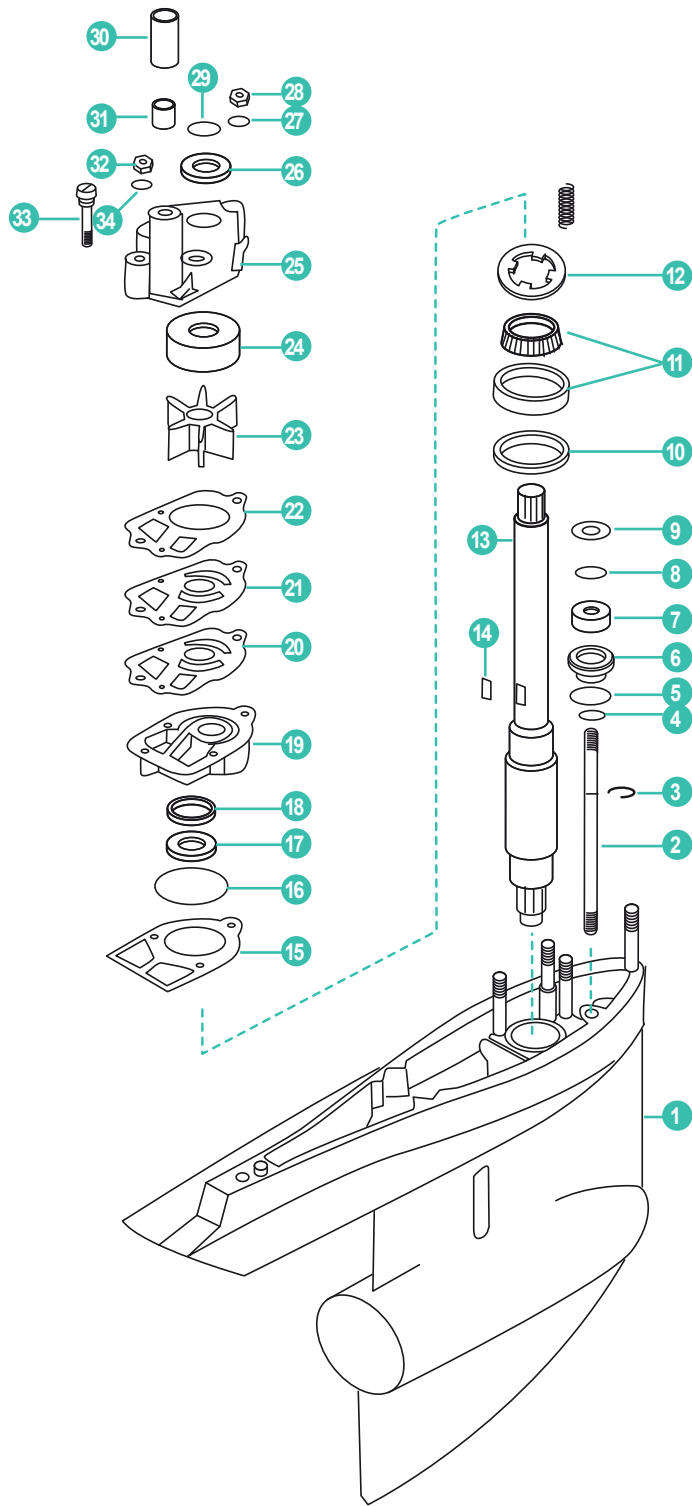

	REF	OEM				
1	REC1623-8951A37	1623-8951A37	CARCASA	HOUSING	CARCASSA	CARTER EMBASE
2	REC774811	774811	EJE TRANSMISIÓN	SHIFT	ASSE	ARBRE TRANSMISSION
3	REC53-29641	53-29641	CLIP	LOCKER	CLIP	CLIPS
4	REC12-27880	12-27880	ARO	O-RING	O-RING	JOINT TORIQUE
5	REC25-25439	25-25439	ARO TÓRICO	O-RING	O-RING	JOIN TORIQUE
6	REC23-30617A2	23-30617A2	ACOPLE EJE	ATTACHING SHAFT	FISSAGGIO ASSE	BUSING DE L'ARBRE
7	REC26-8164641	26-8164641	RETÉN	SEAL	TENUTA	JOINT D'HUILE
8	REC12-31266	12-31266	ARANDELA	WASHER	RONDELLA	RONDELLE
9	REC8M0042641	8M0042641	ARANDELA	WASHER	RONDELLA	RONDELLE
10	REC15-42637A1	15-42637A1	GRUESO	SHIM	SPESSORE	KIT CALE D'EPaisseur
11	REC31-36387A1	31-36387A1	RODAMIENTO	BEARING	CUSCINETTO	ROULEMENT
12	REC8245191	8245191	ARANDELA	WASHER	RONDELLA	RONDELLE
13	REC45-42634	45-42634	EJE TRANSMISIÓN	TRANSMISSION SHAFT	ASSE TRASMISIONE	ARBRE DE TRANSMISSION
14	REC8M0032834	8M0032834	CHAVETA	KEY	CHIAVETTA	CLAVETTE
15	REC27-426311	27-42631-1	JUNTA	GASKET	GUARNIZIONE	JOINT
16	REC25-38099	25-38099	ARO TÓRICO (Ø 2.125")	O-RING (Ø 2.125")	O-RING (Ø 2.125")	JOINT TORIQUE (Ø 2.125")
	REC25-90011	25-90011	ARO TÓRICO (Ø 2.188")	O-RING (Ø 2.188")	O-RING (Ø 2.188")	JOINT TORIQUE (Ø 2.188")
17	REC26-89238	26-89238	RETÉN	SEAL	TENUTA	JOINT D'HUILE
18	REC26-16977	26-16977	RETÉN	SEAL	TENUTA	JOINT D'HUILE
19	REC46-44292Q03	46-44292Q03	BASE BOMBA	PUMP BASE	BASE POMPA	BASE POMPE
20	REC27-856081	27-856081	JUNTA BOMBA	PUMP GASKET	GUARNIZIONE POMPA	JOINT POMPE
21	REC324351	324351	TAPA BOMBA AGUA	COVER	COPERCHIO	COUVERCLE POMPE
22	REC27-858524	27-858524	JUNTA TAPA BOMBA	COVER GASKET	GUARNIZIONE COPERCHIO	JOINT COUVERCLE
23	REC47-89984T4	47-89984T4	IMPULSOR	IMPELLER	GIRANTE	TURBINE
24	REC48752T	48752T	CASQUILLO BOMBA	INSERT	BOCCOLA	INSERT
25	REC46-96148T1	46-96148T1	CUERPO BOMBA AGUA	HOUSING WATER PUMP	CORPO POMPA ACQUA	CORPS POMPE
26	REC25-30271	25-30271	RETÉN	SEAL	TENUTA	JOINT
27	PAGB/T97.1-8	12-36001	ARANDELA	WASHER	RONDELLA	RONDELLE
28	REC11-13436	11-13436	TUERCA	NUT	DADO	ÉCROU
29	REC25-30613	25-30613	ARO TÓRICO	O-RING	O-RING	JOINT TORIQUE
30	REC23-29804T	23-29804T	TUBO GUÍA	WATER PIPE	TUBO	TUYAU
31	REC26-38970	26-38970	RETÉN	SEAL	TENUTA	JOINT
32	REC11-8267089	11-8267089	TUERCA	NUT	DADO	ÉCROU
33	REC10-96411	10-96411	TORNILLO	SCREW	VITE	VIS
34	PAGB/T848-6	12-29245	ARANDELA	WASHER	RONDELLA	RONDELLE
35	REC12120		KIT REPARACIÓN	SEAL KIT	KIT RIPARAZIONE	KIT POMPE A EAU
36	REC47-89984Q5		KIT REPARACIÓN	SEAL KIT	KIT RIPARAZIONE	KIT POMPE A EAU
37	REC26-33144A2	26-33144A2	KIT REPARACIÓN	SEAL KIT	KIT RIPARAZIONE	KIT POMPE A EAU

MR / ALPHA ONE

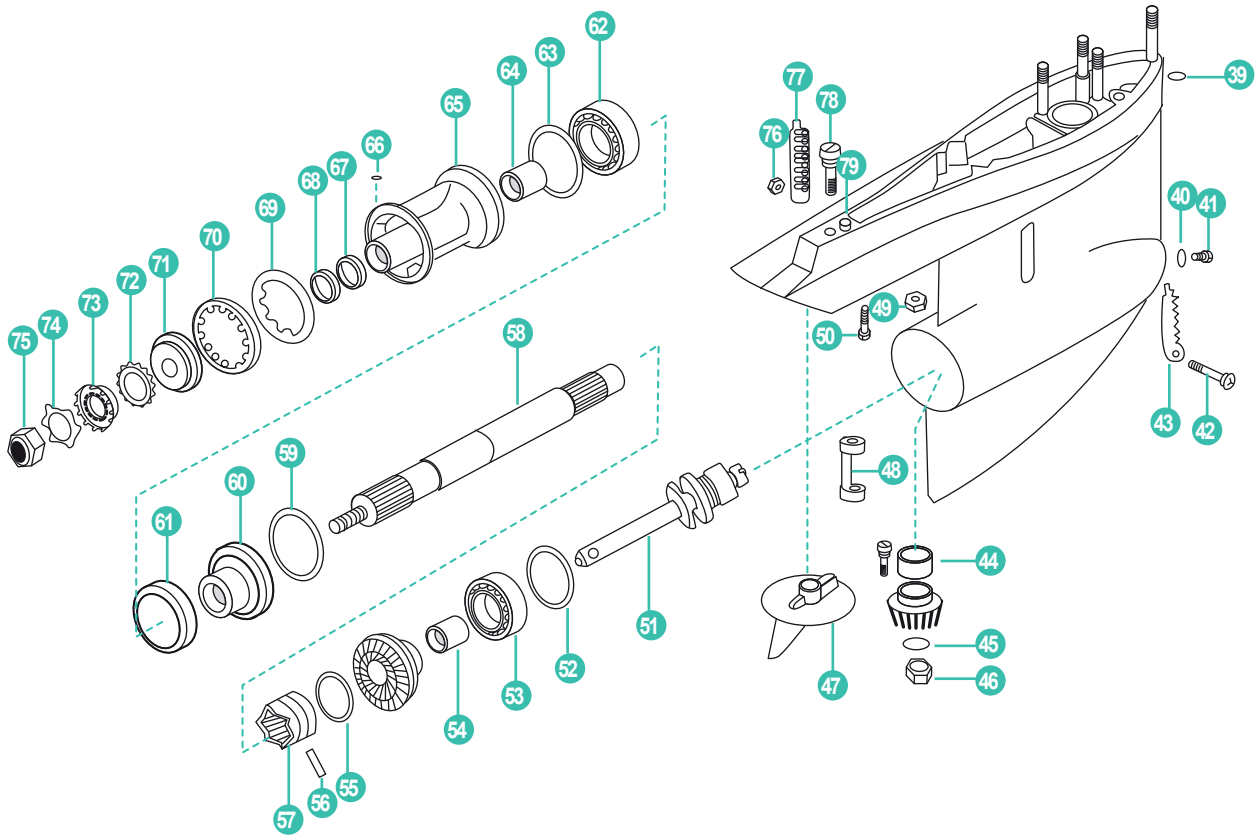

	REF	OEM				
39	REC26-455771	26-45577 1	RETÉN	SEAL	TENUTA	JOINT D'HUILE
40	REC12-191833	12-191833	JUNTA	GASKET	GUARNIZIONE	JOINT
41	REC22-67892A05	8M0058389	TORNILLO CON RETÉN	SCREW WITH SEAL	VITE CON TENUTA	VIS AVEC JOINT
42	REC10-76156	10-76156	TORNILLO	SCREW	VITE	VIS
43	REC934231	934231	TAPA REFRIGERACIÓN	CAP	COPERCHIO	COUVERCLE
44	REC387817	31-42647A1	RODAMIENTO	BEARING	CUSCINETTO	ROULEMENT
45	REC350038	12-92721	CIERRE	CAP	CHIUSURA	JOINT
46	REC11-35921	11-35921	TUERCA PIÑÓN	PINION NUT	DADO PIGNONE	ÉCROU PIGNON
47	CM31640	31640Q4	ANODO TIMÓN ZN	ZN SHAFT ANODE	ANODO ZN	ANODE ZN
	CM31640A	31640Q4	ANODO TIMÓN AL	AL SHAFT ANODE	ANODO AL	ANODE AL
48	REC76865	76865	HORQUILLA CAMBIO	CLIP	CLIP	FOURCHETTE
49	REC11-34933	11-859116	TUERCA	NUT	DADO	ÉCROU
50	REC10-30206	10-30206	TORNILLO	SCREW	VITE	VIS
51	REC818349T1	818349T1	EJE DESPLAZABLE	SLIDE SHIFT	PASSANTE	SELECTEUR D'INVERSEUR
52	REC15-47397A1	15-47397A1	ARANDELA	WASHER	RONDELLA	RONDELLE
53	REC31-35928T1	31-35928T1	RODAMIENTO Ø 47,6 mm	BEARING Ø 47.6 mm	CUSCINETTO Ø 47.6 mm	ROULEMENT Ø 47,6 mm
	REC31-828437A2	31-828437A2	RODAMIENTO Ø 44,4 mm	BEARING Ø 44.4 mm	CUSCINETTO Ø 44.4 mm	ROULEMENT Ø 44.4 mm
54	REC31-30895T	31-30895T	RODAMIENTO	BEARING	CUSCINETTO	ROULEMENT
55	REC24-30893	24-30893	MUELLE	SPRING	MOLLA	RESSORT
56	REC17-8M0084681	8M0020941	PASADOR	PIN	SPINOTTO	GOUPILLE
57	REC52-853594T	52-853594T	PIÑÓN CAMBIO	SHAFT PINION	PIGNONE CAMBIO	CRABOT
58	REC44-824110	44-824110	EJE HÉLICE	SHAFT PROPELLER	ASSE ELICA	ARBRE D'HÉLICE
	REC44-8146061	44-8146061	EJE HÉLICE	SHAFT PROPELLER	ASSE ELICA	ARBRE D'HÉLICE
59	REC23-824108	23-824108	ESPACIADOR	SPACER	DISTANZIALE	CALE
60	REC43-828073A1	43-828073A1	PIÑÓN MARCHA A ATRÁS	PINION REVERSE	PIGNONE RETROMARCIA	PIGNON MARCHE ARRIÈRE
61	REC681001	681001	SEPARADOR PIÑÓN	PINION SPACER	DISTANZIALE PIGNONE	CALE
62	REC30-88957T	30-88957T	RODAMIENTO	BEARING	CUSCINETTO	ROULEMENT
63	REC25-31534	25-31534	ARO TÓRICO	O-RING	ANELLO	JOINT TORIQUE
64	REC387247	31-30956T	RODAMIENTO	BEARING	CUSCINETTO	ROULEMENT
65	REC818763A10	818763A10	COJINETE COLA	SHAFT BEARING	CUSCINETTO PIEDE	DIABOLO
	REC14587A7	14587A5	COJINETE COLA	SHAFT BEARING	CUSCINETTO PIEDE	DIABOLO
66	REC28-30281	28-30281	CHAVETA	KEY	CHIAVETTA	CLAVETTE
67	REC26-76868	26-76868	RETÉN INTERIOR	INNER SEAL	TENUTA INTERNO	JOINT TORIQUE
68	REC26-12224	26-12224	RETÉN EXTERIOR	OUTLER SEAL	TENUTA ESTERNO	JOINT TORIQUE
69	REC14-18323	14-18323	ARANDELA CIERRE	WASHER	RONDELLA CHIUSURA	RONDELLE
70	REC8M2011027	8M2011027	TUERCA	NUT	DADO	ÉCROU
71	REC12-835467Q01	12-835467Q01	SEPARADOR	SPACER	DISTANZIALE	CALE
72	REC13-423511	13-423511	ARANDELA CIERRE	WASHER	RONDELLA CHIUSURA	RONDELLE
73	REC12-31211Q03	12-31211Q03	CASQUILLO	INSERT	BOCCOLA	INSERT
74	REC90508-ZW1-003	14-816629Q	ARANDELA TUERCA	WASHER NUT	RONDELLA DADO	RONDELLE ÉCROU
75	REC90301-ZW1-003	11-827614	TUERCA EJE	SHAFT NUT	DADO ASSE	ÉCROU ARBRE
76	REC11-859124	11-859124	TUERCA	NUT	DADO	ÉCROU
77	REC934241	934241	TAPA REFRIGERACIÓN	CAP	COPERCHIO	COUVERCLE
78	REC10-32470	10-32470	TORNILLO	SCREW	VITE	VIS
79	REC331880	17-35973	PASADOR	PIN	SPINOTTO	GOUPILLE
80	REC11-52707Q1	11-52707Q1	KIT CIERRE HÉLICE	PROPELLER NUT KIT	KIT CHIUSURA ELICHA	KIT ÉCROU D'HÉLICE
81	RECKITMALPHA1AL		KIT ÁNODOS AL	ANODE KIT AL	KIT ANODI AL	KIT ANODES AL
	CMALPHAGEN1KITA		KIT ÁNODOS AL	ANODE KIT AL	KIT ANODI AL	KIT ANODES AL
	CMALPHAGEN1KITM		KIT ÁNODOS MG	ANODE KIT MG	KIT ANODI MG	KIT ANODES MG
	TENKITALPHAONE/1		KIT ÁNODOS ZN	ANODE KIT ZN	KIT ANODI ZN	KIT ANODES ZN
82	CM806105	806105Q1	ÁNODO EJE HÉLICE ZN	PROP SHAFT ANODE ZN	ANODO ELICHA ZN	ANODE EMBASE ZN
	CM806105A	806105Q1	ÁNODO EJE HÉLICE AL	PROP SHAFT ANODE AL	ANODO ELICHA AL	ANODE EMBASE AL



CONTRAROTACIÓN
ROTACIÓN ESTÁNDAR

COUNTER ROTATION
STD ROTATION

CONTROROTANTE
ROTAZIONE STD

CONTRAROTATION
ROTATION STD

ALPHA ONE GEN II
OD469859-0K999999 (1991-97)

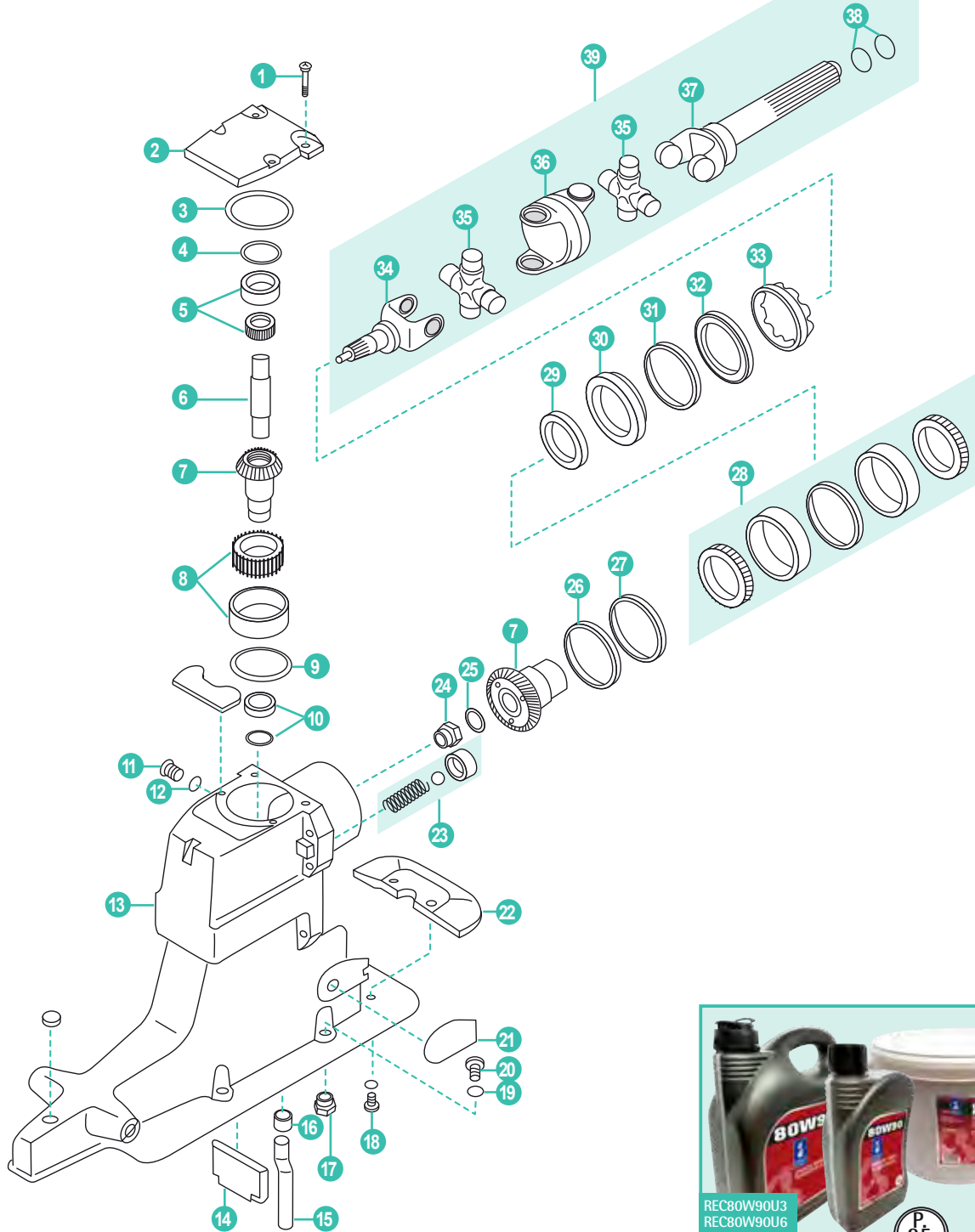

	REF	OEM				
1	REC10-98794	10-98794	TORNILLO	SCREW	VITE	VIS
2	REC828692A1	828692A1	TAPA SUPERIOR CON NIVEL DE ACEITE	UPPER CAP WITH OIL LEVEL	COPERCHIO SUPERIORE CON LIVELLO OLIO	KIT CAPOT SUPERIEUR
3	REC25-32546	25-32546	ARO TÓRICO	O-RING	O-RING	JONT TORIQUE
4	REC15-45691A1	15-45691A1	GRUESO (Para rodamiento 21510)	SHIM (For bearing 21510)	SPESSORE (Per cuscinetto 21510)	CALE (pour roulement 21510)
	REC15-32563A1	15-32563A1	GRUESO (Para rodamiento 21511)	SHIM (For bearing 21511)	SPESSORE (Per cuscinetto 21511)	CALE (pour roulement 21511)
5	REC31-61100A1	31-61100A1	RODAMIENTO Ø EXT.49 mm (1991-95)	BEARING Ø EXT. 49 mm (1991-95)	CUSCINETTO Ø EST. 49 mm (1991-95)	ROULEMENT Ø EXT. 49 mm (1991-95)
	REC31-32575T1	31-32575T1	RODAMIENTO Ø EXT.45 mm (-1996)	BEARING Ø EXT. 45 mm (-1996)	CUSCINETTO Ø EST. 45 mm (-1996)	ROULEMENT Ø EXT. 45 mm (-1996)
6	REC45-557961	45-55796-1	EJE PIÑÓN	PINION SHAFT	ASSE PIGNONE	ARBRE PIGNON
	REC43-18411A2	43-18411A2	KIT PIÑONES (Red.1.50/1.47) (20-22) 1991-97	PINION KIT (Ratio 1.50/1.47) (20-22) 1991-97	KIT PIGNONE (Rid. 1.50/1.47) (20-22) 1991-97	KIT PIGNON (Réd. 1.50/1.47) (20-22) 1991-97
	REC43-45814A5	43-45814A5	KIT PIÑONES (Red 1.65/1.62) (24-24) 1991-97	PINION KIT (Ratio 1.65/1.62) (24-24) 1991-97	KIT PIGNONE (Rid. 1.65/1.62) (24-24) 1991-97	KIT PIGNON (Réd. 1.65/1-62) (24-24) 1991-97
7	REC43-75325A3	43-75325A3	KIT PIÑONES (Red 1.84/1.81) (17-19) 1991-97	PINION KIT (Ratio 1.84/1.81) (17-19) 1991-97	KIT PIGNONE (Rid. 1.84/1.81) (17-19) 1991-97	KIT PIGNON (Réd. 1.84/1.81) (17-19) 1991-97
	REC43-55778A3	43-55778A3	KIT PIÑONES (Red 1.98/1.94) (20-24) 1991-97	PINION KIT (Ratio 1.98/1.94) (20-24) 1991-97	KIT PIGNONE (Rid. 1.98/1.94) (20-24) 1991-97	KIT PIGNON (Réd. 1.98/1.94) (20-24) 1991-97
8	REC31-35990A1	31-35990A1	RODAMIENTO (Red 1.65, 1.84, 1.98, 2.40)	BEARING (Ratio 1.65, 1.84, 1.98, 2.40)	CUSCINETTO (Rid. 1.65, 1.84, 1.98, 2.40)	ROULEMENT (Réd. 1.65, 1.84, 1.98, 2.40)
	REC31-32573A1	31-32573A1	RODAMIENTO (Red. 1.47)	BEARING (Ratio 1.47)	CUSCINETTO (Rid.1.47)	ROULEMENT (Réd. 1.47)
9	REC15-36178A02	15-36178A02	SUPLEMENTO	SPACER	DISTANZIALE	CALE
10	REC26-66302	26-66302	RETÉN	SEAL	TENUTA	JOINT
11	REC10-79953Q04	10-79953Q04	TORNILLO COLA	SCREW	VITE	VIS
12	REC12-191833	12-191833	JUNTA	GASKET	GUARNIZIONE	JOINT
13	REC1547-815930A7	1547-815930A7	CARCASA	HOUSING	CARASSA	CARDAN
14	RM815932	815932	SEPARADOR ESCAPE	SPACER EXHAUST	SPAZIATORE SCARICO	CALE ÉCHAPPEMENT
15	REC32-860220	32-860220	TUBO SUBIDA AGUA	WATER UP TUBE	TUBO ASPIRAZIONE ACQUA	DURITE D'EAU
16	REC26-88397	26-88397	TUBO GOMA	RUBBER TUBE	TUBO GOMMA	DURITE CAOUTCHOUC
17	REC11-859135	859135	TUERCA	NUT	DADO	ÉCROU
18	REC10-28668	10-28668	TORNILLO	SCREW	VITE	VIS
19	REC12-45176	12-35935	ARANDELA	WASHER	RONDELLA	RONDELLE
20	REC10-816601	10-816601	TORNILLO	SCREW	VITE	VIS
21	REC8M2015937	8M2015937	TAPA BABOR	PORT CAP	COPERCHIO SINISTRO	COUVERCLE BABOR
	REC8M2015938	8M2015938	TAPA ESTRIBOR	STD CAP	COPERCHIO DESTRO	COUVERCLE TRIBOR
22	CM821629	821629Q1	ANODO ZN	ZN ANODE	ANODO ZN	ANODE ZN
	CM821629A	821629Q1	ANODO AL	ALANODE	ANODO AL	ANODE AL
23	REC24-17997A1	24-17997A1	KIT MUELLE BOLA	SPRING BALL KIT	KIT MOLLA	KIT RESSORT
24	REC11-22339	11-22339	TUERCA	NUT	DADO	ÉCROU
25	REC12-45810	12-45810	ARANDELA	WASHER	RONDELLA	RONDELLE
26	REC15-71013	15-71013	ESPACIADOR	SPACER	DISTANZIALE	CALE
27	REC15-35980A1	15-35980A1	SUPLEMENTO	SPACER	DISTANZIALE	CALE
28	REC31-35988A12	31-35988A12	RODAMIENTO (1991-97)	BEARING (1991-97)	CUSCINETTO (1991-97)	ROULEMENT (1991-97)
29	REC26-823894	26-823894	RETÉN	SEAL	TENUTA	JOINT D'HUILE
30	REC66081A2	66081A2	CUERPO RETÉN CARDAN	HOUSING CARDAN SEAL	PARAOILIO CARDANO	CORPS JOINT DU CARDAN
31	REC25-70937	25-70937	ARO TÓRICO	O-RING	O-RING	JOINT TORIQUE
32	REC35983	35983	ARO	O-RING	O-RING	JOINT TORIQUE
33	REC8168112	8168112	TUERCA PORTA RETÉN	SEAL'S NUT	DADO PORTA TENUTA	ÉCROU A CRENAUX EMBASE
34	REC46020T02	46020T02	UNIÓN COLA-CARDAN (1991-97)	UNION DRIVE SHAFT-CARDAN (1991-97)	ASSE CARDANO PIEDE (1991-97)	CARDAN (1991-97)
	REC3850812	75832T1	CRUCETA (1991-95)	JOINT (1991-95)	CROCETTA (1991-95)	CROISILLON CARDAN (1991-95)
35	REC805536A2	805536A2	CRUCETA (1996+)	JOINT (1996+)	CROCETTA (1996+)	CROISILLON CARDAN (1996+)
	REC75832T	75832T	CRUCETA CARDÁN (4 en línea y V6) (-1995)	U-JOINT (4 inline & V6) (-1995)	CROCIERA CARDANO (4 in linea e V6) (-1995)	CROISILLON CARDAN (4 en ligne et V6) (-1995)
36	REC393831	393831	CARDAN	CARDAN	CARDAN	CARDAN
37	REC59830A7	59830A7	UNIÓN COLA - MOTOR	UNION DRIVE SHAFT - ENGINE	ASSE CARDANO PIEDE MOTORE	CARDAN EMBASE
38	REC25-25439	25-25439	ARO TORICO	O-RING	O-RING	JOINT TORIQUE
	REC25-35027	25-35027	ARO TÓRICO	O-RING	O-RING	JOINT TORIQUE
39	REC814819A2	814819A2	KIT TRANSMISIÓN (1991-97)	TRANSMISSION KIT (1991-97)	KIT TRASMISSIONE (1991-97)	ARBRE TRANSMISSION (1991-97)
	REC864281A2	864281A2	KIT TRANSMISIÓN (1998+)	TRANSMISSION KIT (1998+)	KIT TRASMISSIONE (1998+)	ARBRE TRANSMISSION (1998+)
40	REC26-88397A1	26-88397A1	KIT RETENES	GEARCASE SEAL KIT	KIT PARAOILIO	KIT JOINTS
41	REC27-94996Q2	27-94996Q2	KIT RETENES	GEARCASE SEAL KIT	KIT PARAOILIO	KIT JOINTS
	RECKITMALPHA2AL		KIT ÁNODOS AL	ANODE KIT AL	KIT ANODI AL	KIT ANODES AL
42	CMALPHAKITA		KIT ÁNODOS AL	ANODE KIT AL	KIT ANODI AL	KIT ANODES AL
	CMALPHAKITM		KIT ÁNODOS MG	ANODE KIT MG	KIT ANODI MG	KIT ANODES MG
	TENKITALPHAONE/2		KIT ÁNODOS ZN	ANODE KIT ZN	KIT ANODI ZN	KIT ANODES ZN
43	REC43-18411A2	43-18411A4	KIT PIÑONES Y COJINETE Reforzados 20/22 (Red. 1.50) Para V8.	DRIVE SHAFT HOUSING GEAR SET Heavy duty 20/22 (ratio 1.50) for V8	KIT PIGNONI E CUSCINETTI RINFORZATI 20/22 Denti (Rid. 1.50) Per V8	KIT PIGNONS ET ROULEMENTS Renforcé 20/22 (Réd. 1.50) Pour V8.

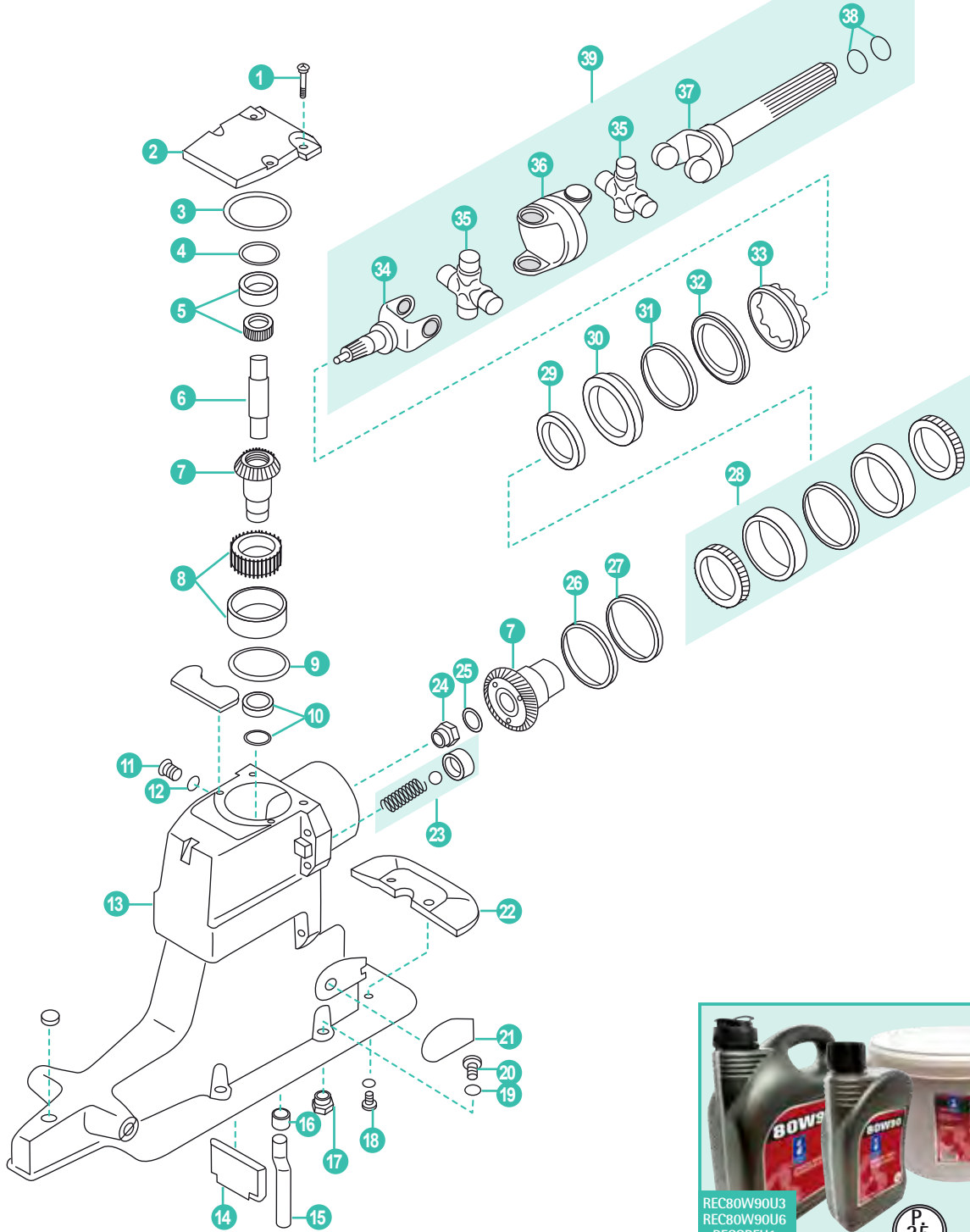

	REF	OEM				
1	REC10-98794	10-98794	TORNILLO	SCREW	VITE	VIS
2	REC828692A1	828692A1	TAPA SUPERIOR	COVER ASSEMBLY	COPERCHIO	COUVERCLE
3	REC25-32546	25-32546	ARO	O-RING	ANELLO	BAGUE
4	REC15-32563A1	15-32563A1	SUPLEMENTO (Cojinete 21511)	SHIM (FOR 21511 bearing)	ESPESTORE (cuscinetto 21511)	CALE (roulement 21511)
5	REC31-32575T1	31-32575T1	COJINETE (O.D. 1-25/32)	BEARING ASSY (O.D. 1-25/32)	CUSCINETTO (O.D. 1-25/32)	ROULEMENT (O.D. 1-25/32)
6	REC45-557961	45-557961	EJE	DRIVE SHAFT	ASSE	ARBRE
	REC43-853641A2	43-853641A2	KIT PIÑONES (Red. 1.47) (20-22)	GEAR SET (1.47 RATIO) (20-22)	KIT PIGNONE (Rid. 1.47) (20-22)	KIT PIGNON (Réd. 1.47) (20-22)
7	REC43-853640A2	43-853640A2	KIT PINONES (Red. 2.00/1.62) (24-24)	GEAR SET (2.00/1.62 RATIO) (24-24)	KIT PIGNONE (Rid. 2.00/1.62) (24-24)	KIT PIGNON (Réd. 2.00/1-62) (24-24)
	REC43-853643A2	43-853643A2	KIT PINONES (Red. 1.81) (17-19)	GEAR SET (1.81 RATIO) (17-19)	KIT PIGNONE (Rid. 1.81) (17-19)	KIT PIGNON (Réd. 1.81) (17-19)
	REC43-853642A2	43-853642A2	KIT PINONES (Red. 2.40/1.94) (20-24)	GEAR SET (2.40/1.94 RATIO) (20-24)	KIT PIGNONE (Rid. 2.40/1.94) (20-24)	KIT PIGNON (Réd. 2.40/1.94) (20-24)
8	REC31-35990A1	31-35990A1	COJINETE (Red. 1.62, 1.81, 1.94, 2.00, 2.40)	ROLLER BEARING (1.62, 1.81, 1.94, 2.00, 2.40 RATIO)	CUSCINETTO (Rid. 1.62, 1.81, 1.94, 2.00, 2.40)	KIT PIGNON (Réd. 1.61, 1.81, 1.94, 2.00, 2.40)
	REC31-32573A1	31-32573A1	COJINETE (Red. 1.47)	ROLLER BEARING (1.47 RATIO)	CUSCINETTO (Rid. 1.47)	ROULEMENT (Réd. 1.47)
9	REC15-36178A02	15-36178A02	SUPLEMENTO	SHIM	SPESTORE	CALE
10	REC26-66302	26-66302	RETÉN (-OM400411)	OIL SEAL (-OM400411)	PARAOLIO (-OM400411)	JOINT D'HUILE (-OM400411)
	REC26-864319	26-864319	RETÉN (OM400412+)	OIL SEAL (OM400412+)	PARAOLIO (OM400412+)	JOINT D'HUILE (OM400412+)
11	REC10-79953Q04	10-79953Q04	KIT TORNILLOS	SCREW KIT	KIT VITE	KIT VIS
12	REC12-191833	12-191833	ARANDELA	WASHER	RONDELLA	RONDELLA
13	REC1547-815930A7	1547-815930A7	CARCASA	HOUSING	CARCASSA	CARDAN
14	RM815932	815932	SEPARADOR ESCAPE	FILLER WALL	SEPARATORE	CALE ÉCHAPPEMENT
15	REC32-860220	32-860220	TUBO GUÍA	GUIDE TUBE	TUBO GUIDA	TUBO GUIDE
16	REC26-88397	26-88397	GRUESO	GROMMET	SPESTORE	CALE
17	REC11-859135	11-859135	TUERCA	LOCKNUT	DADO	ÉCROU
18	REC10-28668	10-28668	TORNILLO	SCREW	VITE	VIS
19	REC12-45176	12-35935	ARANDELA	WASHER	RONDELLA	RONDELLE
20	REC10-816601	10-816601	TORNILLO	BOLT	VITE	VIS
21	REC8M2015937	8M2015937	GRUESO BABOR	WEAR PAD - PORT	SPESTORE BABORDO	CALE BABORD
	REC8M2015938	8M2015938	GRUESO ESTRIBOR	WEAR PAD - STARBOARD	SPESTORE TRIBORDO	CALE TRIBORD
22	CM821629	821629Q1	ANODO ZN	ZN ANODE	ANODO ZN	ANODE ZN
	CM821629A	821629Q1	ANODO AL	AL ANODE	ANODO AL	ANODE AL
23	REC24-17997A1	24-17997A1	KIT BOLA ENGRASE	SPRINT KIT	KIT BOLA INGRASSATORE	VALVE BY-PASS
24	REC11-22339	11-22339	TUERCA	NUT	DADO	ÉCROU
25	REC12-45810	12-45810	ARANDELA	WASHER	RONDELLA	RONDELLE
26	REC15-71013	15-71013	ESPACIADOR	SPACER	DISTANZIALE	CALE
27	REC15-35980A1	15-35980A1	SUPLEMENTO	SHIM	SPESTORE	SUPPLEMENT
28	RM31-30894A5	31-30894A5	KIT COJINETE	BEARING KIT	KIT CUSCINETTO	KIT ROULEMENT
29	REC26-823894	26-823894	RETÉN ACEITE	OIL SEAL	PARAOLIO	JOINT D'HUILE
30	REC66081A2	66081A2	CUERPO RETÉN CARDAN	HOUSING CARDAN SEAL	PARAOLIO CARDANO	CORPS JOINT DU CARDAN
31	REC25-70937	25-70937	ARO TÓRICO	O-RING	O-RING	JOINT TORIQUE
32	REC35983	35983	ARO	O-RING	O-RING	JOINT TORIQUE
33	REC8168112	8168112	RETENEDOR	RETAINER	TENUTA	JOINT D'HUILE
34	REC853635	853635	UNIÓN COLA CARDÁN (-OM400411)	YOKE (-OM400411)	UNIONE PIEDE -CARDAN (-OM400411)	CARDAN (-OM400411)
	REC864282T	864282T	UNIÓN COLA CARDÁN (OM4004112+)	YOKE (OM4004112+)	UNIONE PIEDE - CARDAN (OM400412+)	CARDAN (OM400412+)
35	REC805536A2	805536A2	CRUCETA CARDAN (-OM400411)	U-JOINT (-OM400411)	CROCETTA (-OM400411)	CROISILLON CARDAN (-OM400411)
	REC865496A02	865496A02	CRUCETA CARDAN (OM400412+)	U-JOINT (OM400412+)	CROCETTA (OM400412+)	CROISILLON CARDAN (OM400412+)
36	REC393831	393831	CARDAN (-OM400411)	SOCKET (-OM400411)	CARDAN (-OM400411)	CARDAN (-OM400411)
	REC865503T	865503T	CARDAN (OM400412+)	SOCKET FROM (OM4004112+) (GKN)	CARDAN (OM400412+)	CARDAN (OM400412+)
37	REC59830A7	59830A7	UNIÓN COLA (-OM400411)	YOKE ASSY. (-OM400411)	UNIONE PIEDE (-OM400411)	CARDAN (-OM400411)
	REC864281A2	865491A01 864281A01	UNIÓN COLA (OM400412+)	YOKE ASSY. (OM400412+) (GKN)	UNIONE PIEDE (OM400412+)	CARDAN (OM400412+)
38	REC25-25439	25-25439	ARO	O-RING	ANELLO	JOINT TORIQUE
	REC25-35027	25-35027	ARO	O-RING	ANELLO	JOINT TORIQUE
39	REC814819A7	814819A7	KIT TRANSMISIÓN (Gris)	U-JOINT ASSEMBLY (Grey)	KIT TRASMISSIONE (Grigio)	ARBRE TRANSMISSION (jaune)
	REC864281A2	86481A2	KIT TRANSMISIÓN GKN (Negro) (OL100009+)	U-JOINT ASSEMBLY GKN (BLACK) (OL100009+)	KIT TRASMISSIONE GKN (NERO) (OL100009+)	ARBRE TRANSMISSION (noir) (OL100009+)
40	REC26-88397A1	26-88397A1	KIT RETENES	GEARCASE SEAL KIT	KIT PARAOLIO	KIT JOINTS
41	REC27-94996Q2	27-94996Q2	KIT RETENES	GEARCASE SEAL KIT	KIT PARAOLIO	KIT JOINTS
	RECKITMALPHA2AL		KIT ÁNODOS AL	ANODE KIT AL	KIT ANODI AL	KIT ANODES AL
42	CMALPHAKITA		KIT ÁNODOS AL	ANODE KIT AL	KIT ANODI AL	KIT ANODES AL
	CMALPHAKITM		KIT ÁNODOS MG	ANODE KIT MG	KIT ANODI MG	KIT ANODES MG
	TENKITALPHAONE/2		KIT ÁNODOS ZN	ANODE KIT ZN	KIT ANODI ZN	KIT ANODES ZN
43	REC864281A2	864281A2	KIT TRANSMISION GNK (negro)	YOKE ASSEMBLY GNK (black)	GIUNTO CARDANICO GNK (nero)	CARDAN COMPLET (noir)

ALPHA ONE GEN II STD & COUNTER ROTATION

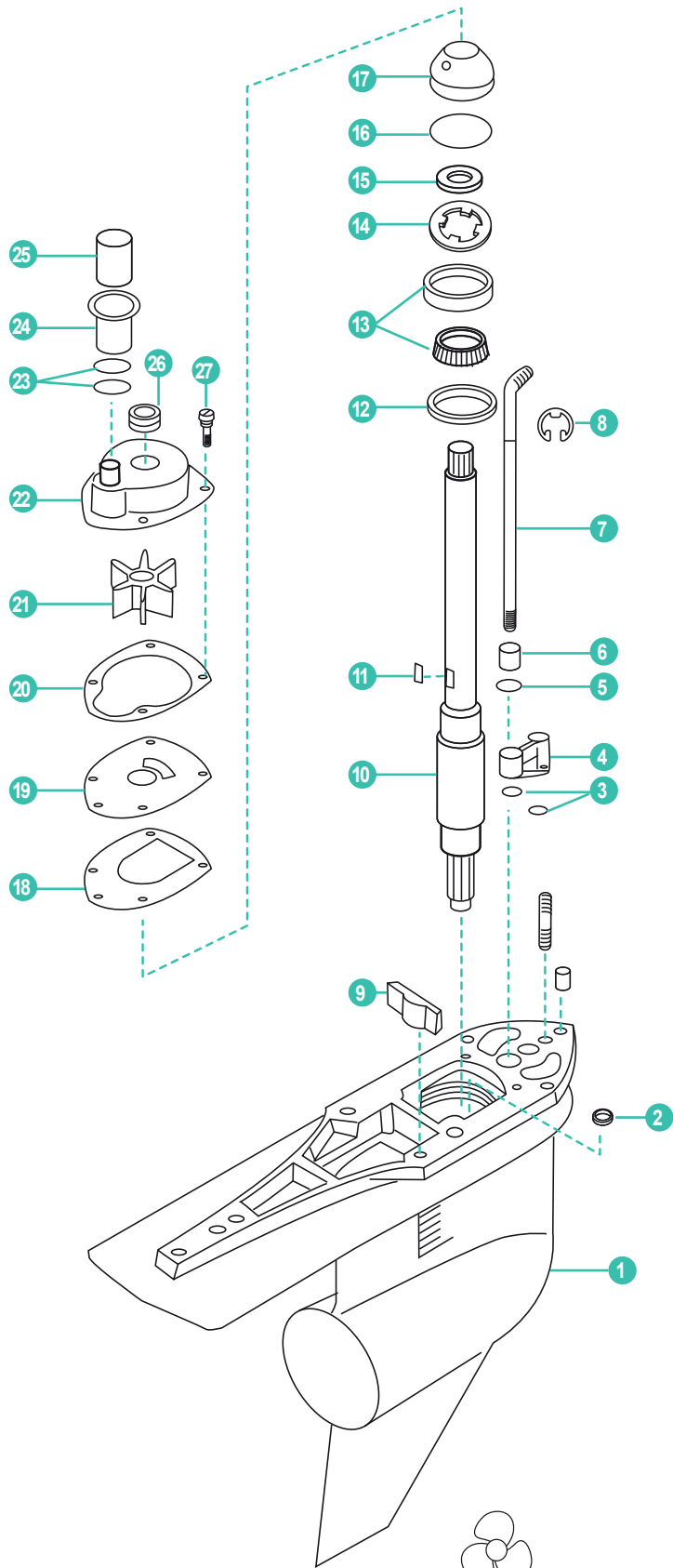

	REF	OEM				
1	REC1623-815822A30	1623-815822A30	CARCASA COLA (OD469859-999999)	HOUSING (OD469859-999999)	CARCASSA (OD469859-999999)	CARDAN (OD469859-999999)
2	REC26-455771	26-45577-1	RETÉN	SEAL	TENUTA	JOINT D'HUILE
3	REC25-36318	25-36318	ARO TÓRICO	O-RING	ANELLO	JOINT TORIQUE
4	REC23-815921A21	23-815921A21	CASQUILLO	SHIFT BUSHING	BOCCOLA	INSERT D'AXE
5	REC26-8164641	26-816464-1	RETÉN ACEITE	OIL SEAL	PARAOLIO	JOINT D'HUILE
6	REC23-67370	23-67370	LEVA	CAM	BOCCOLA	CAM
7	REC815919A1	815919A1	EJE CAMBIO	DRIVE SHAFT	ASSE	ARBRE CHANGEMENT
8	REC53-29641	53-29641	CIERRE	CIRCLIP	CIRCLIP	CLIPS
9	REC821526001	861526001	RETÉN DE GOMA	RUBBER SEAL	PARAOLIO IN GOMMA	JOINT CAOUTCHOUC
10	REC45-816919	45-816919	EJE TRANSMISIÓN (-999999)	SHAFT (-999999)	ASSE (-999999)	ARBRE TRANSMISSION (-999999)
	REC45-853648	45-853648	EJE TRANSMISIÓN (OL100040+)	SHAFT (OL100040+)	ASSE (OL100040+)	ARBRE TRANSMISSION (OL100040+)
11	REC28-8M0032833	28-8M0032833	CHAVETA	CLIP	CHIAVE	CLAVETTE
12	REC15-42637A1	15-42637A1	GRUESO	SHIM	SPESSORE	CALE
13	REC31-36387A1	31-36387A1	RODAMIENTO	BEARING	CUSCINETTO	ROULEMENT
	REC31-33138A1	31-33138A1	RODAMIENTO (1998+)	BEARING (1998+)	CUSCINETTO (1998+)	ROULEMENT (1998+)
14	REC8245191	8245191	RETENEDOR	SEAL	TENUTA	JOINT D'HUILE
15	REC26-66302	26-66302	RETÉN ACEITE (-0M400411)	OIL SEAL (-0M400411)	PARAOLIO (-0M400411)	JOINT D'HUILE (-0M400411)
	REC26-864319	26-864319	RETÉN ACEITE (0M400411+)	OIL SEAL (0M400411+)	PARAOLIO (0M400411+)	JOINT D'HUILE (0M400411+)
16	REC25-90011	25-90011	ARO TÓRICO	O-RING	ANELLO	JOINT TORIQUE
17	REC807929A1	807929A1	PORTA RETÉN (1991+)	SEAL BASE (1991+)	BASE TENUTA (1991+)	BASE DE POMPE A EAU (1991+)
18	REC27-430331	27-430331	JUNTA	GASKEET	GUARNIZIONE	JOINT
19	REC8172761	8172761	TAPA BOMBA AGUA	PUMP CAP	COPERCHIO POMPA	COUVERCLE POMPE
20	REC27-8172771	27-8172771	JUNTA	GASKET	GUARNIZIONE	JOINT
21	REC47-43026Q02	47-43026Q02	IMPULSOR	IMPELLER	GIRANTE	TURBINE
22	RM817275A1	817275A1	TAPA BOMBA AGUA	CAP WATER PUMP	COPERCHIO POMPA ACQUA	COUVERCLE POMPE
23	REC25-21836	25-21836	ARO TÓRICO	O-RING	FASCE	JOINT TORIQUE
24	REC816597A1	816597A1	TUBO AGUA	TUBE	TUBO	DURITE À EAU
25	REC23-816583	23-816583	TUBO	TUBE	TUBO	TUYAU
26	REC26-816575A2	26-816575A2	RETÉN GOMA	SEAL	TENUTA	JOINT CAOUTCHOUC
27	REC10-816928	10-816928	TORNILLO	BOLT	VITE	VIS
28	REC26-816575A3	26-816575A3	KIT REPARACIÓN	REPAIR KIT	KIT RIPARAZIONE	KIT JOINT
29	RM23-815921A17	23-815921A17	CASQUILLO CORREDERA	BUSHING	GHIERA SCORREVOLE	BUSHING



ALPHA ONE GEN II STD & COUNTER ROTATION

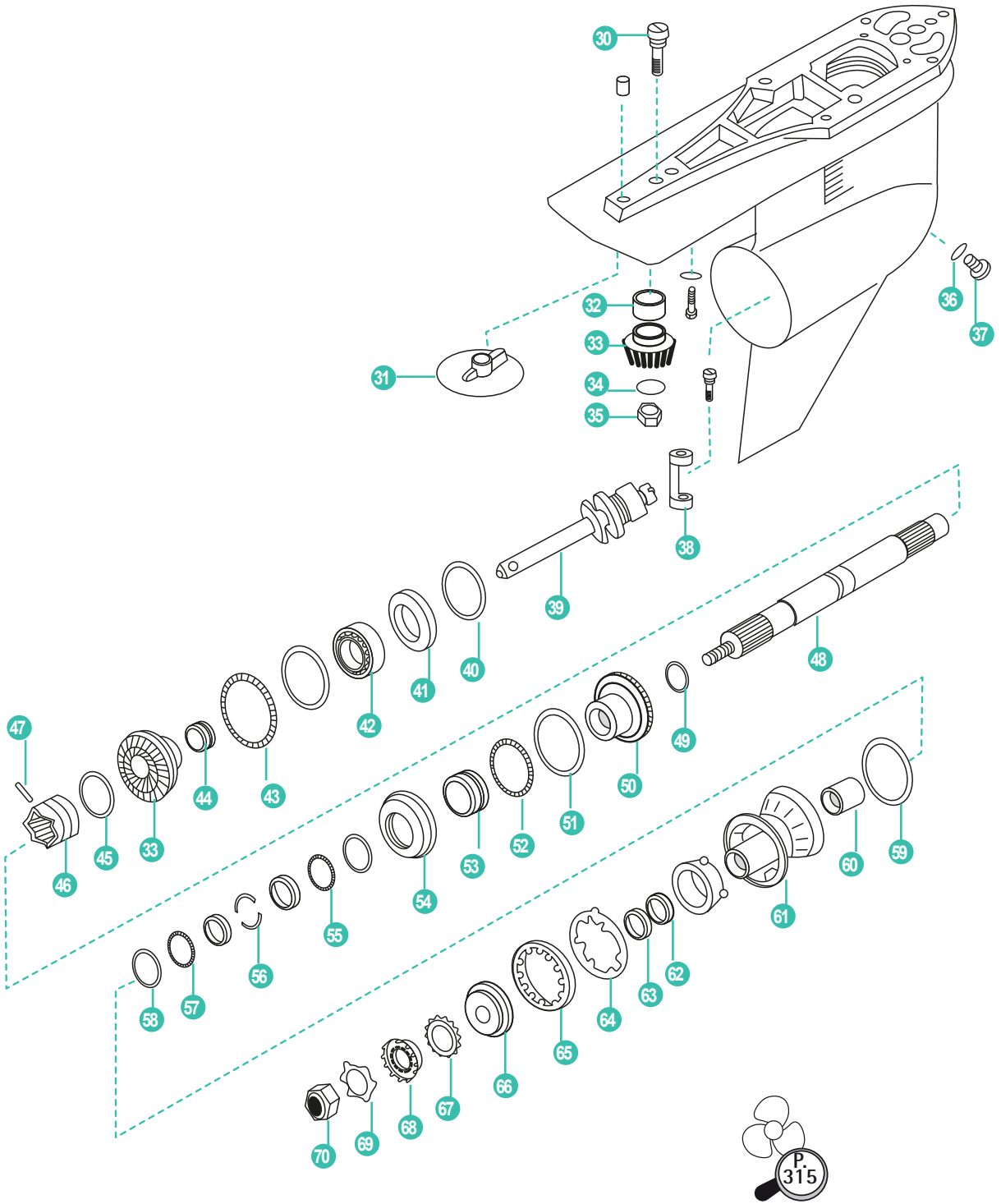

	REF	OEM				
30	REC10-806327	10-806327	TORNILLO	BOLT	VITE	VIS
31	CM762145	76214Q5	ÁNODO ZN	ANODE ZN	ANODO ZN	ANODE ZN
	CM762145A	76214Q5	ÁNODO AL	ANODE ALU	ANODO AL	ANODE AL
32	REC387817	31-42647A1	RODAMIENTO	BEARING	CUSCINETTO	ROULEMENT
33	REC43-878087A2	43-878087A2	KIT PIÑONES (1996+) 13:21 1.47, 1.62, 1.81, 1.94 Ratio 3.265 OD Avante	PINION SET(1996) 13:21 1.47, 1.62, 1.81, 1.94 Ratio 3.265 OD Forward bearing	KIT PIGNONE (1996) 13:21 1.47, 1.62, 1.81, 1.94 Rapporto 3.265 OD Avanti	KIT PIGNON (1996) 13:21 1.47, 1.62, 1.81, 1.94 Réd. 3.265 OD avant
	REC43-878617A2	43-853592A2	KIT PIÑONES (1998+) 2.00:1 / 2.40:1 3.265 OD Avante	PINION SET (1998+) 2.00:1 / 2.40:1 3.265 OD Forward bearing	KIT PIGNONE (1998+) 2.00:1 / 2.40:1 3.265 OD Avanti	KIT PIGNON (1998+) 2.00:1 / 2.40:1 3.265 OD avant
34	REC350038	12-92721	JUNTA	GASKET	GUARNIZIONE	JOINT
35	REC11-35921	11-35921	TUERCA	NUT	DADO	ÉCROU
36	REC12-191833	12-191833	JUNTA TAPÓN	CAP GASKET	GUARNIZIONE TAPPO	JOINT BOUCHON
37	REC22-67892A05	8M0058389	TAPÓN	CAP	TAPPO	BOUCHON
38	REC76865	76865	HORQUILLA CAMBIO	CLIP	CLIP	FOURCHETTE
39	REC818349T1	818349T1	EJE DESPLAZABLE	SHAFT	ASSE	SELECTEUR D'INVERSEUR
40	REC15-47397A1	15-47397A1	GRUESO (1991-95)	SHIM (1991-95)	SPESSORE (1991-95)	CALE (199-95)
	REC15-44491A1	15-44491A1	GRUESO (1996+)	SHIM (1996+)	SPESSORE (1996+)	CALE (1996+)
41	REC31-828437A2	31-828437A2	COJINETE Ø 44,45-88,9 mm	BEARING Ø 44,45-88,9 mm	CUSCINETTO Ø44,45-88,9 mm	ROULEMENT Ø44,45-88,9 mm
	REC31-35928T1	31-35928T1	COJINETE Ø 47,62-88,9 mm	BEARING Ø 47,62-88,9 mm	CUSCINETTO Ø 47,62-88,9 mm	ROULEMENT Ø 47,62-88,9 mm
42	REC31-30894A1	31-30894A1	COJINETE Ø 44,45-82,93 mm	BEARING Ø 44,45-82,93 mm	CUSCINETTO Ø 44,45-82,93 mm	ROULEMENT Ø 44,45-82,93 mm
	REC31-828439A2	31-828439A2	COJINETE Ø 47,62-82,93 mm	BEARING Ø 47,62-82,93 mm	CUSCINETTO Ø 47,62-82,93 mm	ROULEMENT Ø 47,62-82,93 mm
	REC828830A2	828830A2	COJINETE ADAPTADOR	BEARING ADAPTOR ASSY	CUSCINETTO ADATTATORE	ADAPTATEUR POUR ROULEMENT
42	REC31-814653T	31-814653	COJINETE	BEARING CARRIER	CUSCINETTO	ROULEMENT
43		31-815480	COJINETE ALPHA (1996+)	BEARING ALPHA (1996+)	CUSCINETTO ALPHA (1996+)	ROULEMENT ALPHA (1996+)
44	REC31-30895T	31-30895T	RODAMIENTO STD	BEARING STD	CUSCINETTO STD	ROULEMENT STD
	REC31-15844	31-15844	RODAMIENTO	BEARING	CUSCINETTO	ROULEMENT
45	REC24-30893	24-30893	MUELLE	SPRING	MOLLA	RESSORT
46	REC52-853594T	52-853594T	SELECTOR	GEAR	PIGNONE	CRABOT
47	REC17-8M0084681	8M0020941	PASADOR	PIN	SPINOTTO	GOUPILLE
	REC44-824110	44-824110	EJE HÉLICE (1991-97) (-999999)	SHAFT PROPELLER (1991-97) (-999999)	ASSE ELICA (1991-97) (-999999)	ARBRE HÉLICE (91-97) (-999999)
48	REC44-850308	44-850308	EJE HÉLICE (1998+) (OL100040+)	SHAFT PROPELLER (1998+) (OL100040+)	ASSE ELICA (1991-97) (OL100040+)	ARBRE HÉLICE (1991-97) (OL100040+)
	REC44-8146061	814606 1	EJE (1991-95)	PROPSHAFT (1991-95)	ASSE (1991-95)	ARBRE (1991-95)
49	REC23-824108	23-824108	SUPLEMENTO	SHIM	SPESSORE	CALE
50	REC43-828073A1	43-828073A1	PIÑÓN MARCHA ATRÁS	GEAR REVERSE	PIGNONE MARCIA INDIETRO	PIGNON MARCHE ARRIÈRE
51	REC681001	681001	ARO	RING	ANELLO	BAGUE
52	REC30-88957T	30-88957T1	RODAMIENTO	BEARING	CUSCINETTO	ROULEMENT
53	REC31-814653T	31-814653	ARANDELA	WASHER	RONDELLA	RONDELLE
54	REC814604T1	814604A1	RODAMIENTO	BEARING	CUSCINETTO	ROULEMENT
55	REC31-15842	31-15842	COJINETE RODILLOS	NEEDLE BEARING	CUSCINETTO	ROULEMENT
56	REC814605	814605	CIERRE	KEEPERS PROPSHAFT	CHIUSURA	CLIP
57	REC31-15842	31-15842	COJINETE RODILLOS	NEEDLE BEARING	CUSCINETTO	ROULEMENT
58	REC12-18448	12-18448	ARANDELA CIERRE	WASHER CLOSURE	RONDELLA CHIUSURA	RONDELLA
59	REC25-31534	25-31534	ARO TÓRICO	O-RING	FASCE	JOINT TORIQUE
60	REC387247	31-30956T	RODAMIENTO	BEARING	CUSCINETTO	ROULEMENT
61	REC818763A10	818763A10	COJINETE COLA STD	BEARING STD	CUSCINETTO STD	ROULEMENT
	REC14587A7	14587A5	COJINETE (1991-95)	BEARING CARRIER (1991-95)	CUSCINETTO(1991-95)	ROULEMENT (1991-95)
62	REC26-76868	26-14077	RETÉN ACEITE Interior	OIL SEAL Inside	PARAOLIO interno	JOINT D'HUILE intérieur
63	REC26-12224	26-12224	RETÉN ACEITE Extrior	OIL SEAL Outside	PARAOLIO esterno	JOINT D'HUILE extérieur
64	REC14-18323	14-18323	TAPA	CAP	COPERCHIO	COUVERCLE
65	REC8M2011027	8M2011027	TUERCA	NUT	DADO	ÉCROU
66	REC12-835467Q01	12-835467Q01	SEPARADOR	SPACER	DISTANZIALE	CALE
67	REC13-423511	13-423511	CIERRE	CLIP	CHIUSURA	CLIPS
68	REC12-31211Q03	12-31211A2	TOPE CIERRE HÉLICE	END CLIP	TAPPO CHIUSURA ELICA	RONDELLE FREIN DE DIABOLO
69	REC90508-ZW1-003	14-816629Q	CIERRE	CLIP	CHIUSURA	RONDELLE FREIN
70	REC90301-ZW1-003	11-827614	TUERCA	NUT	DADO	ÉCROU
71	REC11-52707Q1	11-52707Q1	KIT CIERRE HÉLICE	PROPELLER NUT KIT	KIT CHIUSURA ELICA	KIT ÉCROU D'HÉLICE
	RECKITMALPHA2AL		KIT ÁNODOS AL	ANODE KIT AL	KIT ANODI AL	KIT ANODES AL
72	CMALPHA2AL		KIT ÁNODOS AL	ANODE KIT AL	KIT ANODI AL	KIT ANODES AL
	CMALPHA2MG		KIT ÁNODOS MG	ANODE KIT MG	KIT ANODI MG	KIT ANODES MG
	TENKITALPHAONE/2		KIT ÁNODOS ZN	ANODE KIT ZN	KIT ANODI ZN	KIT ANODES ZN
73	CM806105	806105Q1	ÁNODO EJE HÉLICE ZN	PROP SHAFT ANODE ZN	ANODO ASSE ELICA ZN	ANODE ARBRE HÉLICE ZN
	CM806105A	806105Q1	ÁNODO EJE HÉLICE AL	PROP SHAFT ANODE AL	ANODO ASSE ELICA AL	ANODE ARBRE HÉLICE AL
74	REC43-878087A2	43-878087A2	KIT PIÑÓN RODAMIENTO (13:21) INCLUYE RODAMIENTO REC31-30894A1 (1996+)	PINION AND FORWARD GEAR SET. INCLUDES FORWARD BEARING REC31-30894A1 (1996+)	KIT PIGNONI (13:21) INCLUE CUSCINETTO REC31-30894A1 (1996+)	KIT PIGNONE ROULEMENT (13:21) COMPRIS LE ROULEMENT REC31-3089A1 (1996+)



CONTRAROTACIÓN
ROTACIÓN ESTÁNDAR

COUNTER ROTATION
STD ROTATION

CONTOROTRANTE
ROTAZIONE STD

CONTRAROTATION
ROTATION STD

BRAVO

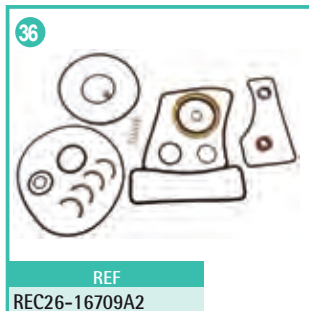
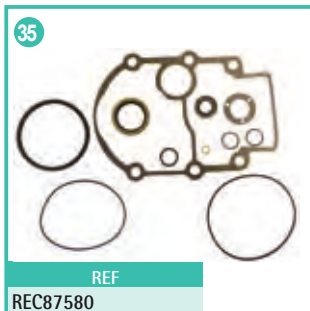
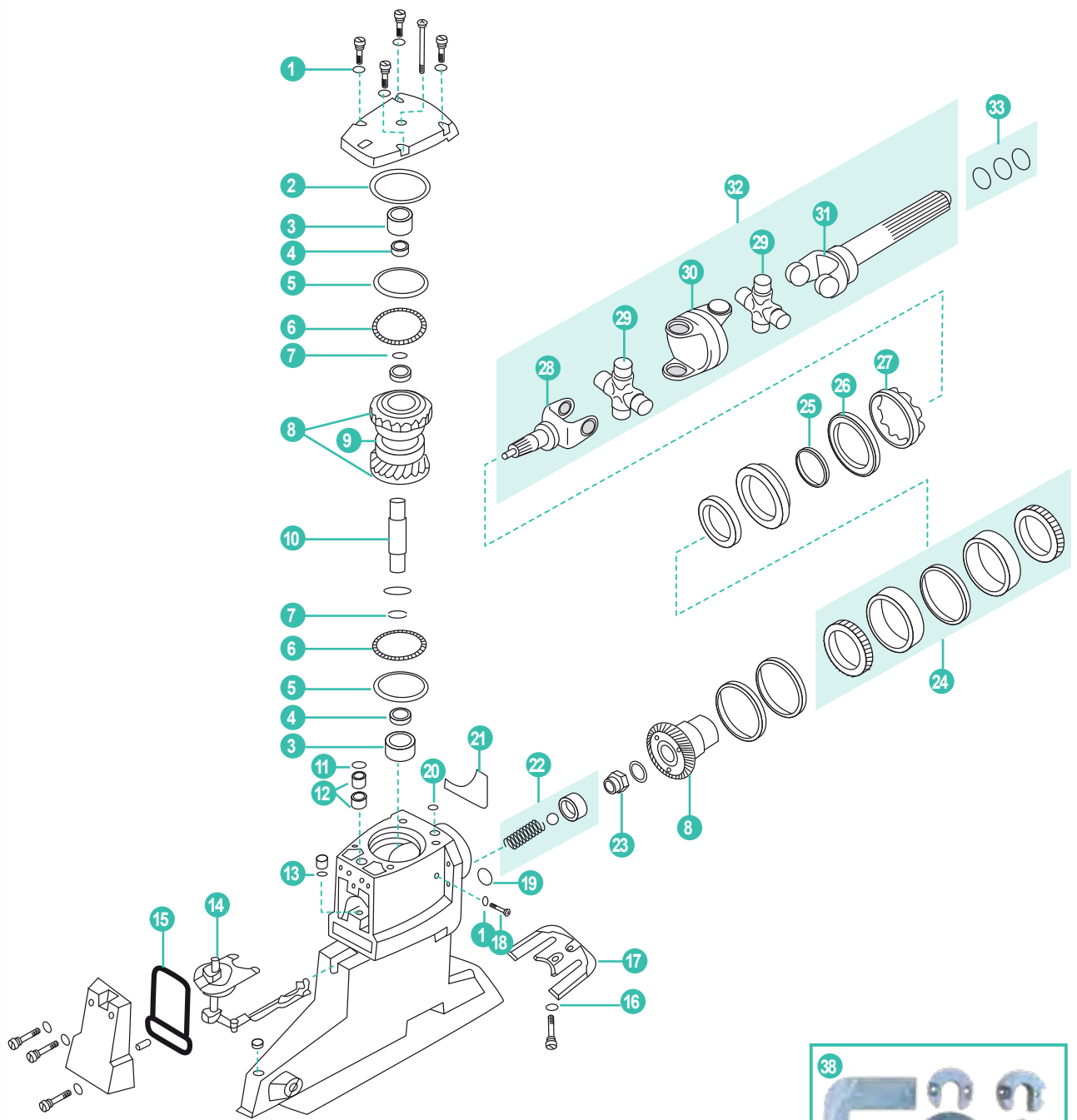

	REF	OEM				
1	REC12-191833	12-191833	JUNTA	GASKET	GUARNIZIONE	JOINT
2	REC25-97387	25-97387	ARO TÓRICO	O-RING	ANELLO	JOINT TORIQUE
3	REC31-815900	31-815900	COJINETE	BEARING	CUSCINETTO	ROULEMENT
4	REC31-87156	31-87156	COJINETE	BEARING	CUSCINETTO	ROULEMENT
	RM23-87560091	23-87560091	GRUESO .091 rojo	SHIM .091 red	SPESSORE .091 rosso	CALE .091 rouge
5	RM23-87560094	23-87560094	GRUESO .094 azul	SHIM .094 blue	SPESSORE .094 blu	CALE .094 bleu
	RM23-87560097	23-87560097	GRUESO .097 verd	SHIM .097 green	SPESSORE .097 verde	CALE .097 verd
6	REC31-86771	31-86771	COJINETE	BEARING	CUSCINETTO	ROULEMENT
7	RM97351	97351	RETENEDOR	RETAINER	TENUTA	JOINT D'HUILE
	RM43-887906A1	43-887906A1	KIT PIÑONES (29/27) BRAVO I. 1.36:1 BRAVO II. 1.50:1 & 1.81:1 BRAVO III. 1.36:1 & 1.81:1 KIT PINONES (32/27)	BEARING KIT (29/27) BRAVO I. 1.36:1 BRAVO II. 1.50:1 & 1.81:1 BRAVO III. 1.36:1 & 1.81:1 BEARING KIT (32/27)	KIT PIGNONE (29/27) BRAVO I. 1.36:1 BRAVO II. 1.50:1 & 1.81:1 BRAVO III. 1.36:1 & 1.81:1 KIT PIGNONE (32/27)	KIT PIGNONE (29/27) BRAVO I. 1.36:1 BRAVO II. 1.50:1 & 1.81:1 BRAVO III. 1.36:1 & 1.81:1 KIT PIGNONE (32/27)
8	RM43-887903A1	43-887903A1	BRAVO I. 1.50:1 BRAVO II. 1.65:1 & 2.00:1 BRAVO III. 1.65:1 & 2.00:1 KIT PINONES (30/23)	BRAVO I. 1.50:1 BRAVO II. 1.65:1 & 2.00:1 BRAVO III. 1.65:1 & 2.00:1 BEARING KIT (30/23)	BRAVO I. 1.50:1 BRAVO II. 1.65:1 & 2.00:1 BRAVO III. 1.65:1 & 2.00:1 KIT PIGNONE (30/23)	BRAVO I. 1.50:1 BRAVO II. 1.65:1 & 2.00:1 BRAVO III. 1.65:1 & 2.00:1 KIT PIGNONE (30/23)
	RM43-887909A1	43-887909A1	BRAVO I. 1.65:1 BRAVO II. 2.20:1 BRAVO III. 2.20:1 & 2.43:1	BRAVO I. 1.65:1 BRAVO II. 2.20:1 BRAVO III. 2.20:1 & 2.43:1	BRAVO I. 1.65:1 BRAVO II. 2.20:1 BRAVO III. 2.20:1 & 2.43:1	BRAVO I. 1.65:1 BRAVO II. 2.20:1 BRAVO III. 2.20:1 & 2.43:1
9	RM52-865344A01	52-865344A01	CURSOS	CLUTCH	CURSORE	CONE D'EMBRAYAGE
10	RM45-812773T	45-812773	EJE TRANSMISIÓN	DRIVE SHAFT	ASSE	ARBRE TRANSMISSION
11	REC25-62705	25-62705	ARO TÓRICO	O-RING	ANELLO	JOINT TORIQUE
12	REC23-861209A1	23-861209A1	RETÉN	RETAINER	TENUTA	JOINT D'HUILE
13	REC26-12709	26-12709	RETÉN ACEITE	OIL SEAL	PARAOLIO	JOINT D'HUILE
14	REC12711	12711	EJE SELECTOR	SHAFT	ASSE SELETTORE	ARBRE SUPERIEUR
15	REC12708	12708	RETÉN	RETAINER	TENUTA	JOINT
16	REC13-35048	13-35048	ARANDELA	WASHER	RONDELLA	RONDELLE
17	CM821630	821630Q1	ÁNODO ZN	ANODE ZN	ANODO ZN	ANODE ZN
	CM821630A	821630Q1	ÁNODO AL	ANODE AL	ANODO AL	ANODE AL
18	REC22-67892A05	8M0058389	TORNILLO	SCREW	VITE	VIS
19	REC25-457101	25-457101	ARO TÓRICO (1.424 x 103)	O-RING (1.424 x 103)	ANELLO (1.424 x 103)	JOINT TORIQUE (1.424 x 103)
20	REC25-62706	25-62706	ARO TÓRICO (.426 x 0.70)	O-RING (.426 x 0.70)	ANELLO (.426 x 0.70)	JOINT TORIQUE (.426 x 0.70)
21	REC86310	16755Q1	RETÉN	RETAINER	TENUTA	JOINT D'HUILE
22	REC24-17997A1	24-17997A1	JUEGO MUELLE	SPRING SET	KIT MOLLA	KIT RESSORT
23	REC11-22339	11-22339	TUERCA	NUT	DADO	ÉCROU
24	REC31-86763A2	31-86763A2	RODAMIENTO (- OM198372)	BEARING (-OM198372)	CUSCINETTO (-OM198372)	ROULEMENT (-OM198372)
	RM31-86763A04	31-86763A04	RODAMIENTO (OM198373+)	BEARING (OM198373+)	CUSCINETTO (-OM198373+)	ROULEMENT (-OM198373+)
25	REC26-807006	26-807006	RETÉN ACEITE Ø 2.254"	OIL SEAL Ø 2.254"	PARAOLIO Ø 2.254"	OINT D'HUILE Ø 2.254"
	REC26-43993	26-43993	RETÉN ACEITE Ø 2.132"	OIL SEAL Ø 2.132"	PARAOLIO Ø 2.132"	OINT D'HUILE Ø 2.132"
26	REC86779A1	86779A1	PORTA RETÉN	RING	ANELLO	BAGUE PORTE JOINT SPI
27	RM11-92004	11-92004	TUERCA	NUT	DADO	ÉCROU
28	REC12784	12784	UNIÓN COLA-CARDAN (OM111207-)	YOKE (OM111207-)	ASSE PIEDE-CARDANO (OM111207-)	CARDAN (OM111207-)
	REC3850812	75832	CRUCETA	U-JOINT	CROCETTA	CROISILLON POUR EMBASE
29	RM866136A01	866136A01	CRUCETA (OM750175+) GKN	U-JOINT (OM750175+) GKN	CROCETTA (OM750175+) GKN	CROISILLON (OM750175+) GKN
	REC862132T	862132T	CRUCETA BRAVO X, XR, XZ	U-JOINT BRAVO X, XR, XZ	CROCETTA BRAVO X, XR, XZ	CROISILLON BRAVO X, XR, XZ
	REC865496A02	865496A01	CRUCETA BRAVO (OM111208+)	U-JOINT BRAVO (OM111208+)	CROCETTA BRAVO (OM111208+)	CROISILLON BRAVO (OM111208+)
30	REC393831	393831	CARDÁN (-OM111207)	SOCKET (-OM111207)	CARDANO (-OM111207)	CARDAN (-OM111207)
31	REC59830A7	814819A3	UNIÓN COLA MOTOR	YOKE ASSY	ASSE PIEDE	CARDAN
32	REC864244A2	864244A2	KIT TRANSMISIÓN BRAVO (OB664190+) (1985-05)	U-JOINT ASSEMBLY BRAVO (OB664190+) (1985-05)	KIT TRASMISSIONE BRAVO (OB664190+) (1985-05)	KIT TRASMISSION BRAVO (OB664190+) (1985-05)
	RM865425A03	865425A03	KIT TRANSMISIÓN COLAS BRAVO X, XR, XZ	U-JOINT ASSEMBLY BRAVO X, XR, XZ	KIT TRASMISSIONE BRAVO X, XR, XZ	KIT TRANSMISSION BRAVO X, XR, XZ
33	REC25-29845	25-29845	ARO TÓRICO (.924 x 1.03)	O-RING (.924 x 1.03)	ANELLO (.924 x 1.03)	JOINT TORIQUE (.924 x 1.03)
	REC25-35027	25-35027	ARO TÓRICO (1.046)	O-RING (1.046)	ANELLO (1.046)	JOINT TORIQUE (1.046)
34	REC23-861209A1	23-861209A1	KIT RETENES	SHIFT SHAFT BUSING	KIT TENUTES	KIT JOINTS
35	REC87580		KIT REPARACIÓN TR, TRS	GEARCASE SEAL KIT TR, TRS	KIT RIPARAZIONE TR, TRS	KIT JOINTS TR, TRS
36	REC26-16709A2	26-16709A2	KIT REPARACIÓN BRAVO I, II, III	GEARCASE SEAL KIT BRAVO I, II, III	KIT RIPARAZIONE BRAVO I, II, III	KIT JOINTS BRAVO I, II, III
37	REC16755Q1	16755Q1	KIT RETENES	GEARCASE SEAL KIT	KIT TENUTE	KIT JOINTS
38	RECKITMBRAVO1AL		KIT ÁNODOS AL	ANODE KIT AL	KIT ANODI AL	KIT ANODES AL

BRAVO I

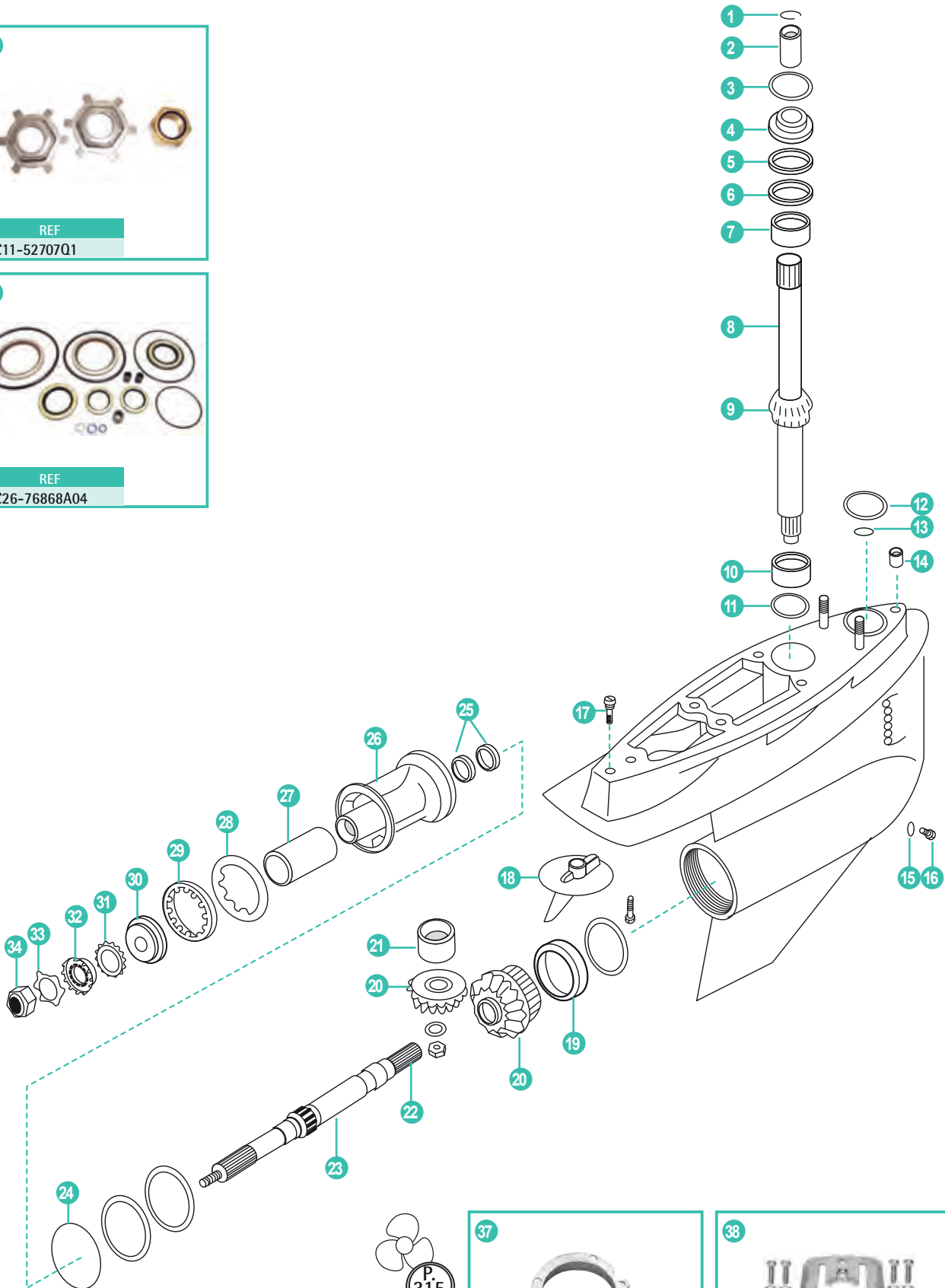

	REF	OEM				
	RM1656-8866A17	8866A64	CARCASA COLA (1656-8863CZ)	LOWER CASE (1656-8863CZ)	CARASSA PIEDE (1656-8863CZ)	CARTER PIED (1656-8863CZ)
1	REC53-88242	53-88242	CLIP	CLIP	CLIP	CLIPS
2	REC88243A3	88243A3	ACOPLE	COUPLING ASSEMBLY	ASSE ACCOPIAMENTO	
3	REC308627	25-20826	ARO TÓRICO	O-RING	ANELLO	JOINT TORIQUE
4	REC23-8M8000506	23-92916	ESPACIADOR	SPACER	DISTANZIALE	CALE
5	REC15-86749A1	15-86749A1	KIT SUPLEMENTOS	SHIM KIT	KIT SPESSORE	KIT CALES
6	RM86739	14-86739	ARANDELA	WASHER	RONDELLA	RONDELLE
7	REC31-86748A1	31-86748A1	COJINETE	BEARING	CUSCINETTO	ROULEMENT
8	RM45-41629A2	41629A2	EJE TRANSMISIÓN	DRIVESHAFT	ASSE TRASMISSIONE	ARBRE TRANSMISSION
9	REC31-86748A1	31-86748A1	COJINETE	BEARING	CUSCINETTO	ROULEMENT
10	REC31-66668A1	66668A1 31-99328A1	COJINETE	BEARING	CUSCINETTO	ROULEMENT
11	REC15-92914A1	15-92914A1	KIT GRUESOS	SHIM KIT	KIT SPESSORE	KIT CALES
12	REC26-455771	26-455771	RETÉN	SEAL	TENUTA	JOINT D'HUILE
13	REC25-33465	25-33465 25-822370	ARO TÓRICO (2.362 x .103)	O-RING (2.362 x .103)	ANELLO (2.362 x .103)	JOINT TORIQUE (2.362 X .103)
14	REC26-36556	26-36556	TUBO AGUA Ø EXT. 12.7 mm	WATER TUBE Ø EXT. 12.7mm	TUBO ACQUA Ø EXT. 12.7 mm	DURITE Ø EXT. 12.7 mm
	REC26-805344	26-805344	TUBO AGUA Ø EXT. 15.88 mm	WATER TUBE Ø EXT. 15.88 mm	TUBO ACQUA Ø EXT. 15.88 mm	DURITE Ø EXT. 15.88 mm
15	REC12-191833	12-191833	JUNTA	GASKET	GUARNIZIONE	JOINT
16	REC22-67892A05	8M0058389	TORNILLO DRENAJE	DRAIN PLUG	VITE DRENAGGIO	VIS VIDANGE
17	REC10-806327	10-806327	TORNILLO	SCREW	VITE	VIS
18	CM762145	76214Q5	ÁNODO ZN	ZN ANODE	ANODO ZN	ANODE ZN
	CM762145A	76514Q5	ÁNODO AL	AL ANODE	ANODO AL	ANODE AL
19	REC31-86752A1	31-86752A1	COJINETE	BEARING	CUSCINETTO	ROULEMENT
20	RM43-14063A1	43-14063A1	KIT PIÑONES (15/19)	BEARING SET (15/19)	KIT CUSCINETTO (15/19)	KIT PIGNON (15/19)
21	REC31-86754T	31-86754T	COJINETE	BEARING	CUSCINETTO	ROULEMENT
22	RM44-41630T	44-850308 44-41630T	EJE HÉLICE	PROPSHAFT	ASSE ELICA	ARBRE HÉLICE
23	REC31-66668A1	66668A1 31-99328A1	COJINETE	BEARING	CUSCINETTO	ROULEMENT
24	REC25-31534	25-31534	ARO TÓRICO	O-RING	ANELLO	JOINT TORIQUE
25	REC26-76868	26-76868	RETÉN ACEITE	OIL SEAL	PARAOLIO	JOINT D'HUILE
26	REC41641A8	41641A8	COJINETE COLA	BEARING	CUSCINETTO	ROULEMENT EMBASE
27	REC31-54042T	31-54042T	COJINETE	BEARING	CUSCINETTO	ROULEMENT
28	REC14-18323	14-18323	ARANDELA	WASHER	RONDELLA	RONDELLE
29	REC8M2011027	8M2011027	TUERCA	NUT	DADO	ÉCROU
30	REC12-835467Q01	12-835467Q01	TOPE HÉLICE	SEPARATOR	FERMO PER ELICA	RONDELLE D'HÉLICE
31	REC13-423511	13-42351-1	CIERRE	LOCK	CHIUSURA	RONDELLE FREIN
32	REC12-31211Q03	12-31211Q03	TOPE CIERRE HÉLICE	WASHER	TAPPO CHIUSURA ELICA	RONDELLE FREIN DE DIABOLO
33	REC90508-ZW1-003	14-816629Q	ARANDELA CIERRE	LOCK WASHER	RONDELLA CHIUSURA	RONDELLE FREIN
34	REC90301-ZW1-003	11-827614	TUERCA CIERRE HÉLICE	LOCK NUT	DADO CHIUSURA	ECROU
35	REC11-52707Q1	11-52707Q1	KIT CIERRE HÉLICE	PROPELLER NUT KIT	KIT CHIUSSURA ELICHA	KIT ÉCROU D'HÉLICE
36	REC26-76868A04	26-76868A04	KIT REPARACIÓN BRAVO I, II, III	GEARCASE SEAL KIT BRAVO I, II, III	KIT RIPARAZIONE BRAVO I, II, III	KIT JOINTS BRAVO I, II, III
37	CM806188		ÁNODO ZN	ANODE ZN	ANODO ZN	ANODE ZN
	CM806188A		ÁNODO AL	ANODE AL	ANODO AL	ANODE AL
	RECKITMBRAVO1AL		KIT ÁNODOS AL	ANODE KIT AL	KIT ANODI AL	KIT ANODES AL
38	CMBRAVO1KITA		KIT ÁNODOS AL	ANODE KIT AL	KIT ANODI AL	KIT ANODES AL
	CMBRAVO1KITM		KIT ÁNODOS MG	ANODE KIT MG	KIT ANODI MG	KIT ANODES MG
	TENKITBRAVOI		KIT ÁNODOS ZN	ANODE KIT ZN	KIT ANODI ZN	KIT ANODES ZN



BRAVO II

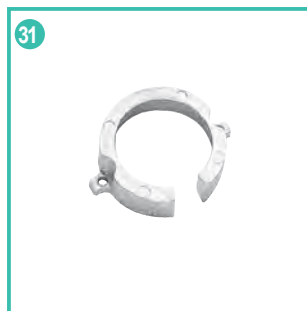
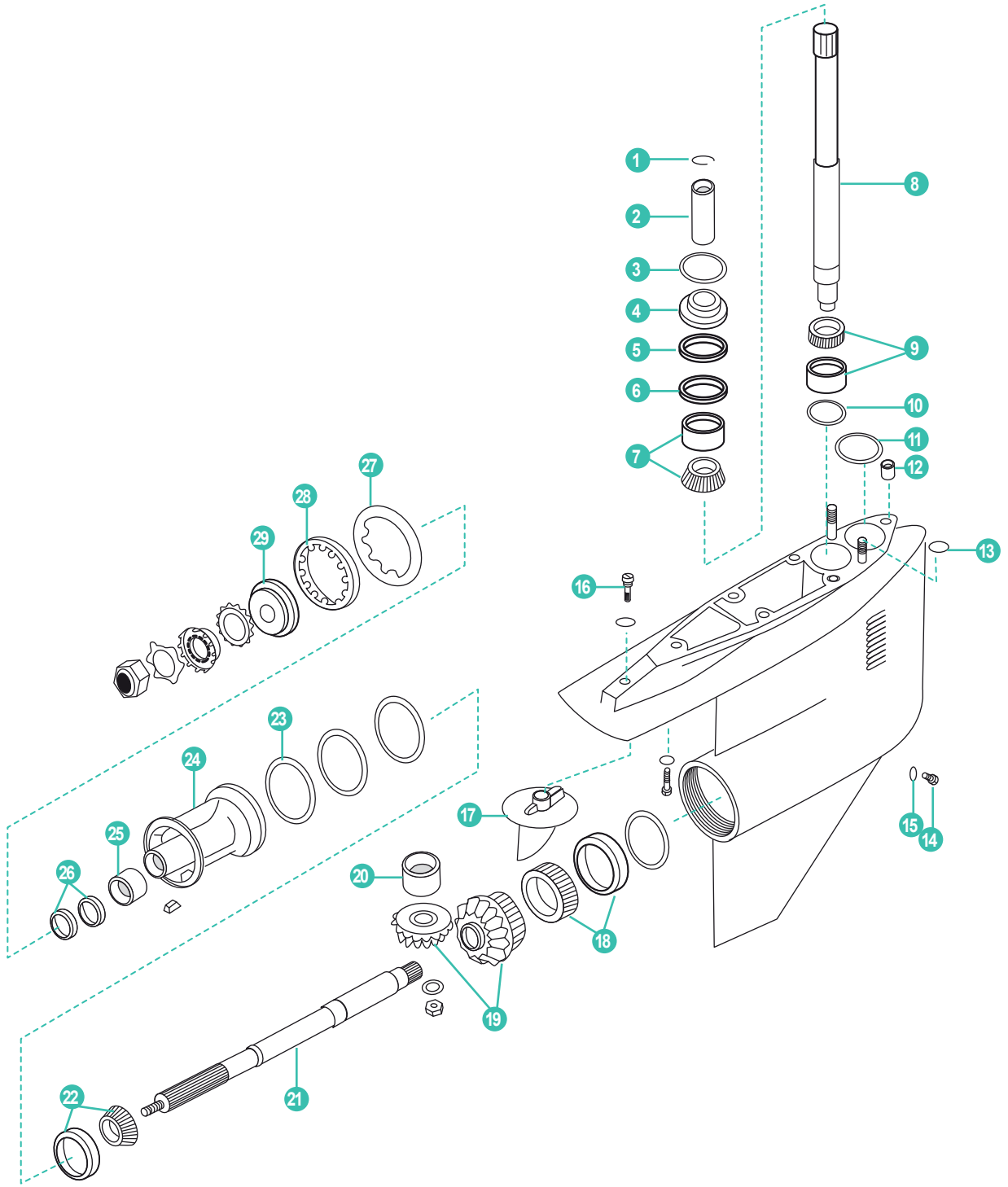

	REF	OEM				
1	REC53-88242	53-88242	CLIP	CLIP	CLIP	CLIPS
2	REC88243A3	88243A3	ACOPLE	COUPLING ASSEMBLY	ACCOPIAMENTO	ACCOUPEMENT
3	REC308627	25-20826	ARO TÓRICO	O-RING	ANELLO	JOINT TORIQUE
4	REC23-8M8000506	92916	ESPACIADOR	SPACER	DISTANZIALE	CALE
5	REC15-86749A1	15-86749A1	KIT GRUESOS	SHIM KIT	KIT SPESSORE	KIT CALES
6	RM86739	14-86739	ARANDELA	WASHER	RONDELLA	RONDELLE
7	REC31-86748A1	31-86748A1	COJINETE	BEARING	CUSCINETTO	ROULEMENT
8	RM45-41629A2	45-41629A2	EJE	DRIVESHAFT	ASSE	ARBRE
9	REC31-66668A1	31-66668A1	COJINETE	BEARING	CUSCINETTO	ROULEMENT
10	REC15-92914A1	15-92914A1	KIT GRUESOS	SHIM KIT	KIT SPESSORE	KIT CALES
11	REC25-33465	25-822370	ARO	O-RING	ANELLO	JOINT TORIQUE
12	REC26-805344	26-805344	RETÉN AGUA Ø15.88 mm	SPEEDOMETER SEA Ø15.88 mm	TENUTA ACQUA Ø15.88 mm	TUBE D'EAU Ø16 mm
	REC26-36556	26-36556	RETÉN AGUA Ø 12.7 mm	SPEEDO GROMMET Ø 12.7 mm	TENUTA ACQUA Ø 12.7 mm	TUBE D'EAU Ø12,7 mm
13	REC26-455771	26-455771	RETÉN	SEAL	PARAOLIO	JOINT D'HUILE
14	REC22-67892A05	22-67892	TORNILLO CON RETÉN CIERRE	DRAINING SCREW SET	VITE CON PARAOLIO CHIUSURA	BOUCHON DE VIDANGE MAGNETIQUE + JOINT
15	REC12-191833	12-191833	JUNTA	GASKET	GUARNIZIONE	JOINT
16	REC10-806327	10-806327	TORNILLO ANODO	ANODE SCREW	VITE ANODO	VIS ANODE
17	CM762144	76214A2	ÁNODO ZN	ANODE ZN	ANODO ZN	ANODE ZN
	CM762144A	76214A2	ÁNODO AL	ANODE AL	ANODO AL	ANODE ZN
18	REC31-86752A1	31-86752A1	COJINETE	BEARING	CUSCINETTO	ROULEMENT
19	RM43-14063A1	43-14063A1	KIT PIÑONES (15/19)	GEAR SET (15/19)	KIT PIGNONI (15/19)	KIT PIGNON (15/19)
20	REC31-86754T	31-86754T	COJINETE	BEARING	CUSCINETTO	ROULEMENT
21	RM44-41630T	44-41630T	EJE HÉLICE	PROP SHAFT	ASSE ELICA	ARBRE HÉLICE
22	REC31-66668A1	31-66668A1	COJINETE	BEARING	CUSCINETTO	ROULEMENT
23	REC25-31534	25-31534	TÓRICA	O-RING	TENUTA	JOINT TORIQUE
24	REC41641A8	41641A8	COJINETE COLA	BEARING CARRIER	CUSCINETTO PIEDE	ROULEMENT DIABOLO
25	REC31-54042T	31-54042T	COJINETE	BEARING	CUSCINETTO	ROULEMENT
26	REC26-76868	26-76868	RETÉN	SEAL	PARAOLIO	JOINT D'HUILE
27	REC14-18323	14-18323	ARANDELA	LOCK WASHER	RONDELLA	RONDELLE
28	REC8M2011027	79448	TUERCA CIERRE COLA	LOCK NUT	RONDELLA CHIUSURA PIEDE	ECROU A CRENAUX
29	REC12-835467Q01	13171	TOPE HÉLICE	SEPARATOR	FERMO PER ELICA	RONDELLE D'HÉLICE
30	REC26-76868A04	26-76868A04	KIT REPARACIÓN BRAVO I, II, III	GEARCASE SEAL KIT BRAVO I, II, III	KIT RIPARAZIONE BRAVO I, II, III	KIT JOINTS BRAVO I, II, III
31	CM806188		ÁNODO ZN	ANODE ZN	ANODO ZN	ANODE ZN
	CM806188A		ÁNODO AL	ANODE AL	ANODO AL	ANODE AL
	RECKITMBRAVO23AL		KIT ÁNODOS AL	ANODE KIT AL	KIT ANODI AL	KIT ANODES AL
32	CMBRAVO2Y3KITA		KIT ÁNODOS AL	ANODE KIT AL	KIT ANODI AL	KIT ANODES AL
	CMBRAVO2Y3KITM		KIT ÁNODOS MG	ANODE KIT MG	KIT ANODI MG	KIT ANODES MG
	TENKITBRAVOII-III		KIT ÁNODOS ZN	ANODE KIT ZN	KIT ANODI ZN	KIT ANODES ZN



BRAVO III

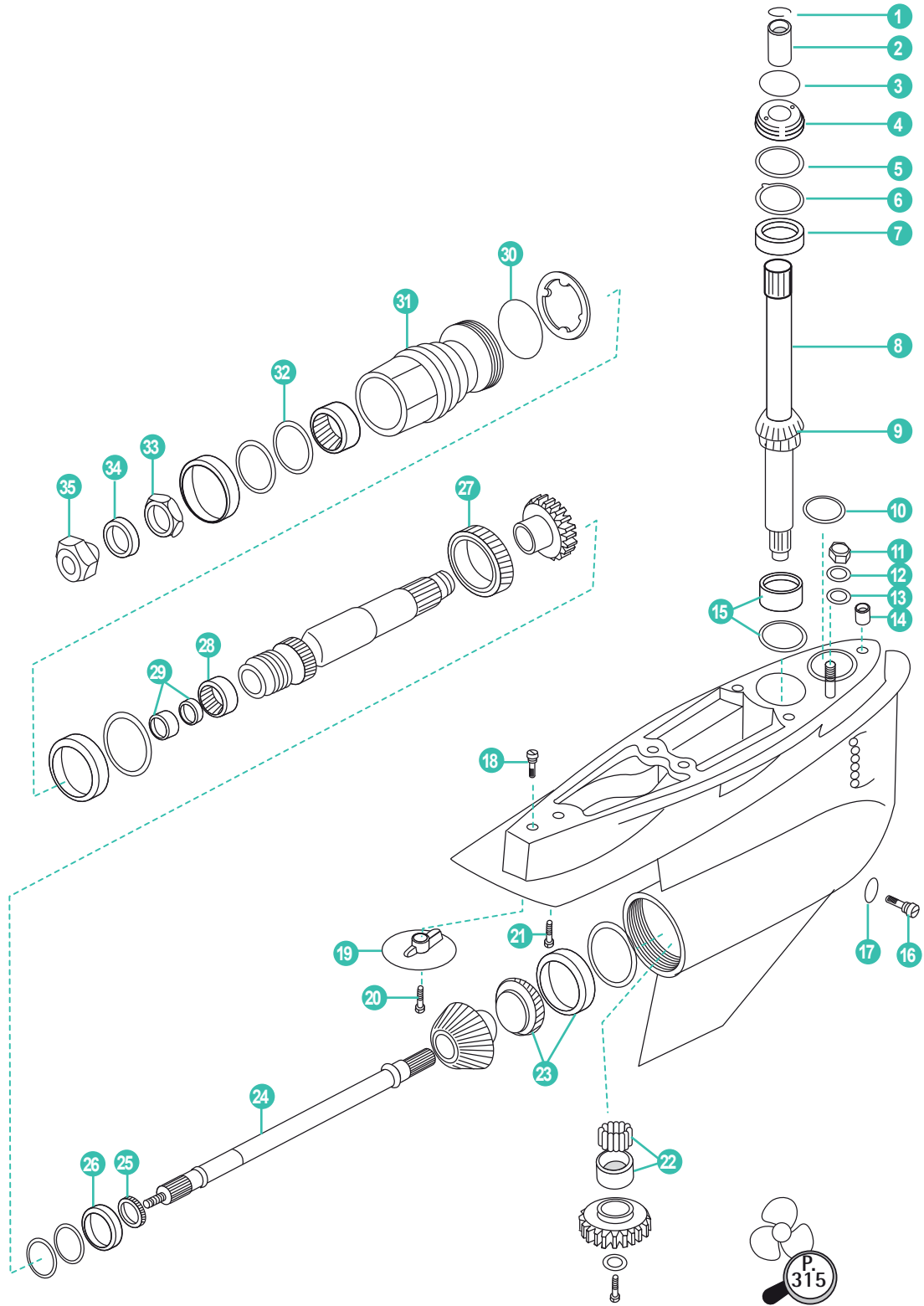

	REF	OEM				
1	REC53-88242	53-88242	RETÉN	SEAL	TENUTA	JOINT D'HUILE
2	REC88243A3	88243A3	ACOPLE	COUPLING	ACCOPIAMENTO	ACCOUPEMENT
3	REC308627	25-20826	ARO TÓRICO	O-RING	ANELLO	JOIN TORIQUE
4	REC23-8M8000506	23-92916	ESPACIADOR	SPACER	DISTANZIALE	CALE
5	REC15-86749A1	15-86749A1	KIT SUPLEMENTOS	SHIM KIT	SPESSORE KIT	KIT CALES
6	RM86739	86739	ARANDELA	WASHER	RONDELLA	RONDELLE
7	REC31-86748A1	31-86748A1	COJINETE	BEARING	CUSCINETTO	ROULEMENT
8	RM45-41629A2	805370A1	EJE (16.085 largo)	DRIVESHAFT (16.085 long)	ASSE (16.085 lungo)	ARBRE (16.085 large)
9	REC31-86748A1	31-86748A1	COJINETE	BEARING	CUSCINETTO	ROULEMENT
10	REC25-33465	25-33465	ARO TÓRICO	O-RING	ANELLO	JOINT TORIQUE
11	REC11-34933	11-859116	TUERCA	NUT	DADO	ÉCROU
12	REC12-45176	12-45176	ARANDELA	WASHER	RONDELLA	RONDELLE
13	REC26-455771	26-45577-1	RETÉN	SEAL	TENUTA	JOINT SPI
14	REC26-805344	26-805344	RETÉN	SEAL	TENUTA	JOINT SPI
15	REC31-66668A1	31-99328A1	COJINETE	BEARING	CUSCINETTO	ROULEMENT
16	REC22-67892A05	22-8M0058389	TORNILLO CON RETÉN	DRAININ SCREW SET	VITE CON TENUTA	VIS AVEC JOINT
17	REC12-191833	12-19183-3	JUNTA	GASKET	GUARNIZIONE	JOINT
18	REC10-806327	10-806327	TORNILLO	SCREW	VITE	VIS
19	CM762144	76214Q5	ÁNODO	ANODE	ANODO	ANODE
	CM762144A	76214Q5	ÁNODO ALDESIGN II	AL ANODE DESIGN II	ANODO AL DESIGN II	ANODE AL DESIGN II
20	REC313715	10-865321	TORNILLO	SCREW	VITE	VIS
21	REC10-816601	10-816601	TORNILLO	SCREW	VITE	VIS
22	RM86754T	86754T	COJINETE	BEARING	CUSCINETTO	ROULEMENT
23	REC31-86752A1	31-86752A1	COJINETE	BEARING	CUSCINETTO	ROULEMENT
24	RM44-865322T	44-865322T	EJE	SHAFT	ASSE	ARBRE
25	RM805322	805322	COJINETE	BEARING	CUSCINETTO	ROULEMENT
26	REC805100	805100	SEPARADOR	THRUST WASHER	SEPARATORE	RONDELLE DE BUTEE
27	RM805182A1	805182A1	COJINETE	BEARING	CUSCINETTO	ROULEMENT
28	RM57410	57410	COJINETE	BEARING	CUSCINETTO	ROULEMENT
29	REC26-8M0033407	26-8M0033407	RETÉN ACEITE	OIL SEAL	PARAOLIO	JOINT D'HUILE
30	REC3852865	25-805331	ARO TÓRICO	O-RING	ANELLO	JOINT TORIQUE
31	REC865876A01	865876A01	DIÁBOLO COMPLETO	CARRIER ASSY	COPERCHIO CUSCINETTO COMPLETO	DIABOLO COMPLET
32	REC26-861694	26-861694	RETÉN ACEITE	OIL SEAL	PARAOLIO	JOINT D'HUILE
33	REC11-8M0105210	11-8M0105210	TUERCA	NUT	DADO	ÉCROU
34	REC805101T	805101T	SEPARADOR	THRUST WASHER	SEPARATORE	RONDELLE DE BUTEE
35	REC11-862907	11-862907	TUERCA	NUT	DADO	ÉCROU
36	REC26-76868A04	26-76868A04	KIT REPARACIÓN BRAVO I, II, III	GEARCASE SEAL KIT BRAVO I, II, III	KIT RIPARAZIONE BRAVO I, II, III	KIT JOINTS BRAVO I, II, III
37	CMPNDAF14UNS		KIT ÁNODOS ZN	ANODE KIT ZN	KIT ANODI ZN	KIT ANODES ZN
	CMPNDAF14UNSA		KIT ÁNODOS AL	ANODE KIT AL	KIT ANODI AL	KIT ANODES AL
38	CM806188		ÁNODO ZN	ANODE ZN	ANODO ZN	ANODE ZN
	CM806188A		ÁNODO AL	ANODE AL	ANODO AL	ANODE AL
	RECKITMBRAVO3AL		KIT ÁNODOS AL	ANODE KIT AL	KIT ANODI AL	KIT ANODES AL
39	CMBRAVO3KITA		KIT ÁNODOS AL	ANODE KIT AL	KIT ANODI AL	KIT ANODES AL
	CMBRAVO3KITM		KIT ÁNODOS MG	ANODE KIT MG	KIT ANODI MG	KIT ANODES MG
	TENKITBRAVOIII-04		KIT ÁNODOS ZN	ANODE KIT ZN	KIT ANODI ZN	KIT ANODES ZN



REC80W90U3
REC80W90U6
RECGREU1
RECGREU12

P
25

ÁNODO

ANODE

ANODI

ANODE

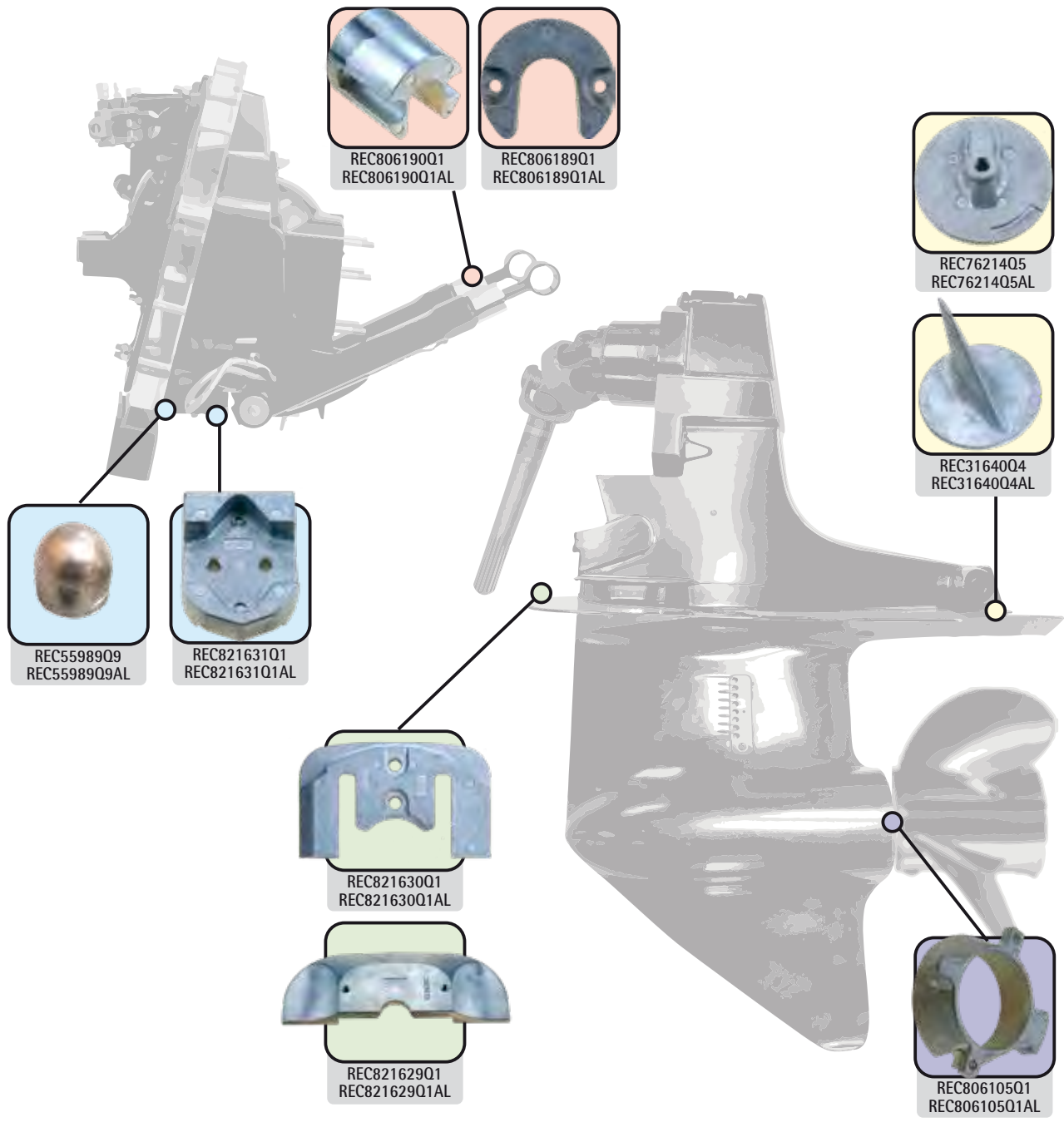



	PLACA PLATE PIASTRA PLAQUE	TRANSOM	PISTÓN PISTON PISTONE PISTON	HÉLICE PROPELLER ELICA HELICE	TRIM TAB	KITS
BRAVO I	REC821630Q1 REC821630Q1AL		REC806190Q1 REC806190Q1AL		REC76214Q5 REC76214Q5AL	RECKITMBRAVO1ZN RECKITMBRAVO1M RECKITMBRAVO1AL RECKITMBRAVO23ZN RECKITMBRAVO23M RECKITMBRAVO23AL RECKITMBRAVO3M RECKITMBRAVO3AL
BRAVO II	REC821630Q1 REC821630Q1AL		REC806190Q1 REC806190Q1AL		REC76214Q5 REC76214Q5AL	RECKITMBRAVO1M RECKITMBRAVO1AL RECKITMBRAVO23ZN RECKITMBRAVO23M RECKITMBRAVO23AL RECKITMBRAVO3M RECKITMBRAVO3AL
BRAVO III	REC821630Q1 REC821630Q1AL		REC806190Q1 REC806190Q1AL		REC76214Q5 REC76214Q5AL	RECKITMBRAVO1M RECKITMBRAVO1AL RECKITMBRAVO23ZN RECKITMBRAVO23M RECKITMBRAVO23AL RECKITMBRAVO3M RECKITMBRAVO3AL
ALPHA ONE		REC821631Q1 REC821631Q1AL	REC806189Q1 REC806189Q1AL		REC31640Q4 REC31640Q4AL	RECKITMALPHA1ZN RECKITMALPHA1M RECKITMALPHA1AL RECKITMALPHA2ZN RECKITMALPHA2M RECKITMALPHA2AL
ALPHA ONE II GEN	REC821629Q1 REC821629Q1AL	REC821631Q1 REC821631Q1AL	REC806189Q1 REC806189Q1AL	REC806105Q1 REC806105Q1AL	REC76214Q5 REC76214Q5AL	RECKITMALPHA1M RECKITMALPHA1AL RECKITMALPHA2ZN RECKITMALPHA2M RECKITMALPHA2AL

	KG (kg)	OEM	
ZN REC821630Q1	0,98	821630Q1	
AL REC821630Q1AL			

	KG (kg)	OEM	
ZN REC821631Q1		821631Q1	
AL REC821631Q1AL			

	KG (kg)	OEM	
ZN REC821629Q1	0,70	821629Q1	
AL REC821629Q1AL			

	KG (kg)	OEM	
ZN REC806190Q1	0,34	806190Q1	
AL REC806190Q1AL			

	KG (kg)	OEM	
ZN REC806189Q1	0,12	806189Q1	
AL REC806189Q1AL			

	KG (kg)	OEM	
ZN REC76214Q5	0,34	76214Q5	
AL REC76214Q5AL			

	KG (kg)	OEM	
ZN REC31640Q4		31640Q4	
AL REC31640Q4AL			

	KG (kg)	OEM	
ZN REC806105Q1	0,23	806105Q1	
AL REC806105Q1AL			

	KG (kg)	OEM	
ZN REC55989Q9		55989Q9	
AL REC55989Q9AL			
MG REC55989Q9M			

REF	OEM	KG (kg)		
ZN REC34127T2	34127	0,60	80 - 140 HP	
AL REC34127T2AL				

REF	OEM	KG (kg)		
ZN REC94286T1	94286	0,27	25 HP	
AL REC94286T1AL				

REF	OEM	KG (kg)		
ZN REC47820A1	47820	0,31	20 HP	
AL REC47820A1AL				

REF	OEM	KG (kg)		
ZN REC46399	46399	0,40	50 - 140 HP	
AL REC46399AL				

REF	OEM	KG (kg)		
ZN REC806188Q01	806188	0,17	BRAVO I, III	
AL REC806188Q01AL				

REF	OEM	KG (kg)		
ZN REC762144	76214-4	0,26		
AL REC762144AL				

REF	OEM	KG (kg)		
ZN REC7614T1	76214	0,31	VERADO - BRAVO	
AL REC7614T1AL				

REF	OEM	KG (kg)		
ZN REC865182Q01	865182	0,52	BRAVO III	
AL REC865182Q01AL				

REF	OEM	KG (kg)		
ZN REC43994A2	43994	0,90	ALPHA GEN II BRAVO	
AL REC43994A2AL				

KITS ANODOS			ANODES KIT	KIT ANODI	KIT ANODES
REF	OEM				
ZN RECKITMALPHA1ZN			RECKITMALPHA1ZN RECKITMALPHA1AL RECKITMALPHA1M	RECKITMALPHA1ZN RECKITMALPHA1AL RECKITMALPHA1M	RECKITMALPHA2AL RECKITMALPHA2AL RECKITMALPHA2M
AL RECKITMALPHA1AL	888756Q04	ALPHA 1			
MG RECKITMALPHA1M					
ZN RECKITMALPHA2ZN					
AL RECKITMALPHA2AL	888756Q03	ALPHA 2			
MG RECKITMALPHA2M					

KITS ANODOS			ANODES KIT	KIT ANODI	KIT ANODES
REF	OEM				
ZN RECKITMBRAVO1ZN			RECKITMBRAVO1ZN RECKITMBRAVO1AL RECKITMBRAVO1M	RECKITMBRAVO3ZN RECKITMBRAVO3AL RECKITMBRAVO3M	RECKITMBRAVO23ZN RECKITMBRAVO23AL RECKITMBRAVO23M
AL RECKITMBRAVO1AL	888758Q02	BRAVO 1			
MG RECKITMBRAVO1M					
ZN RECKITMBRAVO23ZN					
AL RECKITMBRAVO23AL	888761Q03	BRAVO 2			
MG RECKITMBRAVO23M					
ZN RECKITMBRAVO3ZN					
AL RECKITMBRAVO3AL	888761Q04	BRAVO 3			
MG RECKITMBRAVO3M					



ÁNODO		ANODE	ANODI	ANODE
REF	OEM	 (kg)		
ZN TEN00800	1301339	0,48	50 HP	
REF	OEM	 (kg)		
ZN TEN00807	55989	0,10	ALPHA ONE BRAVO I	
REF	OEM	 (kg)		
ZN TEN00827	17264	0,51	FORMULA 60 HP	
REF	OEM	 (kg)		
ZN TEN00814	821629	0,70	ALPHA ONE ALPHA GEN II	
REF	OEM	 (kg)		
ZN TEN00815	821630	0,98	BRAVO I, II, III	
REF	OEM	 (kg)		
ZN TEN00820	76214-5	0,34	ALPHA	
REF	OEM	 (kg)		
ZN TEN00823	823912	0,01	20	
ZN TEN00824	823913	0,02	24	

REF	OEM	KG (kg)		
ZN TEN00819	806105	0,23		PISTON ALPHA ONE ALPHA GEN II



REF	OEM	KG (kg)		
ZN TEN00818	806190	0,34		PISTON BRAVO



REF	OEM	KG (kg)		
ZN TEN00839	853762	0,15		



REF	OEM	KG (kg)		
ZN TEN00817	806189	0,12		PISTON ALPHA



KITS DE ÁNODOS

ANODES KIT

KIT ANODI

KIT ANODES

REF	OEM	KG (kg)		
ZN TENKITALPHAONE/1	8887562Q02	1,83		MR, ALPHA ONE (1984-1990)



REF	OEM	KG (kg)		
ZN TENKITALPHAONE/2	888756Q01 888756Q03	2,52		ALPHA ONE GEN II



REF	OEM	KG (kg)		
ZN TENKITBRAVOI	888758Q01	2,34		BRAVO I





REF	OEM	KG (kg)		
ZN TENKITBRAVOII-III	888761Q01	2,13		BRAVOII & III





REF	OEM	KG (kg)		
ZN TENKITBRAVOIII-04	888761Q02	3		BRAVOIII (2004+)



CUMMINS

KIT		a (mm)	a1 (mm)	d (mm)	p (mm)	c (mm)	e (mm)	
TEN02040		65	15	18	16 x 1,5			
TEN02041		31	13	16	3/8"			
ZN TEN02042		20	8	10	M6			
TEN02043T	TEN02043	50	10	16	15,5	22	1/2" gas	
TEN02044T	TEN02044	TEN02044TP	50	10	16	7/16"	22	





REF	OEM	KG (kg)	(mm)	
ZN TEN01320T	97-8M0151541 879194217 8M0067625 8M0067062 8M0150234 811487		20 x Ø ext. 15 M18x1.5	QSD 2.0/2.8/4.2



new



ÁNODO

ANODE

ANODI

ANODE

REF	OEM	(kg)	
ZN CMX-1	85538	0,136	ALPHA I
AL CMX-1A	823341	0,13	



REF	OEM	(kg)	
ZN CM806105	806188A1	0,23	ALPHA ONE, GEN II
AL CM806105A		0,09	



REF	OEM	(kg)	
ZN CM762144	76214-4	0,31	BRAVO III (2003+)
AL CM762144A		0,13	



REF	OEM	(kg)	
ZN CM55989	55989A9	0,11	ALPHA ONE, GEN II
AL CM55989A	55989Q9	0,09	



REF	OEM	(kg)	
ZN CM762145	76214A2	0,33	ALPHA ONE GEN II BRAVO III (-2003)
AL CM762145A	76214Q5	0,13	



REF	OEM	(kg)	
ZN CM821629	821629Q1	0,78	ALPHA ONE, GEN II
AL CM821629A		0,30	



REF	OEM	(kg)	
ZN CM76214Q5	76214Q5	0,33	BRAVO 4 225-250 HP



REF	OEM	(kg)	
ZN CM34762	34762A1	0,24	BRAVO
AL CM34762A		0,09	



REF	OEM	(kg)	
ZN CM31640	31640A4	0,55	ALPHA ONE
AL CM31640A		0,13	



REF	OEM	(kg)	
ZN CM806188	806188A1	0,15	BRAVO
AL CM806188A		0,06	



REF	OEM	(kg)	
ZN CM46399	46399A1	0,36	ALPHA ONE GEN II
AL CM46399A	82277Q1	0,14	



REF	OEM	(kg)	
ZN CM821630	821630A1/Q1	1,00	BRAVO
AL CM821630A		0,39	



REF	OEM	(kg)	
ZN CM34127	34127T2	0,59	BRAVO
AL CM34127A		0,22	



REF	OEM	(kg)	
ZN CM43994	43994A2 821631A1	0,95	Antiguos old vecchio Anciennes



REF	OEM	(kg)	
ZN CM806189	806189Q1	0,10	GEN II
AL CM806189A		0,04	



REF	OEM	(kg)	
ZN CM821631	43994A2 821631A1	0,89	Modernos New style
AL CM821631A		0,35	Moderno Nouveaux



REF	OEM	(kg)	
ZN CM806190	806190Q1	0,35	BRAVO
AL CM806190A		0,14	





KITS DE ÁNODOS

ANODES KIT

KIT ANODI

KIT ANODES

REF	ANODO ANODE	(kg)	
ZN CMCC	CMC	0,93	ALPHA I , MR



REF	OEM	(kg)	
ZN CMPNCF16Z		0,93	ALPHA I , BRAVO I
AL CMPNCF16A		0,54	



REF	OEM	(kg)	
ZN			BRAVO II
AL CMPNEZF14A		0,65	



REF	OEM	(kg)	
ZN CMPNDAF14UNSA		0,93	BRAVO III (-2003)
AL CMPNDAF14UNSA		0,54	



REF	(kg)	TIPO TYPE TIPO TIPO	
ZN CMPNAZ	0,09	A	BRAVO
AL CMPNAA	0,03		
ZN CMPNBZ	0,23	B	BRAVO
AL CMPNBA	0,09		
ZN CMC	0,45	C	BRAVO
AL CMPNCA	0,19		
ZN CMPNDZ	0,68	C	BRAVO
AL CMPNDA	0,29		



REF	OEM	(kg)	
ZN CM865182CZ		0,51	BRAVO III (2004+)
AL CM865182CA		0,42	



REF	OEM	
MG CMBRAVO3KITM	888761Q02	BRAVO III (2004+)
AL CMBRAVO3KITA		



REF	OEM	
MG CMALPHAGEN1KITM	888756Q02	MR, ALPHA ONE (1984-90)
AL CMALPHAGEN1KITA		



REF	OEM	
MG CMALPHAKITM	888756Q01	ALPHA ONE
AL CMALPHAKITA	888756Q03	GEN II



REF	OEM	
MG CMBRAVO1KITM	888758Q01	BRAVO I
AL CMBRAVO1KITA		



REF	OEM	
MG CMBRAVO2Y3KITM	888761Q01	BRAVO II BRAVO III
AL CMBRAVO2Y3KITA		



TRANSOM

KITS DE TRANSOM Y PISTON DIRECCION ALPHA ONE GEN I & II

GIMBAL HOUSING & POWER STEERING CYLINDER KIT ALPHA ONE GEN I & II

TRANSOM E PISTONE STERZO ALPHA ONE GEN I & II

KIT TRANSOM ET PISTON DE DIRECTION ALPHA ONE GEN I & II

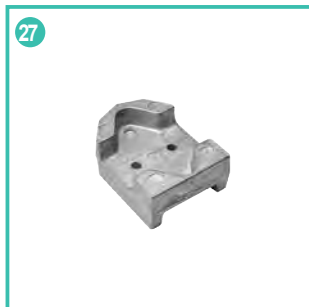
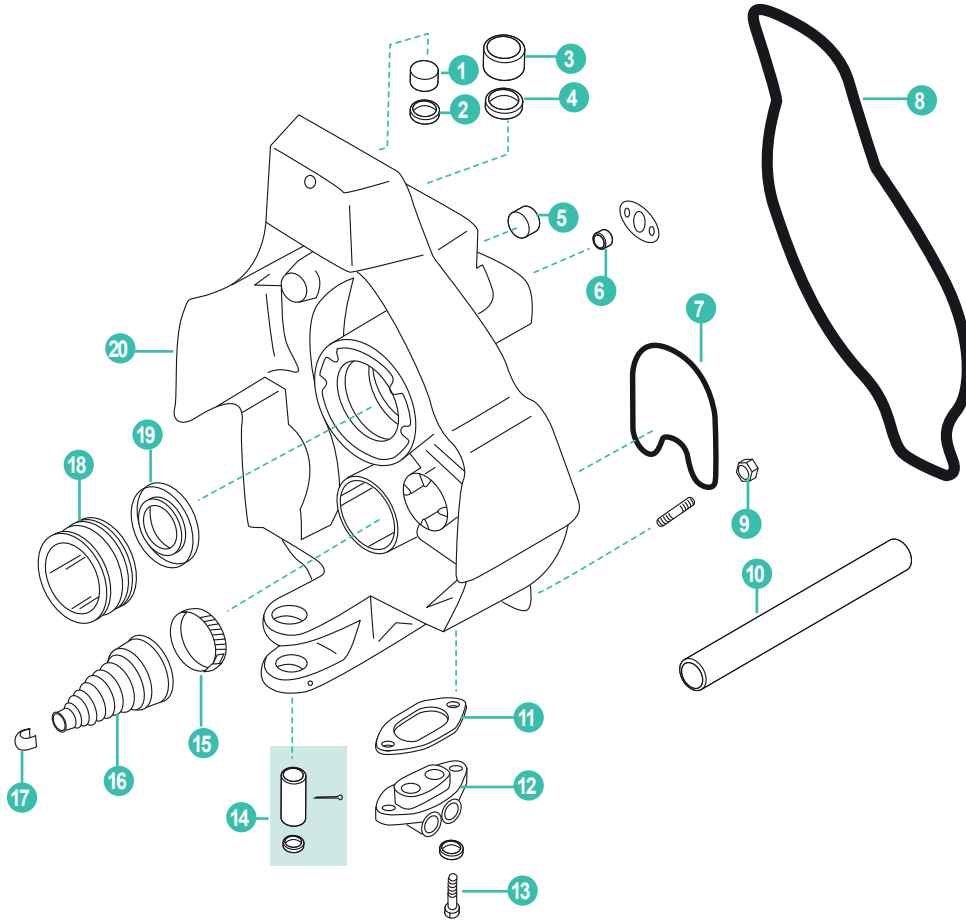

	REF	OEM				
1	RM23-98356	23-98356	CASQUILLO SUPERIOR	UPPER BUSHING	BOCCOLA SUPERIORE	BAGUE SUPÉRIEURE
2	REC26-54925	26-54925	RETÉN (Alpha one)	SEAL (Alpha one)	PARAOLIO (Alpha one)	JOINT (Alpha one)
3	RM23-983571	23-983571	CASQUILLO INFERIOR	LOWER BUSHING	BOCCOLA INFERIORE	BAGUE INFÉRIEUR
4	REC26-55682	26-55682	RETÉN (Alpha one)	SEAL (Alpha one)	PARAOLIO (Alpha one)	JOINT (Alpha one)
	REC26-8M2005029	26-416071	RETÉN (Alpha one Gen II)	SEAL (Alpha one Gen II)	PARAOLIO (Alpha one Gen II)	JOINT (Alpha one Gen II)
5	REC22-73379	22-73379	TAPÓN (.250-18)	CAP (.250-18)	TAPPO (.250-18)	BOUCHON (.250-18)
6	RM23-816599	23-816599	CASQUILLO	BUSHING	BOCCOLA	BAGUE
7	REC41802	41802	RETÉN	SEAL	TENUTA	JOINT D'HUILE
8	REC43713	43713	JUNTA TRANSOM (Gen II, Bravo)	BLACKHAWK TRANSOM SEAL (Gen II, Bravo)	GUARNIZIONE TRANSOM (Gen II, Bravo)	JOINT TRANSOM (Gen II, Bravo)
	REC65533A1	65533A1	JUNTA TRANSOM (MC1/R/Alpha one)	TRANSOM SEAL (MC1/R/Alpha one)	GUARNIZIONE TRANSOM (MC1/R/Alpha one)	JOINT TRANSOM (MC1/R/Alpha one)
9	REC11-34933	11-34933	TUERCA	NUT	DADO	ÉCROU
10	REC32-4172533	32-4172533	TUBO AGUA Ø 3/4"	Ø 3/4" WATER HOSE	Ø 3/4" TUBO ACQUA	DURITE ENTREE D'EAU Ø 3/4"
	REC32-32461	32-32461	TUBO AGUA Ø 5/8"	Ø 5/8" WATER HOSE	Ø 5/8" TUBO ACQUA	DURITE ENTREE D'EAU Ø 5/8"
11	REC27-988231	27-988231	JUNTA	GASKET	GUARNIZIONE	JOINT
12	REC8M0080805	8M0080805	KIT CONECTOR	TRIM CONNECTOR KIT	KIT CONNETTORE TRIM,	KIT CONNECTEUR
13	REC10-28668	10-28636	TORNILLO	SCREW	VITE	VIS
14	REC17-8M0073409	8M0073409	KIT PIN	KIT PIN	KIT SPINOTTO	KIT CLAVETTE
15	REC54-815504320	54-815504320	ABRAZADERA	CLAMP	FASCETTA	COLLIER
16	REC74639Q02	74639Q02	FUELLE CABLE CAMBIO	SHIFT BELLOW	CAVO CAMBIO A SOFFIETTO	SOUFFLET CÂBLE CHANGEMENT
17	REC54-38863	54-38863	ABRAZADERA	CLAMP	FASCETTA	COLLIER
18	REC30-879194A01	30-879194A01	COJINETE TRANSOM (Alpha one Gen I, II)	GIMBAL BEARING FOR TRANSOM (Alpha one Gen I, II)	CUSCINETTO TRANSOM (Alpha one Gen I, II)	ROULEMENT TRANSOM (Alpha one Gen I, II)
19	REC26-88416	26-88416	RETÉN	SEAL	PARAOLIO	JOINT
20	RM94989A6	94989A6	TRANSOM GEN I (eje cuadrado / estriado)	GEN I TRANSOM (square / splined shaft)	TRANSOM GEN I (asse quadrato / scanalato)	TRANSOM GEN I (axe carré / cannelé)
	RM42260A6	42260A6	TRANSOM GEN I (eje cuadrado / cuadrado)	GEN I TRANSOM (squared fixation shaft)	TRANSOM GEN I (asse quadrato)	TRANSOM GEN I (axe carré)
	RM43881A14	8M0062568	TRANSOM (1991+) GEN II	GIMBAL HOUSING ASSY. (1991+)	TRANSOM (1991+) GEN II	TRANSOM (1991+) Gen II
21	REC22-88847A1	22-88847A1	KIT TUERCA Y TAPONES	PLUG KIT	KIT DADO TAPPO	KIT ÉCROU ET BOUCHONS
22	REC30-879194A01	30-879194A01	COJINETE TRANSOM (Alpha one Gen I, II)	GIMBAL BEARING FOR TRANSOM (Alpha one Gen I, II)	CUSCINETTO TRANSOM (Alpha one Gen I, II)	ROULEMENT TRANSOM (Alpha one Gen I, II)
			CONECTOR HIDRÁULICO	HYDRAULIC CONNECTOR	CONNETTORE IDRÁULICO	JOINT
23	REC27-47644-1	27-47644-1	Alpha One S (1986-89)	Alpha One S (1986-89)	Alpha One S (1986-89)	Alpha One S (1986-89)
			SSM II / III / IV / V (1982-95)	SSM II / III / IV / V (1982-95)	SSM II / III / IV / V (1982-95)	SSM II / III / IV / V (1982-95)
			Para conector: 47347	For connector: 47347	Per connettore: 47347	Pour connecteur: 47347
24	REC8M0080805	8M0080805	KIT CONECTOR TRIM	TRIM CONNECTOR KIT	KIT CONNETTORE TRIM	KIT CONECTEUR TRIM
	CM55989		ÁNODO ZN	ANODE ZN	ANODO ZN	ANODE ZN
25	CM55989A	55989Q9	ÁNODO AL	ANODE AL	ANODO AL	ANODE AL
	REC55989Q9		KIT ÁNODO AL	ANODE AL KIT	KIT ANODO AL	KIT ANODE AL
26	REC27-995061	27-995061	JUNTA	GASKET	GUARNIZIONE	JOINT
	CM821631	821631Q1	ÁNODO ZN	ANODE ZN	ANODO ZN	ANODE ZN
27	CM821631A	821631Q1	ÁNODO AL	ANODE AL	ANODO AL	ANODE AL

TRANSOM COMPLETO			TRANSOM ASSY			TRANSOM COMPLETO			TRANSOM COMPLET		
REF	OEM		REF	OEM		REF	OEM		REF	OEM	
TRANSONALPHA1	6-601000CP	Alpha One Gen I	TRANSONALPHA2G	6-6111002LP	Alpha One Gen II						
											

CAMPANA TRANSOM, CABLE CAMBIO Y BOMBA DIRECCION

TRANSOM PLATE, SHIFT CABLE & PUMP ASSY. POWER STEERING

CAMPANA TRANSOM, CAVO CAMBIO E POMPA STERZO

CASQUE, CÂBLE CHANGEMENT ET POMPA DIRECTION



REF REC87-814281A5



REF RM8M0052936



REF REC87-808009A2



REF REC8M0052939



REF REC10-31700



REF REC73873A1



REF REC861578

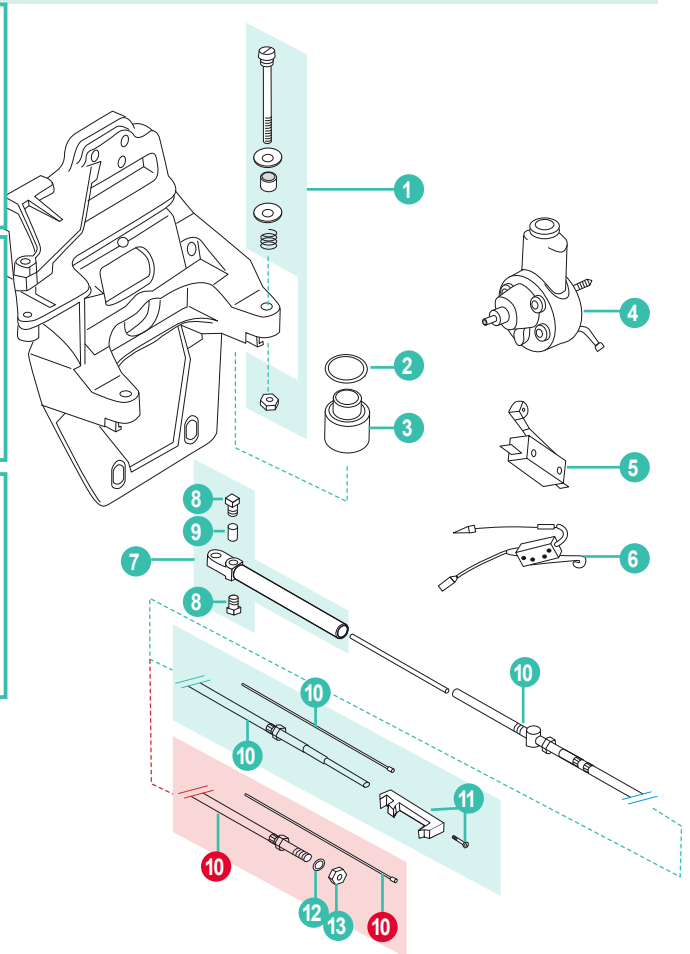

	REF	OEM				
1	REC10-97934A1	10-97934A1	KIT MONTAJE SILENTBLOCK CAMPANA	MOTOR MOUNT BOLT KIT	KIT SILENTBLOCK CAMPANA	KIT VISSERIE
2	REC23-99322	23-99322	ESPACIADOR SILENTBLOCK	SILENTBLOCK SPACER	SILENTBLOCK DISTANZIALE	CALE
3	REC865329A02	865329A02	SILENTBLOCK MOTOR	MOTOR MOUNT SILENTBLOCK	SILENTBLOCK MOTORE	KIT SILENTBLOCK MOTEUR
4	REC16792A39	16792A39	BOMBA DIRECCION	PUMP ASS. POWER STEERING	POMPA DI STERZO	POMPE DIRECTION
5	RM864363A1	864363A1	MICRORRUPTOR ANTIGUO	SHIFT PLATE KIT, OLD	MICROINTERRUTTORE VECCHIO	MICROSWITCH DE TRANSOM ANCIEN
6	RM864364A1	864364A1	MICRORRUPTOR	SHIFT PLATE KIT	MICROINTERRUTTORE	MICROSWITCH
7	REC02644		GUÍA CABLE CAMBIO	GUIDE	GUIDA CAVO CAMBIO	EMBOUIT DE CABLE D'INVERSEUR
8	REC10-20518	10-20518	TORNILLO	BOLT	VITE	VIS
9	REC43436	43436	ANCLAJE	ANCHOR	SEDE	ANCRAGE
10	REC865436A02	865436A02	CABLE CAMBIO (R/MR/Alpha one Gen II)	(R/MR/Alpha one Gen II) SHIFT CABLE	CAVO CAMBIO (R/MR/Alpha one Gen II)	CÂBLE CHANGEMENT (R/MR/Alpha one Gen II)
	RM19543A10	865436A02	CABLE CAMBIO ORIGINAL (R/MR/Alpha one Gen II)	(R/MR/Alpha one Gen II) SHIFT CABLE ORIGINAL	CAVO CAMBIO ORIGINAL (R/MR/Alpha one Gen II)	CABLE CHANGEMENT ORIGINAL (R/MR/Alpha one Gen II)
	REC865437A02	865437A02	CABLE CAMBIO (Bravo)	(Bravo) SHIFT CABLE	CAVO CAMBIO (Bravo)	CÂBLE CHANGEMENT (Bravo)
11	REC8507522	8507522 + 10-31700	KIT ACOPLE CABLE CAMBIO	SHIFT CABLE SLIDE	KIT ACCOPIAMENTO CAVO CAMBIO	KIT ATTACHE CABLE
12	REC12-815472	12-815472	ARANDELA (Bravo)	WASHER (Bravo)	RONDELLA (Bravo)	RONDELLE (Bravo)
13	RM11-49910	11-49910	(Bravo)	NUT (Bravo)	DADO (Bravo)	ÉCROU (Bravo)
14	REC87-814281A5	87-814281A5	MICRORRUPTOR 3.0L, LX, 4.3L, LXL, 5.0L et 5.7, LX (1996+)	SHIFT PLATE KIT 3.0L, LX, 4.3L, LXL, 5.0L et 5.7, LX (1996+)	MICROINTERRUTTORE 3.0L, LX, 4.3L, LXL, 5.0L et 5.7, LX (1996+)	MICROSWITCH 3.0L, LX, 4.3L, LXL, 5.0L et 5.7, LX (1996+)
15	RM8M0052936	87-8M0052936 87-808009A1 87-808009A3	MICRORRUPTOR 4.3MPI, 5.0L MPI, 350MAG MPI, MX, 6.2L MPI, 4.3, 5.0, 5.7L EFI, LX	SHIFT PLATE KIT 34.3MPI, 5.0L MPI, 350MAG MPI, MX, 6.2L MPI, 4.3, 5.0, 5.7L EFI, LX	MICROINTERRUTTORE 4.3MPI, 5.0L MPI, 350MAG MPI, MX, 6.2L MPI, 4.3, 5.0, 5.7L EFI, LX	MICROSWITCH 4.3MPI, 5.0L MPI, 350MAG MPI, MX, 6.2L MPI, 4.3, 5.0, 5.7L EFI, LX
16	REC87-808009A2	87-808009A2 87-8M0052935	MICRORRUPTOR 4.3MPI, 5.0L MPI, 350MAG MPI, MX, 6.2L MPI	SHIFT PLATE KIT 4.3MPI, 5.0L MPI, 350MAG MPI, MX, 6.2L MPI	MICROINTERRUTTORE 4.3MPI, 5.0L MPI, 350MAG MPI, MX, 6.2L MPI	MICROSWITCH 4.3MPI, 5.0L MPI, 350MAG MPI, MX, 6.2L MPI
17	REC8M0052939	8M0052939 889514A01 814281A7	INTERRUPTOR DIGITAL CAMBIO GASOLINA Y GASOIL	SWITCH DIGITAL THROTTLE FUEL & DIESEL	DIGITAL INTERRUPTORE DIESEL E BENZINA	DIGITAL INTERRUPTEUR DIESEL ET ESSENCE
18	REC10-31700	10-31700	TORNILLO	SCREW	VITE	VIS
19	REC73873A1	73873A1	POLEA "V" BOMBA SERVO	P/S PUMP PULLEY	PULEGGIA "V"	POULIE "V"
20	REC861578	861578	POLEA SERPENTÍN	P/S PUMP PULLEY	PULEGGIA SERPENTINA	POULIE SERPENTINE

**SOPORTE TRANSOM
ALPHA ONE GEN II**

**GIMBAL HOUSING RING
ASSEMBLY
ALPHA ONE GEN II**

**SUPPORTO TRANSOM
ALPHA ONE GEN II**

**SUPPORT TRANSOM
ALPHA ONE GEN II**



REF
REC805320A03

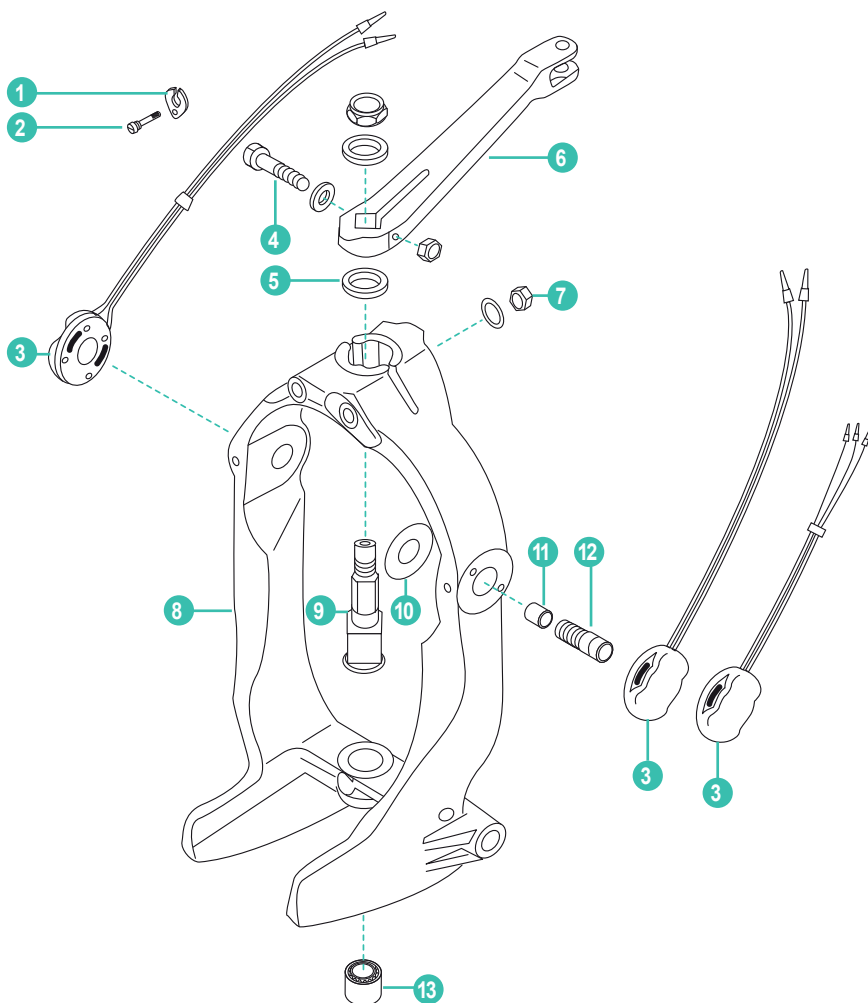

	REF	OEM				
1	RM54-12078	54-12078	ABRAZADERA	CLAMP	FASCETTA	COLLIER
2	RM10-28635	10-28635	TORNILLO SUJECCIÓN	SCREW	VITE	VIS
3	REC805320A03	805320A03	KIT SENSORES TRIM ANALÓGICO	TRIM SENSOR KIT. ANALOGICAL	KIT SENSORI TRIM	KIT SONDE DE TRIM
	REC8M0095310	8M0095310	KIT SENSOR TRIM DIGITAL	TRIM SENSOR KIT. DIGITAL	SENSORE TRIM DIGITAL	SONDE DE TRIM DIGITAL
4	RM10-807204	10-807204	TORNILLO	SCREW	VITE	VIS
5	RM12-98548	12-98548	ARANDELA	WASHER	RONDELLA	RONDELLE
6	RM866322A01	866322A01	BIELA DIRECCIÓN	LEVER ASSY	BIELLA STERZO	PIVOT DE DIRECTION
7	REC11-862903	11-134371	TUERCA	NUT	DADO	ÉCROU
8	RM865328A01	865328A01	SOPORTE TRANSOM Design II (OM815639+)	GIMBAL RING ASSEMBLY Design II (OM815639+)	SUPPORTI TRANSOM Design II (OM815639+)	FOURCHE DE DIRECTION Gen II (OM815639+)
9	REC98230A1	98230A1	EJE	SHAFT	ASSE	ARBRE
10	RM12-41721	12-41721	ARANDELA	WASHER	RONDELLA	RONDELLE
11	REC23-847637	23-847637	CASQUILLO	BUSING	BOCCOLA	BAGUE
12	REC77123	77123	TORNILLO ALPHA (-1998) (-OM815638)	ALPHA SCREW (-1998) (-OM815638)	VITE ALPHA (-1998) (-OM815638)	VIS Alpha (-1998) (-OM815638)
	REC10-86801	10-86801	TORNILLO ALPHA (1998+) (OM85639+)	ALPHA SCREW (1998+) (OM85639+)	VITE ALPHA (1998+) (OM85639+)	VIS Alpha (1998+) (OM815639+)
13	RM23-99352	23-99352	COJINETE	BEARING	CUSCINETTO	ROULEMENT
	REC806034A1	866200A01	PISTÓN DIRECCIÓN MODERNA (1991+) Plástico	NEWER POWER STEERING PISTON (1991+) Plastic	PISTONE IDRAULICO MODERNO (1991+) Plastica	VERIN DE DIRECTION MODERN (1991+) Plastique
14	RM806034A2	806034A2	PISTON DIRECCIÓN ANTIGUA (-1991) Metálico	OLDER POWER STEERING PISTON (-1991) Metal	PISTONE IDRAULICO VECCHIO (-1991) Metallo	VERIN DE DIRECTION ANCIEN (-1991) Métalique

CAMPANA TRANSOM
MC, MR1, ALPHA ONE,
ALPHA ONE GEN II

BELL HOUSING
MC, MR1, ALPHA ONE,
ALPHA ONE GEN II

CAMPANA TRANSOM
MC, MR1, ALPHA ONE,
ALPHA ONE GEN II

CASQUE
MC, MR1, ALPHA ONE,
ALPHA ONE GEN II

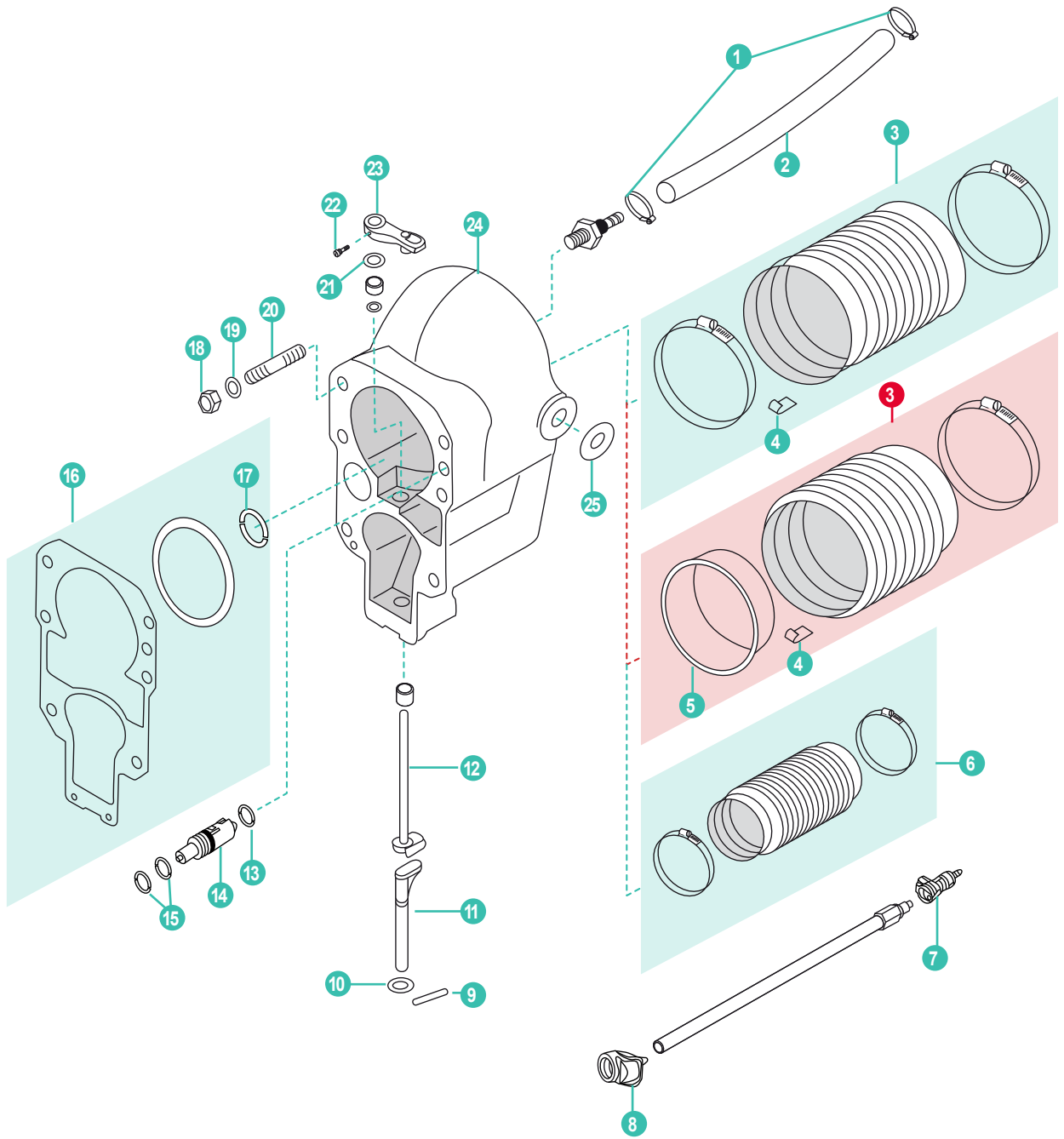

	REF	OEM				
1	REC54-815504412	54-815504412	ABRAZADERA	CLAMP	FASCETTA	COLLIER
2	REC32-4172533	32-4172533	TUBO AGUA Ø 3/4 137/8"L	WATER HOSE Ø 3/4 137/8"L	TUBO ACQUA Ø 3/4" 137/8"L	DURITE Ø 3/4" 137/8"L
	REC32-32461	32-32461	TUBO AGUA Ø 5/8 137/8"L	WATER HOSE Ø 5/8 137/8"L	TUBO ACQUA Ø 5/8" 137/8"L	DURITE Ø 5/8" 137/8"L
3	REC60932A4	60932A4	KIT FUELLE (3469428+) R/MR/ALPHA ONE	U-JOINT BELLOW (3469428+) KIT R/MR/ALPHA ONE	KIT CUFFIA (3469428+) R/MR/ALPHA ONE	KIT SOUFFLE (3469428+) R/MR/Alpha one
3	REC816431A1	816431A1	KIT FUELLE (Alpha one Gen II)	U-JOINT BELLOW KIT (Alpha one Gen II)	KIT CUFFIA (Alpha one Gen II)	KIT SOUFFLET (Alpha one Gen II)
4	REC54-86049	54-86049	CLIP FUELLE	GROUNDING CLIP	CLIP CUFFIA	CLIPS SOUFFLET
5	REC816607	816607	CASQUILLO FUELLE	BELLOW FLANGE RING	ANELLO	BAGUE
6	REC18654A1	18654A1	KIT FUELLE ESCAPE	U-JOINT BELLOW KIT	KIT CUFFIA DI SCARICO	KIT SOUFFLET ÉCHAPPEMENT
7	REC22-865417	22-865417	CONECTOR HEMBRA (Design II OM815639+)	FITTING FEMALE QUICK CONNECT (Design II OM815639+)	CONETTORE FEM (Design II OM815639+)	CONNECTEUR FEM (Design II OM815639+)
8	REC22-860382	22-860382	CONECTOR VELOCIMETRO	COUPLING ASSEMBLY SPEEDOMETER	CONNETTORE DEL TACHIMETRO	CONNECTEUR DE COMPTEUR DE VITESSE
9	REC18-32665	18-32665	PASADOR	COTTER PIN	CHIAVISTELLO	GOUPILLE
10	REC12-32666	12-32666	ARANDELA	WASHER	RONDELLA	RONDELLE
11	REC621041	621041	EJE INTERMEDIO	INTERMEDIATE SHIFT SHAFT	ASSE INTERMEDIO	ARBRE
	REC816685	816685	EJE CABLE CAMBIO (Alpha one Gen II)	UPPER SHIFT SHAFT (Alpha one Gen II)	ASSE CAMBIO (Alpha one Gen II)	ARBRE CÂBLE CHANGEMENT (Alpha one Gen II)
12	REC45589A3	45589A3	EJE CABLE CAMBIO (Alpha one Gen I)	UPPER SHIFT SHAFT (Alpha one Gen I)	ASSE CAMBIO (Alpha one Gen I)	ARBRE CÂBLE CHANGEMENT (Alpha one Gen I)
13	REC25-62705	25-62705	ANILLO	O-RING	O-RING	JOINT TORIQUE
14	REC18920A1	18920A1	VÁLVULA COMPLETA	VALVE ASSY	VALVOLA COMPLETA	SOUPAPE COMPLETE
15	REC25-48171	25-48171	ANILLO	O-RING	O-RING	JOINT TORIQUE
	REC27-94996Q2	27-94996Q2	KIT JUNTAS TRANSOM (Alpha one & Gen II)	GASKET KIT (Alpha one & Gen II)	KIT GUARNIZIONI TRANSOM (Alpha one & Gen II)	KIT JOINS (Alpha one & Gen II)
16	REC27-64818Q4	27-64818Q4	KIT JUNTAS TRANSOM (MC1)	GASKET KIT (MC1)	KIT GUARNIZIONI TRANSOM (MC1)	KIT JOINTS (MC1)
17	REC0307239	25-33504	ARO TÓRICO	O-RING	O-RING	JOINT TORIQUE
18	REC11-34933	11-134391	TUERCA (.4375-20)	NUT (.4375-20)	DADO (.4375-20)	ÉCROU (.4375-20)
19	REC12-45176	12-35935	ARANDELA (.435 x .875 x .105)	WASHER (.435 x .875 x .105)	RONDELLA (.435 x .875 x .105)	RONDELLE (.435 x .875 x .105)
20	REC16-59579	16-59579	TORNILLO	SCREW	VITE	VIS
21	REC12-39116	12-39116	JUNTA	GASKET	GUARNIZIONE	JOINT
22	REC10-45590	10-45590	TORNILLO CIERRE	SET SCREW	VITE	VIS
23	REC45518A3	45518A3	PASADOR	SHIFT ARM	CHIAVISTELLO	GOUPILLE
	RM42815A6	42815A6	CAMPANA TRANSOM Alpha one (1983-90)	BELL HOUSING Alpha one (1983-90)	CAMPANA TRANSOM Alpha one (1983-90)	CASQUE TRANSOM Alpha one (1983-90)
24	RM806031A2	806031A2	CAMPANA TRANSOM GEN II (1991+)	GEN II BELL HOUSING (1991+)	CAMPANA TRANSOM GEN II (1991+)	CASQUE TRANSOM GEN II (1991+)
25	REC12-72498	12-72498	ARANDELA	WASHER	RONDELLA	RONDELLE
26	RM53-87843	53-87843	CIRCLIP	CIRCLIP	CIRCLIP	CLIPS
27	REC23-806036A1	23-806036A1	KIT RETENES Alpha Gen II, (F094775+)	SHIFT SHAFT BUSING Alpha Gen II, (F094775+)	KIT TENUTE Alpha Gen II, (F094775+)	KIT JOINTS Alpha Gen II, (F094775+)
28	REC23-805041A2	23-805041A2	KIT RETENES R/MR, Alpha Gen II, (-F094774)	SHIFT SHAFT BUSING R/MR, Alpha Gen II, (-F094774)	KIT TENUTE R/MR, Alpha Gen II, (-F094774)	KIT JOINTS R/MR, Alpha Gen II, (-F094774)
29	REC45518T1	45518T1	KIT CAMBIO	SHIFT LEVER KIT	KIT CAMBIO	KIT CHANGEMENT
30	REC22-861150T02	22-861150A1	RACOR ACEITE	OIL RACORD	RACORDO OLIO	RACORD D'HUILE
31	RM22-861163	22-861163	RACOR ACEITE	OIL RACORD	RACORDO OLIO	RACORD D'HUILE



TRANSOM BRAVO

GIMBAL HOUSING BRAVO

TRANSOM BRAVO

TRANSOM BRAVO

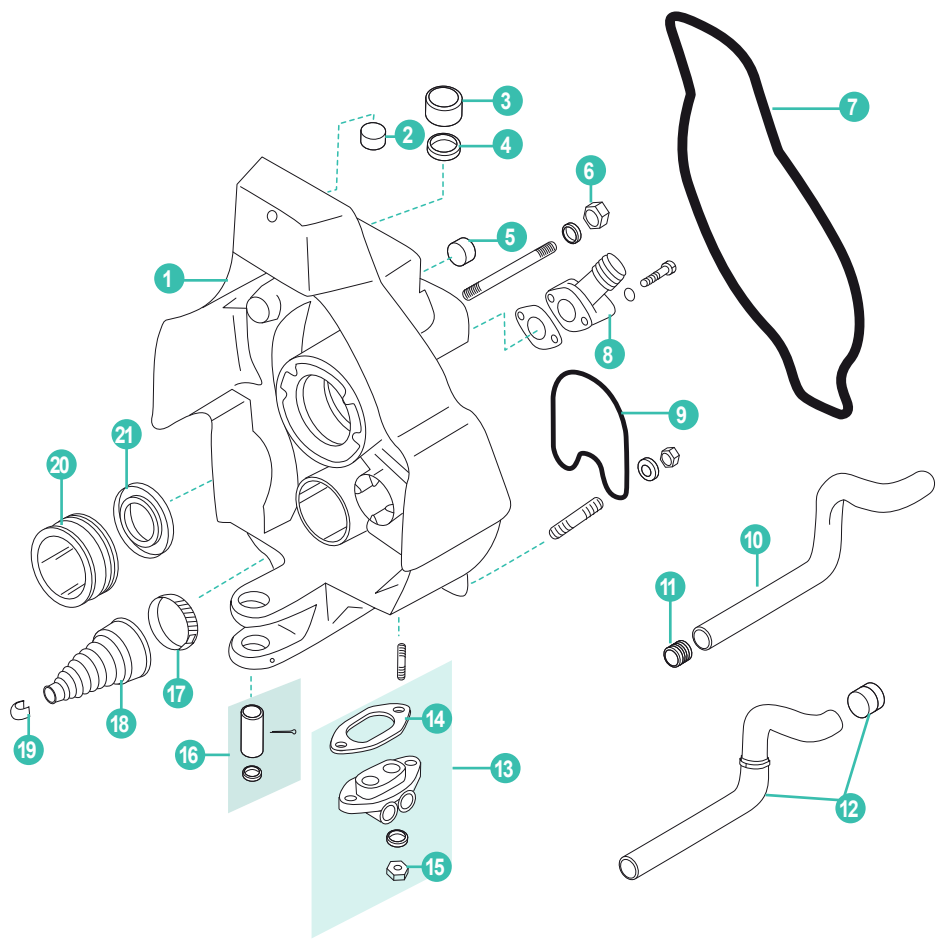
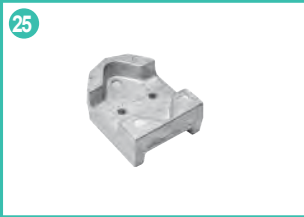

	REF	OEM				
1	RM43881A17	43881A17	CARCASA	GIMBAL HOUSING ASSY.	CARCASSA	PLATINE
2	RM23-98356	23-98356	CASQUILLO SUPERIOR	UPPER BUSHING	BOCCOLA SUPERIORE	BAGUE SUPÉRIEURE
3	RM23-983571	23-983571	CASQUILLO INFERIOR	BUSHING - LOWER	BOCCOLA INFERIORE	BAGUE IN'FÉRIEUR
4	REC26-8M2005029	26-416071	RETÉN	OIL SEAL	PARAOLIO	JOINT D'HUILE
5	REC22-428611	22-428611	TAPÓN	PLUG	TAPPO	BOUCHON
6	REC11-34933	11-34933	TUERCA	NUT	DADO	ÉCROU
7	REC43713	43713	JUNTA TRANSOM	TRANSOM SEAL	GUARNIZIONE TRANSOM	JOINT TRANSOM
8	RM22-43828	22-43828T	CONECTOR (-OW099999)	CONNECTOR (-OW099999)	PIPETTA (-OW099999)	CONNECTEUR (-OW099999)
	RM865470	865470	CONECTOR (OW100000+)	CONNECTOR (OW100000+)	PIPETTA (OW100000+)	CONNECTEUR (OW100000+)
9	REC41802	41802	RETÉN	SEAL	TENUTA	JOINT D'HUILE
10	REC32-43437	32-43437	TUBO AGUA DESIGN I	WATER HOSE DESIGN I	TUBO ACQUA DESIGN I	DURITE DESIGN I
11	REC41674T	41674T	CASQUILLO	INSERT	BOCCOLA	BAGUE
12	REC8M0062102	32-8M0062102	TUBO DE AGUA DESIGN II	WATER HOSE DESIGN II	TUBO ACQUA DESIGN II	DURITE DESIGN II
13	REC8M0080805	8M0080805	KIT CONECTOR	CONNECTOR KIT	CONNETTORE	KIT CONECTEUR
14	REC27-988231	27-988231	JUNTA	GASKET	GUARNIZIONE	JOINT
15	REC11-8267089	11-8267089	TUERCA	NUT	DADO	ÉCROU
16	REC17-8M0073409	17-8M0073409	KIT PIN	PIN SET	KIT SPINOTTO	KIT GOUPILLE
17	REC54-815504320	54-815504320	ABRAZADERA	CLAMP	FASCETTA	COLLIER
18	REC74639Q02	74639Q02	FUELLE CABLE CAMBIO	SHIFT CABLE BELLOW	CUFFIA CAMBIO	SOUFFLET CÂBRE CHANGEMENT
19	REC54-38863	54-38863	ABRAZADERA	CLAMP	FASCETTA	COLLIER
20	REC30-879194A01	879194A01 Et A02	COJINETE	GIMBAL BEARING	CUSCINETTO	ROULEMENT
21	REC26-88416	26-88416	RETÉN ACEITE	OIL SEAL	PARAOLIO	JOIT D'HUILE
22	REC22-88847A1	22-88847A1	KIT TUERCA Y TAPONES	PLUG KIT	KIT DADO TAPPO	KIT ÉCROU ET BOUCHON
23	REC8M0080805	8M0080805	KIT CONECTOR TRIM	TRIM CONNECTOR KIT	KIT CONNETTORE TRIM	KIT CONNECTEUR TRIM
24	REC30-879194A01	30-879194A01	COJINETE	BEARING	CUSCINETTO	ROULEMENT
25	CM821631	821631Q	ÁNODO ZN	ANODE ZN	ANODO ZN	ANODE ZN
	CM821631A	821631Q	ÁNODO AL	ANODE AL	ANODO AL	ANODE AL

CAMPANA BRAVO

BELL HOUSING BRAVO

CAMPANA BRAVO

CASQUE BRAVO



REF
RM53-87843

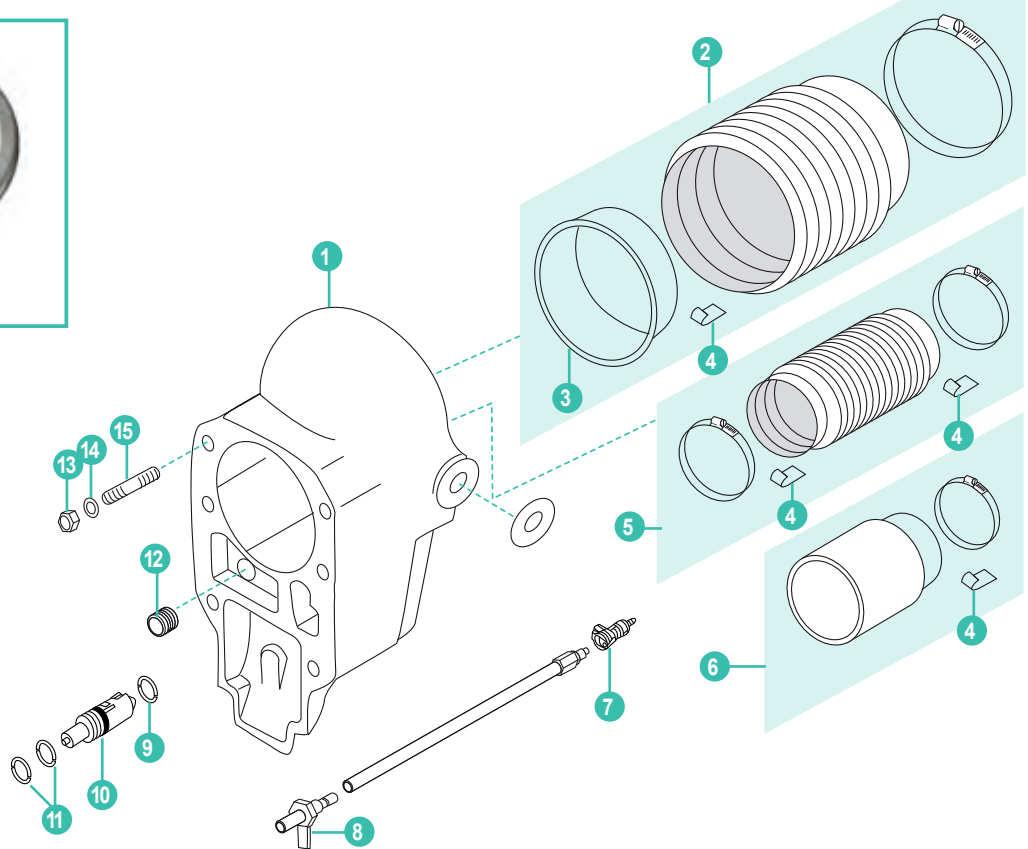

REF
REC16755Q1



REF
REC23-861209A1



REF
REC22-861150T02



REF
RM22-861163

	REF	OEM			
1	RM41646A9	41646A9	CAMPANA Bravo I, II, III (-2A514802)	Bravo I, II, III BELL HOUSING (-2A514802)	CAMPANA Bravo I, II, III (-2A514802)
2	REC86840A05	86840A05	FUELLE TRANSON	U-JOINT BELLOW	CUFFIA TRANSON
3	REC862209	862209	CASQUILLO FUELLE	BELLOW FLANGE RING	ANELLO
4	REC54-86049	54-86049	CLIP	CLIP	CLIP
5	REC18654A1	18654A1	FUELLE ESCAPE	EXHAUST BELLOW	CUFFIA SCARICO
6	REC78458A1	78458A1	TUBO ESCAPE	EXHAUST TUBE	TUBO DI SCARICO
7	REC22-865417	22-865417	CONECTOR	FITTING	CONETTORE
8	REC815303T	815303T	ADAPTADOR	ADAPTER	ADATTATORE
9	REC25-62705	25-62705	ARO	O-RING	ANELLO
10	REC18920A1	18920A1	VÁLVULA COMPLETA	VALVE ASSEMBLY	VALVOLA COMPLETA
11	REC25-48171	25-48171	ARO	O-RING	ANELLO
12	REC41674T	41674T	KIT CASQUILLO	INSERT	KIT GHIERA
13	REC11-34933	11-859116	CIERRE	LOCKNUT	CHIUSURA
14	REC12-45176	12-35935	ARANDELA	WASHER	RONDELLA
15	REC16-59579	16-59579	TORNILLO	SCREW	VITE
16	RM53-87843	53-87843	CIRCLIP	CIRCLIP	CIRCLIP
17	REC22-861150T02	22-861150A1	RACOR ACEITE	OIL RACORD	RACORDO OLIO
18	RM22-861163	22-861163	RACOR ACEITE	OIL RACORD	RACORDO OLIO
19	REC16755Q1	16755Q1	KIT JUNTAS Bravo Et Blackhawk	GASKET SET Bravo Et Blackhawk	KIT GUARNIZIONE Bravo Et Blackhawk
20	REC23-861209A1	23-861209A1	KIT RETENES	SHIFT SHAFT BUSING	KIT TENUTE
					CASQUE TRANSOM Bravo I, II, III (-2A514802)
					SOUFFLET
					BAGUE
					CLIPS
					SOUFFLET ÉCHAPPEMENT
					DURITE ÉCHAPPEMENT
					CONNECTEUR
					ADAPTATEUR
					JOINT TORIQUE
					SOUPAPE COMPLET
					JOINT TORIQUE
					KIT BAGUE
					ECROU INOX
					RONDELLE
					VIS
					CLIPS
					RACCORD HUILE
					RACCORD HUILE
					KIT JOINTS Bravo et Blackhawk
					KIT JOINTS D'HUILE

SOPORTE TRANSOM BRAVO I, II, III

GIMBAL HOUSING RING ASSEMBLY. BRAVO I, II, III

SUPPORTO TRANSOM BRAVO I, II, III

SUPPORT TRANSOM BRAVO I, II, III

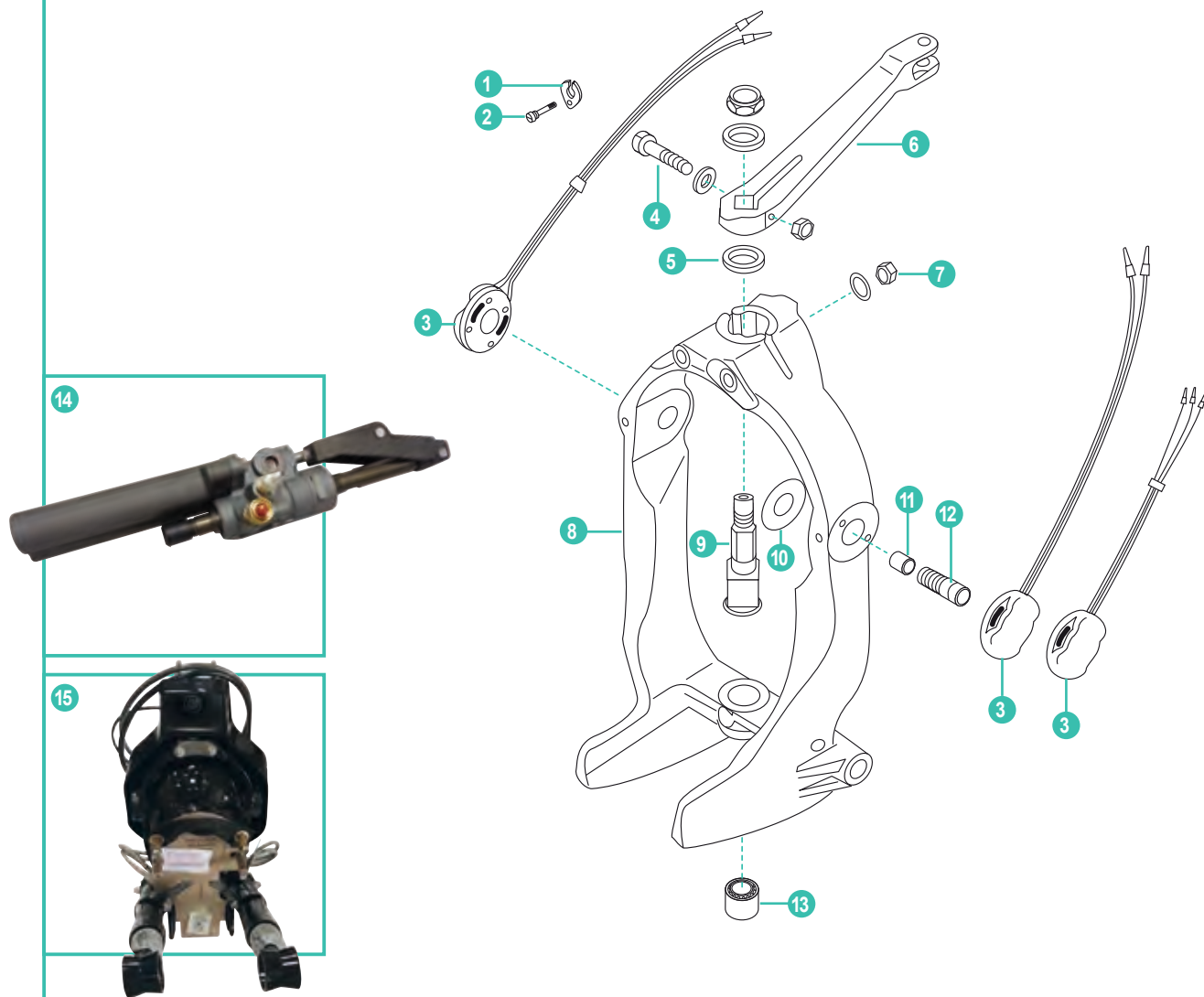

	REF	OEM				
1	RM54-12078	54-12078	ABRAZADERA	CLAMP	FASCETTA	COLLIER
2	RM10-28635	10-28635	TORNILLO SUJECCIÓN	SCREW	VITE	VIS
3	REC805320A03	805320A03	KIT SENSORES TRIM	TRIM SENSOR KIT	KIT SENSORI TRIM	KIT SONDES TRIM
	REC8M0095310	8M0095310	KIT SENSOR TRIM DIGITAL	TRIM SENSOR KIT, DIGITAL	KIT SENSORI TRIM, DIGITAL	KIT SONDES TRIM DIGITAL
4	RM10-807204	10-807204	TORNILLO	SCREW	VITE	VIS
5	RM12-98548	12-98548	ARANDELA	WASHER	RONDELLA	RONDELLE
6	RM866322A01	866322A01	BIELA DIRECCIÓN	LEVER ASSY	BIELLA STERZO	PIVOT DE DIRECTION
7	REC11-862903	11-134371	TUERCA	NUT	DADO	ÉCROU
8	RM8M0062440	8M0062440	SOPORTE TRANSOM	GIMBAL RING ASSEMBLY	SUPPORTO TRANSOM	FOURCHE DE DIRECTION
9	REC98230A1	98230A1	EJE	SHAFT	ASSE	ARBRE
10	RM12-41721	12-41721	ARANDELA	WASHER	RONDELLA	RONDELLE
11	REC23-847637	23-847637	CASQUILLO	BUSING	BOCCOLA	BAGUE
12	REC10-86801	10-86801	TORNILLO (1998+)	SCREW (1998+)	VITE (1998+)	VIS (1998+)
13	RM23-847638	23-847638	COJINETE MAGNUM	BEARING MAGNUM	CUSCINETTO MAGNUM	ROULEMENT MAGNUM
	RM23-99352	23-99352	COJINETE ESTÁNDAR	BEARING STANDARD	CUSCINETTO STANDARD	ROULEMENT STANDARD
14	REC806034A1	866200A01	PISTÓN DIRECCIÓN Moderno (1994+) Plástico	NEWER POWER STEERING PISTON (1994+) Plastic	PISTONE IDRAULICO Moderno (1994+) Plastica	PISTON DIRECTION moderne (1994+) plastique
	RM806034A2	806034A2	PISTÓN DIRECCIÓN (1983-1993) Metálico	OLDER POWER STEERING PISTON (1983-1993) Metalic	PISTONE IDRAULICO vecchio (1983-1993) Metallo	PISTONE DIRECTION ancien (1983-93) Métalique
15	TRANSONBRAVO	6-6211002NZ 6-6311002NZ	TRANSOM COMPLETO	TRANSOM ASSEMBLY	TRANSOM COMPLETO	TRANSOM COMPLET

COMPONENTES TRANSOM

TRANSOM COMPONENTS

COMPONENTI TRANSOM

COMPONENTS DU TRANSOM

KITS DE JUNTAS

GASKET SET

KIT GUARNIZIONI

KIT JOINTS

REF	OEM	
REC27-54014Q1	27-54014Q1	TR/TRS



REF	OEM	
REC27-64818Q4	27-64818Q4	MC1/120 - 260

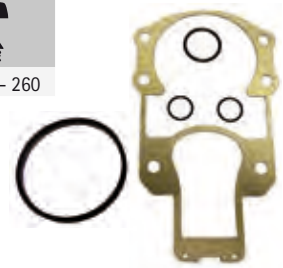

REF	OEM	
REC87580		TR/TRS

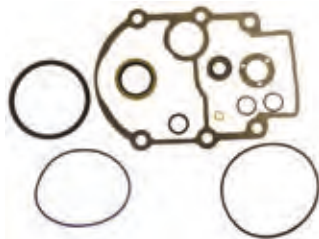

REF	OEM	
REC27-94996Q2	27-94996Q2	MC1/R/MR Alpha One/Gen II

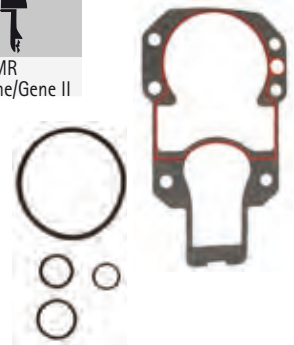

REF	OEM	
REC16755Q1	16755Q1	BRAVO



KIT FUELLE

U-JPINT BELLOWS KIT

KIT CUFFIE

KIT SOUFFLET

REF	OEM	
REC60932A4	60932A4	1/R/Alpha One
CEF500516K	60932A1	(3469428+)



REF	OEM	
REC86840A05	8M0062406	Bravo & Blackhawk
CEF500509K	86840A3	
	86840A05	



REF	OEM	
REC36223A2	36223A2	Colas antiguas
	36223	Old styles drives
	36223A1	Piedi vecchio
CEF500522K	36223A1	Embases anciennes
		(-3443920)



REF	OEM	
REC816431A1	816431A1	Alpha One Gen II
CEF500515K		



KIT FUELLE CABLE CAMBIO

SHIFT CABLE BELLOW KIT

KIT CUFFIA CAMBIO

KIT SOUFFLET CHANGEMENT

REF	OEM	
REC74639Q02	74639Q02	ALPHA & BRAVO
CEF500513K		



CLIP FUELLE **BELLOW CLIP** **CLIP CUFFIE** **CLIPS**

REF	OEM
REC54-86049	54-86049



ABRAZADERA FUELLE CAMBIO **SHIFT CABLE BELLOW CLAMP** **FASCETTA CUFFIE CAMBIO** **COLLIER SOUFFLET CHANGEMENT**

REF	OEM	
REC54-38863	54-38863	REC74639Q02



REF	OEM	
REC54-815504320	54-815504320	REC74639Q02



FUELLE DE ESCAPE **EXHAUST BELLOWS** **CUFFIE DI SCARICO** **SOUFFLET D'ÉCHAPPEMENT**

REF	OEM	
REC78458A1	78458A1	Bravo I, II & III
CEF500520K	78458	



REF	OEM	Ø IN.
REC18654A1	18654A1	Alpha & Bravo
CEF500512K	32734	
	32734A3	



CAMBIO **SHIFT** **CAMBIO** **CHANGEMENT**

CABLE **CABLE** **CAVO** **CÂBLE**

REF	
REC21470	MCM Modelos modernos Newer models Modello moderno Modeles modernes



REF	OEM	
REC865436A02	865436A02	MCM Modelos modernos Newer models Modello moderno Modeles modernes
RM19543A10	ORIGINAL	

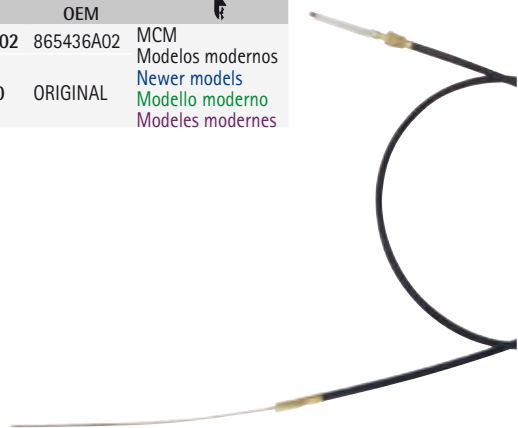

REF	OEM	
REC865437A02	865437A02	Bravo I, II, III



KIT CABLE CAMBIO **SHIFT CABLE ASSY KIT** **KIT CAVO CAMBIO** **KIT CÂBLES CHANGEMENT**

REF	OEM	
REC865436A03		MC1/R/MR/Alpha One/Gen II



REF	OEM	
REC815471T1	815471T1	Bravo I, II, III



CABLES DE DIRECCIÓN

STEERING CABLE

CAVI DI TIMONERIA

CÂBLES DE COMMANDE

GEN I

Mercury, Mercruiser, Mariner

REF	OEM	
PREKM63706	8M0082479	6' / 1,80 m
PREKM63707	8M0082480	7' / 2,10 m
PREKM63708	8M0082481	8' / 2,45 m
PREKM63709	8M0082482	9' / 2,75 m
PREKM63710	8M0082483	10' / 3,05 m
PREKM63711	8M0082484	11' / 3,35 m
PREKM63712	8M0082485	12' / 3,65 m
PREKM63713	8M0082486	13' / 3,95 m
PREKM63714	8M0082487	14' / 4,25 m
PREKM63715	8M0082488	15' / 4,60 m
PREKM63716	8M0082489	16' / 4,90 m
PREKM63717	8M0082490	17' / 5,20 m
PREKM63718	8M0082491	18' / 5,50 m
PREKM63719	8M0082492	19' / 5,80 m
PREKM63720	8M0082493	20' / 6,10 m
PREKM63721	8M0082494	21' / 6,40 m
PREKM63722	8M0082495	22' / 6,70 m
PREKM63723	8M0082496	23' / 7,00 m
PREKM63724	8M0082497	24' / 7,30 m



GEN II

Mercury 4000 / 4500 GEN II PLATINUM

REF	OEM	
PRE53006	8M0082529	6' / 1,80 m
PRE53007	8M0082530	7' / 2,10 m
PRE53008	8M0082531	8' / 2,45 m
PRE53009	8M0082532	9' / 2,75 m
PRE53010	8M0082533	10' / 3,05 m
PRE53011	8M0082534	11' / 3,35 m
PRE53012	8M0082535	12' / 3,65 m
PRE53013	8M0082536	13' / 3,95 m
PRE53014	8M0082537	14' / 4,25 m
PRE53015	8M0082538	15' / 4,60 m
PRE53016	8M0082539	16' / 4,90 m
PRE53017	8M0082540	17' / 5,20 m
PRE53018	8M0082541	18' / 5,50 m
PRE53019	8M0082542	19' / 5,80 m
PRE53020	8M0082543	20' / 6,10 m
PRE53021	8M0082544	21' / 6,40 m
PRE53022	8M0082545	22' / 6,70 m
PRE53023	8M0082546	23' / 7,00 m
PRE53024	8M0082547	24' / 7,30 m



3300C

Recorrido trabajo: 76 mm.
Rosca 10-32"

Travel 3"
Threaded 10-32"

Estensione: 76 mm
Filetto 10-32"

Course: 76 mm.
Fil 10-32"

REF	RO	
PRE3300C05	8M0082577	5' / 1,50 m
PRE3300C06	8M0082578	6' / 1,80 m
PRE3300C07	8M0082579	7' / 2,10 m
PRE3300C08	8M0082580	8' / 2,45 m
PRE3300C09	8M0082581	9' / 2,75 m
PRE3300C10	8M0082582	10' / 3,05 m
PRE3300C11	8M0082583	11' / 3,35 m
PRE3300C12	8M0082584	12' / 3,65 m
PRE3300C13	8M0082585	13' / 3,95 m
PRE3300C14	8M0082586	14' / 4,25 m
PRE3300C15	8M0082587	15' / 4,60 m
PRE3300C16	8M0082588	16' / 4,90 m
PRE3300C17	8M0082589	17' / 5,20 m
PRE3300C18	8M0082590	18' / 5,50 m
PRE3300C19	8M0082591	19' / 5,80 m
PRE3300C20	8M0082592	20' / 6,10 m
PRE3300C21	8M0082593	21' / 6,40 m
PRE3300C22	8M0082594	22' / 6,70 m
PRE3300C23	8M0082595	23' / 7,00 m
PRE3300C24	8M0082596	24' / 7,30 m

REF	RO	
PRE3300C25	8M0082597	25' / 7,60 m
PRE3300C26	8M0082598	26' / 7,90 m
PRE3300C27	8M0082599	27' / 8,25 m
PRE3300C28	8M0082600	28' / 8,55 m
PRE3300C29	8M0082601	29' / 8,85 m
PRE3300C30	8M0082602	30' / 9,15 m
PRE3300C31	8M0082603	31' / 9,50 m
PRE3300C32		32' / 9,75 m
PRE3300C33		33' / 10,00 m
PRE3300C34	8M0082604	34' / 10,35 m
PRE3300C35		35' / 10,65 m
PRE3300C36	8M0082605	36' / 11,00 m
PRE3300C38	8M0082606	38' / 11,50 m
PRE3300C40		40' / 12,10 m
PRE3300C42		42' / 12,70 m
PRE3300C44		44' / 13,30 m
PRE3300C46		46' / 14,00 m
PRE3300C48		48' / 14,50 m
PRE3300C50		50' / 15,00 m

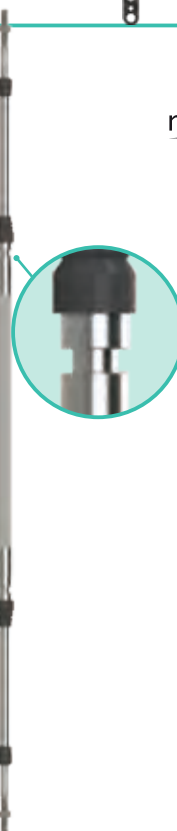
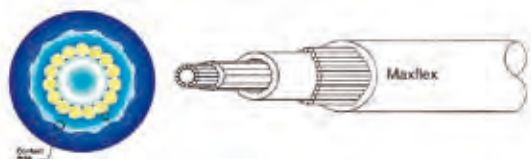

REF
PRE30107
PRE30212



PRE30107





PRE30212

ACTUADOR CAMBIO ELECTRONICO

DIGITAL SHIFT ACTUATOR

ATTUATORE DEL CAMBIO

ACTIONNEUR DE CHANGEMENT

REF	OEM		
REC879194T46	879194T46	3.0, 8.1, 8.2 496MAG, 5.0, 5.7, 6.2, 4.5	TDI 4.2 CMD QSD 2.0 CMD QSD 2.8 CMD QSD 4.2 2.0LEI/ES



new

EJE CABLE CAMBIO SUPERIOR

UPPER SHIFT SHAFT

ALBERINO SUPERIORE CAMBIO

ARBRE SUPERIEUR

REF	OEM	
REC45589A3	45589A3	MC-1/R/MR/Alpha One



REF	OEM	
REC816685	816685	Alpha One Gen II



REF	OEM	
REC12711	12711	Bravo I, II & III



EJE CABLE CAMBIO INTERMEDIO

INTERMEDIATE SHIFT SHAFT

ALBERINO INTERMEDIO CAMBIO

ARBRE INTERMÉDIAIRE DE CHANGEMENT

REF	OEM	
REC621041	621041	MC-1/R/MR/Alpha One



TORNILLO

SCREW

VITE

VIS

REF	OEM	
REC10-45590	10-45590	MC-1 / R / MR
REC10-31700	10-31700	Alpha One / Gen II



REC10-45590



REC10-31700

PASADOR

PIN

SPINOTTO

PIN

REF	OEM	
REC45518A3	45518A3	MC-1 / R / MR Alpha One / Gen II



KIT CAMBIO

SHIFT LEVER KIT

KIT CAMBIO

KIT CHANGEMENT

REF	OEM	
REC45518T1	45518T1	MC-1/R/MR Alpha One / Gen II



ACOPLE CABLE

CABLE SLIDE

ACCOPPIO CAVO

KIT ATTACHE CABLE

REF	OEM	
REC8507522	8507522	MC-1 / R / MR Alpha One / Gen II



KIT RETÉN

SEAL KIT

KIT TENUTE

KIT JOINTS D'HUILE

REF	OEM	
REC23-806036A1	23-806036A1	Alpha One Gen II (F094775+)

REF	OEM	
REC23-861209A1	23-861209A1	Bravo I, II & III

REF	OEM	
REC23-805041A2	23-805041A2	MC-1 / R/ MR Alpha One / Gen II

GUÍA CABLE

CABLE GUIDE

GUIDA CAVO

GUIDE CÂBLE

	REF	OEM
KIT	REC02644	
ANCLAJE CABLE CABLE ANCHOR	REC43436	43436
FERMA CAVO ANCORAGE CABLE TORNILLO SCREW VITE VIS	REC10-20518	10-20518



SOPORTE MOTOR

ENGINE MOUNT SCREW

SUPPORTI MOTORE

SUPPORT MOTEUR

REF	OEM	
GS38105	814263A1	19 mm = 3/4"
GS38122	35852	16 mm = 5/8"



ACOPLAMIENTOS MOTOR

ENGINE COUPLER ASSEMBLIES

ACCOPPIAMENTO MOTORE

ACCOUPLLEMENT MOTEUR

REF	OEM	
REC69354A2	69354A2	470, 485 (42208730-6218036) (1976-82)

REF	OEM	
REC861523A9	861523A9	5.7, 7.4, 454 Magnum Et 502 BRAVO

REF	OEM	
REC97432A2	97432A2	165, 170, 470, 180, 190, 488, 3.7LX, 3.7L (6170297+) (1983-89)

REF	OEM	
REC59826A3	59826A3	FORD

Se usa en todos los Chevys antiguos en los que el retén trasero del cigüeñal es de dos piezas.

Used on all older Chevy engines with 2 piece rear main seals.

Si usa in tutti i Chevy vecchio con paraolio posteriore in 2 pz. 4 cil V6 e V8.

Utilisé sur toutes les anciennes Chevy où le joint arrière du vilebrequin est en deux parties.

REF	OEM	
REC76850A2	76850A2	GM MR / ALPHA / BRAVO



Utilizado al reemplazar V6 o V8, 2 piezas de retén trasero con perno de cigüeñal de 3 1/2", retén trasero de 1 pieza con perno de 3".

Used when replacing V6 or V8, 2 pieces rear main seal with 3 1/2" crankshaft bolt pattern to a newer 1 piece rear main seal engine with 3" bolt pattern.

Utilizzato per sostituire V6 o V8, paraolio posteriore in 2 pezzi con perno dell'albero motore con 3 1/2", perno posteriore de 1 pezzo da 3".

Utilisé lors du remplacement d'un V6 ou d'un V8, support arrière en 2 pièces avec boulon de vilebrequin de 3 1/2", support arrière en 1 pièce avec boulon de 3".

REF	OEM	
REC14505A2	14505A2	V6, V8



REF	OEM	
REC18643A7	18643A7	V6 Et V8 Con volante grande 14" For engines with 14" flywheel Con volano grande 14" Avec volant grand 14"



REF	OEM	
REC12632A7	12632A7	4L Con volante pequeño 12 3/4" For engines with 12 3/4" flywheel Con volano piccolo 12 3/4" Avec volant petit 12 3/4"



SILEMBLOCK

REF	OEM				
REC23-99322	23-99322	ESPACIADOR	SPACER	DISTANZIALE	CALE
REC23-99299	23-99299	ESPACIADOR	SPACER	DISTANZIALE	CALE
REC12-32834	12-32834	ARANDELA FIBRA	FIBRE WASHER	RONDELLA FIBRA	RONDELLE FIBRE
REC12-35777	12-35777	ARANDELA	WASHER	RONDELLA	RONDELLE
REC10-97934	10-97934	TORNILLO	SCREW	VITE	VIS
REC11-863332	11-863332	CIERRE	LOCK	CHIUSSURA	ÉCROU
REC13-33734	13-33734	MUELLE	SPRING	MOLLA	RESSORT



KITS SILEMBLOCK

REF	OEM
REC865329A02	865329A02

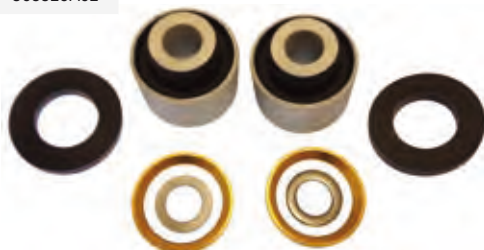

REF	OEM
REC10-97934A1	10-97934A1



REF	OEM
REC21811	



POWER TRIM

120-140-165-228-250-260-470-485-888-898

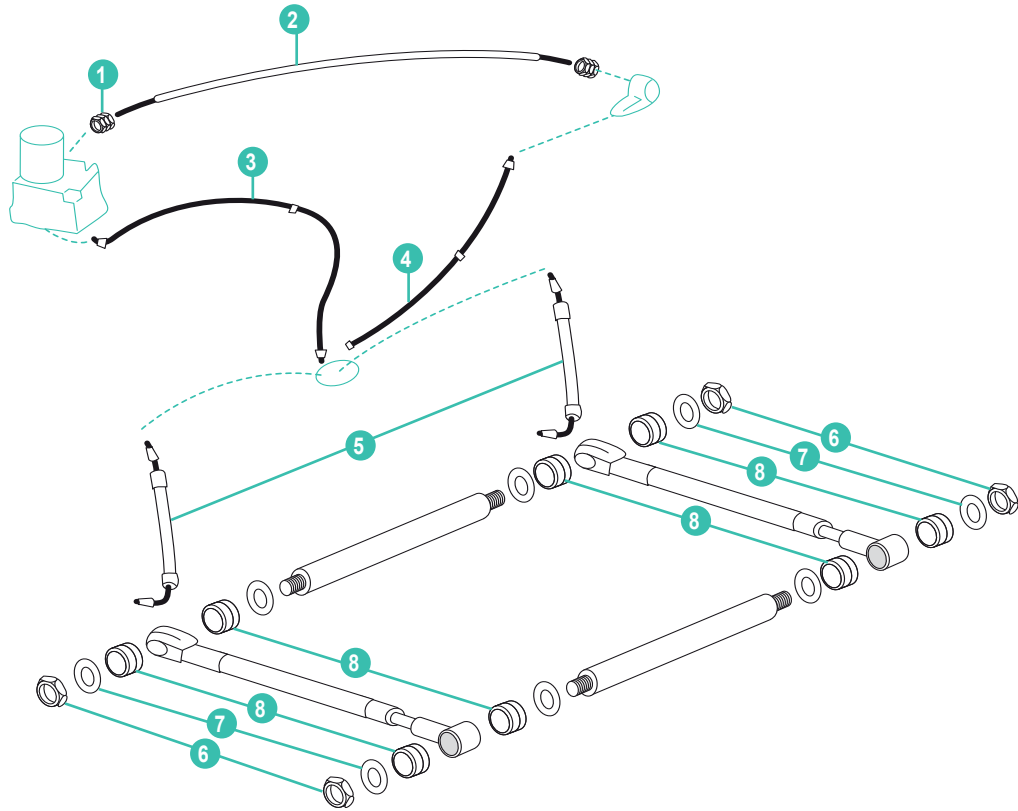

	REF	OEM				
1	RM22-49718	22-49718	TUERCA TUBO	NUT HOSE	DADO TUBO	ÉCROU
2	REC32-58432A2	32-58432A2	LATIGUILLO TRIM (V8)	TRIM HOSE ASSEMBLY (V8)	TUBO TRIM (V8)	FLEXIBLE DE VÉRIN DE TRIM (V8)
3	REC32-55816	33-55816	LATIGUILLO TRIM (INLINE)	TRIM HOSE (INLINE)	TUBO TRIM (INLINE)	FLEXIBLE DE VÉRIN DE TRIM (INLINE)
	REC32-59841	32-59841	LATIGUILLO TRIM (Conector --> bomba) V8	TRIM HOSE (Connector --> pump) V8	TUBO TRIM (Connettore --> pompa) V8	FLEXIBLE DE VÉRIN DE TRIM (Conecteur --> pompe) V8
4	REC32-59842	32-59842	LATIGUILLO TRIM	TRIM HOSE	TUBO TRIM	FLEXIBLE DE VÉRIN DE TRIM
5	REC32-86036	32-86036	LATIGUILLO TRIM	TRIM HOSE	TUBO TRIM	FLEXIBLE DE VÉRIN DE TRIM
6	REC11-862903	82671013	TUERCA ACERO INOX	LOCK NUT	DADO ACCIAIO INOX	ÉCROU INOX
7	REC12-46765	12-46765	ARANDELA	WASHER	RONDELLA	RONDELLE
8	REC23-89574	23-89574	ADAPTADOR GOMA	POWER TRIM RAM BUSHING	ADATTATORE IN GOMMA	BAGUE POWER TRIM
9	REC21990	KIT REPARACIÓN CILINDRO POWER TRIM 120, 140, 160, 165, 888, 898, 228, 225-S, 233, 250, 260, 470, 485	POWER TRIM CYLINDER SERVICE KIT 120, 140, 160, 165, 888, 898, 228, 225-S, 233, 250, 260, 470, 485	POWER TRIM CYLINDER SERVICE KIT 120, 140, 160, 165, 888, 898, 228, 225-S, 233, 250, 260, 470, 485	KIT RIPARAZIONE CILINDRO POWER TRIM 120, 140, 160, 165, 888, 898, 228, 225-S, 233, 250, 260, 470, 485	KIT REPARATION VERIN DE TRIM 120, 140, 160, 165, 888, 898, 228, 225-S, 233, 250, 260, 470, 485
10	REC21390	KIT EJE SUJECCIÓN POWER TRIM para colas antiguas con gruesos pequeños en el eje de sujección delantero. MC1 120-260	POWER TRIM RAM BUSHING KIT for front anchor pin on early mercruisers with small rubber bushings. MC1 120-260	POWER TRIM RAM BUSHING KIT for front anchor pin on early mercruisers with small rubber bushings. MC1 120-260	KIT POWER TRIM. per vecchie piedi con piccoli spessori sull'asse di fissaggio anteriore MC1 120-260	KIT AXE VERIN DE TRIM, pour les vieilles embases avec de petites épaisseurs sur l'essieu avant. MC1 120-260
	REC21310					

R/MR/ALPHA ONE (1983-90)



REF
REC8M0080805



REF
REC87399A2



REF
REC88035

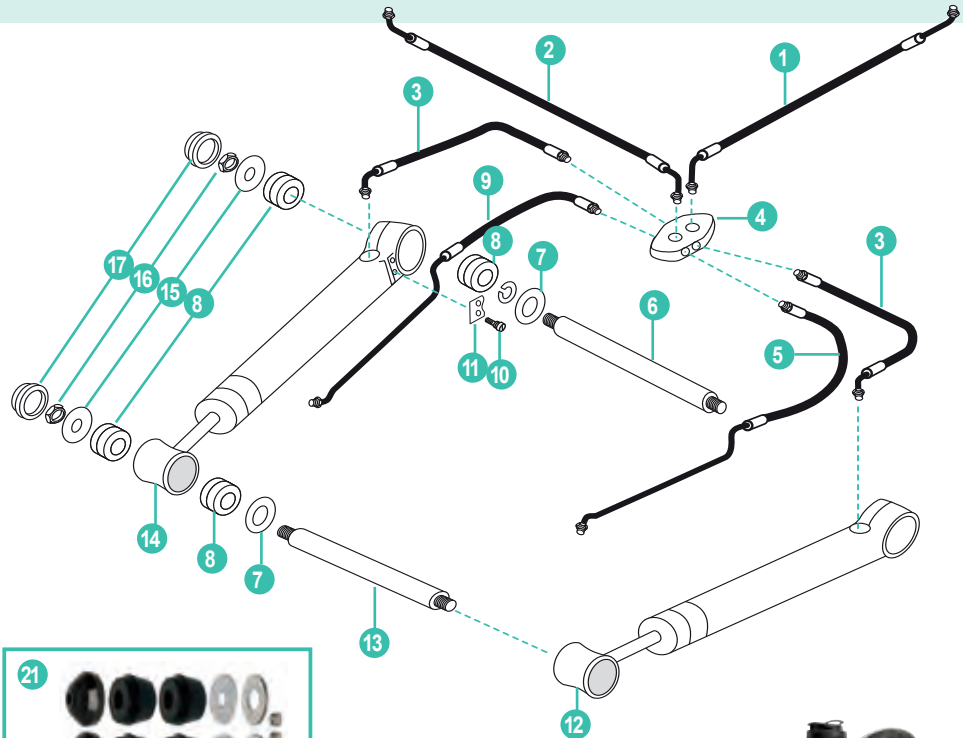

EJE RAM ASSE ARBRE
REF REC21380 23 cm
REC21370 30 cm



	REF	OEM				
1	REC32-861128	32-861128	LATIGUILLO TRIM (-OW099999)	TRIM HOSE (-OW099999)	TUBO TRIM (-OW099999)	FLEXIBLE DE TRIM (-OW099999)
2	REC32-861127	32-861127	LATIGUILLO TRIM (-OW099999)	TRIM HOSE (-OW099999)	TUBO TRIM (-OW099999)	FLEXIBLE DE TRIM (-OW099999)
3	REC32-99904	32-99904Q	LATIGUILLO TRIM	TRIM HOSE	TUBO TRIM	FLEXIBLE DE TRIM
4	REC8M0080805	8M0080805	KIT CONECTOR	TRIM CONNECTOR KIT	KIT CONNETTORE	KIT CONNECTEUR
5	REC32-864589	32-864589	LATIGUILLO PARA REC98704A3	TRIM HOSE FOR REC98704A3	TUBO TRIM PER REC98704A3	FLEXIBLE DE TRIM pour REC98704A3
6	REC32-864960	32-864960	LATIGUILLO PARA REC14034A3	TRIM HOSE FOR REC14034A3	TUBO TRIM PER REC14034A3	FLEXIBLE DE TRIM pour REC14034A3
7	REC17-14873A1	17-14873A1	KIT EJE SUJECCION (30 cm)	RAM BUSHING KIT (30 cm)	KIT ASSE (30 cm)	KIT ARBRE FIXATION VERIN (30 cm)
8	REC12-85058	12-85058	ARANDELA	WASHER	RONDELLA	RONDELLE
9	REC23-99291	23-99291T	ADAPTADOR GOMA	BALL GEAR NUT	ADATTATORE IN GOMMA	BAGUE
10	REC32-864588	32-864588	LATIGUILLO para REC98703A3	TRIM HOSE for REC98703A3	TUBO TRIM per REC98703A3	FLEXIBLE DE TRIM pour REC98704A3
11	REC32-864959	32-864959	LATIGUILLO para REC14035A3	TRIM HOSE for REC14035A3	TUBO TRIM per REC14035A3	FLEXIBLE DE TRIM pour REC14034A3
12	REC10-85486	10-85486	TORNILLO	SCREW	VITE	VIS
13	REC85060	85060	SUJECCIÓN TUBO	PLATE	SUPPORTO TUBO	PLAQUE SUPPORT
14	REC98704A3	98704A3	BRAZO TRIM ESTRIBOR (395 mm)	TRIM CYLINDER STBD (395 mm)	PISTONE TRIM TRIBORDO (395 mm)	VERIN DE TRIM TRIBORD (395 mm)
15	REC14034A3	14034A3	BRAZO TRIM ESTRIBOR (411 mm) Negro	TRIM CYLINDER STBD (411 mm) Black	PISTONE TRIM TRIBORDO (411 mm) Nero	VERIN DE TRIM TRIBORD (411 mm) Noir
16	REC17-14872A1	17-14872A1	KIT EJE SUJECCION (23 cm)	RAM BUSHING KIT (23 cm)	KIT ASSE SOGGEZIONE (23 cm)	KIT ARBRE FIXATION (23 cm)
17	REC98703A3	98703A3	BRAZO TRIM BABOR (395 mm)	TRIM CYLINDER PORT (395 mm)	PISTONE TRIM BABORDO (395 mm)	VERIN DE TRIM BABORD (395 mm)
18	REC14035A3	14035A3	BRAZO TRIM BABOR (411 mm) Negro	TRIM CYLINDER PORT (411 mm) Black	PISTONE TRIM BABORDO (411 mm) Nero	VERIN DE TRIM BABORD (411 mm) Noir
19	REC12-44163	12-44163	ARANDELA	WASHER	RONDELLA	RONDELLE
20	REC11-34933	11-859116	TUERCA ACERO INOX	LOCK NUT	DADO ACCIAIO INOX	ÉCROU INOX
21	REC19-14842	19-14842	TAPA PLÁSTICO	CAP	COPERCHIO IN PLASTICA	COUVERCLE PLASTIQUE
22	REC8M0080805	8M0080805	KIT CONECTOR TRIM	TRIM CONNECTOR KIT	KIT CONNETTORE TRIM	KIT CONNECTEUR TRIM
23	REC87399A2	87399A2	KIT REPARACIÓN TRIM (Alpha one Gen I)	POWER TRIM CYLINDER OVERHAUL KIT (Alpha one Gen I)	KIT RIPARAZIONE CILINDRO (Alpha one Gen I)	KIT REPARACION TRIM (Alpha one Gen I)
24	REC88035	88035	TAPON CILINDRO POWER TRIM Ø 52,8 mm (EXT)	POWER TRIM RAM END CAP Ø 52,8 mm (EXT)	TAPPO CILINDRO POWER TRIM Ø 52,8 mm (EXT)	COUVERCLE VERIN DE TRIM Ø Ext. 52,8 mm
25	REC21380	17-14872A1	KIT EJE SUJECCION para colas con gruesos grandes en ejes de sujeción	POWER TRIM RAM BUSHING KIT for rear anchor pin with large rubber bushings	KIT ASSE POWER TRIM per code con grandi spessori sugli alberi	KIT D'ARBRE DE SERRAGE pour les embase de grandes épaisseurs sur les arbres de serrage

Para saber la referencia del pistón debemos revisar el nº grabado en el brazo Number on cylinder must be checked in order to know piston reference Per sapere il codice del pistone bisogna verificare il nº stampigliato. Pour connaître la référence du piston, il faut vérifier le numéro gravé sur le bras.

ALPHA ONE GEN II (1991+)

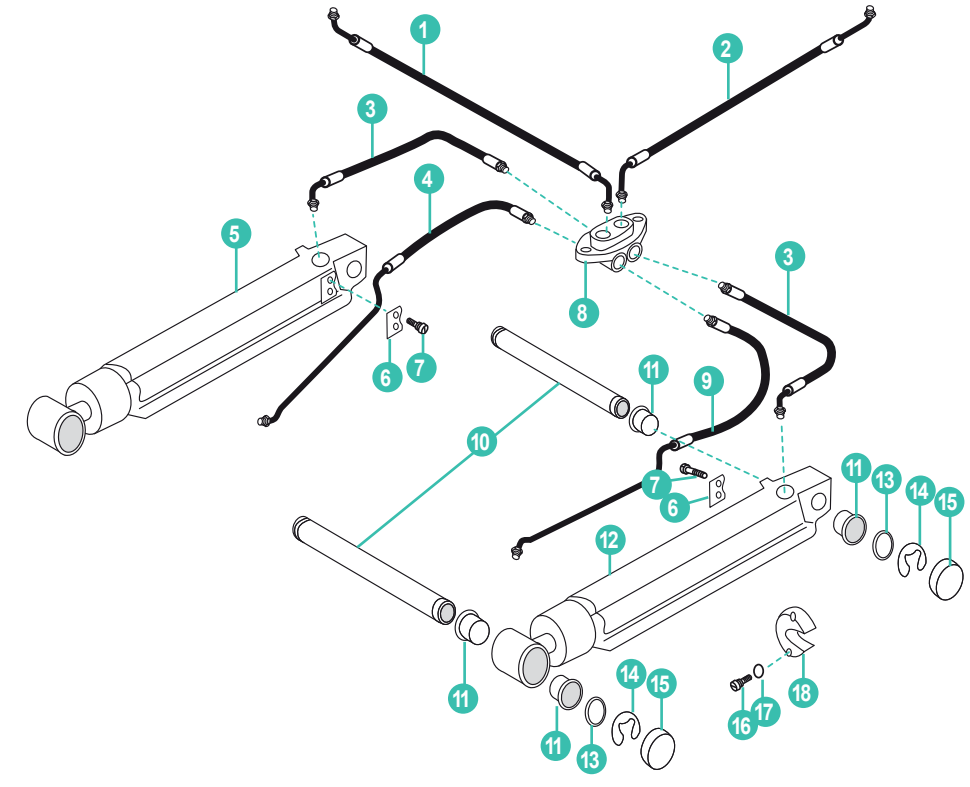

	REF	OEM				
1	REC32-861127	32-861127	LATIGUILLO TRIM (-OW099999) Negro	TRIM HOSE (-OW099999) Black	TUBO TRIM (-OW099999) Nero	FLEXIBLE DE TRIM (-OW099999) Noir
2	REC32-861128	32-861128	LATIGUILLO TRIM (-OW099999) gris	TRIM HOSE (-OW099999) Grey	TUBO TRIM (-OW099999) Grigio	FLEXIBLE DE TRIM (-OW099999) gris
3	REC32-99904	32-999040	LATIGUILLO TRIM	TRIM HOSE	TUBO TRIM	FLEXIBLE DE TRIM
4	REC32-864959	32-864959	LATIGUILLO TRIM	TRIM HOSE	TUBO TRIM	FLEXIBLE DE TRIM
5	REC815935A7	815935A7	CILINDRO TRIM BABOR	TRIM CYLINDER PORT	CILINDRO TRIM SINISTRO	VERIN DE TRIM BABORD
6	REC85060	85060	SUJECCION TUBO	PLATE	SUPPORTO TUBO	PLAQUE SUPPORT
7	REC10-85486	10-85486	TORNILLO (.250 -20x.380)	SCREW (.250 -20x.380)	VITE (.250 -20x.380)	VIS (.250 -20x.380)
8	REC8M0080805	8M0080805	KIT CONECTOR	TRIM CONNECTOR KIT	KIT CONNETTORE TRIM	KIT CONNECTEUR TRIM
9	REC32-864960	32-864960	LATIGUILLO TRIM	TRIM HOSE	TUBO TRIM	FLEXIBLE DE TRIM
10	REC17-815953A01	17-815953A01	EJE	UPPER SHIFT SHAFT	ASSE	ARBRE
11	REC23-8159501	23-8159501	CASQUILLO	POWER TRIM RAM BUSHING	BOCCOLA	BAGUE DE VÉRIN
12	REC815954A7	815954A7	CILINDRO TRIM ESTRIBOR	TRIM CYLINDER STBD	CILINDRO TRIM DESTRO	VERIN DE TRIM TRIBORD
13	REC12-815952	12-815952	ARANDELA	WASHER	RONDELLA	RONDELLE
14	REC53-815949	53-815949	CIERRE METÁLICO	E-RING	CHIUSURA METALLICA	ÉCROU METAL
15	REC19-815951	19-815951	TAPA PLÁSTICO	PLASTIC CAP	COPERCHIO IN PLASTICA	COUVERCLE PLASTIQUE
16	REC10-806290	10-806290	TORNILLO	SCREW	VITE	VIS
17	REC304454	13-69432	ARANDELA	WASHER	RONDELLA	RONDELLE
18	CM806189	806189Q1	ÁNODO ZN	ZN ANODE	ANODO ZN	ANODE ZN
	CM806189A	806189Q1	ÁNODO AL	AL ANODE	ANODO AL	ANODE AL
19	REC8M0080805	8M0080805	KIT CONECTOR TRIM	TRIM CONNECTOR KIT	KIT CONNETTORE TRIM	K KIT CONNECTEUR TRIM
20	REC806191T	806191T	TAPÓN CILINDRO POWER TRIM Ø 48 MM (EXT)	POWER TRIM RAM END CAP Ø 48 MM (EXT)	TAPPO CILINDRO POWER TRIM Ø 48 MM (EXT)	COUVERCLE VERIN DE TRIM Ø Ext. 48 mm
21	REC87399A3	87399A3	KIT REPARACION TRIM	POWER TRIM CYLINDER OVERHAUL KIT	KIT RIPARAZIONE TRIM	KIT REPARACION TRIM
22	REC25-87400A2	25-87400A2	KIT RETENES	POWER TRIM SEAL KIT	KIT TENUTE	KIT JOINTS D'HUILE
23	REC17-8M0065070		KIT EJE SUJECCION	POWER TRIM RAM BUSHING KIT	KIT SUPPORTO	KIT D'ARBRE DE SERRAGE

BRAVO



REF
REC8M0080805



REF
REC806191T

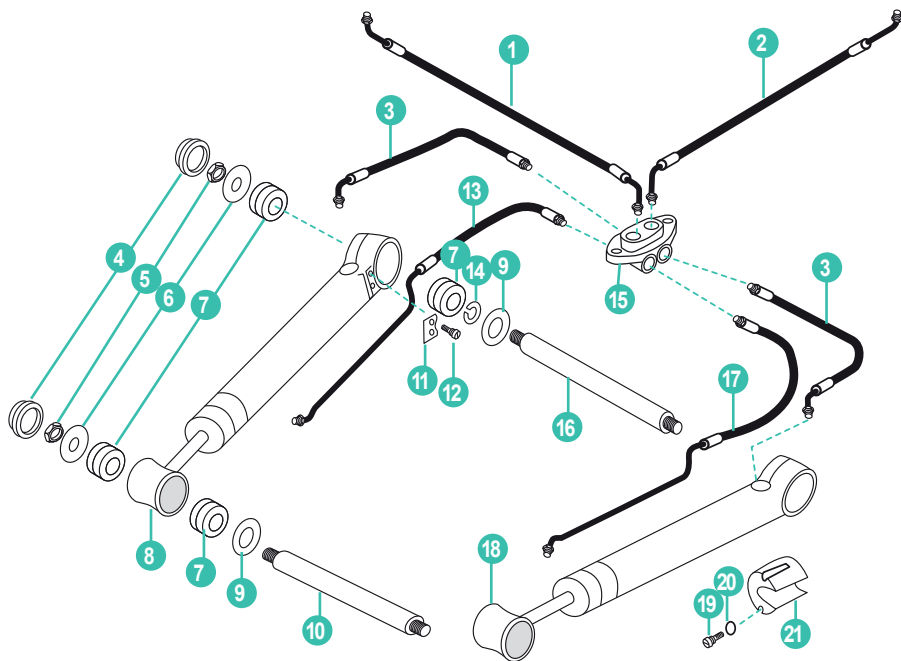

REF
REC87399A2



REF
REC25-87400A2



REF
REC14-44166T1



REF
REC21920



	REF	OEM				
1	REC32-861127	32-861127	LATIGUILLO (-OW099999) Negro	TRIM HOSE (-OW099999) Black	TUBO TRIM (-OW099999) Nero	FLEXIBLE DE TRIM (-OW099999) Noir
2	REC32-861128	32-861128	LATIGUILLO (-OW099999) gris	TRIM HOSE (-OW099999) Grey	TUBO TRIM (-OW099999) Grigio	FLEXIBLE DE TRIM (-OW099999) gris
3	REC32-99904	32-99904Q	LATIGUILLO TRIM	TRIM HOSE	TUBO TRIM	FLEXIBLE DE TRIM
4	REC19-14842	19-14842	TAPA PLÁSTICO	PLASTIC CAP	COPERCHIO IN PLASTICA	COUVERCLE PLASTIQUE
5	REC11-34933	11-859116	TUERCA INOX	LOCK NUT	DADO INOX	ÉCROU INOX
6	REC12-44163	12-44163	ARANDELA	WASHER	RONDELLA	RONDELLE
7	REC23-807073	23-807073	ADAPTADOR GOMA P.T.	P.T. RAM BUSHING	ADATTATORE GOMMA	BAGUE POWER TRIM
8	REC98703A26	98703A26	PISTÓN TRIM BABOR	TRIM CYLINDER PORT	PISTONE TRIM SINISTRO	VERIN DE TRIM BABORD
9	REC12-44164	12-44164	ARANDELA	WASHER	RONDELLA	RONDELLE
10	REC17-44166	17-44166	EJE SUJECCIÓN TRIM	ANCHOR PIN	ASSE TRIM	ARBRE
11	REC85060	85060	SUJECCIÓN TUBO	PLATE	SUPPORTO TUBO	PLAQUE SUPPORT
12	REC10-85486	10-85486	TORNILLO	SCREW	VITE	VIS
13	REC32-864588	32-864588	LATIGUILLO TRIM	TRIM HOSE	TUBO TRIM	FLEXIBLE DE TRIM
14	REC53-805272	53-805272	ARO RETENEDOR	RETAINING RING	ANELLO BLOCCANTE	CLIPS
15	REC8M0080805	8M0080805	KIT CONECTOR	TRIM CONNECTOR KIT	KIT CONNETTORE	KIT CONNECTEUR
16	REC17-44167A1	17-44167A1	EJE SUJECCIÓN TRIM	ANCHOR PIN	ASSE SUPPORTO TUBO	ARBRE FIXATION VERIN DE TRIM
17	REC32-864589	32-864589	LATIGUILLO TRIM	TRIM HOSE	TUBO TRIM	FLEXIBLE DE TRIM
18	REC98704A26	98704A26	PISTÓN TRIM ESTRIBOR	TRIM CYLINDER STBD	PISTONE TRIM DESTRO	VERIN DE TRIM TRIBORD
19	REC10-806290	10-806290	TORNILLO	SCREW	VITE	VIS
20	REC304454	13-69432	ARANDELA	WASHER	RONDELLA	RONDELLE
21	CM806190 CM806190A	806190A1 806190A1	ÁNODO ZN ÁNODO AL	ZN ANODE AL ANODE	ANODO ZN ANODO AL	ANODE ZN ANODE AL
22	REC8M0080805	8M0080805	KIT CONECTOR TRIM	TRIM CONNECTOR KIT	KIT CONNETTORE TRIM	KIT CONNECTEUR
23	REC806191T	806191T	TAPÓN CILINDRO Ø 48 MM (EXT)	RAM END CAP Ø 48 MM (EXT)	TAPPO CILINDRO Ø 48mm (EXT)	NEZ DE VERIN Ø 48mm (ext.)
24	REC87399A2	87399A2	KIT REPARACIÓN TRIM	POWER TRIM CYLINDER OVERHAUL KIT	KIT RIPARAZIONE TRIM	KIT REPARATION VERIN
25	REC25-87400A2	25-87400A2	KIT RETENES	POWER TRIM SEAL KIT	KIT TENUTE	KIT JOINTS DE VÉRIN
26	REC14-44166T1	17-44166T1	KIT EJE SUJECCIÓN TRASERO	POWER TRIM RAM BUSHING KIT (REAR)	KIT ASSE POSTERIORE	KIT ARBRE FIXATION VERIN DE TRIM (arrière)
26	REC21920		KIT EJE SUJECCIÓN DELANTERO	POWER TRIM RAM BUSHING KIT (FRONT)	KIT ASSE ANTERIORE	KIT AXE VERIN DE TRIM (front)

LATIGUILLOS POWER TRIM



POWER TRIM HOSES

TUBI POWER TRIM

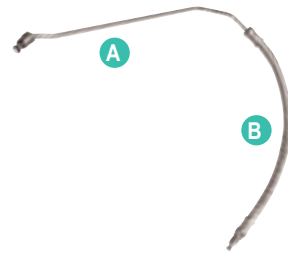

FLEXIBLE DE POWER TRIM

REF	OEM			
REC32-864960	32-99902-1 32-864960	1/8"	11 1/2" + 14"	MCM 120-260 & BRAVO
REC32-864589	32-99902 32-864589			





REF	OEM			
REC32-864959	32-99903-1 32-864959	1/8"	11 1/2" + 14"	MCM 120-260 & BRAVO
REC32-864588	32-99903 32-864588			1/8"





REF	OEM			
REC32-861127	32-861127 32-95858	■	46"	R / MR / ALPHA GEN II BRAVO I, II, III / BRAVO X, XR, XZ (-0W099999)
REC32-861128	32-861128 32-95859	■	51"	sin conectores rápidos without quick connect fittings senza connettori rapidi sans connecteurs rapides



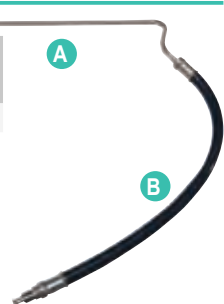

REF	OEM			
REC32-87234	32-87234	1/8"	11 1/2" + 14"	



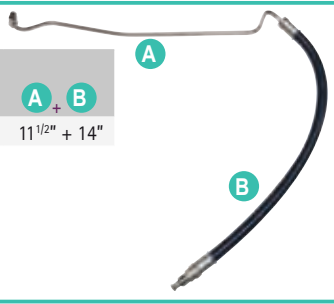

REF	OEM			
REC32-87235	32-87235	1/8"	11 1/2" + 14"	





REF	OEM		
REC32-86036	32-86036 32-86036Q	1/8"	14"



REF	OEM		
REC32-99904	32-99904	1/8"	15"





REF	OEM		
REC32-55816	32-55816	1/8"	21"



REF	OEM		
REC32-59842	32-59842	1/8"	32"



REF	OEM		
REC32-59841	32-59841	1/8"	51"

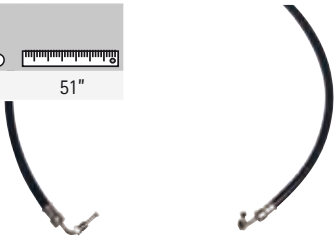

REF	OEM
REC32-58432A2	32-58432A2



EXTRACTOR TAPONES DE TRIM

TRIM PLUGS EXTRACTOR

ESTRATTORE PER TAPPI DI TRIM

KIT EXTRACTEUR

new

REF	
RECTOOLTRIMKIT	RECTOOLTRIM1 + RECTOOLTRIM2 + RECTOOLTRIM 3



REF					
RECTOOLTRIM1	1/2" + RECPIN4	+ RECPIN4.5	38 mm	Mercuriser Alpha One Et Bravo Trim Cylinders	
RECTOOLTRIM2	1/2" + RECPIN4	+ RECPIN4.5	32 mm		
RECTOOLTRIM3	1/2" + RECPIN6		35 mm		

KITS DE RECAMBIO

Los pines de repuesto no tienen garantía.

SPARE KITS

Replacement pins are not guaranteed.

KIT DI RICAMBIO

I perni di ricambio non sono garantiti.

KIT DE RECHANGE

Les pines de remplacement ne sont pas garanties

REF		
RECPIN4	3 PIN x 4 mm	
RECPIN4.5	3 PIN x 4.5 mm	
RECPIN6	3 PIN x 6 mm	



HERRAMIENTAS

TOOLS

ATTREZZI

OUTILS

EXTRACTOR COJINETES Y HELICES

PROP AND BEARING PULLER

ESTRATTORE CUSCINETTI E ELICHE

EXTRACTEUR DE ROUEMENTS ET D'HELICE

REF	
REC90095	

RECMAR®



Para hélices y cojinetes antiguos
For prop and old style bearing carrier.
Per eliche e cuscinetti vecchi.
Pour hélices et roulements anciens



Para cojinetes modernos
For new style bearing carrier.
Per cuscinetti moderni.
Pour roulements récents.



EXTRACTOR COJINETES

BEARING PULLER

ESTRATTORE CUSCINETTI

EXTRACTEUR DE ROUEMENTS

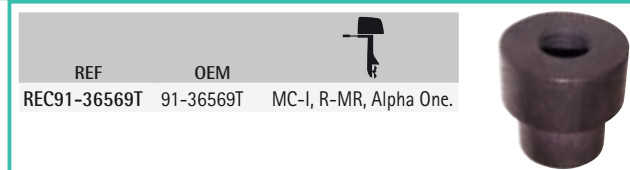
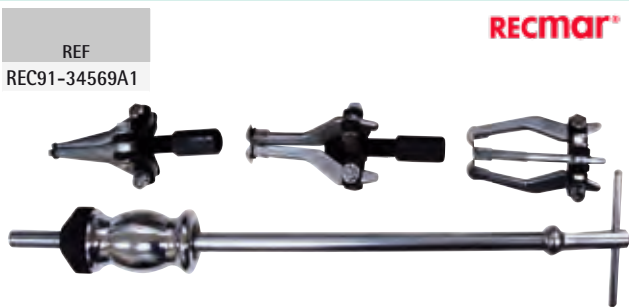

EXTRACTOR PIÑONES Y COJINETES

UNIVERSAL PULLER PLATE

ESTRATTORE PIGNONE E CUSCINETTI

EXTRACTEUR PIGNONS ET ROUEMENTS

REF	PIÑONES BEARINGS PIGNONE PIGNONS
REC91-00001	30-50 mm / 1 ¹ / ₄ " - 2 ¹ / ₄ "
REC91-00002	50-75 mm / 2 ¹ / ₄ " - 3 ¹ / ₂ "
REC91-37241	75-105 mm / 3" - 4 ¹ / ₂ "



RECMAR®

KIT HERRAMIENTAS PARA COLAS

GEAR CASE TOOL KIT

KTI ATTREZZI PIEDI

KIT OUTILS POUR EMBASES

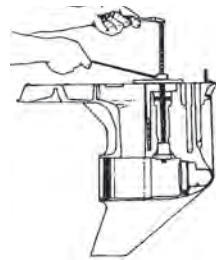

LLAVE TUERCA DIÁBOLO

BEARING CARRIER RETAINER WRENCH

CHIAVE PER CUSCINETTO

CLE POUR ECROU DE DIABOLO



KIT LLAVE HÉLICE

PROP WRENCH KIT

KIT CHIAVE ELICA

CLE POUR ECROU D'HELICE

REF			FLOTANTE FLOATING GALLEGGIANTE FLOTTANTE	
REC91-859046Q4	1 1/16"	75 - 300 HP	REF	
			REC91-859046Q3	
1 1/16"			15/16"	
75 - 300 HP			30, 40, 50 & 60 HP	

LLAVE TUERCA EJE VERTICAL

PINION NUT ADAPTOR KIT

CHIAVE DADO ASSE VERTICALE

CLE POUR ARBRE VERTICAL

Incluye un adaptador eje. Sostiene la tuerca del piñón cuando se está sacando el piñón y el eje en las colas. Holds pinion nut when removing pinion gear and drive shaft on drive units. Comes with drive shaft adaptor. Include un adattatore albero. Tenendo il dado del pignone quando si rimuove la ruota dentata e l'albero nel piede. Inclus un adaptateur d'arbre. Maintient l'écrou du pignon lors de la dépose du pignon et de l'axe sur les embases.



Para montaje y desmontaje del retenedor y cojinete superior en colas. Removes and installs threaded bearing retainer on stern drives. Per il montaggio e lo smontaggio del fermo di ritengo e del cuscinetto superiore dei piedi. Pour le montage et le démontage de la retenue et du palier supérieur dans les embases.



EXTRACTOR POLEA BOMBA DE DIRECCIÓN

PULLEY REMOVER, DRIVE PUMP

RIMOZIONE PULEGGIA, POMPA STERZO

EXTRACTEUR DE POULIE POMPE DE DIRECTION

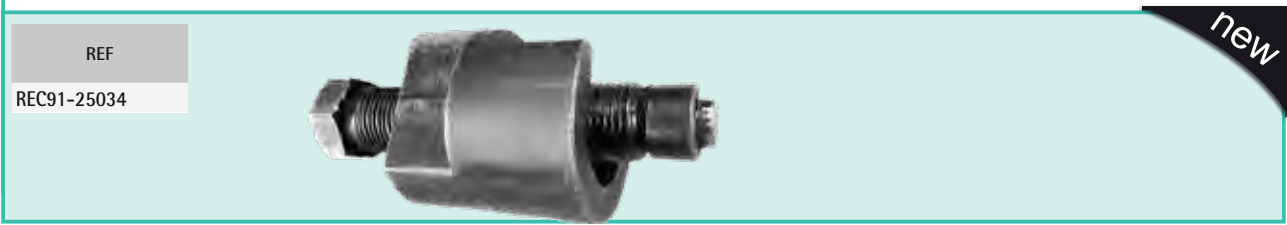

LLAVE ESTRIDADO EJE **PROP SHAFT ADAPTOR** **CHIAVE ASSE STRIATO** **CLE POUR ARBRE D'HELICE**

Da una superficie de llave para girar el eje de la hélice en las colas. Provides a wrench surface to turn the propeller. Fornisce una superficie di chiave per ruotare l'asse del propulsore nel piede. Fournit une surface de clé pour faire tourner l'arbre d'hélice sur les embases.

REF	OEM	
REC91-56775T	91-56775T	MC-I, R-MR, TRS, Alpha One Et Gene II.
REC91-61077T	91-61077T	



REC91-61077T



REC91-56775T

EXPANSOR DE FUELLES **BELLOWS EXPANDER TOOL** **ATTREZZO PER CUFFIE** **OUTIL DE MONTAGE SOUFFLETS**

REF	OEM	
REC91-45497A1	91-45497A1	MC-1/R/MR Alpha One/Alpha One Gen II Bravo, Et Blackhawk



ÚTIL INSTALACIÓN ANILLO DE FUELLE **BELLOWS RING INSTALLATION TOOL** **STRUMENTO PER L'INSTAL DELL'ANELLO DEL SOFFIETTO** **OUTIL D'INSTALLATION DE L'ANNE DE SOUFFLET**

REF	OEM	
REC91-818162	91-818162	Alpha Gen II Et Bravo



LLAVE GALGADO PIÑONES **PINION GEAR SHIMMING TOOL** **CHIAVE PER PIGNONI** **CLE POUR PIGNONS**

Mide la altura del piñón en las colas MC-I, R-MR, Alpha One y Gene II Measures pinion height of MC-I; R-MR; Alpha One; and Alpha One, Gen Two drive units. Misurare l'altezza del pignone nel piede MC-I, R-MR, Alpha One e Gen II. Mesure la hauteur du pignon sur les queues MC-I, R-MR, Alpha One et Gene II

REF	OEM
REC91-56048001	91-56048001
REC91-60523	91-60523
REC91-60526T	91-60526T

REC91-56048001



REC91-60526T



REC91-60523

CENTRADOR MOTOR **ENGINE ALIGNMENT TOOL** **CENTRATORE MOTORE** **OUTIL D'ALIGNEMENT**

Centra el motor y la cola durante la instalación. Aligns engine and drive unit during installation. Centra il motore con il piede durante l'installazione Centre le moteur et la queue pendant l'installation

REF	OEM
REC91-805475A1	91-805475A1



LLAVE TORNILLO LATERAL TRANSOM **HINGE PIN TOOL** **CHIAVE VITE LATERALE TRANSOM** **OUTIL DE DÉMONTAGE DE PIVOT POUR EMBASE**

Instala y desinstala los tornillos laterales de las colas. Removes and installs hinge pins from drive units. Per tutti i piedi Mercuriser. Installe et désinstalle les vis à queue latérales.

REF	OEM
REC91-78310	91-78310



LLAVES PARA ELEMENTOS DEL CAMBIO

TOOLS FOR ELEMENTS TO DRIVESHAFT

CHIAVI PER GLI ELEMENTI DEL CAMBIO

ADAPTATEUR ARBRE DE TRANSMISSION

Llave montaje y desmontaje casquillo sujeción tubo de agua.

Drive shaft adapter.

Chiave per smontare e montare la ghiera del tubo acqua.

Clé pour le montage et le démontage de la douille de fixation de la conduite d'eau.

REF	OEM	
REC91-43579	91-43579	Bravo I, II & III



Llave montaje retenes y casquillos eje cambio.

Driveshaft shimming tool.

Chiave per smontare paraolio e ghiera asse cambio.

Clé de montage des joints et des bagues de l'arbre de transmission.

REF	OEM	
RM91-17275A1	91-17275A1	Bravo I, II & III



Llave tuerca varilla cambio. Para montaje y desmontaje de las tuercas de la varilla cambio en las colas.

Shift shaft bushing tool. Removes and installs the shift shaft bushing in the gear case of drive units.

Chiave per il dado dell'asta del cambio. Per montare e smontare i dadi dell'asta del cambio sulle code.

Clé pour l'écrou de la tige de changement de vitesse. Pour le montage et le démontage des écrous de la tige de changement de vitesse sur les queues.

REF	OEM	
REC91-31107T	91-31107T	MC-I, R-MR, Alpha One.



Llave cable cambio. Para montaje y desmontaje de los cables de cambio en las colas.

Shift cable tool. Installs and removes drive shaft bearing retainer on drive units.

Chiave cavo cambio. Per installare e smontare i cavi cambio nei piedi.

Clé pour câble de changement de vitesse. Pour monter et démonter les câbles de changement de vitesse sur les queues.

REF	OEM	
REC91-12037	91-12037	MC-I, R-MR, Alpha One, Gen II.



Llave montaje casquillos eje cambio.

Bushing removal tool.

Chiave per montare ghiera asse cambio.

Clé de montage de la douille de l'arbre de transmission.

REF	OEM	
RM91-17273	91-17273	Bravo I, II & III



Llave extractora eje cambio.

Shift handle tool. F

Chiave estrattore asse cambio.

Clé d'extraction pour l'arbre de transmission.

REF	OEM	
RM91-17302	91-17302	Bravo I, II & III



EXTRACTOR

PULLEY ROD

ESTRATTORE

EXTRACTEUR DE POULIE

Para utilizar con las herramientas REC91-43579 y REC91-36569T para instalar y desmontar el cojinete

Used with REC91-43579 & REC91-36569T tools to install & remove pinion bearing.

Da utilizzare con gli strumenti REC91-43579 e REC91-36569T per installare e smontare il cuscinetto.

A utiliser avec les outils REC91-43579 et REC91-36569T pour installer et retirer le roulement

REF
REC91-31229



LLAVE TUERCA CARDAN

BEARING RETAINER WRENCH

CHIAVE CARDANO

CLÉ POUR ÉCROU D'ARBRE

REF	OEM	
REC91-17256	91-17256	MC-I, R-MR, Blackhawk, Alpha y Bravo.



REF	OEM	
REC90490	91-17257T 91-8053741	Bravo II Et Bravo III



VACUÓMETRO DOBLE FUNCIÓN

PRESSURE / VACUUM TESTER

VACUOMETRO DOPPIA FUNZIONE

VACUOMETRE DOUBLE FONCTION

Presión y vacío. Ideal para comprobar las unidades de transmisión, sensores, vst, etc.

Combination unit that does pressure and vacuum testing in one units. Recommended to test drives.

Pressione e sottovuoto. Ideale per il controllo dei piedi.

Unité combinée qui effectue des tests de pression et de vide. Recommandé pour tester les embases.

REF
REC55134

RECMAR®



PISTOLA DE ACEITE

BOTTLE GREASE PUMP

PISTOLA OLIO

PISTOLET POUR HUILE D'EMBASE

Pistola para acoplar en los envases de botella de 1 L LUB11552 y LUB11564. Se suministra con kit de adaptación con válvula anti-retorno.

Lower unit quart pump. Complete with metal threaded filler fitting.

Pistola da accoppiare a bottiglie da 1 L LUB11552 e LUB11564. Si vende con kit di accoppiamento con valvola anti-ritorno.

Pistolet pour les bidons d'huile de 1 L LUB11552 et LUB11564. Vendu avec kit de couplage avec clapet anti-retour.

REF
REC55005

RECMAR®



ADAPTADOR PARA EMBASES RECLUBE

ADAPTOR FOR RECLUBE CONTAINERS

ADATTATORE PER CONTENITORI RECLUBE

ADAPTATEUR POUR CONTENEURS RECLUBE

Para la pistola de aceite REC55005.

For REC55005 bottle grease pump.

Per pistola olio REC55005.

Pour le pistolet REC55005.

REF
REC55006



SISTEMA DE PROPULSIÓN PROPULSION SYSTEM

SISTEMA DI PROPULSIONE SYSTEME DE PROPULSION

HÉLICES ALUMINIO E INOXIDABLE DE 3 Y 4 PALAS	3 & 4 BLADE ALUMINIUM & SS PROPELLERS	ELICHE ALLUMINIO E INOX DA 3 E 4 PALE	HELICE ALUMINIUM ET INOX 3 ET 4 PALES
CÓDIGO DE REFERENCIAS	PART NO. CODING SYSTEM	SISTEMA DI CODICE	CODAGE DES REFERENCES
<p>D (∅) P (Pitch) M</p> <p>i.e. 13 1/4 → 133 i.e. 17° → 17</p> <p>Pin Drive Propeller 1, 2, 5 Different Propeller Hub Fitting Spec.</p>			
<p>1. Mercury, Mariner</p> <p>2. Johnson, Evinrude</p> <p>3. Yamaha</p> <p>4. Suzuki</p> <p>5. Tohatsu</p> <p>6.</p> <p>7.</p> <p>8. Volvo Penta</p> <p>9. Rubex System</p>	<p>0.5, 6, 8 and 9.8 HP Group</p> <p>1. A Group</p> <p>2. B Group</p> <p>3. C Group</p> <p>4. D Group</p> <p>5. E Group</p> <p>6. F Group</p> <p>7. VP (Std. Hub)</p> <p>8. VP (Long Hub)</p>	<p>1. AL</p> <p>2. Saturn (INOX Stainless Steel)</p> <p>3. New Saturn (INOX Stainless Steel)</p> <p>4. Titan (INOX Stainless Steel)</p> <p>5. HR Titan (INOX Stainless Steel)</p> <p>6. Scorpion (INOX Stainless Steel)</p> <p>7. Lexor (INOX Stainless Steel)</p>	<p>1. 3R Rubber Hub</p> <p>2. 3L Rubber Hub</p> <p>3. 4R Rubber Hub</p> <p>4. 4L Rubber Hub</p>



AMITA 3



Hélice de aluminio con núcleo de goma de gran resistencia.

Aluminum propeller with heavy duty rubber hub.

Eliche di alluminio con mozzi in gomma ad alta resistenza.

Hélice en aluminium avec moyeu en caoutchouc



AMITA 4



Hélices de aluminio con núcleo de goma de gran resistencia. Van muy suaves a poca velocidad y hace el barco muy manejable con la mar picada.

Aluminum propeller with heavy duty rubber hub. Smoother low speed makes the offshore boating activity much easier.

Eliche di alluminio con mozzo in gomma ad alta resistenza. Molto morbido a bassa velocità e rende la barca molto maneggevole con mare cattivo.

Hélice en aluminium avec moyeu en caoutchouc. Permet d'aller doucement à basse vitesse et rende le bateau très maniable lorsque la mer est agitée



LEXOR



Hélices de acero inoxidable. Gran diámetro del área de las palas para barcos pesados. Gran rendimiento en alta velocidad sin sacrificar las velocidades medias. Excelente ahorro de combustible.

Stainless steel propeller. Large diameter and blade area for big boat loads. Great high speed performance without sacrificing mid-range speeds. Excellent fuel economy.

Eliche di acciaio inox. Grande diametro delle pale per imbarcazioni pesanti. Grandi prestazioni ad alta velocità senza sacrificare velocità medie. Eccellente risparmio di carburante.

Hélice inox, grand diamètre pour bateaux lourds. Excellentes performances à grande vitesse sans sacrifier les vitesses moyennes. Excellente économie de carburant.



NEW SATURN



Hélices de acero inoxidable. Ofrece buena aceleración y rendimiento. Tamaño más pequeño que ofrece un diámetro extragrande.

Stainless steel propeller. Offers good acceleration & all-round performance. Smaller pitch sizes offered in extra large diameter with increased blade area.

Eliche di acciaio inox. Buona accelerazione. Piccole dimensioni che offre un più grande diametro.

Hélice inox, offrant de bonnes accélérations et performances. Taille de pas réduite pour les modèles de grands diamètres avec une surface de pale plus importante.



HR TITAN 3 PROP



Hélice de acero inoxidable. Alto rendimiento para cascos de alta velocidad. La inclinación de la hoja proporciona un excelente elevación de proa y aceleración. El diseño de copa grande aumenta la mordida y reduce el deslizamiento.

Stainless steel propeller. Performance prop for high speed planning hulls. High rake blade design provides excellent bow lift and acceleration. Heavy cup design increases bite and reduces slip.

Eliche in acciaio inox. Alte prestazioni per scafi ad alta velocità. Il passo della pala fornisce un'eccellente spinta e accelerazione. Il disegno aumenta le prestazioni.

Hélice en acier inoxydable. Hélice de performance pour les coques de planification à grande vitesse. La conception de la lame à haut râteau offre une excellente portance et accélération de l'arc. La conception lourde de la tasse augmente la morsure et réduit le glissement.



GUÍA DE HÉLICES CON NÚCLEO INTEGRADO

PROPELLERS APPLICATION WITH RUBBER HUB

GUIDA ELICHE CON MOZZO

GUIDE DES HELICES ET MOYEUX

	R.O. OEM	B	D	P	R	TIPO	AL		INOX STAINLESS STEEL		
							AMITA 3	AMITA 4	NEW SATURN	HR TITAN 3	LEXOR
	48-78114A45	3	16	13	R	BLACK MAX	SOL1511-160-13		SOL1531-156-13		
	48-78116A4	3	15 1/2	15	R	BLACK MAX		SOL1513-148-15	SOL1531-145-15		
	48-832828A45	3	15	17	R	BLACK MAX	SOL1511-150-15	SOL1513-145-17	SOL1531-143-17		
	48-832830A45	3	14 1/2	19	R	BLACK MAX	SOL1511-148-17	SOL1513-143-19	SOL1531-140-19		
	48-832832A45	3	14 1/2	21	R	BLACK MAX	SOL1511-145-19	SOL1513-140-21	SOL1531-140-21		
	48-832834A45	3	14	23	R	BLACK MAX	SOL1511-143-21	SOL1513-140-23	SOL1531-140-23		
	48-78126A45	3	13 3/8	25	R	BLACK MAX	SOL1511-142-23		SOL1531-140-25		
	48-831850A45	4	15	16	R	ALPHA 4		SOL1513-145-17			
	48-834851A45	4	15	16	L	ALPHA 4		SOL1514-145-17			
	48-834852A45	4	14 1/2	18	R	ALPHA 4		SOL1513-143-19			
	48-834853A45	4	14 1/2	18	L	ALPHA 4		SOL1514-143-19			
	48-834854A45	4	14	20	R	ALPHA 4		SOL1513-140-21			
	48-834855A45	4	14	20	L	ALPHA 4		SOL1514-140-21			
	48-16312A46	3	14 1/2	15	R	VENGEANCE			SOL1531-145-15		
	48-16314A46	3	14 1/2	17	R	VENGEANCE			SOL1531-143-17	SOL1551-148-16	
	48-16315A46	3	14 1/2	17	L	VENGEANCE			SOL1532-143-17	SOL1552-148-16	
	48-16316A46	3	14	19	R	VENGEANCE			SOL1531-140-19	SOL1551-148-18	
	48-16317A46	3	14	19	L	VENGEANCE			SOL1532-140-19	SOL1552-148-18	
	48-16318A46	3	13 3/4	21	R	VENGEANCE			SOL1531-140-21	SOL1551-148-20	
	48-16319A46	3	13 3/4	21	L	VENGEANCE			SOL1532-140-21	SOL1552-148-20	
	48-16320A46	3	13 1/2	23	R	VENGEANCE			SOL1531-140-23	SOL1551-143-22	
	48-16321A46	3	13 1/2	23	L	VENGEANCE			SOL1532-140-23	SOL1552-143-22	
	48-16322A46	3	13 3/8	25	R	VENGEANCE			SOL1531-140-25	SOL1551-140-24	
	48-16544A46	3	14	19	R	LASER II				SOL1551-148-19	
	48-16543A46	3	14	19	L	LASER II				SOL1552-148-19	
	48-16546A46	3	13 7/8	21	R	LASER II				SOL1551-145-21	
	48-16545A46	3	13 7/8	21	L	LASER II				SOL1552-145-21	
	48-16548A46	3	13 3/4	23	R	LASER II				SOL1551-143-22	
	48-16547A46	3	13 3/4	23	L	LASER II				SOL1552-143-22	
	48-16550A46	3	13 3/4	25	R	LASER II				SOL1551-140-24	
	48-16549A46	3	13 3/4	25	L	LASER II				SOL1552-140-24	
	48-826072A46	3	16	13	R	MIRAGE PLUS	SOL1511-160-13				
	48-19838A46	3	15 3/4	15	R	MIRAGE PLUS	SOL1511-158-15				
	48-19841A46	3	15 3/4	15	L	MIRAGE PLUS	SOL1512-158-15				
	48-18278A46	3	15 1/2	17	R	MIRAGE PLUS	SOL1511-155-17				SOL1571-155-17
	48-90159A46	3	15 1/2	17	L	MIRAGE PLUS	SOL1512-155-17				SOL1572-155-17
	48-13700A46	3	15 1/4	19	R	MIRAGE PLUS	SOL1511-153-19				SOL1571-153-19
	48-13701A46	3	15 1/4	19	L	MIRAGE PLUS	SOL1512-153-19				SOL1572-153-19
	48-13702A46	3	13 3/4	21	R	MIRAGE PLUS	SOL1511-153-21				SOL1571-150-21
	48-13703A46	3	14 3/4	21	L	MIRAGE PLUS	SOL1512-153-21				SOL1572-150-21
	48-13704A46	3	14 5/8	23	R	MIRAGE PLUS	SOL1511-153-23				SOL1571-148-23
	48-13705A46	3	14 5/8	23	L	MIRAGE PLUS					SOL1572-148-23
	48-13706A46	3	14 1/2	25	R	MIRAGE PLUS					SOL1571-145-25
	48-13707A46	3	14 1/2	25	L	MIRAGE PLUS					SOL1572-145-25
	48-18610A40	3	19 1/4	15	R	ALUM	SOL1611-193-15			SOL1641-193-15	
	48-18611A40	3	19 1/4	15	L	ALUM	SOL1612-193-15			SOL1642-193-15	
	48-18612A40	3	18 3/4	17	R	ALUM	SOL1611-188-17			SOL1641-188-17	
	48-18613A40	3	18 3/4	17	L	ALUM	SOL1612-188-17			SOL1642-188-17	
	48-18614A40	3	18 1/4	19	R	ALUM	SOL1611-183-19			SOL1641-183-19	
	48-18615A40	3	18 1/4	19	L	ALUM	SOL1612-183-19			SOL1642-183-19	
	48-18616A40	3	17 3/4	21	R	ALUM	SOL1611-178-21			SOL1641-178-21	
	48-18617A40	3	17 3/4	21	L	ALUM	SOL1612-178-21			SOL1642-178-21	
	48-18618A40	3	17 1/2	23	R	ALUM				SOL1641-175-23	
	48-18619A40	3	17 1/2	23	L	ALUM				SOL1642-175-23	
	48-18620A40	3	17 1/4	25	R	ALUM				SOL1641-175-23	
	48-18621A40	3	17 1/4	25	L	ALUM				SOL1642-173-25	
	48-18610A6	3	19 1/4	15	R	SS	SOL1611-193-15			SOL1641-193-15	
	48-18611A6	3	19 1/4	15	L	SS	SOL1612-193-15			SOL1642-193-15	
	48-18612A6	3	18 3/4	17	R	SS	SOL1611-188-17			SOL1641-188-17	
	48-18613A6	3	18 3/4	17	L	SS	SOL1612-188-17			SOL1642-188-17	
	48-18614A6	3	18 1/4	19	R	SS	SOL1611-183-19			SOL1641-183-19	
	48-18615A6	3	18 1/4	19	L	SS	SOL1612-183-19			SOL1642-183-19	
	48-18616A6	3	17 3/4	21	R	SS	SOL1611-178-21			SOL1641-178-21	
	48-18617A6	3	17 3/4	21	L	SS	SOL1612-178-21			SOL1642-178-21	
	48-18618A6	3	17 1/2	23	R	SS				SOL1641-175-23	
	48-18619A6	3	17 1/2	23	L	SS				SOL1642-175-23	
	48-18620A6	3	17 1/4	25	R	SS				SOL1641-173-25	
	48-18621A6	3	17 1/4	25	L	SS				SOL1642-173-25	

BRAVO III

HELICES DE ACERO INOXIDABLE
Hélices delanteras de 4 palas y hélices traseras de 3 palas. 19 estrias y escape a través de la hélice.

STAINLESS STEEL PROPELLERS
Front propellers with 4 blades & rear propellers with 3 blades. 19 Tooth Splines and Thru hub exhaust.

ELICHE IN ACCIAIO INOX
Eliche anteriori da 4 pale e eliche posteriori da 3 pale. 19 denti e scarico all'elica.

HÉLICES EN ACIER INOXYDABLE
Hélices avant à 4 pales et hélices arrière à 3 pales. 19 cannelures et l'échappement par l'hélice.

DELANTERA FRONT ANTERIORE DAVANT	IZQUIERDA LEFT SINISTRA GAUCHE	TRASERA REAR POSTERIORE ARRIÈRE	DERECHA RIGHT DESTRA DROIT	B	D	P
SOL1654-160-20				4	16"	20
		SOL1651-144-20		3	14 3/8"	20
SOL1654-160-21				4	16"	21
		SOL1651-144-21		3	14 3/8"	21
SOL1654-158-22				4	15 3/4"	22
		SOL1651-143-22		3	14 1/4"	22
SOL1654-158-23				4	15 3/4"	23
		SOL1651-143-23		3	14 1/4"	23
SOL1654-155-24				4	15 1/2"	24
		SOL1651-140-24		3	14"	24
SOL1654-155-25				4	15 1/2"	25
		SOL1651-140-25		3	14"	25
SOL1654-155-26				4	15 1/2"	26
		SOL1651-140-26		3	14"	26
SOL1654-155-27				4	15"	27
		SOL1651-140-27		3	13 3/4"	27
SOL1654-150-28				4	15"	28
		SOL1651-138-28		3	13 3/4"	28

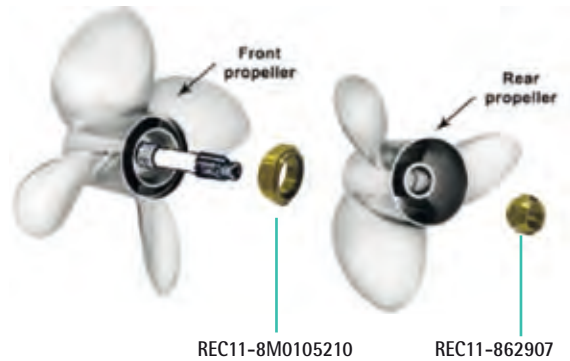

HÉLICES 3 PALAS ALPHA ONE Y BRAVO ONE

Altas prestaciones. Núcleo de goma intercambiable con sistemas flo-torq & Vortex System. Disponible en acero inox y aluminio

3 BLADE PROPELLERS ALPHA ONE & BRAVO ONE

High performance / Rubber Hub interchangeable with flo-torq & Vortex System. Available in stainless Steel & Aluminium Propeller

ELICHE DA 3 PALE ALPHA ONE / BRAVO ONE

Alte prestazioni. Mozzo in gomma intercambiabile con sistema flo-torq & Vortex System. Disponibile in acciaio inossidabile e alluminio.

HÉLICES À 3 PALES ALPHA ONE, BRAVO ONE

Haute performance. Noyau en caoutchouc interchangeable avec le système flo-torq et Vortex. Disponible en acier inoxydable et en aluminium.

REF	OEM	
SOLRBX-102		ALPHA ONE BRAVO ONE



RUBEX



-400 HP

-400 HP

AL	A	B	D	P	R
SOL9511-153-13		3	15,3	13	R
SOL9511-150-15		3	15	15	R
SOL9512-150-15		3	15	15	L
SOL9511-148-17		3	14,8	17	R
SOL9512-148-17		3	14,8	17	L
SOL9511-145-19		3	14,5	19	R
SOL9512-145-19	15	3	14,5	19	L
SOL9511-143-21		3	14,3	21	R
SOL9512-143-21		3	14,3	21	L
SOL9513-148-15		4	14,75	15	R
SOL9513-145-17		4	14,5	17	R
SOL9513-143-19		4	14,25	19	R
SOL9513-140-21		4	14	21	R

INOX SS	A	B	D	P	R
SOL9571-158-15		3	15 3/4	15	R
SOL9572-158-15		3	15 3/4	15	L
SOL9571-155-17		3	15 1/2	17	R
SOL9572-155-17		3	15 1/2	17	L
SOL9571-153-19		3	15 1/4	19	R
SOL9572-153-19		3	15 1/4	19	L
SOL9571-150-21	15	3	15	21	R
SOL9572-150-21		3	15	21	L
SOL9571-148-23		3	14 3/4	23	R
SOL9572-148-23		3	14 3/4	23	L
SOL9571-145-25		3	14 1/2	25	R
SOL9572-145-25		3	14 1/2	25	L
SOL9531-145-15		3	14 1/2	15	R
SOL9532-145-15		3	14 1/2	15	L
SOL9531-143-17		3	14 1/4	17	R
SOL9532-143-17		3	14 1/4	17	L
SOL9531-140-19	15	3	14	19	R
SOL9532-140-19		3	14	19	L
SOL9531-140-21		3	14	21	R
SOL9532-140-21		3	14	21	L
SOL9531-140-23		3	14	23	R
SOL9532-140-23		3	14	23	L



TABLA DE APLICACIÓN DE HELICES SOLAS		PROPELLERS SOLAS APPLICATION GUIDE				GUIDA APPLICAZIONE ELICHE SOLAS				TABLEAU D'APPLICATION DE L'HELICE SOLAS				
		AMITA3	AMITA4	BRAVO TWO	SATURN	NEW SATURN	TITAN	HR TITAN3	HR TITAN4	SCORPION	LEXOR	SOLAS SKI	SOLAS PLASTIC	HIGH THRUST
FUERABORDA OUTBOARD FUORIBORDO HORSBORD	INFLATABLE	✓	✓		✓	✓	✓						✓	
	ALUMINIUM	✓	✓		✓	✓	✓							
	SKI BOAT	✓	✓				✓							
	BASSBOAT	✓								✓				
	FLATS BOAT	✓							✓					
	BAY BOAT										✓			
	WALLEYE BOAT	✓									✓			
	OFFSHORE SINGLE	✓	✓				✓	✓	✓		✓			
	OFFSHORE DUAL	✓	✓				✓	✓	✓		✓			
	SPORT BOAT SINGLE										✓			
	SPORT BOAT DUAL										✓			
	HEAVY WORK BOAT	✓	✓			✓	✓		✓					
	COMMERCIAL	✓			✓									
	SAIL DRIVE													✓
	PLEASURE RUNABOUT	✓	✓		✓	✓	✓		✓					
	DECK BOAT	✓	✓						✓					
PONTOON	✓	✓		✓	✓	✓								
DENTRO-FUERABORDA STERNDRIVE ENTROFUORIBORDO HORSBORD	SKI BOAT													
	SPORT BOAT SINGLE								✓		✓			
	SPORT BOAT DUAL								✓		✓			
	FAMILY CRUISER	✓	✓				✓	✓	✓		✓			
	CRUISER BOAT			✓										
	DECK BOAT								✓					
	PONTOON								✓					
	HOUSEBOAT	✓	✓		✓	✓	✓		✓		✓			
INBOARD SKI BOAT											✓			
CARACTERÍSTICAS FEATURES CARATTERISTICHE CARACTERISTIQUES		AL	AL	AL INOX SS	INOX SS	INOX SS	INOX SS	INOX SS	INOX SS	INOX SS	INOX SS	INOX SS	PLAST.	AL
	B	3	4	3	3	3	3	3	4	3	3	3.4	3	4
	R	L	L	L	L	L	L	L	L	L	L	R	R	R
	NUCLEO DE GOMA RUBBER HUB MOZZO GOMMA NOYAU CAOUTCHOUC	✓	✓	✓	✓	✓	✓	✓	✓	✓	✓			✓

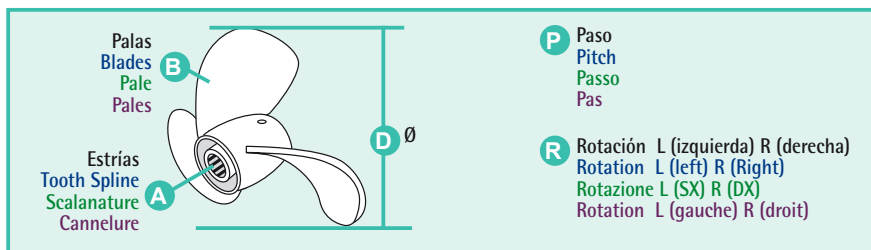

REF --> OEM

REF	OEM	
A		
AM603905	88-832969T05	159
AM603910	88-832969T10	159
AM603915	88-832969T15	159
AM603920	88-832969T20	159
AM603930	88-832969T30	159
AMITA3		316
AMITA4		316

REF	OEM	
B		
BA1-47638	47638A1	218-250
BAMC-1-58759	58759A1	243
BAMC-1-58759	58759A10	243
BAMC-1-58759	58759A13	243
BAMC-1-58759	58759A14	225-243
BAMC-1-58759		248-250-252
BAMC-1-63122	63122A10	218-242
BAMC-1-63122	63122A13	212-242
BAMC-1-63122	63122A14	218-242
BAMC-1-63122		250-252
BAMC-1-95862	95862A5	221-242-250-253
BAMC-20-14478	14478T	249
BAMC-20-14478	14478T01	227-230-237-239-249
BAMC-20-55538	39920	245
BAMC-20-55538	55538A2	218-245
BAMC-20-55538		251
BAMC-20-864908A1	864908A1	229-233-249
BAMC1-47735	47735	244
BAMC1-47735	47735A1	244
BAMC1-47735	47735A17	240-244
BAMC1-47735		248-250-253
BAMC1-47736	47736	244
BAMC1-47736	47736A17	240-244
BAMC1-47736		248-250-253
BAMC1-47737	47737A1	240-244
BAMC1-47737	47737A10	244
BAMC1-47737		248-250
BAMC1-47738	47738A1	240-244
BAMC1-47738	47738A10	244
BAMC1-47738		248-250
BAMC20-61811A4	61811A3	248
BAMC20-61811A4	61811A4	248
BAMC20-61811A4		240
BAMC20-61851A3	61851A3	225-235-241-248
BAMC20-72963	48101A1	246
BAMC20-72963	72963A1	246
BAMC20-72963	72963A9	240-246
BAMC20-72963	76788A1	246
BAMC20-72963		251
BAMC20-76668	47877A4	245
BAMC20-76668	72964A1	245
BAMC20-76668	76668A1	245
BAMC20-76668	76668A3	240-245
BAMC20-76668		251
BAMC29-47587	47587	177
BAMC29-47587	47587A2	177
BAMC29-47587	861493A07	177
BAMC29-47587	861493A3	177
BAMC29-47587		180
BAMC29-59498	59498	180
BAMC29-59498	59498A1	180
BAMC29-60372	60372A1	180
BAMC29-60372	60372A2	180
BAMC29-60372	861493A07	180
BAMC29-62898	62898	180
BAMC29-62898	62898A1	180
BAMC29-63588	889333	178
BAMC29-63588	63588A1	178
BAMC29-63588		180
BAMC29-78985	78985A1	178-180
BAMC47-27-39923	39916	250
BAMC47-27-39923	27-39923	218-250

BRA125-1/2x1/2		123
BRA125-1/2x3/4		123
BRA125-1/2x3/8		123
BRA125-1/4x1/2		123
BRA125-1x3/4		123
BRA125-3/16x1/4		123
BRA125-3/4x3/4		123
BRA125-3/8x1/2		123
BRA125-3/8x3/8		123
BRA125-5/16x3/8		123
BRA125-5/8x3/4		123
BRA125-5/8x3/8		123
BS2138	88-8M2011907	158
BS2142	88-11178A01	158
BS2143	88-93582	158
BS5138		159
BS5139		159
BS5140	88-79023A94	159
BS5141		159
BS5142		159
BS5143		159
BS5175	88-8M0129533	159
BS5177	88-8M0129534	159
BS5181	88-8M0129535	159
BS5182	88-8M0129560	159
BS5183	88-8M0130941	159

REF	OEM	
C		
BS5185	88-8M0129528	159
BS5187	88-8M0129530	159
BS5189	88-8M0129531	159
BS5191		159
BS5291		159
BS5292	862646	159
BS5293		159
BS5294	862647	159
BS5295		159
BS5296	88-212619	159
BS5297		159
BS5298		159
BS5299		159

CARP74021		127
CEF500106GT	47-801332602	188
CEF500109	47-59362Q01	188
CEF500114T	47-879194186	188
CEF500120T	47-879312025	188
CEF500155	47-896332063	188
CEF500159G	47-862232A2	188
CEF500159G	47-8M0104229	188
CEF500161	47-809866T	188
CEF500161	47-831311350	188
CEF500167	3349198	188
CEF500167	3916720	188
CEF500167	47-853126	188
CEF500167	8M0056956	188
CEF500177GT	47-816814T	188
CEF500183G	3972366	188
CEF500301	47-43026Q02	188
CEF500313G	47-8998474	188
CEF500507K	32-44348	253
CEF500507K	32-44348001	253
CEF500507K	32-44348T	253
CEF500508K	32-14358	253
CEF500508K	32-14358001	253
CEF500508K	32-14358T	253
CEF500509K	86840A05	299
CEF500509K	86840A3	299
CEF500509K	8M0062406	299
CEF500511K	32-90949T	253
CEF500512K	32734	300
CEF500512K	18654A1	300
CEF500512K	32734A3	300
CEF500513K	74639Q02	299
CEF500515K	816431A1	299
CEF500516K	60932A1	299
CEF500516K	60932A4	299
CEF500520K	78458	300
CEF500520K	78458A1	300
CEF500522K	36223	299
CEF500522K	36223A1	299
CEF500522K	36223A2	299
CEF500523	70981A3	253
CEF500524	53114	253
CEF500524	53114A1	253
CEF500524		219
CEF500524		253
CEF500532K	32-807458T	163
CHAPROSU		163
CHARJ12YC		163
CHARNSC		163
CHARS12PYP		163
CHARS12YC		163
CHARV15YC4		163
CHARV9IMC		163
CHAV63C		163
CM31640	31640A4	288
CM31640	31640Q4	263-267
CM31640A	31640A4	288
CM31640A	31640Q4	263-267
CM34127	34127T2	288
CM34127A	34127T2	288
CM34762	34762A1	288
CM34762A	34762A1	288
CM43994	43994A2	288
CM43994	821631A1	288
CM43994		108-109
CM46399	46399A1	288
CM46399	822777Q1	288
CM46399		109
CM46399A	46399A1	288
CM46399A	822777Q1	288
CM55989	55989A9	288
CM55989	55989Q9	288-291
CM55989A	55989A9	288
CM55989A	55989Q9	288
CM55989A		291
CM762144	76214-4	288
CM762144	76214A2	281
CM762144	76214Q5	283
CM762144		109
CM762144A	76214-4	288
CM762144A	76214A2	281
CM762144A	76214Q5	283
CM762145	76214A2	288
CM762145	76214Q5	275-270-288
CM762145A	76214A2	288
CM762145A	76214Q5	275-288
CM762145A	76514Q5	279

REF	OEM	
F		
CM76214Q5	76214Q5	109-288
CM806105	806105Q1	267-275
CM806105	806188A1	288
CM806105A	806105Q1	267-275
CM806105A	806188A1	288
CM806188	806188A1	109-279-281-283-288
CM806188A	806188A1	108-279-281-283-288
CM806189	806189Q1	288-307
CM806189A	806189Q1	288-307
CM806190	806190A1	308
CM806190	806190Q1	288
CM806190		109
CM806190A	806190A1	308
CM806190A	806190Q1	288
CM821629	821629Q1	109-269-271-288
CM821629A	821629Q1	269-271-288
CM821630	821630A1/Q1	288
CM821630	821630Q1	277
CM821630		109
CM821630A	821630A1/Q1	288
CM821630A	821630Q1	277
CM821631	43994A2	288
CM821631	821631A1	288
CM821631	821631Q	296
CM821631	821631Q1	291
CM821631A	43994A2	288
CM821631A	821631A1	288
CM821631A	821631Q	296
CM821631A	821631Q1	291
CM865182CA		289
CM865182CZ		109-289
CMALPHAGEN1KITA	888756Q02	256-263-267-289
CMALPHAGEN1KITM	888756Q02	263-267-289
CMALPHAKITA	888756Q01	289
CMALPHAKITA	888756Q03	289
CMALPHAKITA		257-269-271-275
CMALPHAKITM	888756Q01	289
CMALPHAKITM	888756Q03	289
CMALPHAKITM		262-271-275
CMBRAVO1KITA	888758Q01	279-289
CMBRAVO1KITM	888758Q01	279-289
CMBRAVO2Y3KITA	888761Q01	281-289
CMBRAVO2Y3KITM	888761Q01	281-289
CMBRAVO3KITA	888761Q02	283-289
CMBRAVO3KITM	888761Q02	283-289
CMC		289
CMCC		289
CMPNAA		289
CMPNAAZ		289
CMPNBA		289
CMPNBZ		289
CMPNCA		289
CMPNCF16A		289
CMPNCF16Z		289
CMPNDA		289
CMPNDAF14UNS		283-289
CMPNDAF14UNSA		283-289
CMPNDZ		289
CMPNZF14A		289
CMX-1	85538	288
CMX-1	823341	288
CMX-1A	85538	288
CMX-1A	823341	288

FEDV-1984	44182A1	217
FEDV-3929	75416	217
FEL17019		206
FEL17049		212-214
FEL17060		207-211
FEL17069		205
FEL17119		206
FEL17124		210
FEL17145		213-214
FEL17160		208
FEL17165		211
FEL17205		213
FEL17219		206
FEL17260		207-211
FEL17319	27-46401	225-252
FEL17360		208-211
FEL17420	27-33395	210-233-235-237-253
FEL17460	27-73866	253
FEL17725		209-210-216
FEL17740	26-75980	216-217
FEL17925		206
FEL17926		206
FEL17945		2

REF	OEM	
G		
GEGC15		136
GS30430		122
GS30431		122
GS30432		122
GS30433		122
GS31001		112
GS31002		112
GS31055		112
GS31056		112
GS31065		112
GS31066	22-89771Q2	112
GS31067		112
GS31157		112
GS38105	814263A1	303
GS38122	35852	303
GS38310	54-815504456	229-233
GS38320	815504272	231
GS38320	54-815504256	221-222-227-237-239
GS38320	54-815504272	233
GS38320	54-815504372	221
GS38320	54-815504456	229
GS38320		223
GS38322	54-815504372	221-227-230-237-239
GS90002		109
GS90012		109
GS90019		109
GS90090		109
GS90092		109

REF	OEM	
H		
HGE4870	73813A1	218-219-221-225-235-240-241-250
HGE4929	864929A3	229-233
HGE6351	76351A04	241
HOT20560-MK		241
HOT20905-MK		224
HOT20937	816219A5	242
HOT20937	98562A6	224-242-246-251
HOT20937-MK		224-242
HOT20950	77234A2	244
HOT20950	77234A7	235-244
HOT20950		250-253
HOT20952	99746A17	227-230-243
HOT20952	99746A3	243
HOT20952	99746A8	243
HOT20952-MK		226-227
HOT20956	806235A04	242
HOT20956	806867A8	242
HOT20956	860235A04	221
HOT20956	99798A18	242
HOT20956		248-250-253
HOT20956-MK		220
HOT20957-MK		239
HOT20958	65604A12	241-244
HOT20958	65604A4	244
HOT20958		250-253
HOT20962	65603A12	241-244
HOT20962	65603A3	244
HOT20962		250-253
HOT20970	98504A3	227-237-239-246
HOT20971	60426A1	246
HOT20971	76351A04	219-225-235-241-246
HOT20971	76351A2	246
HOT20971		251
HOT20975-MK		220-222-224
HOT20976-MK		226-227-236-237-238-239
HOT20978	76771A2	219-235-241
HOT20985	93322A12	249
HOT20985	93322A12AV	227-237-239
HOT20985		227-239
HOT26371-MK		219-225-235-241
HOT27214-MK		235-236-237
HOT28503-MK		226-227-236-237-238-239
HR TITAN		316

REF	OEM	
J		
JAB11979-0001	47-896332063	107-188
JAB17018-0001	47-816814T	107-188
JAB17937-0001-P	47-879194186	107-188
JOH09-1028B	47-801332602	188

REF	OEM	
L		
LENS3213	35-809097	111
LENS3227	35-886638	111
LENS3240		111
LEXOR		316
M		
MAG15-602	84-813720A8	167
MAG15-602	84-816761Q8	167
MAG15-803	84-816761A15	167
MAG15-803	84-816761A2	167

REF	OEM	
MAG15-803	84-816781A15	167
MAG15-809		167
MAR076	12076A2	221-222-245-251
MAR078	807078A6	244
MAR078	807078T09	244
MAR078	807078T10	239-244
MAR078	89011A8	244
MAR078		249-253
MAR246	860246A10	244
MAR246	860246A15	237-244
MAR246	860246A3	244
MAR246	860246A9	244
MAR246	87114A19	244
MAR246		249-253
MAR309	864309T01	245
MAR309	864309T02	229-233-245-251
MAR988	44354A3	245
MAR988	807914A1	245
MAR988	807988A03	227-230-237-239-245
MAR988	807988A2	245
MAR3320PAR	807476A6	248
MAR3320PAR	93320A13	227-237-239-248
MAR3320PAR	93320A5	248
MAR3320PAR		227-237-239
MAR591	864591T02	229-233-245-251
MAR612	864612T01	229-243-248-249-252
MAR735	864308T01	243
MAR735	865049T01	243
MAR735	865735A02	233-243
MAR746	99746A17	227-230-243
MAR746	99746A3	243
MAR746	99746A8	243
MAR746		249-252
MAR929	864929A3	229-248
MAR988	44354A3	245
MAR988	807914A1	245
MAR988	807988A03	227-230-237-239-245
MAR988	807988A2	245-251
MP0180-001	10-812509184	152
MP425024	824324	254
MP425024	824324T	254
MP425036	824330	254
MP425036	824330T	254
MP425113	59974	254
MP425113	811575	254
MP425113	811575T	254
MP425149	72608	254
MP425149	72608T	254
MP426422		133
MP426574		133
MP426766		134
MP514516	807729T	193
MP514516	8M0153706	193
MP514693	33863	193
MP514693	33863T	193
MP514720		193

REF	OEM	
N		
NEW SATURN		316
NGKBRP5EFS-13		105-164-166
NGKBRP6EFS		104-105-106-164-165-166
NGKBRP6ES		107-166
NGKBRP6ES		164
NGKBRP6ES		164
NGKBR6FS		104-105-106-164-165-166
NGKBR6FS		106
NGKBR6FS		164
NGKBR9ES		105-10-164-165-166
NGKTR4A15		107
NGKIZFR7M		166
NGKPZTR5A-15		107
NGKTR5IX		165
NGKTR5IX		104-105-106
NGKTR6IX		104-105-106

REF	OEM	
P		
PAF15-07010004	479452	229
PAGB/T93-10	41471	223-231
PAGB/T97-1-8	12-36001	192-261-265
PAGB/T848-6	12-29245	261-265
PRE30107		301
PRE30212		301
PRE3300C05	8M0082577	301
PRE3300C06	8M0082578	301
PRE3300C07	8M0082579	301
PRE3300C08	8M0082580	301
PRE3300C09	8M0082581	301
PRE3300C10	8M0082582	301
PRE3300C11	8M0082583	301
PRE3300C12	8M0082584	301
PRE3300C13	8M0082585	301
PRE3300C14	8M0082586	301
PRE3300C15	8M0082587	301

REF	OEM	
PRE3300C16	8M0082588	301
PRE3300C17	8M0082589	301
PRE3300C18	8M0082590	301
PRE3300C19	8M0082591	301
PRE3300C20	8M0082592	301
PRE3300C21	8M0082593	301
PRE3300C22	8M0082594	301
PRE3300C23	8M0082595	301
PRE3300C24	8M0082596	301
PRE3300C25	8M0082597	301
PRE3300C26	8M0082598	301
PRE3300C27	8M0082599	301
PRE3300C28	8M0082600	301
PRE3300C29	8M0082601	301
PRE3300C30	8M0082602	301
PRE3300C31	8M0082603	301
PRE3300C32		301
PRE3300C33		301
PRE3300C34	8M0082604	301
PRE3300C35		301
PRE3300C36	8M0082605	301
PRE3300C38	8M0082606	301
PRE3300C40		301
PRE3300C42		301
PRE3300C44		301
PRE3300C46		301
PRE3300C48		301
PRE3300C50		301
PRE53006	8M0082529	301
PRE53007	8M0082530	301
PRE53008	8M0082531	301
PRE53009	8M0082532	301
PRE53010	8M0082533	301
PRE53011	8M0082534	301
PRE53012	8M0082535	301
PRE53013	8M0082536	301
PRE53014	8M0082537	301
PRE53015	8M0082538	301
PRE53016	8M0082539	301
PRE53017	8M0082540	301
PRE53018	8M0082541	301
PRE53019	8M0082542	301
PRE53020	8M0082543	301
PRE53021	8M0082544	301
PRE53022	8M0082545	301
PRE53023	8M0082546	301
PRE53024	8M0082547	301
PREKM63706	8M0082479	301
PREKM63707	8M0082480	301
PREKM63708	8M0082481	301
PREKM63709	8M0082482	301
PREKM63710	8M0082483	301
PREKM63711	8M0082484	301
PREKM63712	8M0082485	301
PREKM63713	8M0082486	301
PREKM63714	8M0082487	301
PREKM63715	8M0082488	301
PREKM63716	8M0082489	301
PREKM63717	8M0082490	301
PREKM63718	8M0082491	301
PREKM63719	8M0082492	301
PREKM63720	8M0082493	301
PREKM63721	8M0082494	301
PREKM63722	8M0082495	301
PREKM63723	8M0082496	301
PREKM63724	8M0082497	301

REF	OEM	
R		
RAC1/2F-1/2M		123
RAC1/2X16		123
RAC1/2X18		123
RAC1/2X20		123
RAC1000MA30		117
RAC1000VMA		117
RAC120AS		118
RAC120R-RAC-01		111
RAC2010PM-OR		117
RAC2010SM-OR		117
RAC2010TM-OR		117
RAC2020PM-OR		117
RAC2020SM-OR		117
RAC2020TM-OR		117
RAC2040PM-OR		117
RAC2040SM-OR		117
RAC2040TM-OR		117
RAC230R2		118
RAC245R2		118
RAC3/8F-3/8M		123
RAC3/8X10		123
RAC3/8X12		123
RAC3/8X14		123
RAC31871	35-884380T	112
RAC31871	35-8M0020349	112
RAC31871	35-8M0060041	112
RAC31871		105
RAC320R-INOX-01		111
RAC320R-RAC-01		111
RAC320R-RAC-02		111
RAC460R2		118

REF	OEM	REF	OEM	REF	OEM
RAC490R2		REC11-34933		REC13524A1	13524A5 169
RAC500MA30		REC11-35921	11-35921	REC13524A1	13524T1 169-174
RAC75/1000MA30				REC13524A6	13524A4 169
RAC75/500MAX		REC11-52707Q1	11-52707Q1	REC13524A6	13524A6 169
RAC900MA30				REC13524A6	13524Q06 169-174
RAC900VMA		REC11-8267089	11-8267089	REC13524A6	19405A4 169
RACPF5510		REC11-859124	11-859124	REC13524A6	90576A4 169
RACR11T		REC11-859135	859135	REC1376-818622R02	1347-818622 133
RACR12		REC11-859135	11-859135	REC1376-818622R02	1347-8186221 133
RACR120P		REC11-859135	11-859135	REC1376-818622R02	1376-5659A1 133
RACR120SM		REC11-862902	11-862902	REC1376-818622R02	1376-5744A1 133
RACR120TM		REC11-862903	82671013	REC1376-818622R02	1376-6152A1 133
RACR12P		REC11-862903	11-134371	REC1376-818622R02	1376-818622R02 133
RACR12S		REC11-862907	11-862907	REC1376-818622R02	
RACR12T		REC11-863332	11-863332	REC1396-4148	1396-4148 142
RACR20P		REC11-8M0105210	11-8M0105210	REC1396-4656	1396-4656 138-141
RACR20S		REC1140639		REC1396-5238	1396-5222 139
RACR20T		REC11979-0001	47-896332063	REC1396-5238	1396-5238 139
RACR24P		REC12-18448	12-18448	REC1396-5238	
RACR24S		REC12-191833	12-19183-3	REC1397-2060	1397-2060 136-139-140-141
RACR24T				REC1397-2150	1397-2150 113
RACR25P		REC12-191833	12-191833	REC1397-3327	1397-3327 136
RACR25S				REC1397-3327	1397-8546 136
RACR25T		REC12-191833		REC1397-3327	1397-8959 136
RACR26P		REC12-20084	12-20084	REC1397-3327	139-140-141-142
RACR26S		REC12-27880	12-27880	REC1397-5831	1397-5831 139-141
RACR26T		REC12-31211Q03	12-31211A2	REC1397-6367A1	1397-6367A1 138
RACR60P		REC12-31211Q03	12-31211Q03	REC1397-8582	1397-8582 142
RACR60S		REC12-31266	12-31266	REC1397-8760	1397-8760 137
RACR60T		REC12-32666	12-32666	REC1397-8760	1397-7099 137
RACR90P		REC12-32834	12-32834	REC1397-8760	1397-8760 137
RACR90S		REC12-35777	12-35777	REC1397-8760	
RACR90T		REC12-39116	12-39116	REC1397-8760	
RACRK19492UL		REC12-44163	12-44163	REC1397-8760	1397-8545 112
RACRK20726		REC12-44164	12-44164	REC1397-8760	1397-8767 112
RACRK22628		REC12-45176	12-45176	REC1397-8760	1397-8767Q 112
RACS3213	35-809097	REC12-45176	12-45176	REC1398-3089	1398-3089 138
RACS3214	35-809099	REC12-45810	12-45810	REC13980	22-806608A1 219-221-222-249
RACS3220UL		REC12-46765	12-46765	REC14-18323	14-18323 267-275-279-281
RACS3227	35-886638	REC12-72498	12-72498	REC14-44166T1	17-44166T1 308
RACS3228UL		REC12-815472	12-815472	REC14-79447	14-79447 263
RACS3240		REC12-815952	12-815952	REC14034A3	14034A3 306
REC004		REC12-835467Q01	13171	REC14035A3	14035A3 306
REC016940	879194241	REC12-835467Q01	12-835467Q01	REC14505A2	14505A2 304
REC016940	35-815419	REC12-85058	12-85058	REC14587A7	14587A5 267-275
REC02644		REC12-90931	12-90931	REC1463-9382	38547 162
REC0307239	25-33504	REC120		REC1463-9382	32193A2 162
REC0987883		REC12110		REC1463-9382	392-806529A1 162
REC10-20518	10-20518	REC12120	46-96148A8	REC1463-9382	898253T24 162
REC10-28668	10-28668	REC12632A7	12632A7	REC15-32563A1	15-32563A1 259-269-271
REC10-28668	10-28668	REC12644A1	12644A1	REC15-35980A1	15-35980A1 259-269-271
REC10-30206	10-30206	REC12708	12708	REC15-36178A02	15-36178A02 269-271
REC10-30206	10-30206	REC12711	12711	REC15-36178A02	15-36178A02 259
REC10-31700	10-31700	REC12769-35150	35-19485	REC15-401	84-813720A5 167-176
REC10-32470	10-32470	REC12784	12784	REC15-402	84-813720A5 167
REC10-34354	10-34354	REC13-33734	13-33734	REC15-405	84-813720A13 167
REC10-35386	10-35386			REC15-405	84-816761Q13 173
REC10-37562	10-37562	REC13-35048	13-35048	REC15-405	
REC10-37612	10-37612			REC15-42637A1	15-42637A1 265-273
REC10-43749	10-43749	REC13-35048	21-20553	REC15-44491A1	15-44491A1 275
REC10-45590	10-45590	REC13-39107	13-39107	REC15-45691A1	15-45691A1 259-269
REC10-53728	10-53728	REC13-423511	13-42351-1	REC15-47397A1	15-47397A1 263-267-275
REC10-53728	10-53728	REC13-423511	13-423511	REC15-57007A1	15-57007A1 261
REC10-53728	8M2000229	REC13037	13037	REC15-601	84-813720A11 167
REC10-668631	668631	REC13037	8733261	REC15-601	84-816761Q16 173-174-176
REC10-668631	10-668631	REC13220	13220	REC15-604	84-813720A7 167
REC10-72094	10-72094	REC1347-816373A4	1347-816373A4	REC15-604	84-816761Q7 167
REC10-73657	10-73657	REC1347-816373A4	1347-7362A1	REC15-604	
REC10-76156	10-76156	REC1347-816373A4	1347-804624R02	REC15-606	84-863656A2 167-175
REC10-79953Q04	10-79953Q04	REC1347-816373A4	1347-816373A4	REC15-71013	15-71013 259-269-271
REC10-806290	10-806290	REC1347-816373A4	1347-8292A4	REC15-801	84-813720A10 167
REC10-806327	10-806327	REC1347-816373A4	1347-9415T	REC15-801	84-813720A8 167
REC10-816601	10-816601	REC1347-816373A4	1347-9662A4	REC15-801	84-813720A9 167
REC10-816928	10-816928	REC1347-816373A4	3310-804624R1	REC15-804	84-813720A2 167
REC10-85486	10-85486	REC1347-818619R02		REC15-804	84-813720A3 167
REC10-861788	10-861788	REC1347-818619R02	1336-3594A1	REC15-804	84-813720A4 167
REC10-865982005	10-865982005	REC1347-818619R02	1347-818619/R02	REC15-804	84-816761A15 167
REC10-86801	10-86801	REC1347-818619R02	1347-8186191	REC15-804	84-816761A2 167
REC10-90926	10-90926	REC1347-818619R02	1351-4263A1	REC15-804	84-816761A4 167
REC10-96411	10-96411	REC1347-818619R02	1351-4263A2/A3	REC15-804	84-816761Q17 173-174
REC10-97934	10-97934	REC1347-818619R02	1351-5202A1	REC15-804	84-816781A15 167
REC10-97934A1	10-97934A1	REC1347-818619R02	1351-6065A2	REC15-804	84-816781A4 167
REC10-98794	98794	REC1347-818619R02	1351-7354A1	REC15-804	84-818781A4 167
REC10-98794	10-98794	REC1347-9661A3		REC15-808	
REC10615K	47-879312025	REC1347-9661A3	1347-7361A1	REC15-813	84-863656A1 167-175
REC11-13436	11-13436	REC1347-9661A3	1347-7364A1	REC15-815	84-816608A1 167-175-176
REC11-22339	11-22339	REC1347-9661A3	1347-8296A4	REC15-86749A1	15-86749A1 279-281-283
REC11-34933	11-34933	REC1347-9661A3	1347-9661A3	REC15-92914A1	15-92914A1 279-281
REC11-34933	11-34933	REC1348-818621R02	1347-8186211	REC15000K	3349198 188
REC11-34933	11-34933	REC1348-818621R02	1347-818621R02	REC15000K	3916720 188
REC11-34933	11-34933	REC1348-818621R02	1348-818621/R02	REC15000K	47-853126 188
REC11-34933	11-34933	REC1348-818621R02	1351-8480A2	REC15000K	8M0056956 188
REC11-34933	11-859116	REC1348-818621R02		REC15000K	
		REC13524A1	13524A1	REC1547-815930A7	1547-815930A7 257-269-271

REF	OEM	REF	OEM	REF	OEM
REC1547-861063A10	1547-861063A10	REC17020		REC21990	
REC1547-861063A12	1547-861063A12	REC17030			305
REC1547-861063A6	1547-861063A6	REC17040		REC22-328022	22-328022
REC1547-861063A8	1547-861063A8	REC17042			221-227-237-239-240-241-249
REC1547-9412A20	1547-9412A20	REC17046		REC22-32803	22-32803
REC1547-9412A21	1547-9412A21	REC17048			222-224-249
REC1547-9412A22	1547-9412A22	REC17100	204-205	REC22-36382	22-36382
REC1547-9412A23	1547-9412A23	REC17102	205		219-221-227-237-239-249
REC1589-865440H50	1589-865440H50	REC17110	205	REC22-384071	22-384071
REC1589-865440H50	5-5231100NP	REC17116	206		221-227-235-237-239-240-249
REC1589-865440H50	5-5231100TP	REC17120	207	REC22-41622	22-41622
REC1589-865440H50	5-5231300NP	REC17125	206		221-227-235-237-239-240-249
REC1589-865440H50	5-5441100TP	REC17140	207	REC22-428611	428611
REC1589-865440H51	1589-865440H51	REC17146	208-210		231-234
REC1589-865440H51	5-5231200NP	REC17177A1	208-210	REC22-428611	22-428611
REC1589-865440H51	5-5231200TP	REC17177A1	213-214		224-227-229-233-237-239-259-296
REC1589-865440H51	5-5441200TP	REC17177A1	213-214	REC22-428611	22-428611
REC1589-865440H51	5-5441300TP	REC17177A1	213-214	REC22-67892A05	22-67892
REC1589-865440H51	5-5441600TP	REC17177A1	175	REC22-67892A05	22-8M0058389
REC1589-865440H52	1589-865440H52	REC17177A1	175		283
REC1589-865440H52	5-5121300TP	REC17177A1	175	REC22-67892A05	8M0058389
REC1589-865440H52	5-5441500TP	REC17200	204-205		263-267-275-277-279
REC1589-865440H52	5-5441700TP	REC17207	214	REC22-73379	73379
REC15995	15995	REC17210	206		108-109
REC15W40U3		REC17211	206	REC22-73379	22-73379
		REC17214	206		229-233-237-239-291
REC16-49545	16-49545	REC17220	209	REC22-73379	22-73379
		REC17224	208	REC22-860382	22-860382
REC16-56826	16-56826	REC17232	208		295
REC16-59579	16-59579	REC17240	209	REC22-861150T02	22-861150A1
REC16-70236	16-70236	REC17241	210		185-295-297
REC16-806300	16-806300	REC17242	210	REC22-861150T02	22-861150A2
REC16-97520	16-97520	REC17243	212		185
REC160ELEMENT		REC17246	212	REC22-861150T02	22-861150T02
REC1623-5356A4	1623-5356A4	REC17248	212		295-297
REC1623-815822A30	1623-815822A30	REC27-815528	212	REC22-862225	22-862225
REC1623-815822A30	1623-815822A6	REC17310	214		179
REC1623-815822A47	1623-815822A47	REC17320	223	REC22-863786A1	22-863786A1
REC1623-815822A47	5-5111200TP	REC17330	209-210		234
REC1623-815822A47	5-5111300TP	REC17340	213-214-254	REC22-863786A1	22-863786A1
REC1623-815822A47	5-5111400TP	REC17341	254		229
REC1623-815822A47	5-5111500TP	REC17341	213-214	REC22-866725	22-866725
REC1623-815822A53	1623-815822A32	REC17342	213		295-297
REC1623-815822A53	1623-815822A43	REC17494A1	180	REC22-866725	22-866725
REC1623-815822A53	1623-815822A53	REC1766160	119		221-224-229-233-235-237-239-241-241
REC1623-815822A53	1623-815823A5	REC17900	205	REC22-866725	22-866725
REC1623-815822A53	5-5121200TP	REC17903	205		112-223
REC1623-815822A53	5-5121300TP	REC17920	207	REC22-88847A1	22-88847A1
REC1623-815822A53	5-5121400TP	REC17921	207		290-291-296
REC1623-815822A53	5-5121500TP	REC17930	209-211	REC22-98477A2	22-98477A2
REC1623-815822A55	1623-815822A45	REC17931	209-211		179
REC1623-815822A55	1623-815822A55	REC17935	213-215	REC23-29804T	23-29804T
REC1623-8951A33	1623-8951A33	REC17937	213-215		261-265
REC1623-8951A33	5-5000147CP	REC17937-0001	47-879194186	REC23-30617A2	23-30617A2
REC1623-8951A33	5-5000162CP	REC17950	188		261-265
REC1623-8951A33	5-5000181CP	REC17970	205	REC23-32632	23-32632
REC1623-8951A33	5-5000194CP	REC17971	207		259
REC1623-8951A37	1623-8951A37	REC17980	207	REC23-47508T	23-47508T
REC1623-8951A43	1623-8951A43	REC17981	209-210		180
REC1623-8951A43	5-5010147CP	REC17982	209-210	REC23-67370	23-67370
REC1623-8951A43	5-5010162CP	REC18-32665	18-32665		23-67370
REC1623-8951A43	5-5010181CP	REC18-5953	155	REC23-805041A2	23-805041A2
REC1623-8951A43	5-5010194CP	REC18-8114	135		294-295-303
REC1656-8866A55	1656-8866A55	REC18-8115	135	REC23-806036A1	23-806036A1
REC1656-8866A55	5-5231100NP	REC18-8549	219		305
REC1656-8866A55	5-5231200NP	REC18525A1	18525A1	REC23-806922	23-806922
REC1656-8866A55	5-5231300NP	REC18643A7	18643A7		178-180
REC1656-8866A63	1656-8866A63	REC18654A1	32734	REC23-807073	23-807073
REC1656-8866A63	5-5121300TP	REC18654A1	300		308
REC1656-8866A63	5-5231100TP	REC18654A1	295-297-300	REC23-815921A21	23-815921A21
REC1656-8866A63	5-5231200TP	REC18654A1	300		273
REC1656-8M0046682	1656-8M0046682	REC18920A1	18920A1	REC23-8159501	23-8159501
REC1656-8M0046682	5-5441700TP	REC19-14842	19-14842		307
REC1656-8M0046733	1656-8M0046733	REC19-42682	19-42682	REC23-816583	23-816583
REC1656-8M0046733	5-5441100TP	REC19-47579	19-47579		257-273
REC1656-8M0046733	5-5441200TP	REC19-59504	19-59504	REC23-824108	23-824108
REC1656-8M0046735	1656-8M0046735	REC19-815951	19-815951		267-275
REC1656-8M0046735	5-5441300TP	REC19-864689	19-864689	REC23-847637	23-847637
REC1656-8M0046738	1656-8M0046738	REC195141	33266		293-298
REC1656-8M0046738	5-5441400TP	REC195141	52352	REC23-853853002	23-853853002
REC1656-8M0046738	5-5441500TP	REC195141	58231		217
REC1656-8M0046738	5-5441600TP	REC195141	62424	REC23-853855001	23-853855001
		REC195141	87581		217
REC16755Q1	16755Q1	REC195141	195141	REC23-861209A1	23-861209A1
		REC195141	87581T		276-277-297-303
REC16792A39	16792A39	REC21124849	879194363	REC23-89574	23-89574
REC17-14872A1	17-14872A1	REC21124852			23-89574
REC17-14873A1	17-14873A1	REC21310		REC23-8M8000506	92916
REC17-44166	17-44166	REC21370	17-14873A1		281
REC17-44167A1	17-44167A1	REC21380	17-14872A1	REC23-8M8000506	23-92916
REC17-47617	17-47617	REC21390			279-283
REC17-815953A01	17-815953A01	REC21470		REC23-90915	23-90915
REC17-8M0065070		REC21622232	879150A87		23-90915
REC17-8M0073409	17-8M0073409	REC21622232	884794A02	REC23-99291T	23-99291T
REC17-8M0073409	8M0073409	REC21622232	884794A1		306
REC17-8M0084681	8M0020941	REC21811		REC23-99299	23-99299
REC17000		REC21920			304
REC17010				REC23-99322	23-99322
					292-304
				REC24-17997A1	24-17997A1
					269-271-277
				REC24-30893	24-30893
					267-275
				REC24942	
					110
				REC24950	
					110
				REC25-16524	25-16524
					215
				REC25-16524	25-20415
					215
				REC25-20081	25-20081
					215
				REC25-21836	25-21836
					215-273
				REC25-25439	25-25439
					215-259-261-265-269-271
				REC25-29845	25-29845
					277
				REC25-30224	25-30224
					180
				REC25-30224Q	25-30224Q
					215
				REC25-30271	25-30271
					261-265
				REC25-30529	25-30529
					215
				REC25-30613	25-30613
					215-261-265
				REC25-31534	25-31534
					263-267-275-276-281
				REC25-32546	25-32546
					215-259-269-271
				REC25-33145	25-33145
					215-261
				REC25-33465	25-33465
					192-215-279-283
				REC25-33465	25-54029
					215
				REC25-33465	25-822370
					279-281
				REC25-35027	25-35027
					269-271-277
				REC25-35029	25-35029
					215
				REC25-36318	25-36318
					273
				REC25-38099	25-38099
					215-265
				REC25-38101	25-38101
					215
				REC25-38933	25-38933
					215

REF	OEM	REF	OEM	REF	OEM
REC25-457101	25-457101	REC26-892683	26-892683	REC27-856704	27-856704
REC25-48171	25-48171	REC26-897153	26-897153	REC27-856705	27-856705
REC25-55801	25-55801	REC26-8M0033407	26-8M0033407	REC27-856705	27-856705
REC25-62700	25-62700	REC26-8M0150312	26-8M0150312	REC27-858524	27-858524
REC25-62705	25-62705	REC26-8M0150312	26-8M0150312	REC27-863724Q	27-863724Q
REC25-62706	25-62706	REC26-8M2005029	26-8M2005029	REC27-863724Q	27-863724Q
REC25-62706	25-62706	REC26-90562	26-90562	REC27-863724Q	27-863724Q
REC25-62706	25-62706	REC26-90925	26-90925	REC27-8637251	27-8637251
REC25-67202	25-67202	REC26-94038	26-94038	REC27-8637251	27-8637251
REC25-70937	25-70937	REC26-965031	26-965031	REC27-8637251	27-8637251
REC25-80863	25-20863	REC2656613		REC27-863726	27-863726
REC25-811461	811461	REC26900		REC27-863726	27-863726
REC25-823683	25-823683	REC26901		REC27-863726	27-863726
REC25-87400A2	25-87400A2	REC26904		REC27-863726	27-863726
REC25-89497	25-89497	REC26905		REC27-863726	27-863726
REC25-8M0084884	25-26802	REC27-13709	27-13709	REC27-863726	27-863726
REC25-8M0084884	25-8071341	REC27-142471		REC27-863726	27-863726
REC25-8M0084884	25-8M0039163	REC27-14250	27-14250	REC27-863726	27-863726
REC25-8M0084884	8M0084884	REC27-18272	27-18272	REC27-864547A02	27-864547A02
REC25-90011	25-90011	REC27-33179Q02	27-33179Q02	REC27-864850A02	27-864850A02
REC25-94288	25-94288	REC27-33395	27-33395	REC27-89656-1	27-89656-1
REC25-97387	25-97387	REC27-33395	27-33395	REC27-89656-1	27-89656-1
REC25000		REC27-33395	8M2000819	REC27-8M0094247	24-8M0094247
REC25010		REC27-33918	27-8M2021920	REC27-8M0094247	27-801333454
REC25020		REC27-33956	27-33956	REC27-8M0094247	27-854129
REC25030		REC27-34213	27-34213	REC27-8M0094247	27-898101475
REC25W40U3		REC27-344861	27-34486-3	REC27-8M0094247	27-898101475
REC26-12224	26-12224	REC27-34897	27-34897	REC27-94914	27-94914
REC26-12709	26-12709	REC27-34898	27-34898	REC27-94996Q2	27-94996Q2
REC26-12709	26-12709	REC27-35898T	27-35898T	REC27-94996Q2	27-94996Q2
REC26-14240	26-14240	REC27-39915	27-39915	REC27-96429	27-96429
REC26-14756	26-14756	REC27-39917	27-39917	REC27-96429	27-96429
REC26-16709A2	26-16709A2	REC27-41609	27-41609	REC27-988231	27-988231
REC26-16977	26-16977	REC27-418122	27-418122	REC27-995061	27-995061
REC26-24590	26-24590	REC27-41812Q	27-41812Q	REC27-99757	27-99757
REC26-24590	26-24590	REC27-42457	27-42457	REC27-99757	27-99757
REC26-24590	26-24590	REC27-426311	27-42631-1	REC27-99777Q02	27-99777Q02
REC26-30913	26-30913	REC27-430331	27-430331	REC27-99777Q02	27-99777Q02
REC26-32511	26-32511	REC27-46820	27-46820	REC27-99777Q02	27-99777Q02
REC26-32511A1	26-32511A1	REC27-47510Q	27-47510Q	REC27-99960	27-99960
REC26-32911	26-32911	REC27-47590-1	27-47590-1	REC270	27-864547A02
REC26-33144A2	26-33144A2	REC27-47644-1	27-47644-1	REC270	27-864547A02
REC26-33467	26-33467	REC27-48042	27-48042	REC270	27-864549A02
REC26-34217	26-34217	REC27-480431	27-480431	REC270	27-864550A02
REC26-36556	26-36556	REC27-480431	27-480431	REC270	27-864550A02
REC26-36557	26-36557	REC27-48399	27-48399	REC28-30281	28-30281
REC26-38970	26-38970	REC27-48818Q01	27-48818Q01	REC28-8M0032833	28-8M0032833
REC26-419533	26-41953	REC27-49110	27-49110	REC294005	
REC26-43035	26-43035	REC27-49953	27-49953	REC296TWIN	
REC26-43036	26-43036	REC27-524572	27-524572	REC30-72961	30-72961
REC26-43993	26-43993	REC27-52546	27-52546	REC30-88957T	30-88957T
REC26-455771	26-45577 1	REC27-53045Q01	27-53045Q01	REC30-88957T	30-88957T
REC26-45587	26-45587	REC27-53045Q01	27-53045Q01	REC30-98475T1	30-98475T1
REC26-54925	26-54925	REC27-53354	27-53354	REC300-00879	392-7803A4
REC26-55682	25-55682	REC27-54014Q1	27-54014Q1	REC300-00879	392-805570A2
REC26-55682	26-55682	REC27-54506	27-54506	REC300-8M0044991	300-8M0044991
REC26-56397	26-56397	REC27-54529	27-54529	REC300-8M0044991	8M0029482
REC26-56788	26-56788	REC27-55810 1	27-55810 1	REC301967	25-36318
REC26-62818	26-62818	REC27-56108	27-56108	REC302035	25-48452
REC26-66302	26-66302	REC27-56880	27-56880	REC302537	25-33466
REC26-67388	26-67388	REC27-60208Q	27-60208	REC302588	25-26722
REC26-69188	26-69188	REC27-60715	27-60715	REC303347	25-26802
REC26-69189	26-69189	REC27-64692	27-64692	REC304174	25-32509
REC26-70081	26-70081	REC27-64818Q4	26-64818Q4	REC304454	13-69432
REC26-72785	26-72785	REC27-64818Q4	27-64818Q4	REC305123	25-33756
REC26-75624	26-75413	REC27-65577	27-65577	REC308627	25-20826
REC26-75624	26-75624	REC27-68714A6	27-68714	REC309731	25-29439
REC26-75988	26-75988	REC27-68715	27-68715	REC31-15842	31-15842
REC26-76868	26-14077	REC27-70142	27-70142	REC31-15844	31-15844
REC26-76868	26-76868	REC27-70905	27-70905	REC31-30894A1	31-30894A1
REC26-76868A04	26-76868A04	REC27-72479A5	27-72479A5	RM31-30894A5	31-30894A5
REC26-79831	26-79831	REC27-72805	27-72805	REC31-30895T	24-30893
REC26-805344	26-805344	REC27-73666	27-73666	REC31-30895T	31-30895T
REC26-807006	26-807006	REC27-74830	27-74830	REC31-32573A1	31-32573A1
REC26-811554	26-811554	REC27-803192A2	24-803192A2	REC31-32575T1	31-32575T1
REC26-8164641	26-816464-1	REC27-8052151	27-8052151	REC31-32575T1	31-32575T1
REC26-8164641	26-8164641	REC27-805396	27-805396	REC31-32575T1	31-32575T1
REC26-816575A2	26-816575A2	REC27-805760	27-805760	REC31-33138A1	31-33138A1
REC26-816575A3	26-816575A3	REC27-807218	27-807218	REC31-35928T1	31-35928T1
REC26-821092	26-821092	REC27-807473A1	27-807473A1	REC31-35988A12	31-35988A12
REC26-8219471	26-8219471	REC27-8079821	8079821	REC31-35990A1	31-35990A1
REC26-823894	26-823894	REC27-8079821	27-70143	REC31-36387A1	31-36387A1
REC26-861694	26-805080	REC27-8079821	27-701431	REC31-36387A1	31-36387A1
REC26-861694	26-861694	REC27-8079821	27-807982	REC31-53079A1	31-53079A1
REC26-864319	26-864319	REC27-8079821	27-8079821	REC31-54042T	31-54042T
REC26-88397	26-88397	REC27-8079821	27-8079821	REC31-61100A1	31-61100A1
REC26-88397A1	26-88397A1	REC27-8146801	27-8146801	REC31-66668A1	31-66668A1
REC26-88416	26-88416	REC27-815528	27-815528	REC31-66668A1	31-99328A1
REC26-89238	26-89238	REC27-8172771	27-8172771	REC31-66668A1	66668A1
REC26-89238	26-89238	REC27-850456	27-85046	REC31-66818A1	31-66818A1
REC26-892683	892683	REC27-856081	27-856081	REC31-814653T	31-814653
				REC31-815900	31-815900

REF	OEM		REF	OEM		REF	OEM	
REC3854190	50-56886	151	REC41641A8	41641A8	279-281	REC47820A1	47820	285
REC3854190	50-69865A1	151	REC41674T	41674T	296-297	REC47820A1AL	47820	285
REC3854260	3854260	173			227-229-231-233-237-239-291-296	REC48752T	48752T	261-265
REC3854261	811636	169	REC41802	41802		REC48952	48952	148
REC3854261	8116361	169	REC42419A1	42419A1	156	REC50-806965A4	50-806963A2	152
REC3854261	898253011	169	REC42419A1	862548A1	156	REC50-806965A4	50-806965A4	152
REC3854261	8M6001254	169	REC425062	807289A1	254	REC50-806965A4	50-863007A1	152
REC3854261	8M6001254	173	REC42600A09	42600A09	159	REC50-8M0090697	50-806965A2	152
REC3854311	804424	169	REC42600A09	42600A1	159	REC50-8M0090697	50-806965A4	152
REC3854311	850485	169	REC42600A09	42600A3	159	REC50-8M0090697	50-812429A2	152
REC3854311	850485	173	REC42600A09	42600A5	159	REC50-8M0090697	50-8M0090697	152
REC3854311	8504851	169	REC42724A3	42724A3	259	REC50-808011A05	50-808011A05	151
REC3854311	898253012	169	REC42785	42785	155	REC50-808011A05	50-80811A4	151
REC3854311	8M0062084	169	REC43-18411A2	43-18411A2	259-269	REC50-808011A05	50-88671A1	151
REC3854331	850484	168	REC43-18411A2	43-18411A4	259-268-269	REC50-863007A1	50-863007A1	151
REC3854331	3854331	173	REC43-45814A5	43-45814A5	259-269	REC50-8M0095471	50-8M0095471	151
REC3854331	393-3230	168	REC43-55778A3	43-55778A3	259-269	REC50-97499A2	50-47454	152
REC3854331	393-4988T	168	REC43-75325A3	43-75325A3	259-269	REC50-97499A2	50-65785A1	152
REC3854331	393-4988T2	168	REC43-818807	43-818807	174	REC50-97499A2	50-72550A2	152
REC3854331	393-9459Q1	168	REC43-828073A1	43-828073A1	267-275	REC50-97499A2	50-79604A3	152
REC3854331	850484T	168	REC43-853640A2	43-853640A2	271	REC50-99418A2	50-864340A2	151
REC3854331	850484T2	168	REC43-853641A2	43-853641A2	271	REC50-99418A2	50-99418A2	151
REC3854548	804418	168	REC43-853642A2	43-853642A2	271	REC500442		173
REC3854548	808483	168	REC43-853643A2	43-853643A2	271	REC500MA	35-850481	119
REC3854548	808483T	168	REC43-878087A2	43-878087A2	274-275	REC500MA	35-850481A1	119
REC3854548	808483T3	168	REC43-878617A2	43-853592A2	275	REC500MACON		122
REC3854549	808484	169	REC43436	43436	292-303	REC52-853594T	52-853594T	263-267-275
REC3854549	8084841	169	REC43713	43713	291-296	REC53-23720	53-23720	192
REC3854549	898253010	169	REC43994A2	43994	285	REC53-29641	53-29641	265-273
REC3854549	8M6001253	169	REC43994A2AL	43994	285	REC53-805272	53-805272	308
REC3854549	8M6001253	173	REC44-8146061	44-8146061	267	REC53-815949	53-815949	108-307
REC3854549	805224A1	145-149-150	REC44-8146061	8146061	275	REC53-88242	53-88242	279-281-283
REC3858261	805025A2	127	REC44-824110	44-824110	263-267-275	REC53114A1	53114	253
REC3858261	805656A2	127	REC44-850308	44-850308	275	REC53114A1	53114A1	219-225-253
REC3858261	805656A5	127	REC45-41939F1	45-41939F1	261			227-230-236-237-238-239-258
REC3858261	805656A6	127	REC45-42634	45-42634	265	REC53400		
REC3858261	861155A5	127	REC45-55796	45-55796	259	REC54-38863	54-38863	291-296-300
REC3858261	861155A6	127	REC45-557961	45-557961	269	REC54-815504320	54-815504320	108-291-296-300
REC3858462	57-45856	198	REC45-557961	45-557961	271	REC54-815504412	54-815504412	295
REC3858462	57-49213A1	198	REC45-816919	45-816919	273	REC54-86049	54-86049	295-297-300
REC3858462	57-93658Q	198	REC45-853648	45-853648	273	REC55005		314
REC3858462		105-195-196	REC45518A3	45518A3	295-302	REC55006		314
REC3858941	852956A1	130-149	REC45518T1	45518T1	295-302	REC55131A5	55131A5	178
REC3858984	GM10482803	162	REC45589A3	45589A3	295-302	REC55134		314
REC3859054	809463A1	151-152-157	REC46-44292Q03	46-44292Q03	189-265	REC55134		215
REC3859078	392-889925	161	REC46-48748T1	2495186	189	REC55989Q9	55989Q9	109-285-291
REC3860769	12449	153	REC46-48748T1	2763441	189	REC55989Q9AL	55989Q9	108-285
REC3860769	19685	153	REC46-48748T1	46-48748A1	189	REC55989Q9M	55989Q9	285
REC3860769	98555	153	REC46-64141A11	46-48748T1	189	REC57-13457Q	57-13457Q	105-195-196-198
REC3860769	817119	153	REC46-72774A32	46-64141A11	189-260-261	REC57-34359	57-34359	198
REC3860769	817119A1	153	REC46-72774A32	46-59112A2	187	REC57-34359	57-37619T,Q	198
REC3860769	817119A4	153	REC46-72774A32	46-63450A2	187	REC57-34359		105-195-196
REC3861267	392-881732	161	REC46-72774A32	46-72774A11	187	REC57-36356	57-36356	198
REC3861985	392-863704T	161	REC46-72774A32	46-73823A7	187	REC57-48122Q	57-48122Q	196-198
REC3861985	392-8M0054588	175	REC46-72774A32	46-807151A12	187	REC57-49043A1	57-49043A1	198
REC3861985	8M0054588	161	REC46-807151A14	46-807151A14	192	REC57-49043A1	57-64032Q1	198
REC3861985		162	REC46-807151A14	807151A14	191	REC57-49043A1		104-195
REC3863130	898141	146-175	REC46-807151A9	46-807151A9	186	REC57-52692	57-52692	198
REC387247	31-30956T	263-267-275	REC46-862914T10	46-862914T10	187	REC57-64416	57-49211	198
REC387817	31-42647A1	267-275	REC46-8M0113733	884727	185	REC57-64416	57-64416	198
REC3885317	50-864340A2	151	REC46-8M0113733	8M0113733	185	REC57-65607Q	57-65607T	104-195-198
REC39-74381A1	39-74381A1	217	REC46-8M0113733		187	REC57-78200Q1	57-78200Q1	196-198
REC391-5090	391-5090	170	REC46-8M0113734	8503991	185	REC57-807755Q04	57-807755Q04	197
REC391-5090	391-898253004	170	REC46-8M0113734	8M0113734	185	REC57-807755Q05	57-807755Q05	197
REC391-5090	8M6001250	170	REC46-8M0113734		187-193	REC57-816295Q	57-816295Q	104-195-196-198
REC391-5090		171-172	REC46-8M0113735	8504541	185-187-193	REC57-817113	57-817113	197
REC391-5090Q1	391-5090A1	170	REC46-8M0113736	883925	185	REC57-861049Q	57-861049Q	197
REC391-5090Q1	391-5090Q1	170	REC46-8M0113736	8M0113736	185	REC57-861757Q	57-861757Q	197
REC391-5090Q1		171-172	REC46-96148A8	46-60367A1	190	REC57-861758Q	57-861758Q	197
REC3916854	50-805991	152	REC46-96148A8	46-96148A5	190	REC57-861759Q	57-861759Q	197
REC392-6316	392-6316	176	REC46-96148A8	46-96148A8	190	REC57-865615Q01	57-865615Q01	197
REC392-6324Q1	392-6324A1	171	REC46-96148T1	46-96148T1	261-265	REC57-865615Q02	57-865615Q02	197
REC392-6324Q1	392-6324Q1	171	REC46020T02	46020T02	259-269	REC57-865615Q03	57-865615Q03	104-105-197
REC392-6324Q1	392-6324T1	171	REC46335	46335	219-221-222-224-225-227-235-237-239	REC57-865615Q04	57-865615Q04	104-105-197
REC392-6325Q1	392-6325A1	171	REC46335	11-46335	240-241	REC57-865615Q05	57-865615Q05	197
REC392-6325Q1	392-6325Q1	171	REC46399	46399	285	REC57-865615Q06	57-865615Q06	197
REC392-6325Q1	392-6325T1	171	REC46399AL	46399	285	REC57-865615Q07	57-865615Q07	197
REC392-6325Q1		171-172	REC47-43026Q02	47-43026Q02	109-188-273	REC57-865615Q08	57-865615Q08	104-105-197
REC392-6330	392-6330	176	REC47-43026Q06	47-43026Q06	108-190	REC57-865615Q10	57-865615Q10	197
REC392-9086T	392-9086	168	REC47-59362A4	47-59362A4	187-191	REC57-879150023	57-879150023	195
REC392-9086T	392-9086T	168	REC47-59362Q01	47-59362Q01	104-105-106-185-186-187-188-192	REC57-879172120	57-879172120	107-198
REC392-9766	392-9766	168				REC57-879194425	57-879194425	198
REC392-9766	392-9766Q1	168	REC47-59362Q08	47-59362Q08	191	REC57-879194425	57-898101624	198
REC392-9766	392-9766T	168	REC47-59362T5	47-59362T5	191	REC57-882531	57-882531	198
REC392-9766	F16900185	168	REC47-59362T6	47-59362T6	191	REC57-882531T	57-882531T	198
REC393-4988	393-3230	168	REC47-809866T	47-809866T	188	REC57-898101579	57-898101579	107-198
REC393-4988	393-4988	168	REC47-809866T	47-831311350	188	REC57-898101580		195
REC393-4988	393-4988T	168	REC47-862232A2	47-862232A2	188	REC57-8M0088876	57-8M0088876	197
REC393-4988	393-4988T2	168	REC47-862232A2	47-8M0104229	188	REC57-8M0093495	57-8M0093495	198
REC393831	393831	269-271-277	REC47-862232A2		104-105-106-107-187	REC57-8M0093495	8M0067268	198
REC393831	3938311	259	REC47-89984Q5	47-89984Q5	108-190-260-161-264-265	REC57-8M0097728	57-8M0097728	197
REC40005334	88751A02	175	REC47-89984T4	47-89984T4	108-188-261-265	REC57-8M0097728	57-8M0097728	197
REC40005334	888751A03	175	REC47441A1	47441A1	180	REC57-91035Q1	57-91035Q1	195-196-198
REC40005334	888751A1	175						
REC41400		147						

REF	OEM	REF	OEM	REF	OEM
REC57-96834Q		REC802632T	802632	REC814819A2	814819A2 259-269
REC58033	58033	REC802632T	802632T	REC814819A7	814819A7 271
REC58033	898253007	REC802632T		REC815303T	815303T 297
REC58217	58217	REC803148	803148	REC815407A2	13753A2 168
REC58217	898253008	REC803623001	803623001	REC815407A2	815407A2 168
REC58217	58217Q	REC803623001	811406	REC815407A2	815407Q02 168-174
REC58217	8M6001251	REC803623001	803623	REC815471T1	815471T1 109-300
REC59078Q3	59078Q3	REC804626R02	1347-6493A1	REC815919A1	815919A1 273
REC59501A1	59501A1	REC804626R02	1347-7363A1	REC815935A7	815935A7 307
REC59503	59503	REC804626R02	1347-7366A	REC815954A7	815954A7 307
REC59826A3	59826A3	REC804626R02	1347-804626R1	REC816431A1	816431A1 295
REC59830A7	59830A7	REC804626R02	1347-8288A1	REC816431A1	816431A1 299
REC59830A7	814819A3	REC804626R02	1347-8291A3	REC816431A1	
REC60207	60207	REC804626R02	804626R02	REC816597A1	816597A1 273
REC60252A2	60252A2	REC804626R02		REC816607	816607 295
REC60930	60930	REC805016A1	805016A1	REC816685	816685 295-302
REC60932A4	60932A1	REC805100	805100	REC8168112	8168112 259-269-271
REC60932A4	60932A4	REC805101T	805101T	REC817275Q05	817275Q05 109-191
REC60932A4		REC805185A3	805185A3	REC8172761	8172761 273
REC62092T	54552	REC805185A3	805185A37	REC817377	817377 173-176
REC62092T	62092	REC805185A36	805185A36	REC817377T	817377T 176
REC62092T	62092T	REC805222A1	805222A1	REC818349T1	818349T1 275
REC62092T		REC805223T	805223	REC818349T1	818349T1 263-267
REC621041	621041	REC805223T	805223T	REC818763A10	818763A10 275
REC64851	58034	REC805223T		REC818763A10	818763A10 263-267
REC64851	81-64851	REC805227A1	805227A1	REC821526001	821526001 273
REC64851		REC805298A1	805298A1	REC821629Q1	821629Q1 284-285
REC65057T1	65057A1	REC805298A1	85785-2	REC821629Q1AL	821629Q1 284-285
REC65057T1	65057T1	REC805298A1	85785T	REC821630Q1	821630Q1 284-285
REC65533A1	65533A1	REC805320A03	805320A03	REC821630Q1AL	821630Q1 284-285
REC65864	65864	REC805536A2	805536A2	REC821631Q1	821631Q1 284-285
REC65864	78016	REC805629A1	805629A1	REC821631Q1AL	821631Q1 108-109-284-285
REC65864		REC805759Q01	43557	REC823426A1	823426A1 139-140-141-142
REC65L-13915-00	808504	REC805759Q01	16457A4	REC823427A1	1397-2067 137
REC65L-13915-00	808504T1	REC805759Q01	43557A1	REC823427A1	1397-2634 137
REC65L-13915-00		REC805759Q01	805759A1	REC823427A1	1397-3459 137
REC65L-13915-00		REC805759Q01	805759A2	REC823427A1	1397-7542 137
REC66081A2	66081A2	REC805759Q01	805759A5	REC823427A1	1397-7542 137
REC681001	681001	REC805759Q01	805759A5	REC823427A1	1397-7547 137
REC69354A2	69354A2	REC805759Q01	805759Q01	REC823427A1	1397-8872 137
REC69729	56045	REC805759Q01	805759T1	REC823427A1	1397-8873 137
REC69729	59755	REC805759Q01	805759T2	REC823427A1	823427A1 137
REC69729	69729	REC805884T	90746A1	REC823427A1	
REC69729	78403A2	REC805884T	805884	REC823727	823727 139-140-141
REC70125A02	70125	REC805884T	805884T	REC824326002	
REC70125A02	70125A02	REC806034A1	866200A01	REC8245191	8245191 265-273
REC70125A02	70125A1	REC806105Q1	806105Q1	REC827682T	827682 126
REC70720		REC806105Q1AL	806105Q1	REC827682T	827682T 126
REC70817B	26-8M0050563	REC806188Q01	806188	REC828692A1	828692A1 269-271
REC70817B	26-97664	REC806188Q01AL	806188	REC828830A2	828830A2 275
REC70817B	26-976641	REC806189Q1	806189Q1	REC829207	57-48120Q1 104-105-195-196-198
REC70981A3	70981A3	REC806189Q1AL	806189Q1	REC834975	392-6326 169
REC71464A01	71464	REC806190Q1	806190Q1	REC834975	392-6326T 169
REC71464A01	72625	REC806190Q1AL	806190Q1	REC834975	F16900044 169
REC71464A01	71464A01	REC806191T	806191T	REC834975	
REC71831	64850	REC806490T	36525	REC835702	392-6318 168
REC71831	87-71831	REC806490T	806490	REC835702	392-6318T 168
REC71831		REC806490T	811091	REC835702	F16900184 168
REC73873A1	73873A1	REC806490T	806490T	REC84-817376T01	84-817376T01 173
REC74639Q02	74639Q02	REC806490T	97-257	REC84-819514T26	
REC75832T	75832T	REC806490T	97257A1	REC849899	849899 130-150
REC7614T1	76214	REC806612T	806612T	REC85060	85060 306-307-308
REC7614T1AL	76214	REC806673T1	806673T	REC8507522	8507522 302
REC76214Q5	76214Q5	REC806673T1	806673T1	REC8507522	8507522
REC76214Q5AL	76214Q5	REC807166A1	807166A1	REC8507522	+ 10-31700 292
REC762144	76214-4	REC807166A3	14348A1	REC852565	89-68258A4 157
REC762144AL	76214-4	REC807166A3	807166A3	REC852565	89-85365A41 157
REC76325A2	76325A2	REC807252Q3	807252Q3	REC853635	853635 271
REC76771A2	76771A2	REC807252Q4	807252Q4	REC853678T	853678 144
REC76771A2	76771A3	REC807252Q4	807252T4	REC853678T	853678T 144
REC76771A2		REC807252Q5	807252Q5	REC853998A1	853998 149-150
REC76850A2	76850A2	REC807652T	807652	REC853998A1	853998 131
REC76865	76865	REC807652T	807652T	REC853998A1	851956A1 131
REC77123	77123	REC807653T	807653	REC853998A1	853998A1 131
REC774811	774811	REC807653T	807653T	REC853998A1	853998T 131
REC78403A2	78402	REC807757T	807757T	REC854445	854445 144-150
REC78403A2	78403A1	REC807929A1	807929A1	REC855314	
REC78403A2	78403A32	REC807952A1	807952A1	REC855686	
REC78403A2	817119A4	REC807964A1	807964A1	REC85784A1	85784A1 142
REC78403A2	92497A3	REC807964A1	807964A1	REC85785A2	85785A2 142
REC78458A1	78458	REC807964A1	907964A1	REC86-865202T	86-865202T 158
REC78458A1	78458A1	REC808500	808500	REC860235A03	806867A12 243
REC78458A1		REC809064	809064	REC860235A03	806867A3 243
REC78984A08	78984A08	REC809065	809065	REC860235A03	860235A03 222-243-252
REC78984A08	78984A1	REC809065	823728	REC860349A1	860349A1 129-150
REC801766	801766	REC809065	835076	REC861126A1	861126A1 129-149-150
REC801767	801767	REC809066		REC861155A3	861155A2 127
REC801768	801768	REC809066	809066	REC861155A3	861155A3 127
REC802630T01	802630	REC80W90U6		REC861155A6	805025A2 127
REC802630T01	802630001	REC811534	811534	REC861155A6	805656A2 127
REC802630T01	802630T	REC811536T	811536	REC861155A6	805656A5 127
REC802630T01	802630T01	REC811536T	811536T	REC861155A6	805656A6 127
REC802630T01	8M0069803	REC811536T		REC861155A6	861155A5 127
REC802630T01		REC814604T1	814604A1	REC861155A6	861155A6 127
REC802630T01		REC814605	814605	REC861156A03	861156A03 129
				REC861156A04	861156A04 129

REF	OEM		REF	OEM		REF	OEM	
REC861156A1	861156A1	126	REC866169T01	866169Y01	128	REC898253013	884790	169
REC861249A1	861249	144	REC866170A01	866170A01	127-128	REC898253013	898253013	169
REC861249A1	861249A1	144	REC866779A1	86779A1	277	REC898253013	8M6001222	169-175
REC861249A1		149-150	REC86840A05	86840A05	297-299	REC898253013		169
REC861259	861259	142	REC86840A05	86840A3	299	REC89825302	898253029	169
REC861523A9	861523A9	303	REC86840A05	8M0062406	299	REC89825302	391-5088	169
REC861578	861578	292	REC86840A05		108-109	REC89825302	391-7057	169
REC861579	861579	186	REC87-18286A43	87-18286A43	160	REC89825302	391-7057T	169
REC861579	861579	192	REC87-19674A1	87-19674A1	160	REC89825302	8M6001224	169
REC861579	807731T	186	REC87-805605A1	87-805605A1	147	REC89825302	F16901224	169
REC861677T	818383T	124	REC87-808009A2	87-808009A2	292	REC89825302		171-172
REC861677T	861677T	124	REC87-808009A2	87-8M0052935	292	REC898253T22	884792	169
REC861677T		126	REC87-808009A2		292	REC898253T22	898253T22	169-175
REC862030T01	862030T	154	REC87-814281A5	87-814281A5	292	REC898253T23	888731	169
REC862030T01	862030T01	154	REC87-858679T2	87-858679T2	160	REC898253T23	898253T23	169-175
REC862031T1	862031T	153	REC87-859032T02	87-859032T02	160	REC8M0032834	28-8M0032834	261
REC862031T1	862031T	153	REC87-864252	87-864252	147	REC8M0032834	8M0032834	265
REC862031T1	862031T1	153	REC87-864252A01	87-864252A01	147	REC8M0042641	12-8M0042641	261
REC862048A1	97399	124	REC87-892150Q02	87-892150Q02	174	REC8M0042641	8M0042641	265
REC862048A1	812454A1	124	REC87-91941A8	87-91941A8	160	REC8M0047215	864650A05	128
REC862048A1	812454A3	124	REC87290A23	87290A26	177	REC8M0047215	864650A13	128
REC862048A1	862048A1	124	REC87290A4	87290A4	178-179-180	REC8M0047215	8M0047215	128
REC862048A1	97399A2	124	REC87399A2	87399A2	306	REC8M0047215		129
REC862048A1		125-126	REC87399A2	87399A2	308	REC8M0052939	814281A7	292
REC862077A1	41141A2	124	REC87399A2		306-308	REC8M0052939	889514A01	292
REC862077A1	862077A1	124	REC87399A3	87399A3	307	REC8M0052939	8M0052939	292
REC862077A1		125	REC87580		276-277-299	REC8M0052939		292-194
REC862132T	862132T	277	REC876037	8M0032176	158	REC8M0054726	881731	144
REC862209	862209	297	REC876037	8M0057697	158	REC8M0054726	8M0054726	144-150
REC862210A01	22-862210A01	227	REC879150054		107	REC8M0058164	97401	125
REC862210A01	22-862210A01	229	REC879150150	849934	144	REC8M0058164	8M0058164	125
REC862210A01	22-862210A01	230	REC879150150	879150150	144	REC8M0058164		125-126
REC862210A01	22-862210A01	237	REC879150150		150	REC8M0061068	47442A1	180
REC862210A01	22-862210A01	239	REC879172	879172	120	REC8M0061381	860256A4	178
REC862344A	47585	124	REC879172	896332162	120	REC8M0061381	861006A1	178
REC862344A	71327	124	REC879172		107	REC8M0061381	8M0061381	178
REC862344A	77594	124	REC879172259	879172259	152	REC8M0062102	32-8M0062102	198
REC862344A	86234	124	REC879172259	896332191	152	REC8M0062102	32-8M0062102	296
REC862344A	8623405	124	REC879194185	879194185	184	REC8M0062770	8M0062770	126
REC862344A	86234A3	124	REC879194371	882481	152	REC8M0062770	8M0062770	128
REC862344A	86234A4	124	REC879194371	879194371	152	REC8M0064021	834832	154
REC862344A		125-126	REC879194401	46-879194401	185	REC8M0064021	834832T2	154
REC862351T	862351T	187	REC879194401	8M0094406	185	REC8M0064021	857006A3	154
REC86246T	71646	124	REC879194401	8M6005225	185	REC8M0068784	34623	147
REC86246T	78485	124	REC879194401		187	REC8M0068784	90806	147
REC86246T	86246	124	REC879194401	879194401	302	REC8M0068784	815425	147
REC86246T	86246A1	124	REC88-79023T10	88-79023T10	158	REC8M0068784	87-815425T	147
REC86246T	86246T	124	REC88035	88035	306	REC8M0068784	8M0068784	147
REC86246T		125-126	REC881693002	881693002	130-150	REC8M0073435	842725A3	125
REC86247T	46860	124	REC881879T11	859210	147	REC8M0073435	861676A1	125
REC86247T	63196	124	REC881879T11	881879011	147	REC8M0073435	861676T09	125
REC86247T	78820	124	REC881879T11	859210T	147	REC8M0073435	8M0073435	125
REC86247T	86247	124	REC881879T11	859604A1	147	REC8M0073435		125
REC86247T	86247A2	124	REC881879T11	881879A6	147	REC8M0077616	805544T	145
REC86247T	86247T	124	REC881879T11	881879T11	147	REC8M0077616	8M0077616	145
REC86247T		125-126	REC882376	882376	116	REC8M0077616		150
REC862548A1	865380A13	156	REC88243A3	88243A3	279	REC8M0080805	8M0080805	291-296-306-307-308
REC862998	862998	145-149-150-223	REC88243A3	88243A3	281	REC8M0080805		290-296-306-307-308
REC863077T	863077T	154	REC88243A3	88243A3	283	REC8M0082988	828358	146
REC863077T	86307AR01	154	REC882571	882571	154	REC8M0082988	8283582	146
REC86310	16755Q1	277	REC882571	8M0084523	154	REC8M0082988	8M0030022	146
REC863802T2	863802T2	179	REC882687	882687	122	REC8M0082988	8M0082988	146
REC864244A2	864244A2	277	REC882687	35-8M0150917	122	REC8M0087834	885165	144
REC864281A2	864281A01	270	REC882751A04	821509	158	REC8M0087834	8M0087834	144
REC864281A2	864281A2	269-271	REC882751A04	821509T01	158	REC8M0089715	807252T1	182
REC864281A2	86481A2	271	REC882751A04	882751A04	158	REC8M0089715	8M0089715	182
REC864281A2	865491A01	271	REC883166A2	883166A2	156	REC8M0089715		104-105-106
REC864282T	864282T	271	REC885174	885174	130-149-150	REC8M0091470	807252T2	182
REC864297T01	864297	146	REC885176	885176	130-149-150	REC8M0091470	8M0091470	182
REC864297T01	864297001	146	REC889419	889419	117	REC8M0091470		104-105-106
REC864297T01	864297T01	146	REC889422	889422	117	REC8M0092849	8M0092849	160
REC864493	864493	104-105-106-181	REC89-818997A1	89-818997A1	157	REC8M0093480	8M0066646	181
REC864572	864572	112	REC89-818997A1	89-818997T1	157	REC8M0093480	8M0067292	181
REC864572	35-864572	112	REC89-818999A2	89-805188A1	157	REC8M0093480	8M0093480	181
REC864572		106	REC89-818999A2	89-818999A1	157	REC8M0093480		107
REC864625T	864625T	194	REC89-818999A2	89-818999A2	157	REC8M0093561	879194215	181
REC865193	865193	194	REC89-96054T	89-91975	157	REC8M0093561	879194231	181
REC865182Q01	865182	285	REC89-96054T	89-96054	157	REC8M0093561	879194233	181
REC865182Q01AL	865182	285	REC89-96158T	89-96054T	157	REC8M0093561	896332148	181
REC865329A02	865329A02	292-304	REC89-96158T	89-818864	157	REC8M0093561	8M0093561	181
REC865380A13	14336A20	155	REC89-96158T	89-818864T	157	REC8M0093561		107
REC865380A13	14336A8	155	REC89-96158T	89-96158T	157	REC8M0095310	8M0095310	146
REC865380A13	865380A13	155	REC891736T	17649	156	REC8M0095310	8M0095310	293
REC865380A13	865380A25	155	REC891736T	17649T	156	REC8M0095310	8M0095310	298
REC865380A13	88183A12	155	REC891736T	891736T	156	REC8M0095953	8M0095953	231
REC865380A25	14336A9	155	REC89260		254	REC8M0098619	889341	143
REC865380A25	414336A6	155	REC892615002	892615	146	REC8M0098619	8M0098619	143
REC865380A25	88183A12	155	REC892615002	892615001	146	REC8M0103289	8M0062771	127-128
REC865436A02	865436A02	292-300	REC892615002	892615002	146	REC8M0111642	898101425	193
REC865436A03		108-109-300	REC892617	892617	146	REC8M0111642	8M0111642	193
REC865437A02	865437A02	292-300	REC892681	892681	128	REC8M0113182	8183812	194
REC865496A02	865496A01	277	REC892681	892681	130	REC8M0125617	805226A1	144
REC865496A02	865496A02	271	REC892681		150	REC8M0125617	881070T	144
REC865503T	865503T	271	REC895207	895207	107-122-184	REC8M0125617	8M0125617	144
REC865876A01	865876A01	283	REC89632057	89632057	193	REC8M0125617		149-150-223
REC866169T01	866169A01	126	REC89690T	89690T	184	REC8M0133370	8M0057679	129
REC866169T01	866169T01	126	REC898101505	898101505	153	REC8M0133370	8M0133370	129

REF	OEM		REF	OEM		REF	OEM	
REC8M0133370		128	REC91-859046Q3		311	RM21325765	801331174	143
REC8M0142542	8M0142542	148	REC91-859046Q4		311	RM21325765	801763272	143
REC8M0142695	8M0095468	145-231	REC91-888863	91-888863	173	RM21325765	54-896332164	143
REC8M0142695	8M0142695	145	REC93320A15	93320A10	237-248	RM21325765	864148A01	143
REC8M0144930	8M0144930	160	REC93320A15	93320A15	248	RM21325765		143
REC8M0148530	8M0148530	186	REC93320A15		237	RM22-43828	22-43828T	296
REC8M0148668	885342001	148	REC934231	934231	263-267	RM22-49718	22-49718	305
REC8M0148668	885342002	148-231-234	REC934241	934241	263-267	RM22-861163	22-861163	185-295-297
REC8M0148668	8M0148668	148-223	REC93568	35-93568	113	RM23-815921A17	23-815921A17	272-273
REC8M0153706	807729T	193	REC94286T1	94286	285	RM23-816599	23-816599	291
REC8M0153706	8M0153706	193	REC94286T1AL	94286	285	RM23-847638	23-847638	298
REC8M0155633	897345016	186	REC94576	94576	192	RM23-87560091	23-87560091	277
REC8M0155633	8M0129714	186	REC94916	94916	192	RM23-87560094	23-87560094	277
REC8M0155633	8M0155633	186	REC94998A4	94998A4	259	RM23-87560097	23-87560097	277
REC8M2003959	8M2003959	145	REC966900	57-77274	195-198	RM23-98356	23-98356	291-296
REC8M2003959	8M2003959	231-234	REC966903	57-74271Q	195-196-198	RM23-983571	23-983571	291-296
REC8M2003959		223	REC966931	57-13458Q	196-198	RM23-99352	23-99352	293-298
REC8M2004414	8M2004414	231-234-251	REC96705A1	96705A1	219-242-248-	RM26-879194364		216
REC8M2011027	79448	281	REC97258A1	34625	250-252	RM27-864549A02	27-864549A02	252
REC8M2011027	8M2011027	263-267-275-	REC97258A1	97258	148	RM31-86763A04	31-86763A04	277
REC8M2015937	8M2015937	269-271	REC97258A1	97258A1	148	RM32-805375	32-805375	199-202
REC8M2015938	8M2015938	269-271	REC97258A1	F16900152	148	RM32-806209-1	32-806209-1	199
REC8M6000623	8818793	148	REC97258A1	F16900198	148	RM32-860144	32-860144	200-201
REC8M6000623	881879010	148	REC97432A2	97432A2	217-303	RM32-860331	32-860331	200
REC8M6000623	8M6000623	148	REC98-8M0121940	98-8M0121940	191	RM32-861057	32-861057	200
REC8M6000634	889659002	147	REC982209	391-5075	168	RM35-802893Q		110
REC8M6000634	897447002	147	REC982209	391-5075Q1	168	RM35-863829	35-863829	113
REC8M6000634	8M6000634	147	REC982209	F16900148	168	RM35-866340Q02	35-866340Q03	114
REC8M6001217	391-5092	170	REC98230A1	98230A1	293-298	RM35-866594Q01	35-866594K01	110
REC8M6001217	391-5093	170	REC98504A3	98504A3	227-234-239-	RM35-866594Q01	35-866594Q01	110
REC8M6001217	391-898253001	170	REC985218		251-267	RM35-883702Q	35-883702Q	114
REC8M6001217	8M6001217	170	REC985218		168	RM35-8M2001030	35-8M2001030	113
REC8M6001217	F16900040	170	REC98703A26	98703A26	308	RM41646A9	41646A9	297
REC8M6001217		171-172	REC98703A3	98703A3	306	RM42260A6	42260A6	291
REC8M6001219	392-6325	170	REC98704A26	98704A26	308	RM42815A6	42815A6	295
REC8M6001219	392-898253005	170	REC98704A3	98704A3	306	RM43-14063A1	43-14063A1	279-281
REC8M6001219	8M6001219	170	REC99155T2	99155T2	105-106-182-	RM43-66773A3	43-66773A3	259
REC8M6001219	F16900031	170	REC99356A2	99356A2	224	RM43-887903A1	43-887903A1	277
REC8M6001219		171-172	RECEFP-KT		184-253	RM43-887906A1	43-887906A1	277
REC8M6001249	392-6324	170	RECGREU1		127	RM43-887909A1	43-887909A1	277
REC8M6001249	392-898223002	170	RECGS00530		109	RM43881A14	8M0062568	291
REC8M6001249	8M6001249	170	RECGS01030	35-8M0067597	119-120	RM43881A17	43881A17	296
REC8M6001249	F169000083	170	RECHOL17-6		107-119-120	RM44-41630T	44-41630T	279-281
REC8M6001249	F16900023	170	RECHOL17-7		135	RM44-41630T	44-850308	279
REC8M6001249	F16900032	170	RECK309		135	RM44-865322T	44-865322T	283
REC8M6001249	F16900189	170	RECK591		228-229-233	RM44181A1	44181A1	217
REC8M6001249		171-172	RECK6325		228-229-233	RM44182A1	44182A1	217
REC8M6001252	898253009	169	RECK8503		226-227-236-	RM45-41629A2	41629A2	279
REC8M6001252	8M6001252	169			237-238-239	RM45-41629A2	45-41629A2	281
REC8M6002274		107			108-258-259-	RM45-41629A2	805370A1	283
REC8M6002428	8M0057686	130	RECKITMALPHA1AL	888756Q04	263-267-284-	RM45-812773T	45-812773T	277
REC8M6002428	8M6000652	130	RECKITMALPHA1M	888756Q04	286	RM46-807151A8	46-72774A69	185
REC8M6002428	8M6002428	130	RECKITMALPHA1ZN	888756Q04	284-286	RM46-807151A8	46-807151A8	185
REC8M6003194	878187	145	RECKITMALPHA2AL	888756Q03	284-286	RM52-865344A01	52-865344A01	277
REC8M6003194	8M6003194	145	RECKITMALPHA2M	888756Q03	108-109-269-	RM53-87843	53-87843	185-294-295-
REC8M6500024	865598	194	RECKITMALPHA2ZN	888756Q03	271-275-284-	RM53-87843		297
REC8M6500024	8M6500024	193	RECKITM BRAVO1AL		286	RM54-12078	54-12078	293-298
REC9-33301	885176	131-149-150	RECKITM BRAVO1AL	888758Q02	284-286	RM57-862054Q		104-195
REC9-33302	861260	131	RECKITM BRAVO1M	888758Q02	284-286	RM57410	57410	283
REC9-33302	861260T	131	RECKITM BRAVO1M	888758Q02	284-286	RM805182A1	805182A1	283
REC9-33302		149-150	RECKITM BRAVO1M	888758Q02	284-286	RM805322	805322	283
REC9-33303	805225A1	131-149-150	RECKITM BRAVO1M	888758Q02	284-286	RM806031A2	806031A2	295
REC9-33304	849896	131	RECKITM BRAVO1M	888758Q02	284-286	RM806034A2	806034A2	293-298
REC9-33304	802632T	131-150	RECKITM BRAVO1M	888758Q02	284-286	RM806193A48	19742A1	185
REC90095		310	RECKITM BRAVO23AL	888761Q03	109-281-284-	RM806193A48	19742A3	185
REC90301-ZW1-003	11-827614	263-267-275-	RECKITM BRAVO23M	888761Q03	286	RM806193A48	806193A20	185
REC90490	91-17257T	279	RECKITM BRAVO23M	888761Q03	284-286	RM806193A48	806193A38	185
REC90490	91-8053741	314	RECKITM BRAVO3AL	888761Q04	108-109-283-	RM806193A48	806193A48	185
REC90508-ZW1-003	14-816629Q	267-275-279	RECKITM BRAVO3M	888761Q04	284-286	RM807130A4	44266T	250
REC90508-ZW1-003	816629Q	263	RECKITM BRAVO3M	888761Q04	284-286	RM807130A4	44266T1	250
REC90736A24	90736A24	177	RECKITM BRAVO3ZN	888761Q04	284-286	RM807130A4	807130A4	227-229-233-
REC908855	26-20070	216	RECMC00001		189	RM807130A4		237-239-250
REC909140	25-58390	215	RECMC00002		189	RM807130A4	8M0115149	231-250
REC91-00001		310	RECMC00004	47-89984Q5	190	RM807371T1	807371T1	184
REC91-00002		310	RECOB BRACKET		110	RM815932	815932	269-271
REC91-12037	91-12037	313	RECPG260		151	RM817275A1	817275A1	273
REC91-17256	91-17256	314	RECPIN4		310	RM863444T1	863444T1	179
REC91-25034		292-311	RECPIN4.5		310	RM863457A2	863457A2	178
REC91-31107T	91-17275A1	313	RECPIN6		310	RM863631T1	863631T1	179
REC91-31229		313	RECRK21069		123	RM864363A1	864363A1	292
REC91-34569A1		310	RECSWK-2000/10		119	RM864364A1	864364A1	292
REC91-36569T	91-36569T	310	RECSWK-2000/5		119	RM865328A01	865328A01	293
REC91-37241		310	RECTOOLTRIM1		310	RM865425A03	865425A03	277
REC91-43506T		311	RECTOOLTRIM2		310	RM865470	865470	296
REC91-43579	91-43579	313	RECTOOLTRIM3		310	RM866136A01	866136A01	277
REC91-45497A1	91-45497A1	312	RECTOOLTRIMKIT		310	RM866322A01	866322A01	293-298
REC91-56048001	91-56048001	312	RM10-25299	10-824941	219-221-225-	RM86739	86739	283
REC91-56775T	91-56775T	312	RM10-28635	10-28635	235	RM86739	14-86739	279-281
REC91-60523	91-60523	312	RM10-807204	10-807204	293-298	RM86754T	86754T	283
REC91-60526T	91-60526T	312	RM11-49910	11-49910	293-298	RM88-79023A91	88-79023A91	158
REC91-61067A04		311	RM11-92004	11-92004	292	RM8M0052936	87-808009A1	292
REC91-61069T		311	RM12-41721	12-41721	277	RM8M0052936	87-808009A3	292
REC91-61077T	91-61077T	312	RM12-98548	12-98548	293-298	RM8M0052936	87-8M0052936	292
REC91-78310	91-78310	312	RM14801A1	14801A1	293-298	RM8M0052936		292
REC91-805475A1	91-805475A1	312	RM1656-8866A17	8866A64	233-237-249	RM8M0062440	8M0062440	298
REC91-818162	91-818162	312	RM19543A10	865436A02	279	RM91-17273	91-17273	313
			RM21325765	864148	292-300	RM91-17275A1	91-17275A1	313
					143			

REF	OEM	
RM91-17302	91-17302	313
RM91-31229A7		311
RM94989A6	94989A6	291
RM97351	97351	277
RM99356A1	99356A1	184
RM99438A1	99438A1	183
S		
SED3092000	805602A1	247
SED3092600	807988A03	239-247
SED3092600	807988A3	227
SED3092600		237
SED3092610	12076A2	247
SED3092610	12076A2	221-222
SED3093300	805602A2	247
SED3093301	80176320	247
SED3095400	864309T02	229-233-247
SED3095500	807988A03	247
SED3095500	864591T02	229-233
SHE10615K	47-879312025	107-186-188
SHE15000K	3349198	188
SHE15000K	3916720	188
SHE15000K	47-853126	188
SHE15000K	8M0056956	188
SHE15000K		107-186
SHE15979	47-808145T	186-191
SHE26000K	3972366	186-188
SHEG151	805835	186
SHEG155	806152	186
SHEG2603X		186
SHEP1016	854179001	186
SHEP1016	879312023	186
SHEP1016	8M0148530	186
SOL1511-142-23	48-78126A45	316
SOL1511-143-21	48-832834A45	316
SOL1511-145-19	48-832832A45	316
SOL1511-148-17	48-832830A45	316
SOL1511-150-15	48-832828A45	316
SOL1511-153-19	48-13700A46	316
SOL1511-153-21	48-13702A46	316
SOL1511-153-23	48-13704A46	316
SOL1511-155-17	48-18278A46	316
SOL1511-158-15	48-19838A46	316
SOL1511-160-13	48-78114A45	316
SOL1511-160-13	48-826072A46	316
SOL1512-153-19	48-13701A46	316
SOL1512-153-21	48-13703A46	316
SOL1512-155-17	48-90159A46	316
SOL1512-158-15	48-19841A46	316
SOL1513-140-21	48-832832A45	316
SOL1513-140-21	48-834854A45	316
SOL1513-140-23	48-832834A45	316
SOL1513-143-19	48-832830A45	316
SOL1513-143-19	48-834852A45	316
SOL1513-145-17	48-831850A45	316
SOL1513-145-17	48-832828A45	316
SOL1513-148-15	48-78116A4	316
SOL1514-140-21	48-834855A45	316
SOL1514-143-19	48-834853A45	316
SOL1514-145-17	48-834851A45	316
SOL1531-140-19	48-16316A46	316
SOL1531-140-19	48-832830A45	316
SOL1531-140-21	48-16318A46	316
SOL1531-140-21	48-832832A45	316
SOL1531-140-23	48-16320A46	316
SOL1531-140-23	48-832834A45	316
SOL1531-140-25	48-16322A46	316
SOL1531-140-25	48-78126A45	316
SOL1531-143-17	48-16314A46	316
SOL1531-143-17	48-832828A45	316
SOL1531-145-15	48-16312A46	316
SOL1531-145-15	48-78116A4	316
SOL1531-156-13	48-78114A45	316
SOL1532-140-19	48-16317A46	316
SOL1532-140-21	48-16319A46	316
SOL1532-140-23	48-16321A46	316
SOL1532-143-17	48-16315A46	316
SOL1551-140-24	48-16322A46	316
SOL1551-140-24	48-16550A46	316
SOL1551-143-22	48-16320A46	316
SOL1551-143-22	48-16548A46	316
SOL1551-145-21	48-16546A46	316
SOL1551-148-16	48-16314A46	316
SOL1551-148-18	48-16316A46	316
SOL1551-148-19	48-16544A46	316
SOL1551-148-20	48-16318A46	316
SOL1552-140-24	48-16549A46	316
SOL1552-143-22	48-16321A46	316
SOL1552-143-22	48-16547A46	316
SOL1552-145-21	48-16545A46	316
SOL1552-148-16	48-16315A46	316
SOL1552-148-18	48-16317A46	316
SOL1552-148-19	48-16543A46	316
SOL1552-148-20	48-16319A46	316
SOL1571-145-25	48-13706A46	316
SOL1571-148-23	48-13704A46	316
SOL1571-150-21	48-13702A46	316
SOL1571-153-19	48-13700A46	316

REF	OEM	
SOL1571-155-17	48-18278A46	316
SOL1572-145-25	48-13707A46	316
SOL1572-148-23	48-13705A46	316
SOL1572-150-21	48-13703A46	316
SOL1572-153-19	48-13701A46	316
SOL1572-155-17	48-90159A46	316
SOL1611-178-21	48-18616A40	316
SOL1611-178-21	48-18616A6	316
SOL1611-183-19	48-18614A40	316
SOL1611-183-19	48-18614A6	316
SOL1611-188-17	48-18612A40	316
SOL1611-188-17	48-18612A6	316
SOL1611-193-15	48-18610A40	316
SOL1611-193-15	48-18610A6	316
SOL1612-178-21	48-18617A40	316
SOL1612-178-21	48-18617A6	316
SOL1612-183-19	48-18615A40	316
SOL1612-183-19	48-18615A6	316
SOL1612-188-17	48-18613A40	316
SOL1612-188-17	48-18613A6	316
SOL1612-193-15	48-18611A40	316
SOL1612-193-15	48-18611A6	316
SOL1641-173-25	48-18620A6	316
SOL1641-175-23	48-18618A40	316
SOL1641-175-23	48-18618A6	316
SOL1641-175-23	48-18620A40	316
SOL1641-178-21	48-18616A40	316
SOL1641-178-21	48-18616A6	316
SOL1641-183-19	48-18614A40	316
SOL1641-183-19	48-18614A6	316
SOL1641-188-17	48-18612A40	316
SOL1641-188-17	48-18612A6	316
SOL1641-193-15	48-18610A40	316
SOL1641-193-15	48-18610A6	316
SOL1642-173-25	48-18621A40	316
SOL1642-173-25	48-18621A6	316
SOL1642-175-23	48-18619A40	316
SOL1642-175-23	48-18619A6	316
SOL1642-178-21	48-18617A40	316
SOL1642-178-21	48-18617A6	316
SOL1642-183-19	48-18615A40	316
SOL1642-183-19	48-18615A6	316
SOL1642-188-17	48-18613A40	316
SOL1642-188-17	48-18613A6	316
SOL1642-193-15	48-18611A40	316
SOL1642-193-15	48-18611A6	316
SOL1651-138-28		317
SOL1651-140-24		317
SOL1651-140-25		317
SOL1651-140-26		317
SOL1651-140-27		317
SOL1651-143-22		317
SOL1651-143-23		317
SOL1651-144-20		317
SOL1651-144-21		317
SOL1654-150-28		317
SOL1654-155-24		317
SOL1654-155-25		317
SOL1654-155-26		317
SOL1654-155-27		317
SOL1654-158-22		317
SOL1654-158-23		317
SOL1654-160-20		317
SOL1654-160-21		317
SOL9511-143-21		317
SOL9511-145-19		317
SOL9511-148-17		317
SOL9511-150-15		317
SOL9511-153-13		317
SOL9512-143-21		317
SOL9512-145-19		317
SOL9512-148-17		317
SOL9512-150-15		317
SOL9513-140-21		317
SOL9513-143-19		317
SOL9513-145-17		317
SOL9513-148-15		317
SOL9531-140-19		317
SOL9531-140-21		317
SOL9531-140-23		317
SOL9531-143-17		317
SOL9531-145-15		317
SOL9532-140-19		317
SOL9532-140-21		317
SOL9532-140-23		317
SOL9532-143-17		317
SOL9532-145-15		317
SOL9571-145-25		317
SOL9571-148-23		317
SOL9571-150-21		317
SOL9571-153-19		317
SOL9571-155-17		317
SOL9571-158-15		317
SOL9572-145-25		317
SOL9572-148-23		317
SOL9572-150-21		317
SOL9572-153-19		317
SOL9572-155-17		317

REF	OEM	
SOL9572-158-15		317
SOLRBX-102		317
T		
TEN00800	1301339	286
TEN00806BIS	821521	286
TEN00807	55989	286
TEN00814	821629	286
TEN00815	821630	286
TEN00817	806189	287
TEN00818	806190	287
TEN00819	806105	287
TEN00820	76214-5	286
TEN00823	823912	286
TEN00824	823913	286
TEN00827	17264	286
TEN00839	853762	287
TEN01320T	811487	287
TEN01320T	879194217	287
TEN01320T	8M0067062	287
TEN01320T	8M0067625	287
TEN01320T	8M0150234	287
TEN01320T	97-8M0151541	287
TEN01320T		107-183
TEN02040		287
TEN02041		287
TEN02042		287
TEN02043		287
TEN02043T		287
TEN02044		287
TEN02044T		287
TEN02044TP		287
TENKITALPHAONE/1	8887562Q02	263-267-287
TENKITALPHAONE/2	888756Q01	287
TENKITALPHAONE/2	888756Q03	287
TENKITALPHAONE/2		269-171-175
TENKITBRAVOI	888758Q01	279-287
TENKITBRAVOII-III	888761Q01	281-287
TENKITBRAVOIII-04	888761Q02	283-287
TRANSONALPHA2G	6-6111002LP	291
TRANSONALPHA1	6-6010000CP	291
TRANSONBRAVO	6-6211002NZ	298
TRANSONBRAVO	6-6311002NZ	298

OEM --> REF

OEM	REF	PAG.	OEM	REF	PAG.	OEM	REF	PAG.
6325	REC33662	170	62898	BAMC29-62898	180	807652	REC807652T	154
12449	REC3860769	153	63196	REC86247T	124	807653	REC807653T	154
12708	REC12708	277	64850	REC71831	170	808483	REC3854548	168
12711	REC12711	277-302	65864	REC65864	169	808484	REC3854549	169
12784	REC12784	277	69729	REC69729	153	808500	REC808500	129
13037	REC13037	157	70125	REC70125A02	142	808504	REC65L-13915-00	113
13171	REC12-835467Q01	281	71327	REC86234A4	124	809064	REC809064	138-140-141
13220	REC13220	138	71464	REC71464A01	142	809065	REC809065	138
15995	REC15995	148-224	71646	REC86246T	124	809066	REC809066	142
17264	TEN00827	286	72608	MP425149	254	811091	REC806490T	148
17649	REC891736T	156	72625	REC71464A01	142	811406	REC803623001	160
19685	REC3860769	153	73379	REC22-73379	231-234	811461	REC25-811461	143
25661	REC378444	157	75416	FEDV-3929	217	811487	TEN01320T	287
32734	CEF500512K	300	75832	REC3850812	277	811534	REC811534	136-140-141-142
32734	REC18654A1	300	76214	REC76141T	285	811536	REC811536T	136
33266	REC195141	176	76214	REC76141T1AL	285	811575	MP425113	254
33662	REC33662	170	76214-4	REC762144	285	811636	REC3854261	169
33700	REC33700	170	76214-4	REC762144AL	285	811637	REC3854003	162
33706	REC33706	170	76865	REC76865	263-267-275	811639	REC3854001	145
33708	REC33708	168	77123	REC77123	293	814605	REC814605	275
33765	REC33765T	168	77594	REC86234A4	124	815425	REC8M0068784	147
33863	MP514693	193	78016	REC65864	169	815932	RM815932	269-271
34127	REC34127T2	285	78402	REC78403A2	153	816607	REC816607	295
34127	REC34127T2AL	285	78458	CEF500520K	300	816685	REC816685	295-302
34235	REC34235T	170	78458	REC78458A1	300	817119	REC3860769	153
34623	REC8M0068784	147	78485	REC86246T	124	817377	REC817377	173-176
34625	REC97258A1	148	78820	REC86247T	124	817378	REC3854003	161
35852	GS38122	303	79448	REC8M2011027	281	821509	REC882751A04	158
35915	REC35915	263	85060	REC85060	306-307-308	821521	TEN00806BIS	286
35983	REC35983	259	85538	CMX-1	288	821629	TEN00814	286
35983	REC35983	269	85538	CMX-1A	288	821630	TEN00815	286
35983	REC35983	271	86234	REC86234A4	124	823341	CMX-1	288
36223	CEF500522K	299	86246	REC86246T	124	823341	CMX-1A	288
36223	REC36223A2	299	86247	REC86247T	124	823727	REC823727	136-140-141
36525	REC806490T	148	86739	RM86739	283	823728	REC809065	138
38547	REC1463-9382	162	87581	REC195141	176	823912	TEN00823	286
39916	BAMC47-27-39923	250	88035	REC88035	306	823913	TEN00824	286
39920	BAMC-20-55538	245	90806	REC8M0068784	147	824324	MP425024	254
41471	PAGB/T93-10	231	92916	REC23-8M8000506	281	824330	MP425036	254
41802	REC41802	227	94286	REC94286T1	285	827682	REC827682T	126
41802	REC41802	229	94286	REC94286T1AL	285	828151	REC3854138	158
41802	REC41802	233	94576	REC94576	192	828358	REC8M0082988	146
41802	REC41802	237	94916	REC94916	192	834832	REC8M0064021	154
41802	REC41802	239	97258	REC97258A1	148	835076	REC809065	138
41802	REC41802	291	97351	RM97351	277	849896	REC9-33304	131
41802	REC41802	296	97399	REC862048A1	124	849899	REC849899	130-150
42785	REC42785	155	97401	REC8M0058164	125	849934	REC879150150	144
43436	REC43436	292-303	98555	REC3860769	153	850484	REC3854331	168
43557	REC805759Q01	168	98794	REC10-98794	231	850485	REC3854311	169
43713	REC43713	291-296	99757	REC27-99757	231	850485	REC3854311	173
43994	REC43994A2	285	195141	REC195141	176	850487	REC3854003	162
43994	REC43994A2AL	285	324351	REC324351	261-265	853635	REC853635	271
46335	REC46335	219-221-222-224-225-227-235-237-239	393831	REC393831	269	853678	REC853678T	144
46399	REC46399	285	393831	REC393831	271	853762	TEN00839	287
46399	REC46399AL	285	428611	REC22-428611	231-234	853998	REC853998A1	131
46860	REC86247T	124	479452	PAF15-07010004	229	854445	REC854445	144-150
47585	REC86234A4	124	621041	REC621041	259-295-302	859135	REC11-859135	194-269
47587	BAMC29-47587	177	668631	REC10-668631	231-234	859210	REC881879T11	147
47735	BAMC1-47735	244	681001	REC681001	267-275	860231	REC27-8637251	251
47736	BAMC1-47736	244	774811	REC774811	261-265	861249	REC861249A1	144
47820	REC47820A1	285	801766	REC801766	171	861259	REC861259	142
47820	REC47820A1AL	285	801767	REC801767	171	861260	REC9-33302	131
48952	REC48952	148	801768	REC801768	171	861578	REC861578	292
52352	REC195141	176	802464	REC802464	162	861579	REC861579	186
53051	REC27-53045Q01	181	802630	REC802630T01	129	861579	REC861579	192
53114	CEF500524	253	802632	REC802632T	130	862031	REC862031T1	153
53114	REC53114A1	253	803148	REC803148	144-149-150	862209	REC862209	297
54552	REC62092T	124	803149	REC3843751	145-149-150	862646	BS5292	159
55989	TEN00807	286	803623	REC803623001	160	862647	BS5294	159
56045	REC69729	153	804412	REC3854003	162	862998	REC862998	145
56153	REC3853847	217	804418	REC3854548	168	863725	REC27-8637251	251
57410	RM57410	283	804424	REC3854311	169	864148	RM21325765	143
58033	REC58033	170	805100	REC805100	283	864297	REC864297T01	146
58034	REC64851	170	805218	REC3850397	148	864493	REC864493	181
58217	REC58217	169	805223	REC805223T	148	864572	REC864572	112
58231	REC195141	176	805322	RM805322	283	865182	REC865182Q01	285
59498	BAMC29-59498	180	805835	SHEG151	186	865182	REC865182Q01AL	285
59503	REC59503	191	805884	REC805884T	153	865193	REC865193	194
59755	REC69729	153	806105	TEN00819	287	865470	RM865470	296
59974	MP425113	254	806152	SHEG155	186	865598	REC8M6500024	194
60207	REC60207	235-241	806188	REC806188Q01	285	866725	REC22-866725	231-234
60565	REC35-06007	114	806188	REC806188Q01AL	285	878187	REC8M6003194	145
60930	REC60930	253	806189	TEN00817	287	879172	REC879172	120
62092	REC62092T	124	806190	TEN00818	287	881731	REC8M0054726	144
62424	REC195141	176	806490	REC806490T	148	882376	REC882376	116
						882481	REC879194371	152

OEM	REF	PAG.	OEM	REF	PAG.	OEM	REF	PAG.
882571	REC882571	154	881693002	REC881693002	130-150	11-862907	REC11-862907	283
882687	REC882687	122	881879010	REC88M6000623	148	11-863332	REC11-863332	304
882751	REC3854138	158	881879011	REC881879T11	147	11-8M0105210	REC11-8M0105210	283
883885	REC3853796	186-187	885342001	REC8M0148668	148	11-92004	RM11-92004	277
883925	REC46-8M0113736	185	885342002	REC8M0148668	148-231-234	12-18448	REC12-18448	275
884727	REC46-8M0113733	185	889659002	REC8M6000634	147	12-19183-3	REC12-191833	283
884790	REC898253013	169	892615001	REC892615002	146	12-191833	REC12-191833	259-263-267-269-271-275-277-279-281
884792	REC898253T22	169	892615002	REC892615002	146	12-20084	REC12-20084	192-219-221-222
885165	REC8M0087834	144	896332057	REC896332057	193	12-27880	REC12-27880	261-265
885174	REC885174	130-149-150	896332148	REC8M0093561	181	12-29245	PAGB/T848-6	261-265
885176	REC885176	130-149-150	896332162	REC879172	120	12-31211A2	REC12-31211Q03	275
885176	REC9-33301	131-149-150	896332191	REC879172259	152	12-31211Q03	REC12-31211Q03	263-267-279
888731	REC898253T23	169	897345016	REC8M0155633	186	12-31266	REC12-31266	261-265
889333	BAMC29-63588	178	897447002	REC8M6000634	147	12-32666	REC12-32666	259-295
889341	REC8M0098619	143	898101425	REC8M0111642	193	12-32834	REC12-32834	304
889419	REC889419	117	898101505	REC898101505	153	12-35777	REC12-35777	304
889422	REC889422	117	898253003	REC33662	170	12-35935	REC12-45176	269-271-295-297
892615	REC892615002	146	898253005	REC33662	170	12-36001	PAGB/T97.1-8	192-261-265
892617	REC892617	146	898253007	REC58033	170	12-39116	REC12-39116	295
892665	REC35-892665	128	898253008	REC58217	169	12-41721	RM12-41721	293-298
892681	REC892681	128	898253009	REC8M6001252	169	12-44163	REC12-44163	306-308
892681	REC892681	130	898253010	REC3854549	169	12-44164	REC12-44164	308
892683	REC26-892683	128	898253011	REC3854261	169	12-45176	REC12-45176	257-283
895207	REC895207	107-122-184	898253012	REC3854311	169	12-45810	REC12-45810	259-269-271
898141	REC3863130	146-175	898253013	REC898253013	169	12-46765	REC12-46765	305
934231	REC934231	263-267	898253029	REC89825302	169	12-72498	REC12-72498	295
934241	REC934241	263-267	10-20518	REC10-20518	292-303	12-815472	REC12-815472	292
1301339	TEN00800	286	10-28635	RM10-28635	293-298	12-815952	REC12-815952	307
2495186	REC46-48748T1	189	10-28636	REC10-28668	291	12-835467Q01	REC12-835467Q01	263-267-275-279
2763441	REC46-48748T1	189	10-28668	REC10-28668	259-271	12-85058	REC12-85058	306
3349198	CEF500167	188	10-28688	REC10-28668	269	12-8M0042641	REC8M0042641	261
3349198	REC15000K	188	10-30206	REC10-30206	263-267	12-90931	REC12-90931	174
3349198	SHE15000K	188	10-31700	REC10-31700	292-302	12-92721	REC350038	267
3581760	REC3581760	117	10-32470	REC10-32470	263-267	12-92721	REC350038	275
3854260	REC3854260	173	10-34354	REC10-34354	221	12-98548	RM12-98548	293-298
3854331	REC3854331	173	10-35386	REC10-35386	219-235-240-241	12076A2	MAR076	221-222-245-251
3854548	REC3854548	173	10-37562	REC10-37562	225	12076A2	SED3092610	247
3916720	CEF500167	188	10-37612	REC10-37612	239-240-241	12076A2	SED3092610	221-222
3916720	REC15000K	188	10-37612	REC10-37612	227-229-233-237-239	12632A7	REC12632A7	304
3916720	SHE15000K	188	10-43749	REC10-43749	227-229-233-237-239	12644A1	REC12644A1	254
3938311	REC393831	259	10-45590	REC10-45590	295-302	13-33734	REC13-33734	304
3972366	CEF500183G	188	10-53728	REC10-53728	221-222	13-35048	REC13-35048	221-224-227-229-233-235-237-239-240-241-277
3972366	SHE26000K	186-188	10-53728	REC10-53728	221-222	13-39107	REC13-39107	224
8079821	REC27-8079821	137	10-668631	REC10-668631	221	13-42351-1	REC13-423511	263-279
8084841	REC3854549	169	10-72094	REC10-72094	221	13-423511	REC13-423511	267-275
8085041	REC65L-13915-00	113	10-73657	REC10-73657	224	13-69432	REC304454	307-308
8116361	REC3854261	169	10-74727	REC22-73379	224	1336-3594A1	REC1347-818619R02	133
8168112	REC8168112	259-269-271	10-76156	REC10-76156	263-267	13447A1	REC17177A1	175
8172761	REC8172761	273	10-79953Q04	REC10-79953Q04	259-269-271	1347-6492A1	REC1347-816373A4	134
8183812	REC8M0113182	194	10-806290	REC10-806290	307-308	1347-6493A1	REC804626R02	132
8245191	REC8245191	265-273	10-806327	REC10-806327	275-279-281-283	1347-7361A1	REC1347-9661A3	132
8283582	REC8M0082988	146	10-806327	REC10-806327	293-298	1347-7362A1	REC1347-816373A4	134
8503991	REC46-8M0113734	185	10-807204	RM10-807204	152	1347-7363A1	REC804626R02	132
8504541	REC46-8M0113735	185	10-812509184	MPO180-001	152	1347-7364A1	REC1347-9661A3	132
8504851	REC3854311	169	10-816601	REC10-816601	269-271-283	1347-7366A	REC804626R02	132
8507522	REC8507522	302	10-816928	REC10-816928	273-223	1347-804623R1/02	REC3304-9354A2	132
8623405	REC86234A4	124	10-824941	RM10-25299	219-221-225-235	1347-804624R02	REC1347-816373A4	134
8733261	REC13037	157	10-85486	REC10-85486	306-307-308	1347-804626R1	REC804626R02	132
8818793	REC8M6000623	148	10-861788	REC10-861788	151-152	1347-816373A4	REC1347-816373A4	134
14358001	REC32-14358001	231	10-865321	REC313715	283	1347-818619R02	REC1347-818619R02	133
44348001	REC32-44348001	231	10-865982005	REC10-865982005	227-237-239	1347-8186191	REC1347-818619R02	133
80176320	SED3093301	247	10-86801	REC10-86801	293-298	1347-8186211	REC1348-818621R02	132
81637002	REC3854003	162	10-90926	REC10-90926	174	1347-8186221	REC1376-818622R02	133
82671013	REC11-862903	305	10-96411	REC10-96411	265	1347-8186221	REC1376-818622R02	133
801331174	RM21325765	143	10-97934	REC10-97934	304	1347-8288A1	REC804626R02	132
801763272	RM21325765	143	10-97934A1	REC10-97934A1	292-304	1347-8291A3	REC804626R02	132
802630001	REC802630T01	129	10-98794	REC10-98794	229-233-259-269-271	1347-8292A4	REC1347-816373A4	134
803623001	REC803623001	160	11-13436	REC11-13436	261-265	1347-8296A4	REC1347-9661A3	132
811637001	REC3854003	162	11-134371	REC11-134371	293-298	1347-9415T	REC1347-816373A4	134
811637001	REC3854003	173	11-134391	REC11-134391	295	1347-9661A3	REC1347-9661A3	132
815504272	GS38320	231	11-22339	REC11-22339	259-269-271-277	1347-9662A4	REC1347-816373A4	134
854179001	SHEP1016	186	11-34933	REC11-34933	291-296	1347-9666A4	REC1347-9661A3	132
861526001	REC821526001	273	11-35921	REC11-35921	263-267-275	1347-9415T	REC1347-816373A4	134
864297001	REC864297T01	146	11-46335	REC11-46335	240-241	1347-9661A3	REC1347-9661A3	132
879150150	REC879150150	144	11-49910	RM11-49910	292	1347-9662A4	REC1347-816373A4	134
879172105	REC3843100	147	11-52707Q1	REC11-52707Q1	263-267-275-279	1348-818621R02	REC1348-818621R02	132
879172259	REC879172259	152	11-8267089	REC11-8267089	261-265-296	1351-4263A1	REC1347-818619R02	133
879194185	REC879194185	184	11-827614	REC90301-ZW1-003	263-267-275-279	1351-4263A2/A3	REC1347-818619R02	133
879194215	REC8M0093561	181	11-859116	REC11-34933	259-263-267-283-297-306-308	1351-5202A1	REC1347-818619R02	133
879194217	TEN01320T	287	11-859124	REC11-859124	263-267	1351-6065A2	REC1347-818619R02	133
879194231	REC8M0093561	181	11-859135	REC11-859135	271	1351-7354A1	REC1347-818619R02	133
879194233	REC8M0093561	181	11-862902	REC11-862902	219-221	1351-8480A2	REC1348-818621R02	132
879194241	REC016940	121				13524A1	REC13524A1	169
879194363	REC21124849	146						
879194371	REC879194371	152						
879312023	SHEP1016	186						

OEM	REF	PAG.	OEM	REF	PAG.	OEM	REF	PAG.
13524A4	REC13524A6	169	16-97520	REC16-97520	235	22-866725	REC22-866725	221-224-229-233-235-237-239-241-241
13524A5	REC13524A1	169	1623-5356A4	REC1623-5356A4	256-261	22-88847A1	REC22-88847A1	291-296
13524A6	REC13524A6	169	1623-815822A30	REC1623-815822A30	257-273	22-89771Q2	GS31066	112
13524Q06	REC13524A6	169-174	1623-815822A32	REC1623-815822A53	257	22-8M0058389	REC22-67892A05	283
13524T1	REC13524A1	169-174	1623-815822A43	REC1623-815822A53	257	22-98477A2	REC22-98477A2	179
13753A2	REC815407A2	168	1623-815822A45	REC1623-815822A55	257	23-29804T	REC23-29804T	261-265
1376-5659A1	REC1376-818622R02	133	1623-815822A47	REC1623-815822A47	257	23-30617A2	REC23-30617A2	261-265
1376-5744A1	REC1376-818622R02	133	1623-815822A53	REC1623-815822A53	257	23-32632	REC23-32632	259
1376-6152A1	REC1376-818622R02	133	1623-815822A6	REC1623-815822A30	257	23-67370	REC23-67370	273
1376-818622R02	REC1376-818622R02	133	1623-815823A5	REC1623-815822A53	257	23-805041A2	REC23-805041A2	295-303
1389-9562A1	REC3310-860070A2	135	1623-8951A33	REC1623-8951A33	256	23-806036A1	REC23-806036A1	295-303
1389-9670A2	REC3310-807312A1	133	1623-8951A37	REC1623-8951A37	256-265	23-806922	REC23-806922	178-180
1396-4148	REC1396-4148	142	1623-8951A43	REC1623-8951A43	256	23-807073	REC23-807073	308
1396-4656	REC1396-4656	138	16457A4	REC805759Q01	168	23-815921A17	RM23-815921A17	272-273
1396-5222	REC1396-5238	139	1656-8866A55	REC1656-8866A55	255	23-815921A21	REC23-815921A21	273
1396-5238	REC1396-5238	139	1656-8866A63	REC1656-8866A63	255	23-8159501	REC23-8159501	307
1397-2060	REC1397-2060	136-139-140-141	1656-8M0046682	REC1656-8M0046682	255	23-816583	REC23-816583	257-273
1397-2067	REC823427A1	137	1656-8M0046733	REC1656-8M0046733	255	23-816599	RM23-816599	291
1397-2150	REC1397-2150	113	1656-8M0046735	REC1656-8M0046735	255	23-824108	REC23-824108	267-275
1397-2634	REC823427A1	137	1656-8M0046738	REC1656-8M0046738	255	23-847637	REC23-847637	293-298
1397-3327	REC1397-3327	136	16755Q1	REC16755Q1	276-277-197-199	23-847638	RM23-847638	298
1397-3459	REC823427A1	137	16755Q1	REC86310	277	23-853853002	REC23-853853002	217
1397-5830	REC1397-8760	137	16792A39	REC16792A39	292	23-853855001	REC23-853855001	217
1397-5831	REC1397-5831	139-141	17-14872A1	REC17-14872A1	141-306	23-861209A1	REC23-861209A1	277-297-303
1397-5837	REC3302-9031	136	17-14872A1	REC21380	306	23-87560091	RM23-87560091	277
1397-6367A1	REC1397-6367A1	138	17-14873A1	REC17-14873A1	306	23-87560094	RM23-87560094	277
1397-7099	REC1397-8760	137	17-14873A1	REC21370	306	23-87560097	RM23-87560097	277
1397-7542	REC823427A1	137	17-35973	REC331880	267	23-89574	REC23-89574	305
1397-7547	REC823427A1	137	17-44166	REC17-44166	308	23-90915	REC23-90915	174
1397-8545	REC1397-8767Q	112	17-44166T1	REC14-44166T1	308	23-92916	REC23-8M8000506	279-283
1397-8546	REC1397-3327	136	17-44167A1	REC17-44167A1	308	23-98356	RM23-98356	291-296
1397-8582	REC1397-8582	142	17-47617	REC17-47617	174	23-983571	RM23-983571	291-296
1397-8760	REC1397-8760	137	17-815953A01	REC17-815953A01	307	23-99291T	REC23-99291T	306
1397-8767	REC1397-8767Q	112	17-8M0073409	REC17-8M0073409	296	23-99299	REC23-99299	304
1397-8767Q	REC1397-8767Q	112	17177A1	REC17177A1	175	23-99322	REC23-99322	292-304
1397-8872	REC823427A1	137	17494A1	REC17494A1	180	23-99352	RM23-99352	293-298
1397-8873	REC823427A1	137	17649T	REC891736T	156	24-17997A1	REC24-17997A1	269-271-277
1397-8959	REC1397-3327	136	18-32665	REC18-32665	259-295	24-30893	REC24-30893	267-275
1398-3089	REC1398-3089	138	18525A1	REC18525A1	156	24-30893	REC31-30893T	263
14-18323	REC14-18323	267-275-279-281	18643A7	REC18643A7	304	24-803192A2	REC27-803192A2	187
14-79447	REC14-79447	263	18654A1	CEF500512K	300	24-8M0094247	REC27-8M0094247	143
14-816629Q	REC90508-ZW1-003	267-275-279	18654A1	REC18654A1	295-297-300	25-16524	REC25-16524	215
14-86739	RM86739	279-281	18920A1	REC18920A1	295-297	25-20081	REC25-20081	215
14034A3	REC14034A3	306	19-14842	REC19-14842	306-308	25-20415	REC25-16524	215
14035A3	REC14035A3	306	19-42682	REC19-42682	259	25-20826	REC308627	215-279-281-283
14336A20	REC865380A13	155	19-47579	REC19-47579	259	25-20863	REC25-20863	215
14336A8	REC865380A13	155	19-59504	REC19-59504	192	25-21836	REC25-21836	215-273
14336A9	REC865380A25	155	19-815951	REC19-815951	307	25-25439	REC25-25439	215-259-261-265-269-271
14348A1	REC807166A3	253	19-864689	REC19-864689	229-233	25-26543	REC333572	215
14478T	BAMC-20-14478	249	19405A4	REC13524A6	169	25-26722	REC302588	215
14478T01	BAMC-20-14478	227-230-237-239-249	19742A1	RM806193A48	185	25-26802	REC25-8M0084884	183
14505A2	REC14505A2	304	19742A3	RM806193A48	185	25-26802	REC303347	215
14587A5	REC14587A7	267-275	21-20553	REC13-35048	219-221-222	25-26855	REC3852928	215
14801A1	RM14801A1	233-237-249	22-328022	REC22-328022	221-227-237-239-240-241-249	25-29439	REC309731	215
15-32563A1	REC15-32563A1	259-269-271	22-32803	REC22-32803	222-224-249	25-29845	REC25-29845	277
15-35980A1	REC15-35980A1	259-269-271	22-36382	REC22-36382	219-221-227-237-239-249	25-30224Q	REC25-30224	180
15-36178A02	REC15-36178A02	269-271	22-384071	REC22-384071	237	25-30271	REC25-30271	261-265
15-36178A02	REC15-36178A02	259	22-41622	REC22-41622	221-227-235-237-239-240-249	25-30529	REC25-30529	215
15-42637A1	REC15-42637A1	265-273	22-428611	REC22-428611	224-227-229-233-237-239-259-296	25-30613	REC25-30613	215-261-265
15-44491A1	REC15-44491A1	275	22-43828T	RM22-43828	296	25-31305	REC553126	215
15-45691A1	REC15-45691A1	259-269	22-49718	RM22-49718	305	25-31534	REC25-31534	263-267-275-279-281
15-47397A1	REC15-47397A1	263-267-275	22-67892	REC22-67892A05	281	25-31986	REC3852866	215
15-57007A1	REC15-57007A1	261	22-73379	REC22-73379	227	25-32509	REC304174	215
15-71013	REC15-71013	259-269-271	22-73379	REC22-73379	227	25-32546	REC25-32546	215-259-269-271
15-86749A1	REC15-86749A1	279-281-283	22-806608A1	REC13980	229-233-237-239-291	25-33145	REC25-33145	215-261
15-92914A1	REC15-92914A1	279-281	22-860382	REC22-860382	295	25-33465	REC25-33465	192-215-279-283
1547-815930A7	REC1547-815930A7	257-269-271	22-861150A1	REC22-861150T02	185-295-297	25-33466	REC302537	215
1547-861063A10	REC1547-861063A10	257	22-861150A2	REC22-861150T02	185	25-33504	REC0307239	215-295
1547-861063A12	REC1547-861063A12	257	22-861150T02	REC22-861150T02	185	25-33756	REC305123	215
1547-861063A6	REC1547-861063A6	257	22-861163	RM22-861163	185-295-297	25-35027	REC25-35027	269-271-277
1547-861063A8	REC1547-861063A8	257	22-862210A01	REC862210A01	227	25-35029	REC25-35029	215
1547-9412A20	REC1547-9412A20	256	22-862210A01	REC862210A01	229	25-35276	REC310584	215
1547-9412A21	REC1547-9412A21	256	22-862210A01	REC862210A01	230	25-35480	REC321921	215
1547-9412A22	REC1547-9412A22	256	22-862210A01	REC862210A01	230	25-36318	REC25-36318	273
1547-9412A23	REC1547-9412A23	256	22-862210A01	REC862210A01	237	25-36318	REC301967	215
1589-865440H50	REC1589-865440H50	255	22-862210A01	REC862210A01	239	25-38099	REC25-38099	215-265
1589-865440H51	REC1589-865440H51	255	22-862210A01	REC862210A01	239	25-38101	REC25-38101	215
1589-865440H52	REC1589-865440H52	255	22-862210A01	REC862210A01	239	25-38933	REC25-38933	215
16-49545	REC16-49545	219-225-227-235-237-239-240-241	22-865417	REC22-865417	295-297	25-39695	REC326849	215
16-56826	REC16-56826	221				25-457101	REC25-457101	215-277
16-59579	REC16-59579	295-297						
16-70236	REC16-70236	219-221						
16-806300	REC16-806300	222						

OEM	REF	PAG.	OEM	REF	PAG.	OEM	REF	PAG.
25-45711	REC326649	215	26-805080	REC26-861694	216	27-68715	REC27-68715	217-224-252
25-47254	REC310414	215	26-805344	REC26-805344	279-281-283	27-70142	REC27-70142	137-139
25-48171	REC25-48171	215-295-297	26-807006	REC26-807006	216-277	27-70143	REC27-8079821	137
25-48452	REC302035	215	26-811554	REC26-811554	216	27-701431	REC27-8079821	137
25-54029	REC25-33465	215	26-814622	FELBS40013	216-217	27-70905	REC27-70905	217
25-55682	REC26-55682	216	26-816464-1	REC26-8164641	273	27-72479A5	REC27-72479A5	217
25-55801	REC25-55801	215-259	26-8164641	REC26-8164641	216-261-265	27-72805	REC27-72805	125
25-58390	REC909140	215	26-816575A2	REC26-816575A2	273	27-73666	REC27-73666	217
25-62700	REC25-62700	215	26-816575A3	REC26-816575A3	272-273-278	27-73866	FEL17460	253
25-62704	REC3852045	215	26-821092	REC26-821092	216	27-73866	REC3852455	241
25-62705	REC25-62705	215-277-295-297	26-8219471	REC26-8219471	216-217	27-73866	REC3852455	253
25-62706	REC25-62706	277	26-823894	REC26-823894	216-259-269-271	27-74830	REC27-74830	180
25-62707	REC25-62706	215	26-861694	REC26-861694	283	27-801333454	REC27-8M0094247	143
25-64068	REC333572	215	26-864319	REC26-864319	271-273	27-8052151	REC27-8052151	192
25-65936	REC331188	215	26-88397	REC26-88397	269-271	27-805396	REC27-805396	137
25-67202	REC25-67202	215	26-88397A1	REC26-88397A1	269-271	27-805760	REC27-805760	174
25-67202	REC313175	215	26-88416	REC26-88416	291-296	27-807218	REC27-807218	219-221-225-250
25-70937	REC25-70937	215-259-269-271	26-892361	REC26-24590	216	27-807982	REC27-8079821	137
25-805331	REC3852865	215	26-89238	REC26-89238	216-261-265	27-8079821	REC27-8079821	137-221-222
25-805331	REC3852865	283	26-892683	REC26-892683	129	27-8146801	REC27-8146801	180
25-8071341	REC25-8M0084884	183	26-8M0033407	REC26-8M0033407	283	27-815528	REC27-815528	222-252
25-822370	REC25-33465	279-281	26-8M0050563	REC70817B	216	27-8172771	REC27-8172771	273
25-823683	REC25-823683	215	26-8M0150312	REC26-8M0150312	216	27-818832	REC27-863726	251
25-87400A2	REC25-87400A2	307-308	26-90562	REC26-90562	192-216	27-85046	REC27-850456	215
25-89497	REC25-89497	215	26-90925	REC26-90925	216-217	27-854129	REC27-8M0094247	143
25-89633	REC32126	183	26-94038	REC26-94038	216	27-856081	REC27-856081	261-265
25-896332077	REC32077	184	26-96063	REC26-897153	216	27-856704	REC27-856704	261
25-896332126	REC32126	183	26-965031	REC26-965031	216-259	27-856705	REC27-856705	224-251
25-8M0039163	REC25-8M0084884	183	26-97664	REC70817B	216	27-858524	REC27-858524	261-265
25-90011	REC25-90011	215-265-273	26-976641	REC70817B	216	27-860232	REC27-863726	251
25-94288	REC25-94288	192	27-13709	REC27-13709	217	27-860233	REC27-863724Q	251
25-97387	REC25-97387	215-277	27-14250	REC27-14250	215	27-863724	REC27-863724Q	251
256611T1	REC378444	157	27-18272	REC27-18272	224-251	27-863724Q	REC27-863724Q	227-237-239-251
26-12224	REC26-12224	216-263-267-275	27-33179Q02	REC27-33179Q02	180	27-8637251	REC27-8637251	227-237-239-251
26-12709	REC26-12709	216	27-33395	FEL17420	233-235-237-253	27-863726	REC27-863726	251
26-127091	REC26-12709	277	27-33395	REC27-33395	233-235-237-249-253	27-863726	REC27-863726	227-237-239-251
26-14077	REC26-76868	216-275	27-33956	REC27-33956	187	27-863726	REC27-863726	227-237-239-251
26-14240	REC26-14240	216-217	27-34213	REC27-34213	124-125	27-864547A02	REC27-864547A02	252
26-14756	REC26-14756	213-214-216	27-34486-3	REC27-344861	174	27-864547A02	REC270	233-251
26-16709A2	REC26-16709A2	276-277	27-34897	REC27-34897	187	27-864549A02	REC270	251
26-16977	REC26-16977	216-261-265	27-34898	REC27-34898	125	27-864549A02	RM27-864549A02	252
26-20070	REC908855	216	27-35898T	REC27-35898T	218	27-864550A02	REC270	251
26-24590	REC26-24590	216	27-39915	REC27-39915	218-251	27-864850A02	REC27-864850A02	252
26-26226	REC310599	216	27-39917	REC27-39917	218-250	27-871051	REC27-863726	251
26-30913	REC26-30913	216	27-39923	BAMC47-27-39923	218-250	27-89656-1	REC27-89656-1	181
26-31249	REC26-24590	216	27-40431	REC27-40431	241	27-896561	REC27-89656-1	224
26-32511	REC26-32511	216-259	27-41609	REC27-41609	137-140	27-898101475	REC27-8M0094247	143
26-32511A1	REC26-32511A1	258-259	27-41812	REC27-41812Q	181	27-8M2021920	REC27-33918	181
26-32911	REC26-32911	216	27-418122	REC27-418122	181	27-94914	REC27-94914	192
26-33144A2	REC26-33144A2	261-265	27-41812Q	REC27-41812Q	181	27-94996Q2	REC27-94996Q2	269-271-295-299
26-33467	REC26-33467	216	27-41813	REC27-863724Q	251	27-96429	REC27-96429	221-253
26-34217	REC26-34217	216	27-42457	REC27-42457	125	27-97542	REC27-856705	251
26-36556	REC26-36556	279-281	27-42631-1	REC27-426311	265	27-988231	REC27-988231	291-296
26-36557	REC26-36557	259	27-430331	REC27-430331	273	27-995061	REC27-995061	291
26-38970	REC26-38970	261-265	27-46401	FEL17319	225-252	27-99757	REC27-99757	227-229-230-252
26-416071	REC26-8M2005029	291-296	27-46820	REC27-46820	239-240-253	27-99771	REC27-99771Q02	251
26-41953	REC26-419533	216	27-47510Q	REC27-47510Q	180	27-99772	REC27-99772Q02	251
26-43035	REC26-43035	216	27-47590-1	REC27-475901	181	27-99777Q02	REC27-99777Q02	219-221-222-225-235-241-251
26-43036	REC26-43036	216	27-47644-1	REC27-47644-1	290-291			
26-43993	REC26-43993	216-277	27-48042	REC27-48042	240-251			
26-45577 1	REC26-455771	216-263-267-273-279-281-283	27-480431	REC27-480431	219-225-235-240-250	27-99960	REC27-99960	251
26-45587	REC26-45587	216	27-48399	REC27-48399	137-141	28-30281	REC28-30281	263-267
26-54925	REC26-54925	291	27-48818Q01	REC27-48818Q01	181	28-8M0032833	REC28-8M0032833	273
26-55682	REC26-55682	216-291	27-49110	REC27-49110	187	28-8M0032834	REC8M0032834	261
26-56397	REC26-56397	216	27-49953	REC27-49953	215	30-72961	REC30-72961	192
26-56788	REC26-56788	216	27-524572	REC27-524572	137-139-140-141-142	30-879194A01	REC30-879194A01	291
26-62818	REC26-62818	216	27-52546	REC27-52546	218-252	30-879194A01	REC30-879194A01	296
26-64818Q4	REC27-64818Q4	259	27-53045Q01	REC27-53045Q01	181	30-88957T	REC30-88957T	263-267
26-66302	REC26-66302	216-269-271-273	27-53354	REC27-53354	219-252	30-88957T1	REC30-88957T1	275
26-67388	REC26-67388	216-217	27-54014Q1	REC27-54014Q1	108-299	30-98475T1	REC30-98475T1	179
26-69188	REC26-69188	216	27-5450	REC27-54506	181	300-8M0044991	REC300-8M0044991	161
26-69189	REC26-69189	216	27-54529	REC27-54529	215	31-15842	REC31-15842	275
26-70081	REC26-70081	216	27-55810 1	REC27-558101	259	31-15844	REC31-15844	275
26-72785	REC26-72785	192-216	27-56108	REC27-56108	215	31-30894A1	REC31-30894A1	275
26-75413	REC26-75624	216	27-56880	REC27-56880	187	31-30894A5	RM31-30894A5	271
26-75624	REC26-75624	216-217	27-60208	REC27-60208Q	181	31-30895T	REC31-30895T	263-267-275
26-75980	FEL17740	216-217	27-60715	REC27-60715	137	31-30956T	REC387247	263-267-275
26-75988	REC26-75988	216	27-64692	REC27-64692	137-219-221	31-32573A1	REC31-32573A1	259-271
26-76868	REC26-76868	216-263-267-279-281	27-64718A1	REC27-64718A1	259	31-32575T1	REC31-32575T1	259-269-271
26-76868A04	REC26-76868A04	279-281-283	27-64818Q4	REC27-64818Q4	295-299	31-33138A1	REC31-33138A1	273
26-79831	REC26-79831	216	27-65577	REC27-65577	137	31-35928T1	REC31-35928T1	263-267-275
26-804507	REC26-8M0150312	216	27-684547A02	REC270	229	31-35988A12	REC31-35988A12	259-269
			27-68714	REC27-68714A6	201-203-215	31-35990A1	REC31-35990A1	259-269-271
						31-36387A1	REC31-36387A1	265-273

OEM	REF	PAG.	OEM	REF	PAG.	OEM	REF	PAG.
31-42647A1	REC387817	267-275	32-864959	REC32-864959	306-307-309	35-808275	REC35-808275	116
31-53079A1	REC31-53079A1	261	32-864960	REC32-864960	306-307-309	35-809097	LENS3213	111
31-54042T	REC31-54042T	279-281	32-87117	REC32-871171	200	35-809097	RACS3213	111
31-61100A1	REC31-61100A1	259-269	32-871171	REC32-871171	200	35-809099	RACS3214	111
31-66668A1	REC31-66668A1	281	32-87234	REC32-87234	309	35-815419	REC016940	121
31-66818A1	REC31-66818A1	259	32-87235	REC32-87235	309	35-816168	REC35-816168	122
31-814653	REC31-814653T	275	32-88795	REC32-88795	199	35-850481	REC500MA	119
31-815900	REC31-815900	277	32-887952	REC32-887952	199-201-202	35-850481A1	REC500MA	119
31-828437A2	REC31-828437A2	267-275	32-89653	REC32-89653	198	35-863829	RM35-863829	113
31-828439A2	REC31-828439A2	275	32-897181	REC32-897181	199-202-203	35-864572	REC864572	112
31-86748A1	REC31-86748A1	279-281-283	32-897301	REC32-897491	200-202-203	35-866171A01	REC35-866171A01	112
31-86752A1	REC31-86752A1	279-281-283	32-89749-1	REC32-897491	200-202-203	35-866340Q03	REC35-06003	104-105-106-107-114
31-86754T	REC31-86754T	279-281	32-8M0062102	REC8M0062102	198	35-866340Q03	RM35-866340Q02	114
31-86763A04	RM31-86763A04	277	32-8M0062102	REC8M0062102	296	35-866594K01	RM35-866594Q01	110
31-86763A2	REC31-86763A2	277	32-8M0062309	REC32-4172533	198	35-866594Q01	RM35-866594Q01	110
31-86771	REC31-86771	277	32-8M0062614	REC32-33220	200	35-879172104	REC35-879172104	107-116
31-87156	REC31-87156	277	32-90949T	CEF500511K	253	35-879172143	REC35-879172143	107-120
31-92366A1	REC31-92366A1	263			221-224-227-237-239-253	35-879312041	REC35-879312041	107-121
31-99328A1	REC31-66668A1	279-283	32-90949T	REC32-90949T		35-881132T	REC35-8M0138697	114
31640A4	CM31640	288	32-95858	REC32-861127	309	35-883702Q	REC35-06004	104-105-114
31640A4	CM31640A	288	32-95859	REC32-861129	309	35-883702Q	RM35-883702Q	114
31640Q4	CM31640	263-267	32-96246A4	REC32-96246A4	199-201-202	35-884380T	RAC31871	112
31640Q4	CM31640A	263-267	32-99902	REC32-864589	309	35-884380T	REC35-8M0122423	112
31640Q4	REC31640Q4	285	32-99902-1	REC32-864580	309	35-886638	LENS3227	111
31640Q4	REC31640Q4AL	285	32-99903	REC32-864586	309	35-886638	RACS3227	111
32-14358	CEF500508K	253	32-99903-1	REC32-864959	309	35-892665	REC35-892665	105-106-107-113
32-14358	REC32-14358001	253	32-99904	REC32-99904	309	35-892665	REC35-892665	105-106-107-113
32-14358001	CEF500508K	253	32-99904Q	REC32-99904	306-307-308	35-898272048	REC35-898272048	120
32-14358001	REC32-14358001	227-220-230-233-237-239-253	32193A2	REC1463-9382	162	35-8M0020349	RAC31871	112
32-14358T	CEF500508K	253	32734A3	CEF500512K	300	35-8M0020349	REC35-8M0122423	112
32-14358T	REC32-14358001	253	32734A3	REC18654A1	300	35-8M0046752	REC35-8M0046752	112
32-16012	REC32-16012	199	33-55816	REC32-55816	305	35-8M00600041	RAC31871	112
32-160211	REC32-160211	200-201-202	3302-804689	REC3302-804689	136-140-141	35-8M00600041	REC35-8M0122423	112
32-32461	REC32-32461	198-291-295	3302-804845	REC3302-804845002	139-140-141-171	35-8M0066483	REC35-8M0066483	107-121
32-32461A1	REC32-32461	198-108	3302-804845	REC3302-804845	138	35-8M0067337	REC35-8M0067337	107-116
32-33189	REC32-33189	199-201-202-203	3302-9031	REC3302-9031	136	35-8M0067597	REC6S01030	120
32-33220	REC32-33220	200	3302-9033	REC35-53336	113	35-8M0103963	REC35-19486	116
32-3322070	REC32-33220	200	3302-9407	REC3302-9407	136-140-141	35-8M0116378	REC35-06007	114
32-4172533	REC32-4172533	198-291-295	3302-9437	REC3302-804845	138	35-8M0138697	REC35-8M0138697	114
32-43437	REC32-43437	198-296	3304-9354A2	REC3304-9354A2	132	35-8M0150917	REC882687	122
32-44348	CEF500507K	253	3310-804624R1	REC1347-816373A4	134	35-8M2001030	RM35-8M2001030	113
32-44348	REC32-44348001	253	3310-806077A2	REC3310-860070A2	135	35-8M6002131	REC35-8M6002131	107-120
32-44348	REC32-44348001	253	3310-806078A2	REC3310-860070A2	135	35-8M6002390	REC35-8M6002390	116
32-44348001	CEF500507K	253	3310-807312A1	REC3310-807312A1	133	35-93568	REC93568	113
32-44348001	REC32-44348001	221-222-227-229-230-233-237-239-253	3310-807312R02	REC3310-807312A1	133	36-97335	REC3853341	216
32-44348T	CEF500507K	253	3310-815396A2	REC3310-860070A2	135	36223A1	CEF500522K	299
32-44348T	REC32-44348001	223-253	3310-861245A1	REC3310-860070A2	135	36223A2	REC36223A2	299
32-48132	REC32-48132	201-202-203	3310-861448A1	REC3310-864943A01	134	36223A2	CEF500522K	299
32-52481	REC32-52481	198-200-201	3310-864941A01	REC3310-864942A01	134	36223A2	REC36223A2	299
32-54236	REC32-54236	259	3310-864942A01	REC3310-864941A01	135	39-74381A1	REC39-74381A1	217
32-55816	REC32-55816	309	3310-864943A01	REC3310-864942A01	135	391-5075	REC982209	168
32-58432A2	REC32-58432A2	305-309	3310-9350A2	REC3310-864943A01	134	391-5075Q1	REC982209	168
32-59841	REC32-59841	305-309	33662Q	REC3310-860070A2	135	391-5088	REC89825302	169
32-59842	REC32-59842	305-309	33765T	REC33662	170	391-5090	REC391-5090	170
32-805375	RM32-805375	199-202	33863T	REC33765T	168	391-5090A1	REC391-5090Q1	170
32-806209-1	RM32-806209-1	199	34127T2	MP514693	193	391-5090Q1	REC391-5090Q1	170
32-8066351	REC32-8066351	200-201-202-203	34127T2	CM34127	288	391-5092	REC8M6001217	170
32-8066361	REC32-8066361	200-201-202-203	34235A1	CM34127A	288	391-5093	REC8M6001217	170
32-806856	REC32-806856	199-201-202-203	34235Q1	REC3423A1	170	391-7057	REC89825302	169
32-807407	REC32-807407	199	34235T	REC3423A1	170	391-898253004	REC8M6001217	170
32-807458T	CEF500532K	253	34762A1	REC34235T	170	392-6316	REC392-6316	176
32-807458T	REC32-807458T	253	34765A2	CM34762	288	392-6318	REC835702	168
32-807661	REC32-807661	199-201-202	35-11004A1	CM34762A	288	392-6318T	REC835702	168
32-807697	REC32-807697	200-201-202-203	35-16595Q	REC34765A2	254	392-6324	REC8M6001249	170
32-808033	REC32-808033	199	35-16595Q	REC35-8M0046752	112	392-6324A1	REC392-6324Q1	171
32-808044-1	REC32-8080441	199	35-16595T1	REC3850559	114	392-6324Q1	REC392-6324Q1	171
32-8600891	REC32-8600891	199-203	35-19485	REC3850559	121	392-6324T1	REC392-6324Q1	171
32-860144	RM32-860144	200-201	35-19487	REC127695-35150	121	392-6325	REC8M6001219	170
32-860205	REC32-860205	199-201-203	35-49088A2	REC35-19486	116	392-6325A1	REC392-6325Q1	171
32-860220	REC32-860220	269-271	35-49088Q2	REC35-19487	120	392-6325Q1	REC392-6325Q1	171
32-860331	RM32-860331	200	35-52731	REC35-49088A2	113	392-6325T1	REC392-6325Q1	171
32-86036	REC32-86036	305-309	35-53336	REC35-49088A2	113	392-6326	REC834975	169
32-86036Q	REC32-86036	309	35-53336Q	REC3850559	121	392-6326T	REC834975	169
32-861057	RM32-861057	200	35-802886Q	REC35-53336	113	392-6330	REC392-6330	176
32-861127	REC32-861127	306-307-308-309	35-803470	REC35-53336	113	392-7803A4	REC300-00879	161
32-861128	REC32-861128	306-307-308-309	35-803897Q1	REC35-06007	114	392-805570A2	REC300-00879	161-174
32-862124	REC32-862124	200	35-80470Q	REC3517857	121	392-806529A1	REC1463-9382	162
32-862139	REC32-862139	200	35-805312	REC3517857	121	392-863704T	REC3861985	161
32-864588	REC32-864588	306-308-309	35-805809	REC35-8M0046752	112	392-881732	REC3861267	161
32-864589	REC32-864589	306-308-309	35-807256T	REC3517857	121	392-889925	REC3861267	161
				REC35-805312	120	392-898223002	REC3859078	161
				REC35-805809	121	392-898253005	REC8M6001249	170
				REC35-805809T	121	392-898253005	REC8M6001219	170
				REC35-807256	116	392-8M0054588	REC3861985	175
						392-9086	REC392-9086T	168

OEM	REF	PAG.	OEM	REF	PAG.	OEM	REF	PAG.
392-9086T	REC392-9086T	168	46-64141A11	REC46-64141A11	189-260-261	48-16315A46	SOL1532-143-17	316
392-9089	REC3853801	169	46-72774A11	REC46-72774A32	187	48-16315A46	SOL1552-148-16	316
392-9089Q	REC3853801	169	46-72774A32	REC46-72774A32	187	48-16316A46	SOL1531-140-19	316
392-9089T	REC3853801	169	46-72774A69	RM46-807151A8	185	48-16316A46	SOL1551-148-18	316
392-9766	REC392-9766	168	46-73823A7	REC46-72774A32	187	48-16317A46	SOL1532-140-19	316
392-9766Q1	REC392-9766	168	46-807151A12	REC46-72774A32	187	48-16317A46	SOL1552-148-18	316
392-9766T	REC392-9766	168	46-807151A14	REC46-807151A14	192	48-16318A46	SOL1531-140-21	316
392-9767	REC3853801	169	46-807151A8	RM46-807151A8	185	48-16318A46	SOL1551-148-20	316
393-3230	REC3854331	168	46-807151A9	REC46-807151A9	186	48-16319A46	SOL1532-140-21	316
393-3230	REC393-4988	168	46-862914T10	REC46-862914T10	187	48-16319A46	SOL1552-148-20	316
393-4988	REC393-4988	168	46-879194401	REC879194401	185	48-16320A46	SOL1531-140-23	316
393-4988T	REC3854331	168	46-96148A5	REC46-96148A8	190	48-16320A46	SOL1551-143-22	316
393-4988T	REC393-4988	168	46-96148A8	REC12120	189-264-265	48-16321A46	SOL1532-140-23	316
393-4988T2	REC3854331	168	46-96148A8	REC46-96148A8	190	48-16321A46	SOL1552-143-22	316
393-4988T2	REC393-4988	168	46-96148T1	REC46-96148T1	261-265	48-16322A46	SOL1531-140-25	316
393-9459Q1	REC3854331	168	46020T02	REC46020T02	259-269	48-16322A46	SOL1551-140-24	316
41141A2	REC862077A1	124	46399A1	CM46399	288	48-16543A46	SOL1552-148-19	316
414336A6	REC865380A25	155	46399A1	CM46399A	288	48-16544A46	SOL1551-148-19	316
41629A2	RM45-41629A2	279	47-43026Q02	CEF500301	188	48-16545A46	SOL1552-145-21	316
41641A8	REC41641A8	279	47-43026Q02	REC47-43026Q02	109-188-273	48-16546A46	SOL1551-145-21	316
41641A8	REC41641A8	281	47-43026Q06	REC47-43026Q06	108-190	48-16547A46	SOL1552-143-22	316
41646A9	RM41646A9	297	47-59362A4	REC47-59362A4	187-191	48-16548A46	SOL1551-143-22	316
41674T	REC41674T	296	47-59362Q01	CEF500109	188	48-16549A46	SOL1552-140-24	316
41674T	REC41674T	297	47-59362Q01	REC47-59362Q01	188-192	48-16550A46	SOL1551-140-24	316
42260A6	RM42260A6	291	47-59362Q08	REC47-59362Q08	191	48-18278A46	SOL1511-155-17	316
42419A1	REC42419A1	156	47-59362T5	REC47-59362T5	191	48-18278A46	SOL1571-155-17	316
42600A09	REC42600A09	159	47-59362T6	REC47-59362T6	191	48-18610A40	SOL1611-193-15	316
42600A1	REC42600A09	159	47-801332602	CEF500106GT	188	48-18610A40	SOL1641-193-15	316
42600A3	REC42600A09	159	47-801332602	JOH09-1028B	188	48-18610A6	SOL1611-193-15	316
42600A5	REC42600A09	159	47-801332602	REC3841697	188	48-18610A6	SOL1641-193-15	316
42724A3	REC42724A3	259	47-808145T	SHE15979	186-191	48-18611A40	SOL1612-193-15	316
42815A6	RM42815A6	295	47-809866T	CEF500161	188	48-18611A40	SOL1642-193-15	316
43-14063A1	RM43-14063A1	279-281	47-809866T	REC47-809866T	188	48-18611A6	SOL1612-193-15	316
43-18411A2	REC43-18411A2	259-269	47-816814T	CEF500177GT	188	48-18611A6	SOL1642-193-15	316
43-18411A4	REC43-18411A2	259-268-269	47-816814T	JAB17018-0001	107-188	48-18612A40	SOL1611-188-17	316
43-45814A5	REC43-45814A5	259-269	47-816814T	REC3593573	188	48-18612A40	SOL1641-188-17	316
43-55778A3	REC43-55778A3	259-269	47-831311350	CEF500161	188	48-18612A6	SOL1611-188-17	316
43-66773A3	RM43-66773A3	259	47-831311350	REC47-809866T	188	48-18612A6	SOL1641-188-17	316
43-75325A3	REC43-75325A3	259-269	47-853126	CEF500167	188	48-18613A40	SOL1612-188-17	316
43-818807	REC43-818807	174	47-853126	SHE15000K	188	48-18613A40	SOL1642-188-17	316
43-828073A1	REC43-828073A1	267-275	47-853126	SHE15000K	188	48-18613A6	SOL1612-188-17	316
43-853592A2	REC43-878617A2	275	47-862232A2	CEF500159G	188	48-18613A6	SOL1642-188-17	316
43-853640A2	REC43-853640A2	271	47-862232A2	REC47-862232A2	188	48-18614A40	SOL1611-183-19	316
43-853641A2	REC43-853641A2	271	47-879194186	CEF500114T	188	48-18614A40	SOL1641-183-19	316
43-853642A2	REC43-853642A2	271	47-879194186	JAB17937-0001-P	107-188	48-18614A6	SOL1611-183-19	316
43-853643A2	REC43-853643A2	271	47-879194186	REC17937-0001	188	48-18614A6	SOL1641-183-19	316
43-878087A2	REC43-878087A2	275	47-879312025	CEF500120T	188	48-18615A40	SOL1612-183-19	316
43-887903A1	RM43-887903A1	277	47-879312025	REC10615K	186-188	48-18615A40	SOL1642-183-19	316
43-887906A1	RM43-887906A1	277	47-879312025	SHE10615K	107-188	48-18615A6	SOL1641-183-19	316
43-887909A1	RM43-887909A1	277	47-896332063	CEF500155	188	48-18615A6	SOL1642-183-19	316
43557A1	REC805759Q01	168	47-896332063	JAB11979-0001	107-188	48-18616A40	SOL1611-178-21	316
43881A17	RM43881A17	296	47-896332063	REC11979-0001	188	48-18616A40	SOL1641-178-21	316
43994A2	CM43994	288	47-89984Q5	REC47-89984Q5	190	48-18616A6	SOL1611-178-21	316
43994A2	CM821631	288	47-89984Q5	RECMC00004	190	48-18616A6	SOL1641-178-21	316
43994A2	CM821631A	288	47-89984T4	CEF500313G	188	48-18617A40	SOL1612-178-21	316
44-41630T	RM44-41630T	279-281	47-89984T4	REC47-89984T4	188-261-265	48-18617A40	SOL1642-178-21	316
44-8146061	REC44-8146061	267	47-8M0104229	CEF500159G	188	48-18617A6	SOL1612-178-21	316
44-824110	REC44-824110	263-267-275	47-8M0104229	REC47-862232A2	188	48-18617A6	SOL1642-178-21	316
44-850308	REC44-850308	275	47441A1	REC47441A1	180	48-18618A40	SOL1641-175-23	316
44-850308	RM44-41630T	279	47442A1	REC8M0061068	180	48-18618A6	SOL1641-175-23	316
44-865322T	RM44-865322T	283	47587A2	BAMC29-47587	177	48-18619A40	SOL1642-175-23	316
44181A1	RM44181A1	217	47638A1	BA1-47638	218-250	48-18619A6	SOL1642-175-23	316
44182A1	FEDV-1984	217	47735A1	BAMC1-47735	244	48-18620A40	SOL1641-175-23	316
44182A1	RM44182A1	217	47735A17	BAMC1-47735	240-244	48-18620A6	SOL1641-173-25	316
44266T	RM807130A4	250	47736A17	BAMC1-47736	240-244	48-18621A40	SOL1642-173-25	316
44266T1	RM807130A4	250	47737A1	BAMC1-47737	240-244	48-18621A6	SOL1642-173-25	316
44354A3	MAR988	245	47737A10	BAMC1-47737	244	48-19838A46	SOL1511-158-15	316
44354A3	MAR988	245	47738A1	BAMC1-47738	240-244	48-19841A46	SOL1512-158-15	316
45-41629A2	RM45-41629A2	281	47738A10	BAMC1-47738	244	48-78114A45	SOL1511-160-13	316
45-41939F1	REC45-41939F1	261	47877A4	BAMC20-76668	245	48-78114A45	SOL1531-156-13	316
45-42634	REC45-42634	265	48-13700A46	SOL1511-153-19	316	48-78116A4	SOL1513-148-15	316
45-55796	REC45-55796	259	48-13700A46	SOL1571-153-19	316	48-78116A4	SOL1531-145-15	316
45-55796-1	REC45-557961	269	48-13701A46	SOL1512-153-19	316	48-78126A45	SOL1511-142-23	316
45-557961	REC45-557961	271	48-13701A46	SOL1572-153-19	316	48-78126A45	SOL1531-140-25	316
45-812773	RM45-812773T	277	48-13702A46	SOL1511-153-21	316	48-826072A46	SOL1511-160-13	316
45-816919	REC45-816919	273	48-13702A46	SOL1571-150-21	316	48-831850A45	SOL1513-145-17	316
45-853648	REC45-853648	273	48-13703A46	SOL1512-153-21	316	48-832828A45	SOL1511-150-15	316
45518A3	REC45518A3	295-302	48-13703A46	SOL1572-150-21	316	48-832828A45	SOL1513-145-17	316
45518T1	REC45518T1	295-302	48-13704A46	SOL1511-153-23	316	48-832828A45	SOL1531-143-17	316
45589A3	REC45589A3	295-302	48-13704A46	SOL1571-148-23	316	48-832830A45	SOL1511-148-17	316
46-44292Q03	REC46-44292Q03	189-265	48-13705A46	SOL1572-148-23	316	48-832830A45	SOL1513-143-19	316
46-48748A1	REC46-48748T1	189	48-13706A46	SOL1571-145-25	316	48-832830A45	SOL1531-140-19	316
46-48748T1	REC46-48748T1	189	48-13707A46	SOL1572-145-25	316	48-832832A45	SOL1511-145-19	316
46-59112A2	REC46-72774A32	187	48-16312A46	SOL1531-145-15	316	48-832832A45	SOL1513-140-21	316
46-60367A1	REC46-96148A8	190	48-16314A46	SOL1531-143-17	316	48-832832A45	SOL1531-140-21	316
46-63450A2	REC46-72774A32	187	48-16314A46	SOL1551-148-16	316	48-832834A45	SOL1511-143-21	316

OEM	REF	PAG.	OEM	REF	PAG.	OEM	REF	PAG.
48-832834A45	SOL1513-140-23	316	54-12078	RM54-12078	293-298	6-6311002NZ	TRANSONBRAVO	298
48-832834A45	SOL1531-140-23	316	54-38863	REC54-38863	291-296-300			219-221-
48-834851A45	SOL1514-145-17	316	54-815504256	GS38320	221-222-227-237-239	60252A2	REC60252A2	225-235-241-250
48-834852A45	SOL1513-143-19	316	54-815504272	GS38320	233	60372A1	BAMC29-60372	180
48-834853A45	SOL1514-143-19	316	54-815504320	REC54-815504320	108-291-296-300	60372A2	BAMC29-60372	180
48-834854A45	SOL1513-140-21	316	54-815504372	GS38320	221	60426A1	HOT20971	246
48-834855A45	SOL1514-140-21	316	54-815504372	GS38322	221	60932A1	CEF500516K	299
48-90159A46	SOL1512-155-17	316	54-815504372	GS38322	221-227-230-237-239	60932A1	REC60932A4	299
48-90159A46	SOL1572-155-17	316	54-815504412	REC54-815504412	295	60932A4	CEF500516K	299
48101A1	BAMC20-72963	246	54-815504456	GS38310	229-233	60932A4	REC60932A4	295-299
48752T	REC48752T	261-265	54-815504456	GS38320	229	61811A3	BAMC20-61811A4	248
5-5000147CP	REC1623-8951A33	256	54-86049	REC54-86049	295-297-300	61811A4	BAMC20-61811A4	248
5-5000162CP	REC1623-8951A33	256	54-896332164	RM21325765	143	61851A3	BAMC20-61851A3	248
5-5000181CP	REC1623-8951A33	256	55131A5	REC55131A5	178	62092T	REC62092T	124
5-5000194CP	REC1623-8951A33	256	55538A2	BAMC-20-55538	218-245	623-815822A55	REC1623-815822A55	257
5-5010147CP	REC1623-8951A43	256	55989A9	CM55989	288	62898A1	BAMC29-62898	180
5-5010162CP	REC1623-8951A43	256	55989A9	CM55989A	288	63122A10	BAMC-1-63122	218-242
5-5010181CP	REC1623-8951A43	256	55989Q9	CM55989	288-291	63122A13	BAMC-1-63122	212-242
5-5010194CP	REC1623-8951A43	256	55989Q9	CM55989A	288	63122A14	BAMC-1-63122	218-242
5-5111200TP	REC1623-815822A47	257	55989Q9	REC55989Q9	109-285-291	63588A1	BAMC29-63588	178
5-5111300TP	REC1623-815822A47	257	55989Q9	REC55989Q9AL	108-285	65057A1	REC65057T1	157
5-5111400TP	REC1623-815822A47	257	55989Q9	REC55989Q9M	285	65057T1	REC65057T1	157
5-5111500TP	REC1623-815822A47	257	57-13457Q	REC57-13457Q	105-195-196-198	65533A1	REC65533A1	291
5-5121200TP	REC1623-815822A53	257	57-13458Q	REC966931	196-198	65603A12	HOT20962	241-244
5-5121300TP	REC1589-865440H52	255	57-32850	REC3852106	198	65603A3	HOT20962	244
5-5121300TP	REC1623-815822A53	257	57-34359	REC57-34359	198	65604A12	HOT20958	241-244
5-5121300TP	REC1656-8866A63	255	57-36356	REC57-36356	198	65604A4	HOT20958	244
5-5121400TP	REC1623-815822A53	257	57-37619T,Q	REC57-34359	198	66081A2	REC66081A2	259-269-271
5-5121500TP	REC1623-815822A53	257	57-45856	REC3858462	198	66688A1	REC31-66688A1	279
5-5231100NP	REC1589-865440H50	255	57-48120Q1	REC829207	198	68521A3	REC17177A1	175
5-5231100NP	REC1656-8866A55	255	57-48122Q1	REC57-48122Q	196-198	68521A4	REC17177A1	175
5-5231100TP	REC1589-865440H50	255	57-49043A1	REC57-49043A1	198	69354A2	REC69354A2	217-303
5-5231100TP	REC1656-8866A63	255	57-49211	REC57-64416	198	70125A02	REC70125A02	142
5-5231200NP	REC1589-865440H51	255	57-49213A1	REC3858462	198	70125A1	REC70125A02	142
5-5231200NP	REC1656-8866A55	255	57-52692	REC57-52692	198	70981A3	CEF500523	253
5-5231200TP	REC1589-865440H51	255	57-64032Q1	REC57-49043A1	198		REC70981A3	221-224-221-235-237-239-253
5-5231300NP	REC1589-865440H50	255	57-64416	REC57-64416	198	71464A01	REC71464A01	142
5-5231300NP	REC1656-8866A55	255	57-65607T	REC57-65607Q	198	72608T	MP425149	254
5-5441100TP	REC1589-865440H50	255	57-69143Q	REC3852106	198	72963A1	BAMC20-72963	246
5-5441100TP	REC1656-8M0046733	255	57-74271Q	REC966903	195-196-198	72963A9	BAMC20-72963	240-246
5-5441200TP	REC1589-865440H51	255	57-77274	REC966900	195-198	72964A1	BAMC20-76668	245
5-5441200TP	REC1656-8M0046733	255	57-78200Q1	REC57-78200Q1	196-198			
5-5441300TP	REC1589-865440H51	255	57-807755Q04	REC57-807755Q04	197	73813A1	HGE4870	218-219-221-225-235-240-241-250
5-5441300TP	REC1656-8M0046735	255	57-807755Q05	REC57-807755Q05	197			
5-5441400TP	REC1589-865440H50	255	57-816295Q	REC57-816295Q	104-195-196-198	73873A1	REC73873A1	292
5-5441400TP	REC1656-8M0046738	255	57-817113	REC57-817113	197	74639Q02	CEF500513K	299
5-5441500TP	REC1589-865440H52	255	57-861049Q	REC57-861049Q	197	74639Q02	REC74639Q02	291-296-299
5-5441500TP	REC1656-8M0046738	255	57-861757Q	REC57-861757Q	197	74905A3	REC17177A1	175
5-5441600TP	REC1589-865440H51	255	57-861758Q	REC57-861758Q	197	75832T	REC75832T	259-269
5-5441600TP	REC1656-8M0046738	255	57-861759Q	REC57-861759Q	197	75832T1	REC3850812	259-269
5-5441700TP	REC1589-865440H52	255	57-865615005	REC57-865615Q05	197	76214-4	CM762144	288
5-5441700TP	REC1656-8M0046682	255	57-865615010	REC57-865615Q05	197	76214-4	CM762144A	288
50-12782	REC3854190	151	57-865615Q01	REC57-865615Q01	197	76214-5	TEN00820	286
50-47454	REC50-97499A2	152	57-865615Q02	REC57-865615Q02	197	76214A2	CM762144	281
50-56886	REC3854190	151	57-865615Q03	REC57-865615Q03	104-105-197	76214A2	CM762145	288
50-65785A1	REC50-97499A2	152	57-865615Q04	REC57-865615Q04	104-105-197	76214A2	CM762145A	288
50-69865A1	REC3854190	151	57-865615Q06	REC57-865615Q06	197	76214Q5	CM762144	283
50-72550A2	REC50-97499A2	152	57-865615Q07	REC57-865615Q07	197	76214Q5	CM762144A	283
50-79604A3	REC50-97499A2	152	57-865615Q08	REC57-865615Q08	104-105-197	76214Q5	CM762145	275-270-288
50-805991	REC3916854	152	57-879172120	REC57-879172120	107-198	76214Q5	CM762145A	275-288
50-806963A2	REC50-806965A4	152	57-879194425	REC57-879194425	198	76214Q5	CM76214Q5	288
50-806965A2	REC50-8M0090697	152	57-882531	REC57-882531	198	76214Q5	REC76214Q5	284-285
50-806965A4	REC50-806965A4	152	57-882531T	REC57-882531T	198	76214Q5	REC76214Q5AL	109-284-285
50-806965A4	REC50-8M0090697	152	57-898101579	REC57-898101579	107-198	76325A2	REC76325A2	221-225-245-251
50-808011A05	REC50-808011A05	151	57-898101624	REC57-879194425	198	76351A04	HGE6351	241
50-80811A4	REC50-808011A05	151	57-8M0074767	REC57-8M007728	197	76351A04	HOT20971	219-225-235-241-246
50-812429A2	REC50-8M0090697	152	57-8M0088876	REC57-8M0088876	197	76351A04	HOT20971	246
50-863007A1	REC50-806965A4	152	57-8M0093495	REC57-8M0093495	198	76351A2	HOT20971	246
50-863007A1	REC50-863007A1	151	57-8M0097728	REC57-8M0097728	197	76514Q5	CM762145A	279
50-864340A2	REC3885317	151	57-91035Q1	REC57-91035Q1	195-196-198	76668A1	BAMC20-76668	245
50-864340A2	REC50-99418A2	151	57-93658Q	REC3858462	198	76668A3	BAMC20-76668	240-245
50-88671A1	REC50-808011A05	151	58217Q	REC58217	169	76771A2	HOT20978	219-235-241
50-8M0090697	REC50-8M0090697	152	58759A1	BAMC-1-58759	243	76771A2	REC76771A2	245
50-8M0095471	REC50-8M0095471	151	58759A10	BAMC-1-58759	243	76771A3	REC76771A2	245
50-99418A2	REC50-99418A2	151	58759A13	BAMC-1-58759	243	76788A1	BAMC20-72963	246
52-853594T	REC52-853594T	263-267-275	58759A14	BAMC-1-58759	225-243	76850A2	REC76850A2	304
52-865344A01	RM52-865344A01	277	59078Q3	REC59078Q3	181	77234A2	HOT20950	244
53-23720	REC53-23720	192	59498A1	BAMC29-59498	180	77234A7	HOT20950	235-244
53-29641	REC53-29641	265-273	59501A1	REC59501A1	192	78403A1	REC78403A2	153
53-805272	REC53-805272	308	59826A3	REC59826A3	303	78403A2	REC69729	153
53-815949	REC53-815949	108-307	59830A7	REC59830A7	259-269-271	78403A32	REC78403A2	153
53-87843	RM53-87843	185-295-297	6-6010000CP	TRANSONALPHAI	291	78458A1	CEF500520K	300
53-88242	REC53-88242	279-281-283	6-6111002LP	TRANSONALPHA2G	291	78458A1	REC78458A1	297-300
53114A1	CEF500524	253	6-6211002NZ	TRANSONBRAVO	298	78984A08	REC78984A08	177
53114A1	REC53114A1	219-225-253						

OEM	REF	PAG.	OEM	REF	PAG.	OEM	REF	PAG.
78984A1	REC78984A08	177	807166A3	REC807166A3	253	821631Q1	CM821631A	291
78985A1	BAMC29-78985	178	807252Q3	REC807252Q3	182	821631Q1	REC821631Q1	284-285
802630T	REC802630T01	129	807252Q4	REC807252Q4	182	821631Q1	REC821631Q1AL	108-109-284-285
802630T01	REC802630T01	129	807252Q5	REC807252Q5	182	822777Q1	CM46399	288
802632T	REC802632T	130	807252T1	REC8M0089715	182	822777Q1	CM46399A	288
802632T	REC9-33304	131-150	807252T2	REC8M0091470	182	823426A1	REC823426A1	139-140-141-142
804483T	REC3854548	168	807252T4	REC807252Q4	182	823427A1	REC823427A1	137
804626R02	REC804626R02	132	807289A1	REC425062	254	824324T	MP425024	254
805016A1	REC805016A1	142	807371T1	RM807371T1	184	824330T	MP425036	254
805025A2	REC3858261	127	807476A6	MAR3320PAR	248	827682T	REC827682T	126
805025A2	REC861155A6	127	807652T	REC807652T	154	828151A1	REC3854138	158
805101T	REC805101T	283	807653T	REC807653T	154	828692A1	REC828692A1	269-271
805182A1	RM805182A1	283	807729T	MP154516	193	828830A2	REC828830A2	275
805185A3	REC805185A3	176	807729T	REC8M0153706	193	834832T2	REC8M0064021	154
805185A36	REC805185A36	174-176	807731T	REC861579	186	84-813720A10	REC15-801	167
805185A37	REC805185A37	174	807757T	REC807757T	193	84-813720A11	REC15-601	167
805217A1	REC3850396	144	807914A1	MAR988	245	84-813720A13	REC15-405	167
805218T	REC3850397	148	807914A1	MAR988	245	84-813720A2	REC15-804	167
805222A1	REC805222A1	173-176	807929A1	REC807929A1	273	84-813720A3	REC15-804	167
805223T	REC805223T	148	807952A1	REC807952A1	129-149-150	84-813720A4	REC15-804	167
805224A1	REC3855194	145-149-150	807964A1	REC807964A1	173-176	84-813720A5	REC15-401	167
805225A1	REC9-33303	131-149-150	807988A03	MAR988	227-230-237-239-245	84-813720A5	REC15-402	167
805226A1	REC8M0125617	144	807988A03	MAR988	227-230-237-239-245	84-813720A7	REC15-604	167
805227A1	REC805227A1	130-150	807988A03	MAR988	239-247	84-813720A8	MAG15-602	167
805298A1	REC805298A1	142	807988A03	SED3092600	247	84-813720A8	REC15-801	167
805320A03	REC805320A03	146-293-298	807988A03	SED3095500	247	84-813720A9	REC15-801	167
805370A1	RM45-41629A2	283	807988A2	MAR988	245	84-816608A1	REC15-815	167-175-176
805447T	REC805884T	153	807988A2	MAR988	245-251	84-816761A15	MAG15-803	167
805536A2	REC805536A2	259-269-271	807988A3	SED3092600	227	84-816761A15	REC15-804	167
805544T	REC8M0077616	145	808483T3	REC3854548	168	84-816761A2	MAG15-803	167
805602A1	SED3092000	247	808504T1	REC65L-13915-00	113	84-816761A2	REC15-804	167
805602A2	SED3093300	247	809463A1	REC3859054	157	84-816761A4	REC15-804	167
805629A1	REC805629A1	221-250	81-64851	REC64851	170	84-816761Q13	REC15-405	173
805656A2	REC3858261	127	811536T	REC811536T	136	84-816761Q16	REC15-601	173-174-176
805656A2	REC861155A6	127	811575T	MP425113	254	84-816761Q17	REC15-804	173-174
805656A5	REC3858261	127	811637T	REC3854003	162	84-816761Q7	REC15-604	167
805656A6	REC861155A6	127	811639T	REC3854001	145-162-173	84-816781A15	MAG15-803	167
805656A6	REC3858261	127	812454A1	REC862048A1	124	84-816781A15	REC15-804	167
805656A6	REC861155A6	127	812454A3	REC862048A1	124	84-816781A15	REC15-804	167
805759A1	REC805759Q01	168	814263A1	GS38105	303	84-816781A15	REC15-804	167
805759A2	REC805759Q01	168	814281A7	REC8M0052939	292	84-816781A15	REC15-804	167
805759A5	REC805759Q01	168	814604A1	REC814604T1	275	84-817376T01	REC84-817376T01	173
805759Q01	REC805759Q01	168-174	814606 1	REC44-8146061	275	84-863656A1	REC15-804	167
805759T1	REC805759Q01	168	814819A2	REC814819A2	259-269	84-863656A2	REC15-813	167-175
805759T2	REC805759Q01	168	814819A3	REC59830A7	277	842725A3	REC15-606	175
805884T	REC805884T	153	814819A7	REC814819A7	271	850484T	REC8M0073435	125
806031A2	RM806031A2	295	815303T	REC815303T	297	850484T	REC3854331	168
806034A2	RM806034A2	293-298	815407A2	REC815407A2	168	8507522+10-31700	REC3854332	168
806105Q1	CM806105	267-275	815407Q02	REC815407A2	168-174	851956A1	REC8507522	292
806105Q1	CM806105A	267-275	815471T1	REC815471T1	300	852956A1	REC853998A1	131
806105Q1	REC806105Q1	284-285	815919A1	REC815919A1	273	853678T	REC38589A1	130-149
806105Q1	REC806105Q1AL	109-284-285	815935A7	REC815935A7	307	853998A1	REC853678T	144
806188A1	CM806105	288	815954A7	REC815954A7	307	853998A1	REC853998A1	131
806188A1	CM806188	288	816148A1	REC17177A1	175	853998T	REC853998A1	131
806188A1	CM806188A	288	816219A5	HOT20937	242	857006A3	REC8M0064021	154
806189Q1	CM806189	288-307	816431A1	CEF500515K	299	85784A1	REC85784A1	142
806189Q1	CM806189A	288-307	816431A1	REC816431A1	295-299	85785-2	REC805298A1	142
806189Q1	REC806189Q1	284-285	816597A1	REC816597A1	273	85785A2	REC85785A2	142
806189Q1	REC806189Q1AL	109-284-285	816629Q	REC90508-ZW1-003	263	85785T	REC805298A1	142
806190A1	CM806190	308	817119A1	REC3860769	153	859210T	REC881879T11	147
806190A1	CM806190A	308	817119A4	REC3860769	153	859604A1	REC881879T11	147
806190Q1	CM806190	288	817119A4	REC78403A2	153	86-865202T	REC86-865202T	158
806190Q1	CM806190A	288	817275Q05	RM817275A1	273	860235A03	REC860235A03	222-243-252
806190Q1	REC806190Q1	284-285	817377T	REC817275Q05	109-191	860235A04	HOT20956	221
806190Q1	REC806190Q1AL	284-285	817378T	REC817377	176	860246A10	MAR246	244
806191T	REC806191T	307-308	818349T1	REC3854002	161	860246A15	MAR246	237-244
806193A20	RM806193A48	185	818383T	REC818349T1	263-267-275	860246A3	MAR246	244
806193A38	RM806193A48	185	818763A10	REC861677T	124	860246A9	MAR246	244
806193A48	RM806193A48	185	821509T01	REC818763A10	263-267-275	860256A4	REC8M0061381	178
806235A04	HOT20956	242	821629Q1	REC882751A04	158	860349A1	REC860349A1	129-150
806490T	REC806490T	148	821629Q1	CM821629	269-271-288	861006A1	REC8M0061381	178
806612T	REC806612T	145	821629Q1	CM821629A	269-271-288	861126A1	REC861126A1	129-149-150
806673T	REC806673T1	161	821629Q1	REC821629Q1	284-285	861155A2	REC861155A3	127
806673T1	REC806673T1	161	821629Q1	REC821629Q1AL	284-285	861155A3	REC861155A3	127
806867A12	REC860235A03	243	821630A1/Q1	CM821630	288	861155A5	REC3858261	127
806867A3	REC860235A03	243	821630A1/Q1	CM821630A	288	861155A5	REC861155A6	127
806867A8	HOT20956	242	821630Q1	CM821630	277	861155A6	REC3858261	127
807078A6	MAR078	244	821630Q1	CM821630A	277	861155A6	REC861155A6	127
807078T09	MAR078	244	821630Q1	REC821630Q1	284-285	861156A03	REC861156A03	129
807078T10	MAR078	239-244	821630Q1	REC821630Q1AL	284-285	861156A04	REC861156A04	129
807130A4	RM807130A4	227-229-233-237-239-250	821631A1	CM43994	288	861156A1	REC861156A1	126
807151A14	REC46-807151A14	191	821631A1	CM821631	288	861249A1	REC861249A1	144
807166A1	REC807166A1	227-229-231-233-237-239-253	821631A1	CM821631A	288	861260T	REC9-33302	131
			821631Q	CM821631	296	861493A07	BAMC29-47587	177
			821631Q	CM821631A	296	861493A07	BAMC29-60372	180
			821631Q1	CM821631	291	861493A3	BAMC29-47587	177

OEM	REF	PAG.	OEM	REF	PAG.	OEM	REF	PAG.
861523A9	REC861523A9	303	87-808009A2	REC87-808009A2	292	888761Q03	RECKITMBRAVO23AL	109-281-284-286
861676A1	REC8M0073435	125	87-808009A3	RM8M0052936	292	888761Q03	RECKITMBRAVO23M	284-286
861676T09	REC8M0073435	125	87-814281A5	REC87-814281A5	292	888761Q03	RECKITMBRAVO23ZN	284-286
861677T	REC861677T	124	87-815425T	REC8M0068784	147	888761Q04	RECKITMBRAVO3AL	109-283-284-286
862030T	REC862030T01	154	87-858679T2	REC87-858679T2	160	888761Q04	RECKITMBRAVO3M	284-286
862030T01	REC862030T01	154	87-859032T02	REC87-859032T02	160	888761Q04	RECKITMBRAVO3M	284-286
862031T	REC862031T1	153	87-864252	REC87-864252	147	888761Q04	RECKITMBRAVO3ZN	284-286
862031T1	REC862031T1	153	87-864252A01	REC87-864252A01	147	889514A01	REC8M0052939	292
862048A1	REC862048A1	124	87-892150Q02	REC87-892150Q02	174	89-18080	REC3853869	157
862077A1	REC862077A1	124	87-8M0052935	REC87-808009A2	292	89-68258A4	REC852565	157
862132T	REC862132T	277	87-8M0052936	RM8M0052936	292	89-805188A1	REC89-818999A2	157
86234A3	REC86234A4	124	87-91941A8	REC87-91941A8	160	89-818864	REC89-96158T	157
86234A4	REC86234A4	124	87114A19	MAR246	244	89-818864T	REC89-96158T	157
862351T	REC862351T	187	87290A26	REC87290A23	177	89-818997A1	REC89-818997A1	157
86246A1	REC86246T	124	87290A4	REC87290A4	178	89-818997T1	REC89-818997A1	157
86246T	REC86246T	124	87399A2	REC87399A2	306	89-818999A1	REC89-818999A2	157
86247A2	REC86247T	124	87399A2	REC87399A2	308	89-818999A2	REC89-818999A2	157
86247T	REC86247T	124	87399A3	REC87399A3	307	89-853654A1	REC3853869	157
862548A1	REC42419A1	156	87581T	REC195141	176	89-853654A1	REC852565	157
863077T	REC863077T	154	879150A87	REC21622232	175-176	89-91975	REC89-96054T	157
86307AR01	REC863077T	154	879194A01 & A02	REC30-879194A01	296	89-96054	REC89-96054T	157
863444T1	RM863444T1	179	879194T46	REC879194T46	302	89-96054T	REC89-96054T	157
863457A2	RM863457A2	178	88-11178A01	BS2142	158	89-96158	REC89-96158T	157
863631T1	RM863631T1	179	88-212619	BS5296	159	89-96158T	REC89-96158T	157
863786A1	REC22-863786A1	234	88-79023A91	RM88-79023A91	158	89-99253	REC3853869	157
863802T2	REC863802T2	179	88-79023A94	BS5140	159	89011A8	MAR078	244
864148A01	RM21325765	143	88-79023T10	REC88-79023T10	158	891736T	REC891736T	156
864244A2	REC864244A2	277	88-832969T05	AM603905	159	89690T	REC89690T	184
864281A01	REC864281A2	270	88-832969T10	AM603910	159	898253T22	REC898253T22	169-175
864281A2	REC864281A2	269-271	88-832969T15	AM603915	159	898253T23	REC898253T23	169-175
864282T	REC864282T	271	88-832969T20	AM603920	159	898253T24	REC14639382	162
864297T01	REC864297T01	146	88-832969T30	AM603930	159	898253T27	REC3854002	161-173
864308T01	MAR735	243	88-8M0129528	BS5185	159	8M0020941	REC17-8M0084681	263-267-275
864309T01	MAR309	245	88-8M0129530	BS5187	159	8M0029482	REC300-8M0044991	161
864309T02	MAR309	229-233-245-251	88-8M0129531	BS5189	159	8M0030022	REC8M0082988	146
864309T02	SED3095400	229-233-247	88-8M0129533	BS5175	159	8M0032176	REC876037	158
864363A1	RM864363A1	292	88-8M0129534	BS5177	159	8M0032834	REC8M0032834	265
864364A1	RM864364A1	292	88-8M0129535	BS5181	159	8M0042641	REC8M0042641	265
864591T02	MAR591	229-233-245-251	88-8M0129560	BS5182	159	8M0047215	REC8M0047215	128
864591T02	SED3095500	229-233	88-8M0130941	BS5183	159	8M0052939	REC8M0052939	292
864612T01	MAR612	229-243-248-249-252	88-8M2011907	BS2138	158	8M0054588	REC3861985	161
864625T	REC864625T	194	88-93582	BS2143	158	8M0054726	REC8M0054726	144-150
864650A05	REC8M0047215	128	881070T	REC8M0125617	144	8M0056956	CEF500167	188
864650A13	REC8M0047215	128	88183A12	REC865380A13	155	8M0056956	REC15000K	188
86481A2	REC864281A2	271	88183A12	REC865380A25	155	8M0056956	SHE15000K	188
864856A1	REC3850396	144	881879A6	REC881879T11	147	8M0057679	REC8M0133370	129
864908A1	BAMC-20-864908A1	229-233-249	881879T11	REC881879T11	147	8M0057686	REC8M6002428	130
864929A3	HGE4929	229-233	88243A3	REC88243A3	279	8M0057697	REC876037	158
864929A3	MAR929	248	88243A3	REC88243A3	283	8M0058164	REC8M0058164	125
865049T01	MAR735	243	882751A04	REC882751A04	158	8M0058389	REC22-67892A05	263-267-275-277-279
865328A01	RM865328A01	293	882751A1	REC3854138	158	8M0061381	REC8M0061381	178
865329A02	REC865329A02	292-304	882751A2	REC3854138	158	8M0062084	REC3854311	169
865380A13	REC862548A1	156	883166A2	REC883166A2	156	8M0062406	CEF500509K	299
865380A13	REC865380A13	155	884794A02	REC21622232	176	8M0062406	REC86840A05	299
865380A25	REC865380A13	155	884794A1	REC21622232	176	8M0062440	RM8M0062440	298
865425A03	RM865425A03	277	8866A64	RM1656-8866A17	279	8M0062568	RM43881A14	291
865436A02	REC865436A02	292-300	88751A02	REC40005334	175	8M0062770	REC8M0062770	126
865436A02	RM19543A10	292-300	88751A03	REC40005334	175	8M0062770	REC8M0062770	128
865437A02	REC865437A02	292-300	888751A1	REC40005334	175	8M0062771	REC8M0103289	127-128
865491A01	REC864281A2	271	888756Q02	TENKITALPHAONE/1	263-267-287	8M0066646	REC8M0093480	181
865496A01	REC865496A02	277	888756Q01	CMALPHAKITA	289	8M0067062	TENO1320T	287
865496A02	REC865496A02	271	888756Q01	CMALPHAKITM	289	8M0067268	REC57-8M0093495	198
865503T	REC865503T	271	888756Q01	TENKITALPHAONE/2	287	8M0067292	REC8M0093480	181
865735A02	MAR735	233-243	888756Q02	CMALPHAGEN1KITA	289	8M0067625	TENO1320T	287
865876A01	REC865876A01	283	888756Q02	CMALPHAGEN1KITM	289	8M0068784	REC8M0068784	147
866136A01	RM866136A01	277	888756Q03	CMALPHAKITA	289	8M0069803	REC802630T01	129
866169A01	REC866169T01	126	888756Q03	CMALPHAKITM	289	8M0073409	REC17-8M0073409	291
866169T01	REC866169T01	126	888756Q03	RECKITMALPHA2AL	2865	8M0073435	REC8M0073435	125
866169Y01	REC866169T01	128	888756Q03	RECKITMALPHA2M	284-286	8M0077616	REC8M0077616	145
866170A01	REC866170A01	127-128	888756Q03	RECKITMALPHA2ZN	284-286	8M0080805	REC8M0080805	291-296-306-307-308
866171A01	REC35-866171A01	128	888756Q04	TENKITALPHAONE/2	287	8M0082479	PREKM63706	301
866200A01	REC806034A1	293-298	888756Q04	RECKITMALPHA1AL	286	8M0082480	PREKM63707	301
866322A01	RM866322A01	293-298	888756Q04	RECKITMALPHA1M	284-286	8M0082481	PREKM63708	301
86754T	RM86754T	283	888756Q04	RECKITMALPHA1ZN	284-286	8M0082482	PREKM63709	301
86779A1	REC86779A1	277	888758Q01	CMBRAVO1KITA	279-289	8M0082483	PREKM63710	301
86840A05	CEF500509K	299	888758Q01	CMBRAVO1KITM	279-289	8M0082484	PREKM63711	301
86840A05	REC86840A05	297-299	888758Q01	TENKITBRAVOI	279-287	8M0082485	PREKM63712	301
86840A3	CEF500509K	299	888758Q02	RECKITMBRAVO1AL	286	8M0082485	PREKM63713	301
86840A3	REC86840A05	299	888758Q02	RECKITMBRAVO1M	284-286	8M0082486	PREKM63714	301
87-18286A43	REC87-18286A43	160	888758Q02	RECKITMBRAVO1ZN	284-286	8M0082488	PREKM63715	301
87-19674A1	REC87-19674A1	160	888761Q01	CMBRAVO2Y3KITA	281-289	8M0082489	PREKM63716	301
87-71831	REC71831	170	888761Q01	CMBRAVO2Y3KITM	281-289	8M0082490	PREKM63717	301
87-76416A1	REC3853839	157	888761Q02	TENKITBRAVOII-III	281-287	8M0082491	PREKM63718	301
87-805605A1	REC87-805605A1	147	888761Q02	CMBRAVO3KITA	283-289	8M0082492	PREKM63719	301
87-808009A1	RM8M0052936	292	888761Q02	CMBRAVO3KITM	283-289	8M0082493	PREKM63720	301
			888761Q02	TENKITBRAVOIII-04	283-287			

OEM	REF	PAG.	OEM	REF	PAG.	OEM	REF	PAG.
8M0082494	PREKM63721	301	8M0155633	REC8M0155633	186	99438A1	RM99438A1	183
8M0082495	PREKM63722	301	8M2000229	REC10-53728	231-234	99746A17	HOT20952	227-230-243
8M0082496	PREKM63723	301	8M2000819	REC27-33395	209-234	99746A17	MAR746	227-230-243
8M0082497	PREKM63724	301	8M2003959	REC8M2003959	145	99746A3	HOT20952	243
8M0082529	PRE53006	301	8M2003959	REC8M2003959	231-234	99746A3	MAR746	243
8M0082530	PRE53007	301	8M2004414	REC8M2004414	231-234-251	99746A8	HOT20952	243
8M0082531	PRE53008	301	8M2011027	REC8M2011027	263-267-275-279	99746A8	MAR746	243
8M0082532	PRE53009	301	8M2015937	REC8M2015937	269-271	99798A18	HOT20956	242
8M0082533	PRE53010	301	8M2015938	REC8M2015938	269-271	F16900148	REC982209	168
8M0082534	PRE53011	301	8M6000623	REC8M6000623	148	F16900083	REC8M6001249	170
8M0082535	PRE53012	301	8M6000634	REC8M6000634	147	F16900023	REC8M6001249	170
8M0082536	PRE53013	301	8M6000652	REC8M6000652	147	F16900031	REC33662	170
8M0082537	PRE53014	301	8M6000652	REC8M6000652	147	F16900031	REC8M6001219	170
8M0082538	PRE53015	301	8M6001217	REC8M6001217	170	F16900032	REC8M6001249	170
8M0082539	PRE53016	301	8M6001218	REC33662	170	F16900040	REC8M6001217	170
8M0082540	PRE53017	301	8M6001219	REC8M6001219	170	F16900044	REC834975	169
8M0082541	PRE53018	301	8M6001222	REC898253013	169-175	F16900152	REC97258A1	148
8M0082542	PRE53019	301	8M6001224	REC89825302	169	F16900184	REC835702	168
8M0082543	PRE53020	301	8M6001249	REC8M6001249	170	F16900185	REC392-9766	168
8M0082544	PRE53021	301	8M6001250	REC391-5090	170	F16900186	REC3853801	169
8M0082545	PRE53022	301	8M6001251	REC58217	169	F16900189	REC8M6001249	170
8M0082546	PRE53023	301	8M6001252	REC8M6001252	169	F16900190	REC3853801	169
8M0082547	PRE53024	301	8M6001253	REC3854549	169	F16900198	REC97258A1	148
8M0082577	PRE3300C05	301	8M6001253	REC3854549	173	F16901224	REC89825302	169
8M0082578	PRE3300C06	301	8M6001254	REC3854261	169	GM10482803	REC3858984	162
8M0082579	PRE3300C07	301	8M6001254	REC3854261	173			
8M0082580	PRE3300C08	301	8M6002428	REC8M6002428	130			
8M0082581	PRE3300C09	301	8M6003194	REC8M6003194	145			
8M0082582	PRE3300C10	301	8M6005225	REC879194401	185			
8M0082583	PRE3300C11	301	8M6500024	REC8M6500024	193			
8M0082584	PRE3300C12	301	90576A4	REC13524A6	169			
8M0082585	PRE3300C13	301	90736A24	REC90736A24	177			
8M0082586	PRE3300C14	301	90746A1	REC805759Q01	168			
8M0082587	PRE3300C15	301	907964A1	REC807964A1	176			
8M0082588	PRE3300C16	301	91-12037	REC91-12037	313			
8M0082589	PRE3300C17	301	91-17256	REC91-17256	314			
8M0082590	PRE3300C18	301	91-17257T	REC90490	314			
8M0082591	PRE3300C19	301	91-17273	RM91-17273	313			
8M0082592	PRE3300C20	301	91-17275A1	REC91-31107T	313			
8M0082593	PRE3300C21	301	91-17275A1	RM91-17275A1	313			
8M0082594	PRE3300C22	301	91-17302	RM91-17302	313			
8M0082595	PRE3300C23	301	91-36569T	REC91-36569T	310			
8M0082596	PRE3300C24	301	91-43579	REC91-43579	313			
8M0082597	PRE3300C25	301	91-45497A1	REC91-45497A1	312			
8M0082598	PRE3300C26	301	91-56048001	REC91-56048001	312			
8M0082599	PRE3300C27	301	91-56775T	REC91-56775T	312			
8M0082600	PRE3300C28	301	91-60523	REC91-60523	312			
8M0082601	PRE3300C29	301	91-60526T	REC91-60526T	312			
8M0082602	PRE3300C30	301	91-61077T	REC91-61077T	312			
8M0082603	PRE3300C31	301	91-78310	REC91-78310	312			
8M0082604	PRE3300C32	301	91-8053741	REC90490	314			
8M0082605	PRE3300C33	301	91-805475A1	REC91-805475A1	312			
8M0082606	PRE3300C34	301	91-818162	REC91-818162	312			
8M0082607	PRE3300C35	301	91-888863	REC91-888863	173			
8M0082608	REC8M0082988	146	91823A3	REC17177A1	175			
8M0084523	REC882571	154	92497A3	REC78403A2	153			
8M0084884	REC25-8M0084884	183	93320A10	REC93320A15	237-248			
8M0087834	REC8M0087834	144	93320A13	MAR3320PAR	227-237-239-248			
8M0089715	REC8M0089715	182	93320A15	REC93320A15	248			
8M0091470	REC8M0091470	182	93320A5	MAR3320PAR	248			
8M0092489	REC8M0092489	160	93322A12	HOT20985	249			
8M0093480	REC8M0093480	181	93322A12AV	HOT20985	227-237-239			
8M0093561	REC8M0093561	181	94989A6	RM94989A6	291			
8M0094406	REC879194401	185	94998A4	REC94998A4	259			
8M0095310	REC8M0095310	146	95862A5	BAMC-1-95862	221-242			
8M0095310	REC8M0095310	293	96705A1	REC96705A1	219-242			
8M0095310	REC8M0095310	298	97-257	REC806490T	148			
8M0095468	REC8M0142695	145-231	97-8M0151541	TEN01320T	287			
8M0095953	REC8M0095953	231	97257A1	REC806490T	148			
8M0098619	REC8M0098619	143	97258A1	REC97258A1	148			
8M0111642	REC8M0111642	193	97399A2	REC862048A1	124			
8M0113733	REC46-8M0113733	185	97432A2	REC97432A2	217-303			
8M0113734	REC46-8M0113734	185	98-8M0121940	REC98-8M0121940	191			
8M0113736	REC46-8M0113736	185	98230A1	REC98230A1	293-298			
8M0115149	RM807130A4	231-250	98504A3	HOT20970	227-237-239-246			
8M0125617	REC8M0125617	144	98504A3	REC98504A3	23-239-2467			
8M0129714	REC8M0155633	186	98562A6	HOT20937	224-242-246-251			
8M0133370	REC8M0133370	129	98703A26	REC98703A26	308			
8M0142542	REC8M0142542	148	98703A3	REC98703A3	306			
8M0142695	REC8M0142695	145	98704A26	REC98704A26	308			
8M0144930	REC8M0144930	160	98704A3	REC98704A3	306			
8M0148530	REC8M0148530	186	99155T2	REC99155T2	182-224			
8M0148530	SHEP1016	186	99356A1	RM99356A1	184			
8M0148668	REC8M0148668	148-223	99356A2	REC99356A2	184-253			
8M0150234	TEN01320T	287						
8M0153706	MP514516	193						
8M0153706	REC8M0153706	193						