

SISTEMA ALIMENTACIÓN Y FILTRACIÓN 384

ACEITE	392
ACELERADOR - CABLE	430
BOMBA DE COMBUSTIBLE	392
BOMBA DE COMBUSTIBLE ELÉCTRICA	393
BOMBA DE COMBUSTIBLE MECÁNICA	392
BOMBA DE COMBUSTIBLE - JUNTAS	393
BOMBA DE COMBUSTIBLE - KIT	393
MEMBRANAS	394
MEMBRANAS - GUÍA	395
VÁLVULA	394
VST - JUNTAS	394
CARBURADOR	396
AGUJA - KIT	398
BOYAS	397
CARBURADOR COMPLETO	396
CARBURADOR - KITS	396
GUÍA KITS DE CARBURADORES	398
KIT DE VÁLVULA	398
RETENEDOR	398
COMPONENTES TANQUE Y CONECTORES	384
CONECTOR DE DEPÓSITO	384
PASAMAMPAROS	385
FILTRO DE ACEITE	391
JUNTA TAPÓN DEL CARTER	391
FILTRO DE COMBUSTIBLE Y ELEMENTOS	385
BRACKET	385
FILTRO COMBUSTIBLE - SEPARADOR AGUA	385
FILTRO DECANTADOR, VASO TRASPARENTE	386
FILTRO COMBUSTIBLE - EN LÍNEA	388
LLAVES PARA FILTRO	388
RACOR DE LATÓN	388
FILTRO COMBUSTIBLE - CARBURADOR	390
VST - FILTRO	390
FILTRO COMBUSTIBLE ALTA PRESIÓN	390
INYECTORES	395
INYECTOR	395
PLATINOS Y CONDENSADORES	426
CONDENSADORES Y PLATINOS	426
GUÍA	427
KITS	427

SISTEMA ELÉCTRICO 399

BOBINAS	400
BUJÍAS	401
EVINRUDE	403
JOHNSON	401
JUEGOS DE CABLES ALTO RENDIMIENTO	404
PIPA	405
CDI Y CAJAS NEGRAS	414
DESCONECTORES DE SEGURIDAD	422
LLAVES DE ARRANQUE	409
MOTORES DE ARRANQUE	405
GUÍA	408
MUELLE DE ARRANQUE	408
MUELLE SEGURO	408
UÑAS ARRANQUE MANUAL	409
REGULADORES Y RECTIFICADORES	411
GUÍA	414
SENSORES	399
SENSOR CMP	399
SENSOR IAC	399
SENSOR MAT/MAP	399
SOLENOIDE RELE	409
RELE DE TRIM	410
STARTOR	418
GUÍA CAJA NEGRA, STARTOR, TRIGGER	420
TRIGGER	417
TRIM, TILT & POWER TRIM	423
INSTALACIÓN ELÉCTRICA	423
KIT EXTRACTOR DE TAPONES TRIM	426
POWER TRIM COMPLETO	425
TAPÓN PISTÓN	426
TRIM COMPLETO	423
TRIM - SENSOR	425

SISTEMA DE GOBIERNO 428

INTERRUPTORES PARA MANDOS	429
ARNÉS	430
CABLES DE CONTROL	430
EXTENSIÓN ARNÉS	430
INTERRUPTOR MANDO	429
MANDOS DE CONTROL	428
MANDO LATERAL	428
MANDO PARA CONSOLA	429

SISTEMA DE REFRIGERACIÓN 431

ANODOS	455
ÁNODO CANADA METAL	455
ÁNODO RECMAR	458
ÁNODO TECNOSEAL	459

BOMBA DE AGUA	445
CASQUILLO	447
CIRCLIP	447
CUERPO	445
GUÍA BOMBAS DE AGUA	453
JUNTA TÓRICA	448
JUNTAS	449
JUNTAS BASE	446
KIT DE REPARACIÓN	449
TAPA IMPULSOR	448
TUBOS AGUA DE CULATA	455
GUÍA DE IMPULSORES	440
CHAVETA	441
KITS DE RETENES Y JUNTAS	441
GUÍA AROS TÓRICOS	442
RETENES	443
RETENES - GUÍA	444
LÍQUIDO INHIBIDOR DE LA CORROSIÓN	431
TERMOSTATO	432
ARANDELA	438
ASIENTO	436
ASIENTO VÁLVULA	438
CAMISA	438
CUBIERTA	436
DIAFRAGMA	438
GRUESO	436
GUÍA	439
JUNTAS	436
JUNTAS TAPA DE REFRIGERACIÓN	437
KIT TAPÓN	439
NIPLE	438
RESORTE	437
RETÉN MUELLE	437
TAPA	438
TERMOSTATO	433
TERMOSTATO - DESPIECES	432
TERMOSTATO - KIT	434
VÁLVULA ANTIPRESIÓN	437

PARTES DEL MOTOR 463

CIGÜEÑAL	466
BIELAS	466
COJINETES CABEZA DE BIELA	469
COJINETES CENTRALES	469
COJINETES INFERIORES	470
COJINETES PIE DE BIELA	468
COJINETES SUPERIORES	469
GUÍA COJINETES	470
GUÍA RETENES	468
RETENES	467
RETENES - KITS	467
DESPIECE MOTOR DE 4 TIEMPOS	463
CORREAS DE DISTRIBUCIÓN	481
JUNTAS DE MOTOR 4 TIEMPOS	464
BASE DE MOTOR	465
CULATA	464
CULATA - GUÍA	464
CULATA - KIT	465
JUNTAS CUERPO DE MARIPOSA	466
JUNTAS RETÉN SUPERIOR	466
JUNTAS TAPA DE TERMOSTATO	465
JUNTAS VÁLVULA DE PRESIÓN	466
TAPA DE BALANCINES	465
JUNTAS DE MOTOR 2 TIEMPOS	475
BASE DE MOTOR	480
CULATA	475
CULATA - GUÍA	479
CULATA - KIT	477
PISTONES	472
KITS DE PISTONES	473

SISTEMA ESCAPE Y ADMISIÓN 482

SISTEMA DE ADMISIÓN	484
JUNTAS BASE RETÉN	487
JUNTAS BOMBA DE ACEITE	487
JUNTAS CAJA Y BASE DE LENGÜETA	486
JUNTAS CARBURADOR - COLECTOR ADM.	485
JUNTAS COLECTOR	486
JUNTAS CUERPO PALOMILLA - COLECTOR	485
JUNTAS DE ADMISIÓN A CARBURADOR	485
JUNTAS GUÍA CADENA	487
JUNTAS SILENCIADOR	488
JUNTAS TAPA PASO AGUA BLOQUE	484
JUNTAS TAPA TRANSFERENCIA CROSSFLOW	485
RETENES DE ACEITE	489
JUNTAS TAPÓN DE DRENAJE	489
SISTEMA DE ESCAPE	482
JUNTAS	482
JUNTAS CUERPO DE ESCAPE INTERMEDIAS	483
RETENES CUERPO DE ESCAPE	483
JUNTAS DE CARTER	484

UNIDADES DE TRANSMISIÓN 490

CARCARA	493
COLA COMPLETA	490
GUÍA DE COLAS	493
HERRAMIENTAS DE COLA	494
EXTRACTOR DE COJINETES Y HÉLICES	494
EXTRACTOR DE PIÑONES	494
HERRAMIENTAS VOLANTE DE MOTOR	495
KIT HERRAMIENTAS	494
KIT LLAVE HÉLICE	495
LLAVE TUERCA DIÁBOLO	494
LLAVE TUERCA EJE VERTICAL	495
DESPIECE COLAS 4 TIEMPOS	496
J4, J5, J6	496
J10, J15	498
J25	500
J25, J30, J40, J50	502
DF40, DF50	504
J/BJ 60, 70	506
J/BJ 90, 115, 140	507
J/BJ 200, 225, 250	508
DESPIECE COLAS 2 TIEMPOS	509
4, 4.5, 5, 6, 7.5, 8	509
9.9, 15	510
25, 28	511
20, 35	512
40, 50	514
40, 60	516
40, 60, 75	518
V4	520
V4/V6	524
V4/V6 O	526
V4/V6 M	528
V6	530
PIEZAS TRANSMISIÓN	532
CASQUILLO BASCULANTE	539
COJINETE BOMBA DE ACEITE	539
COJINETE BOMBA DE AGUA	541
DIÁBOLO	540
DIÁBOLO - COJINETE	540
DIÁBOLO - TÓRICA	540
EJE HÉLICE	538
EJE TRANSMISIÓN INFERIOR	537
EJE TRANSMISIÓN INFERIOR - COJINETES	537
EJE TRANSMISIÓN SUPERIOR	538
EJE TRANSMISIÓN SUPERIOR - COJINETES	538
GUÍA COJINETES DE COLA	536
KITS DE PIÑONES	532
PAÑADOR	534
PIÑÓN ATAQUE - ARANDELA	533
PIÑÓN ATAQUE - GRUESO	533
PIÑONES ATAQUE	533
PIÑONES MARCHA ATRÁS	532
PIÑONES MARCHA AVANTE	532
SELECTOR	533
SELECTOR - MUELLE	534
SELECTOR - PASADOR	534
SELECTOR - VARILLA	534
SELECTOR - GUÍA	535
TORNILLO DRENAJE	540
TUBO DE AGUA	540
VARILLA DE CAMBIO - ARO TÓRICO	539
VARILLA DE CAMBIO - FUELLE	539
VARILLA DE CAMBIO - TUERCA	539
KIT REPARACIÓN COLA	541
CAMBIO ELÉCTRICO	542
CAMBIO MECÁNICO	541
COLA DE 2 PIEZAS	542
GUÍA	543

SISTEMA DE PROPULSIÓN 544

HÉLICES AL E INOX DE 3 Y 4 PALAS	544
GUÍA HÉLICES CON NÚCLEO INTEGRADO	545
HÉLICES PARA NÚCLEO INTERCAMBIABLE	547
NÚCLEO INTERCAMBIABLE	547
PIEZAS DE HÉLICE	548
ESPACIADOR	548
GUÍA KITS DE RECAMBIO	552
GUÍA RECAMBIOS DE HÉLICE	549
KIT CIERRE HÉLICE	550
PASADOR	548
TOPE HÉLICE	549
TUERCA HÉLICE	548
REF --> RO	553
RO --> REF	

JOHNSON EVINRUDE

EN FUEL & FILTRATION SYSTEM	384	TECNOSEAL	459	POWERHEAD WATER COVER GASKETS	484
CARBURATOR	396	IMPELLER GUIDE	440	REED PLATE GASKETS	486
CARBURATOR KIT - GUIDE	398	KEY	441	THROTTLE BODY TO MANIFOLD GASKETS	485
CARBURATOR - KITS	396	SEAL KIT	441	OIL SEALS	489
FLOATS	397	GEARCASE SEAL	443	UNIT DRIVES & COMPONENTS	490
NEEDLE VALVE, KIT	398	GEARCASE SEAL APPLICATION	444	EMPTY GEARCASE	493
RETAINER	398	O-RING APPLICATION	442	GEARCASE ASSY	490
VALVE KIT	398	THERMOSTAT	432	GEARCASE GUIDE	493
FUEL FILTERS AND ELEMENTS	385	COVER	436	GEAR CASE PARTS - 4 STROKES	496
BRACKET	385	CUP	438	J4, J5, J6	496
COMPLET FUEL FILTER WITH BOWL	386	DIAPHRAGM	438	J10, J15	498
FILTER KEY	388	GASKETS	436	J25	500
FUEL FILTER	390	GROMMET	436	J25, J30, J40, J50	502
FUEL FILTER - CARBURETOR	390	NIPLÉ	438	DF40, DF50	504
HIGH PRESSURE	395	PLUG WATER FLUSH	439	J/BJ 60, 70	506
IN-LINE FUEL FILTER	388	PRESSURE VALVE	437	J/BJ 90, 115, 140	507
RACOR MADE IN BRASS	388	SEAT	436	J/BJ 200, 225, 250	508
VST - FUEL FILTER	390	SLEEVE	438	GEAR CASE PARTS - 2 STROKES	509
FUEL PUMP	392	SPRING	437	4, 4.5, 5, 6, 7.5, 8	509
FUEL PUMP - ELECTRIC	393	THERMOSTAT - KIT	434	9.9, 15	510
FUEL PUMP - GASKETS & KITS	393	THERMOSTAT ASSEMBLIES	432	25, 28	511
FUEL PUMP - MECHANICAL	392	THERMOSTAT - GUIDE	439	20, 35	512
DIAPHRAGM SET	394	VALVE SEAT	438	40, 50	514
CHECK VALVE	394	WASHER	438	40, 60	516
VST - GASKETS	394	WATER PUMP	445	40, 60, 75	518
DIAPHRAGM SET APPLICATION	395	CLIP	447	V4	520
FUEL TANK COMPONENTS & CONNECTORS	384	HOUSING	445	V4/V6	524
TANK CONNECTOR	384	IMPELLER PLATE	448	V4/V6 O	526
THRU HULL	385	SLINGER	447	V4/V6 M	528
OIL	392	TUBOS AGUA DE CULATA	455	V6	530
OIL FILTER & PLUG GASKET	391	WATER PUMP - GASKET	446-449	GEARCASE SEAL KIT	541
POINTS & CONDENSERS	426	WATER PUMP - O-RING	448	ELECTRIC SHIFT	542
CONDENSERS & POINTS GUIDE	427	WATER PUMP - GUIDE	453	GEARCASE SEAL KIT APPLICATION	543
THROTTLE CABLE	430	WATER PUMP - SERVICE KIT	449	MECHANICAL SHIFT	541
WATER SEPARATING FUEL FILTER	385	ENGINE PARTS	463	TWO-PIECE GEARCASE	542
ELECTRIC SYSTEM	399	CRANKSHAFT	466	STERN DRIVE PARTS	532
CDI & POWER PACK	414	BEARING - GUIDE	470	BUSH SWIVEL	539
COILS	400	CENTER BEARING	469	CLUTCH DOGS	533
CUT OFF SWITCHES	422	CONNECTING ROD BEARING, BIG END	469	CLUTCH DOGS - GUIDE	535
IGNITION STARTER SWITCH	409	CONNECTING ROD BEARING, SMALL END	468	CLUTCH DOGS - ROD PUSH	534
REGULATOR AND RECTIFIERS	411	CONNECTING ROD	466	CLUTCH DOGS - SPRING	534
REGULATORS GUIDE	414	CRANKSHAFT GUIDE	468	COMPLETE GEAR SET	532
SENSORES CMP, IAC, MAT/MAP	399	CYLINDER GASKET	466	DIABOLO	540
SOLENOID RELAY	409	LOWER BEARING	470	DRAIN WATER TUBE	540
RELAY - TRIM	410	UPPER BEARING	469	DRAIN, SCREW AND GASKETS	540
SPARK PLUG	401	OIL SEALS SETS	467	INITIATIVE GEAR	533
EVINRUDE	403	ENGINE PARTS - 4 STROKES	463	LOWER DRIVE SHAFT	537
JOHNSON	401	ENGINE GASKETS - 4 STROKES	464	LOWER HOUSING BEARING GUIDE	536
HD SPARK PLUG WIRE SET	404	CYLINDER COVER	465	OIL PUMP - BEARING	539
SPARK PLUG PIPE	405	CYLINDER GASKET	465	POSITIVE GEAR	532
STARTERS	405	CYLINDER HEAD GASKET	464	PROP SHAFT	538
GUIDE	408	CYLINDER HEAD GASKET - KIT	465	REVERSE GEAR	532
REWIND SPRING	408	GASKET, PRESSURE VALVE	466	SHIFT, BELOW	539
STARTER PAWL SPRING	408	GASKET, THROTTLE BODY	466	SHIFT, O-RING	539
STARTER PAWL	409	GASKET, UPPER SEAL	466	TURNBUCKE, CUTCH ROD	539
STARTOR	418	THERMOSTAT COVER	465	UPPER DRIVE SHAFT	538
GUIDE - POWER PACK, STARTOR, TRIGGER	420	ENGINE GASKETS - 2 STROKES	475	WATER PUMP - BEARING	541
TRIGGER	417	CYLINDER GASKET	480	TOOLS	494
TRIM, TILT & POWER TRIM	423	CYLINDER HEAD GASKET	475	BEARING CARRIER RETAINER WRENCH	494
COMPLETE TRIM ASSEMBLY	423	CYLINDER HEAD GASKET - GUIDE	479	FLYWHEEL PULLER	495
PLUG PISTON TRIM	426	CYLINDER HEAD GASKET - KIT	477	GEAR CASE TOOL KIT	494
POWER TRIM ASSEMBLY	425	GUIDE TIMING BELT	481	PINION NUT ADAPTOR KIT	495
TRIM PLUGS EXTRACTOR	426	PISTONS	472	PROP AND BEARING PULLER	494
TRIM SENSOR	425	EXHAUST & INTAKE SYSTEM	482	PROP WRENCH KIT	495
WIRING HARNESS	423	EXHAUST SYSTEM	482	UNIVERSAL PULLER PLATE	494
STEERING SYSTEM	428	EXHAUST SYSTEM - INTERMEDIATE HOUSING	483	POPULSION SYSTEM	544
ENGINE CONTROLS	428	EXHAUST SYSTEM - GASKETS	482	3 & 4 BLADE ALUMINIUM & SS PROPELLERS	544
CONSOLE CONTROL	429	OIL PAN GASKET	484	INTERCHANGEABLE HUB	547
SIDE CONTROL	428	SEALS - HOUSING EXHAUST	483	PROPELLERS APPLICATION WITH RUBBER HUB	545
SWITCHES & CABLES	429	INTAKE SYSTEM	484	PROPELLERS FOR INTERCHANGEABLE HUB	547
ARNES	430	AIR SILENCER GALLERY	488	PROP PARTS	548
ARNES EXTENSION	430	CARBURETOR TO INTAKE GASKETS	485	PROPELLER - WASHER	548
CONTROL CABLE	430	GALLERY	486	PROPELLER KITS & HARDWARE GUIDE	552
CONTROL SWITCH	429	GASKET OIL PUMP	487	PROPELLER NUT	548
COOLING SYSTEM	431	GASKET TIMING CHAIN GUIDE BASE	487	PROPELLER NUT - KITS	550
ANODE	455	GASKET, COLLECTOR	486	PROPELLER SPARE PARTS	549
CANADA METAL	455	GASKET, MOUNT OIL SEAL COVER	487	THRUST WASHER	549
RECMAR	458	INTAKE TO CARBURETOR GASKETS	485	REF --> RO	553
		POWERHEAD TRANSFER GASKET	485	RO --> REF	

SISTEMA DI ALIMENTAZIONE E FILTRAZIONE	384	KIT TENUTE	441	GUARNIZIONE SCARICO ED INTERMEDIE	483
CAVO ACCELERATORE	430	GUIDA TENUTE PIEDE	444	PARAOILIO SCARICO	483
CARBURATORE	396	O-RING	442	UNITA DI TRASMISSIONE	490
CARBURATORE - GUIDA KIT	398	TENUTE PIEDE	443	CARCASSA	493
CARBURATORE - KIT	396	LIQUIDO INIBITORE DELLA CORROSIONE	431	GUIDA PIEDE	493
CARBURATORE COMPLETO	396	POMPA ACQUA	445	PIEDI	490
FERMO	398	POMPA ACQUA - CORPO	445	ATTREZZI	494
GALLEGGIANTE	397	GUARNIZIONE - BASE POMPA	446	CHIAVE DADO ASSE VERTICALE	495
KIT DE VALVOLA	398	BOCCOLA	447	CHIAVE PER CUSCINETTO	494
KIT SPILLO CONICO	398	CLIP	447	ESTRATTORE CUSCINETTI E ELICA	494
COMPONENTI SERBATOIO E CONETTORI	384	GUARNIZIONE	448	ESTRATTORE PIGNONE	494
ATTACCO SERBATOIO	384	PIASTRA GIRANTE	448	ESTRATTORE VOLANO	495
PASSASCAFFO	385	GUARNIZIONE - POMPA	449	KIT ATTEZZI PIEDI	494
FILTRI BENZINA E RACCORDI	385	KIT RICAMBI POMPA ACQUA	449	KIT CHIAVE ELICHA	495
CHIAVE DA FILTRO	388	POMPA ACQUA - GUIDA	453	PARTI PIEDE	532
FILTRO BENZINA - CARBURATORE	390	KIT TUBI ACQUA TESTATA	455	ALBERO TRANS. INFERIORE - CUSCINETTO	537
FILTRO BENZINA ALTA PRESSIONE	390	TERMOSTATO	432	ALBERO TRANS. SUPERIORE - CUSCINETTO	538
FILTRO BENZINA PER MONTARE IN LINEA	388	ESPLOSO TERMOSTATO	432	ASSE ELICA	538
FILTRO BENZINA VST BASSA PRESSIONE	390	TERMOSTATO	433	ASSE TRASMISSIONE INFERIORE	537
FILTRO DI DECANTAZIONE BENZINA CON VASCHETTA TRASPARENTE	386	TERMOSTATO - KIT	434	ASSE TRASMISSIONE SUPERIORE	538
FILTRO SEPARATORE ACQUA-BENZINA	385	SEDE DI TERMOSTATO	436	ASTA PRESSIONE	534
RACCORDO IN OTTONE	388	TERMOSTATO - COPERCHIO	436	DADO ASTA CAMBIO	539
SUPPORTO	385	SPESSORE	436	DIABOLO	540
FILTRO OLIO	391	TERMOSTATO - GUARNIZIONI	436	DIABOLO - CUSCINETTO	540
GUARNIZIONE TAPPO	391	GUARNIZIONE COPERCHIO REFRIGERAZIONE	437	GUIDA CUSCINETTI PIEDE	536
INNITTORE	395	MOLLA	437	KIT PIGNONI COMPLETO	532
OLIO	392	TENUTA MOLLA	437	MANICOTTO MARCE	539
POMPA BENZINA	392	VALVOLA ANTI-PRESSIONE DE TERMOSTATO	437	O-RING DIAVOLO	540
POMPA BENZINA MECCANICA	392	RONDELLA	438	O-RING MARCE	539
POMPA BENZINA ELETTRICA	393	SEDE DI VALVOLA	438	PIGNONI INIZIATIVA	533
GUARNIZIONI	393	TERMOSTATO - MANICOTTO	438	PIGNONI MARCIA AVANTI	532
POMPA BENZINA- KIT	393	MEMBRANA	438	PIGNONI MARCIA INDIETRO	532
KIT MEMBRANA	394	NIPLI	438	POMPA ACQUA	541
VALVOLA	394	COPERCHIO	438	POMPA OLIO	539
GUARNIZIONE VST	394	GUIDA	439	RONDELLA PIGNONI INIZIATIVA	533
GUIDA MEMBRANA	395	KIT TAPPO	439	SELETTORE	533
PUNTINE E CONDENSATORE	426	PARTI MOTORE	463	SELETTORE - GUIDA	535
GUIDA E KIT	427	ALBERO MOTORE	466	SELETTORE - MOLLA	534
SISTEMA ELETTRICO	399	BIELLA	466	SELETTORE - PIN	534
BOBINE	400	CUSCINETTO - GUIDA	470	SPESSORE PIGNONI INIZIATIVA	533
CANDELE	401	CUSCINETTO CENTRALI	469	SPINOTTO	534
EVINRUDE	403	CUSCINETTO DI BIELLA, FINALE GRANDE	469	TUBO DRENAGGIO ACQUA	540
JOHNSON	401	CUSCINETTO DI BIELLA, FINALE PICCOLO	468	VITI E GUARNIZIONE, DRENAGGIO	540
KIT CAVI CANDELE, ALTE PRESTAZIONI	404	CUSCINETTO INFERIORE	470	PARTI PIEDI DE 4 TEMPI	496
GOMITO PER CANDELE	405	CUSCINETTO SUPERIORE	469	J4, J5, J6	496
CDI E CENTRALINA	414	PARAOILIO	467	J10, J15	498
CHIAVETTA DI SICUREZZA	422	PARAOILIO - GUIDA	468	J25	500
CHIAVI DI ACCENSIONE	409	PARAOILIO - KIT	467	J25, J30, J40, J50	502
MOTORINI AVVIAMENTO	405	CINGHIE DISTRIBUZIONE	481	DF40, DF50	504
MOLLE AVVIAMENTO	408	GUARNIZIONI DE MOTORE 4 TEMPI	464	J/BJ 60, 70	506
MOLLE DI SICUREZZA AVVIAMENTO	408	GUARNIZIONE BASE MOTORE	465	J/BJ 90, 115, 140	507
PIASTRA AVVIAMENTO MANUALE	409	GUARNIZIONE COPERCHIO PUNTERIE	465	J/BJ 200, 225, 250	508
REGOLATORI E RADDRIZZATORI	411	GUARNIZIONE COPERCHIO TERMOSTATO	465	PARTI PIEDI DE 2 TEMPI	509
GUIDA	414	GUARNIZIONE CORPO FARFALLATO	466	4, 4.5, 5, 6, 7.5, 8	509
SENSORE	399	GUARNIZIONE DE TESTATA	464	9.9, 15	510
SENSORE CMP	399	GUARNIZIONE PARAOLIO SUPERIORE	466	25, 28	511
SENSORE IAC	399	GUARNIZIONE TESTATA - KIT	465	20, 35	512
SENSORE MAT/MAP	399	GUARNIZIONE VALVOLA PRESSIONE	466	40, 50	514
SOLENOIDE RELE	409	GUARNIZIONI MOTORE 2 TEMPI	475	40, 60	516
RELE TRIM	410	GUARNIZIONE BASE MOTORE	480	40, 60, 75	518
STARTOR	418	GUARNIZIONE DE TESTATA	475	V4	520
GUIDA CENTRALINA, STARTOR, TRIGGER	420	GUARNIZIONE TESTATA - GUIDA	479	V4/V6	524
TRIGGER	417	GUARNIZIONE TESTATA - KIT	477	V4/V6 O	526
TRIM, TILT & POWER TRIM	423	PARTI MOTORI 4 TEMPI	463	V4/V6 M	528
ESTRATTORE PER TAPPI DI TRIM	426	J/BJ 40, 50 HP	463	V6	530
INSTALLAZIONE ELETTRICA	423	PISTONI	472	KIT RIPARAZIONE PIEDE	541
MOTORINO TRIM COMPLETO	423	KIT PISTONE	473	CAMBIO MECCANICO	541
POWER TRIM COMPLETO	425	SISTEMA DI SCARICO E ASPIRAZIONE	482	CAMBIO ELETTRICO	542
TAPPO PISTONE TRIM	425	SISTEMA ASPIRAZIONE	484	PIEDE 2 PEZZI	542
TRIM - SENSORE	425	GUARNIZIONE ASPIRAZIONE - CARBURATORE	485	GUIDA KIT RIPARAZIONE PIEDE	543
SISTEMA DI GUIDA	428	GUARNIZIONE BASE PARAOLIO	487	SISTEMA DI PROPULSIONE	544
COMANDI DI CONTROLLO	428	GUARNIZIONE CARTER CATENA	487	ELICHE ALLUMINIO E INOX DA 3 E 4 PALE	544
COMANDO LATERALE	428	GUARNIZIONE COLLETORE	486	ELICHE PER MOZZO INTERCAMBIABILE	547
COMANDO PER CONSOLLA	429	GUARNIZIONE COPERTORE	486	GUIDE ELICHE CON MOZZO	545
INTERRUTTORI E CAVI	429	GUARNIZIONE COPERTORE CROSSFLOW	485	MOZZO INTERCAMBIABILE	547
CAVI	430	GUARNIZIONE COPERCHIO PASSAGGIO ACQUA	484	PARTI ELICA	548
CAVI COMANDO	430	GUARNIZIONE CORPO FARFALLA COLLETORE	485	DADO DI ELICA	548
ESTENSIONE	430	GUARNIZIONE INTERMEDIA CARBURATORE - COLLETORE	485	DISTANZIALE ELICA	548
INTERRUTTORI CONTROLLO	429	GUARNIZIONE MARMITA	488	GUIDA RICAMBI CHIUSURA ELICHE	552
SISTEMA DI RAFFREDDAMENTO	431	GUARNIZIONE PIASTRA	486	GUIDA RICAMBIO ELICHE	549
ANODI	455	GUARNIZIONE PIASTRA	486	KIT CHIUSURA ELICA	550
CANADA METAL	455	GUARNIZIONE POMPA D'OLIO	487	RONDELLA CHIUSURA	549
RECMAR	458	PARAOILIO	489	SPINOTTO	548
TECNOSEAL	459	GUARNIZIONE TAPPO DRENAGGIO	489	REF --> RO	553
GUIDA GIRANTE	440	SISTEMA SCARICO	482	RO --> REF	
CHIAVETTA	441	GUARNIZIONE COPPA OLIO	484		
		GUARNIZIONE SCARICO	482		

SYSTÈME D'ALIMENTATION ET DE FILTRATION

HUILES	392
CÂBLES D'ACCELERATION	430
POMPE À ESSENCE	392
POMPE À ESSENCE MECANIQUE	392
POMPE À ESSENCE ELECTRIQUE	393
POMPE À ESSENCE - JOINTS	393
KIT POMPE ESSENCE	393
KIT DIAPHRAGME	394
SOUPAPE	394
JOINTS VST	394
GUIDE DIAPHRAGME	395
CARBURATEUR	396
CARBURATEUR - GUIDE KITS	398
CARBURATEUR - KIT	396
CARBURATEUR COMPLET	396
FLOTTEUR	397
KIT SIEGE, POINTEAU ET GICLEUR	398
KIT SOUPAPE	398
RETENUE	398
COMPOSANTS ET CONNECTEURS DU RESERVOIR	384
PASSE-CLOISON	385
RACCORDS DE RESERVOIR	384
FILTRE A HUILE	391
JOINT DE VIDANGE	391
FILTRE À ESSENCE ET CARTOUCHE DE RECHANGE	385
CLÉ À FILTRE	388
FILTRE À ESSENCE BASSE PRESSION	390
FILTRE À ESSENCE HAUTE PRESSION	390
FILTRE À ESSENCE DE CARBURATEUR	390
FILTRE À ESSENCE EN LIGNE	388
FILTRE SÉPARATEUR EAU-ESSENCE	385
FILTRE SÉPARATEUR EAU-ESSENCE AVEC BOL TRANSPARENT	386
RACCORD EN LAITON	388
TÊTE DE FILTRE À ESSENCE	385
INJECTEURS	395
VIS PLATINEES ET CONDENSATEUR	426
GUIDE ET KITS	427
SYSTÈME ÉLECTRIQUE	399
BOBINES	400
BOUGIES	401
EVINRUDE	403
JOHNSON	401
CAPUCHON DE BOUGIE	405
KIT FAISCEAU DE BOUGIE	404
CDI ET BOITIER ELECTRONIQUE	414
COUPE CIRCUIT DE SÉCURITÉ	422
CONTACTEUR À CLÉ	409
DEMARRER	405
CLIQUET D'ARRÊT DU LANCEUR MANUEL	409
GUIDE RESSORT DE DÉMARRAGE	408
RESSORT DE DÉMARRAGE	408
RESSORT DE SÉCURITÉ DÉMARRAGE	408
REGULATEURS ET RECTIFIEURS	411
GUIDE REGULATEUR	414
SONDE IAT/ IAC/ CMP	399
CAPTEUR MAP/MAT	399
SOLENOÏDE RELAIS	409
TRIM	410
STARTOR	418
GUIDE BOITIER ELECTRONIQUE, STARTOR, TRIGGER	420
TRIGGER	417
TRIM, TILT & POWER TRIM	423
BOUCHON VERIN DE TRIM	426
INSTALLATION ELECTRIQUE	423
KIT EXTRACTEUR	426
MOTEUR DE TRIM COMPLET	423
POWER TRIM COMPLET	425
SONDE DE TRIM	425
SYSTÈME DE DIRECTION	428
INTERRUPTEUR ET CÂBLES	429
CÂBLES DE COMMANDE	430
FAISCEAU ELECTRIQUE	430
INTERRUPTEUR DE CONTRÔLE	429
RALLONGE FAISCEAU	430
BOITIER DE COMMANDE	428
BOITIER LATERAL	428
BOITIER POUR CONSOLE	429
SYSTÈME DE REFROIDISSEMENT	431
ANODES	455
CANADA METAL	455
RECMAR	458
TECNOSEAL	459

POMPE À EAU	445
CLIPS	447
INSERT	447
JOINT DE BASE DE POMPE À EAU	446
KIT REPARATION	449
PLAQUE DE TURBINE	448
POMPE À EAU - CORPS	445
POMPE À EAU - JOINT TORIQUE	448
POMPE À EAU - GUIDE	453
POMPE À EAU - JOINT	449
TUYAU D'EAU DE CULASSE	455
GUIDE TURBINES	440
CLAVETTE	441
KITS JOINTS	441
JOINT TORIQUE	442
JOINTS	443
GUIDE DES JOINTS	444
SALT OFF	431
THERMOSTAT	432
BAGUE	436
COUPELLE DE RESSORT	437
COUVERCLE	436
COUVERCLE	438
DIAPHRAGME	438
GUIDE	439
JOINT DE PLAQUE DE REFROIDISSEMENT	437
JOINT DE THERMOSTAT	436
JOINT DE VALVE	438
KIT BOUCHON	439
KIT THERMOSTAT	434
LOGEMENT	438
PIÈCES DE THERMOSTAT	432
RESSORT	437
RONDELLE	438
SOUPAPE DE PRESSION DE THERMOSTAT	437
TETINE	438
THERMOSTAT	433
PIECES MOTEUR	463
VILEBREQUIN	466
BIELLE	466
GUIDE ROULEMENT	470
JOINT SPI	467
JOINT SPI - GUIDE	468
JOINT SPI - KIT	467
ROULEMENT CENTRAL	469
ROULEMENT INFÉRIEUR	470
ROULEMENT PIED DE BIELLE	468
ROULEMENT SUPÉRIEUR	469
ROULEMENT TÊTE DE BIELLE	469
PIECES MOTEURS 4 TEMPS	463
GUIDE DES COURROIES DE DISTRIBUTION	481
JOINTS DE MOTEUR 4 TEMPS	464
JOINT DE CACHE CULBUTEUR	465
JOINT DE THROTTLE BODY	466
JOINT LOGEMENT THERMOSTAT	465
JOINT SOUPAPE DE PRESSION	466
JOINT SPI SUPÉRIEUR	466
JOINTS DE CULASSE	464
JOINTS DE CULASSE - KIT	465
JOINTS DE TÊTE MOTRICE	465
JOINTS DE MOTEUR 2 TEMPS	475
JOINT DE CULASSE	475
JOINT DE CULASSE - GUIDE	479
JOINT DE CULASSE - KIT	477
JOINT DE TÊTE MOTRICE	480
PISTONS	472
PISTONS - KIT	473
SYSTÈME D'ÉCHAPPEMENT ET D'ADMISSION	482
SYSTÈME D'ADMISSION	484
JOINT CORPS DE PAPILLON POUR COLLECTEUR	485
JOINT DE COLLECTEUR	486
JOINT DE COUVERCLE D'HUILE	487
JOINT DE COUVERCLE DE TRANSFERT POUR MOTEURS CROSSFLOW	485
JOINT DE PLAQUE	486
JOINT DU CARBURATEUR AU COLLECTEUR D'ADMISSION	485
JOINT DU CARTER D'ADMISSION AU CARBURATEUR	485
JOINT DU GUIDE DE DISTRIBUTION	487
JOINT DU SILENCIEU	488
JOINT POMPE D'HUILE	487
JOINTS DE COUVERCLE DU PASSAGE D'EAU	484
SYSTÈME D'ÉCHAPPEMENT	482
JOINT D'ÉCHAPPEMENT	482
JOINT D'ÉCHAP. DU CORPS INTERMÉDIAIRE	483
JOINT DE CARTER D'HUILE	484
JOINT DU COUVERCLE D'ÉCHAPPEMENT	483

JOINT SPI	489
JOINT DE VIDANGE	489
EMBASES ET PIÈCES	490
CARTER	493
EMBASE	490
GUIDE D'EMBASES	493
OUTILS	494
CLE POUR ARBRE VERTICAL	495
CLE POUR ECROU D'HELICE	495
CLE POUR ECROU DE DIABOLO	494
EXTRACTEUR DE ROULEMENTS D'HELICE	494
EXTRACTEUR DE VOLANT MOTEUR	495
EXTRACTEUR PIGNONS ET ROULEMENTS	494
KIT OUTILS POUR EMBASES	494
KIT REPARATION EMBASE	541
CARTER EN DEUX PARTIES	542
CHANGEMENT DE VITESSE ELECTRIQUE	542
CHANGEMENT DE VITESSE MECANIQUE	541
GUIDE KIT REPARATION	543
PIÈCES D'EMBASES DE 4 TEMPS	496
J4, J5, J6	496
J10, J15	498
J25	500
J25, J30, J40, J50	502
DF40, DF50	504
J/BJ 60, 70	506
J/BJ 90, 115, 140	507
J/BJ 200, 225, 250	508
PIECES D'EMBASES DE 2 TEMPS	509
4, 4.5, 5, 6, 7.5, 8	509
9.9, 15	510
25, 28	511
20, 35	512
40, 50	514
40, 60	516
40, 60, 75	518
V4	520
V4/V6	524
V4/V6 0	526
V4/V6 M	528
V6	530
PIECES D'EMBASES	532
ARBRE D'HELICE	538
ARBRE DE TRANSMISSION INFÉRIEUR	537
ARBRE DE TRANSMISSION INFÉRIEUR - ROULEMENT	537
ARBRE DE TRANSMISSION SUPÉRIEUR	538
ARBRE DE TRANSMISSION SUPÉRIEUR - ROULEMENT	538
BAGUE TOURNANTE	539
CRABOT	533
CRABOT - GUIDE	535
CRABOT - PIVOT	534
CRABOT - TIGE DE POUSSEE	534
DIABOLO	540
DIABOLO - JOINT TORIQUE	540
DIABOLO - ROULEMENT	540
KIT PIGNONS COMPLET	532
LEVIER - JOINT TORIQUE	539
LEVIER - SOUFFLET	539
LEVIER - ECROU	539
PIGNON D'ATTAQUE	533
PIGNON D'ATTAQUE - CALE	533
PIGNON D'ATTAQUE - RONDELLE	533
PIGNON MARCHE ARRIÈRE	532
PIGNON MARCHE AVANT	532
RESSORT DE SELECTEUR	534
ROULEMENT D'EMBASE - GUIDE	536
ROULEMENT DE POMPE À EAU	541
ROULEMENT DE POMPE À HUILE	539
TUBE DE VIDANGE DE LA POMPE À EAU	540
VIS ET JOINTS DE VIDANGE	540
SYSTÈME DE PROPULSION	544
HÉLICE ALUMINIUM ET INOX 3 ET 4 PALES	544
GUIDE DES HÉLICES ET MOYEURS	545
HÉLICES AVEC MOYEU INTERCHANGEABLE	547
MOYEU INTERCHANGEABLE	547
PIÈCES POUR HÉLICE	548
ÉCROU D'HELICE	548
ÉCROU D'HELICE - KIT	550
ENTRETOISE D'HELICE	548
GOUPILLE FENDUE	548
GUIDE DES KITS ET PIÈCES POUR HÉLICE	552
GUIDE DES PIÈCES POUR HÉLICE	549
RONDELLE DE BUTÉE	549
REF --> RO	553
RO --> REF	

SISTEMA DE ALIMENTACIÓN Y FILTRACIÓN FUEL & FILTRATION SYSTEM

SISTEMA DI ALIMENTAZIONE E FILTRAZIONE SYSTÈME D'ALIMENTATION ET DE FILTRATION

COMPONENTES TANQUE Y CONECTORES

FUEL TANK COMPONENTS & CONNECTORS

COMPONENTI SERBATOIO E CONETTORI

COMPOSANTS ET CONNECTEURS DU RESERVOIR

CONECTOR DE DEPÓSITO

TANK CONNECTOR

ATTACCO SERBATOIO

RACCORDS DE RESERVOIR

Fabricado en latón.

Made in machined brass.

Fabbricato in ottone.

Fait en laiton.

REF	1/4" NPT	1
GS31068		



Para conectar dos motores a un sólo depósito, o viceversa.
Fabricado en latón.

To connect two motors to a single tank, or vice versa.
Made in machined brass

Per collegare due motori a un singolo serbatoio o viceversa.
Fabbricato in ottone.

Pour connecter deux moteurs à un même réservoir, ou inversement.
Fait en laiton.

REF	1/4" NPT	1
GS31069		



Toma de tanque de combustible.
Fabricado en latón.

Fuel tank connector
Made in machined brass

Filettatura per serbatoio benzina
Fabbricato in ottone.

Prise de réservoir de carburant.
Fait en laiton.

REF	OEM	1/4" NPT	1
GS31021			
GS31083	772681	1/4" NPT	1



GS31021

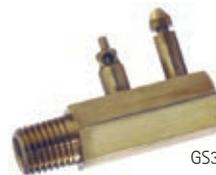

GS31083



CONECTOR DOBLE

DOUBLE CONNECTOR

CONNETTORE DOPPIO

CONNECTEUR DOUBLE

REF	8 mm	1
GS31092		



REF	OEM	COMPATIBLE	3/8"	5/16"	2T STROKES	4T STROKES
GS31089	5032150	REC65720-986LO	1	1		
GS31084	174508	GS31083	1	1		25 - 140 hp
GS31085	176445	GS31083	1			
	0775641					
GS31035	5033222		1	1	60 hp	
GS31036	5033222		1			



GS31089, GS31084, GS31085



GS31035-GS31036



REF	OEM	10, 15 HP (2003-05)
REC65720-98520	5033221	



new

REF	OEM	6 - 200 HP	3/8"
REC65720-986LO	5032150		



new

PASAMAMPAROS

THRU HULL

PASSASCAFO

PASSE-CLOISON

Para atravesar mamparos de hasta 12 mm. Fabricado en latón.

For bulkhead up to 12 mm. Made in machined brass.

Per attraversare paratie fino a 12 mm. Fabricato in ottone.

Pour traverser des cloisons jusqu'à 12 mm. Fait en laiton.

REF		
GS31064	3/8"	1



FILTRO DE COMBUSTIBLE Y ELEMENTOS

FUEL FILTERS AND ELEMENTS

FILTRI BENZINA E RACCORDI

FILTRE A ESSENCE ET CARTOUCHE DE RECHANGE

BRACKET

BRACKET

SUPPORTO

TÊTE DE FILTRE À ESSENCE

Con 2 tapones de bronce y 2 tubos de extensión. (2 entradas y 2 salidas).

With 2 brass plugs and 2 extension tubes. (2 inputs & 2 outputs).

Con 2 tappi di bronzo e 2 tubi di estensione. (2 ingressi entrata carburante e 2 uscite carburante).

Avec 2 bouchons en bronze et 2 tubes d'extension. (2 entrées et 2 sorties).

REF	R.O. OEM		
REC25000	89876A3	1/4"	AL
REC25010		1/4"	INOX /SS AISI316
REC25020		3/8"	AL
REC25030		3/8"	INOX /SS AISI316
RECOBBRACKET		1/4"	Plástico Plastic Plastica Plastique



REC25000 - REC25020



REC25010 - REC25030



RECOBBRACKET

FILTRO COMBUSTIBLE SEPARADOR DE AGUA

WATER SEPARATING FUEL FILTER

FILTRO SEPARATORE ACQUA-BENZINA

FILTRE SÉPARATEUR EAU-ESSENCE

REF	MICRON	
REC24942	10	4 7/16" = 11 cm
REC35-802893Q01	10	3 3/4"
REC855686	28	4 7/16"
REC35-802893Q	25	3 3/4"
RACPF5510	10	4 7/16"

RACOR



RACPF5510

RECMAR



REC24942



REC35-802893Q01



REC855686



REC35-802893Q

Filtro original.

OEM filter.

Filtro benzina originale.

Filtre à essence original

REF	R.O. OEM	MICRON	
RM35-802893Q	35-802893Q01	10	3 3/4"



FILTRO CON BRACKET

Con 2 tapones de bronce y 1 tubo de extensión.

OEM FILTER WITH BRACKET

With 2 brass plugs & 1 extension tube.

FILTRO BENZINA CON SUPPORTO

Con 2 tappi di bronzo e 1 tubo di estensione.

FILTRE A ESSENCE AVEC SUPPORT

avec 2 bouchons en bronze et 1 tube d'extension

REF	MICRON			BRACKET
REC24950	25	1/4"	50 GPH	AL
REC24952	10	1/4"	50 GPH	AL



RECMAR

FILTRO DECANTADOR DE COMBUSTIBLE COMPLETO CON VASO TRANSPARENTE

COMPLET FUEL FILTER WITH TRANSPARENT BOWL

FILTRO DI DECANTAZIONE BENZINA COMPLETO CON VASCHETTA TRASPARENTE

FILTRE SÉPARATEUR EAU-ESSENCE AVEC BOL TRANSPARENT

REF	OEM		BRACKET	
RAC320R-RAC-01			AL	F75-150 HP
RAC320R-RAC-03	8M0097838	RACS3213 LENS3213	Plástico Plastic Plastica Plastique	SeaPro (2014-)



REF			BRACKET
RECOBFILALU			AL
RECOBFILTER	RECOBELEMENT LENS3213	150 l/h	Plástico Plastic Plastica Plastique



REF		MICRON		
REC90794-46866	REC90794-46868	10	117 l/h	175 hp



LLAVE PARA FILTRO
FILTER KEY
CHIAVE DA FILTRO
CLÉ A FILTRE

REF
RECYS-225-15



REF	MICRON	
PAF40-0701000EI	10	70 hp



REF		MICRON		
RAC120R-RAC-01	RACS3240 LENS3227	10	114 l/h	50 - 115 hp



FILTRO DECANTADOR GASOLINA

COMPLETE FUEL FILTER

FILTRO DECANTATORE BENZINA

FILTRE DÉCANTEUR POUR ESSENCE

RACOR



	RAC120R-RAC-01	RAC320R-RAC-01	RAC320R-INOX-01	RAC320R-RAC-02
	114 l/h 30 gph	340 l/h 60 gph	340 l/h 60 gph	340 l/h 60 gph
	RACS3240	RACS3213	RACS3213	RACS3220UL
CAZOLETA TRANSPARENTE (sólo se recomienda para fueraborda.) CLEAR BOWL (Just for outboards) VASCHETTA TRASPARENTE (Solo nei fuoribordo.) BOL TRANSPARENT (Uniquement recommandé pour les hors-bord.)	✓	✓	✓	✗
ROSCAS CENTRALES CENTRAL THREADS FILETTO CENTRALE FILETAGES CENTRAUX	M18 x 1.5	1 1/4"	1 1/4"	1 1/4"
TAMAÑO ROSCA CABEZA HEAD PORT SIZE DIMENSIONE VITE TESTA TAILLE DU FILETAGE DE TÊTE	1/4-18 NPTF	1/4-18 NPTF	1/4-18 NPTF	1/4-18 NPTF
X Ø	166 x 81 mm	238 x 102 mm	238 x 102 mm	238 x 102 mm
	0,5 kg	0,9 kg	0,9 kg	0,9 kg
CAIDA DE PRESIÓN PRESSURE DROP CADUTA DI PRESSIONE CHUTE DE PRESSION	0.15 PSI 0.01 bar	0.61 PSI 0.04 bar	0.61 PSI 0.04 bar	0.61 PSI 0.04 bar
MAX	7 PSI 0.05 bar	7 PSI 0.05 bar	7 PSI 0.05 bar	7 PSI 0.05 bar
DESMONTAJE CARTUCHO-CAZOLETA ELEMENT REMOVAL UNDERBOWL RIMOZIONE DELLA CARTUCCIA DEMONTAGE DE LA CARTOUCHE	25,4 mm 1"	25,4 mm 1"	25,4 mm 1"	25,4 mm 1"
	-40°C +124°C			

ELEMENTOS DE RECAMBIO

ELEMENT

ELEMENTI DI RICAMBIO

CARTOUCHE DE RECHANGE

REF	FILTRO FILTER FILTRO FILTRE
RACS3240	RAC120R-RAC-01
LENS3240	
RACS3227	Yamaha-Suzuki
LENS3227	
RACS3213	RAC320R-RAC-01
RACS3213	RAC320R-RAC-01 INOX
LENS3213	RAC320R-RAC-03
RACS3214	Johnson & Evinrude
RACS3228UL	RAC320R-RAC-02, (bracket RACOR)

LENS3240
LENS3227
LENS3214



RACS3240
RACS3227
RACS3214



RACS3228UL

FILTRO CON BOMBA CEBADORA

FILTER WITH PRIMMING PUMP

FILTRO CON PEMPETA PER RIEMPIRE

FILTRE ESSENCE AVEC POMPE D'AMORCAGE



REF	R.O. OEM		MICRON			
RAC490R-RAC-01	8M0097838	RACS3227 LENS3227	10	340 l/h	3/8" NPTF	150 hp



RACOR

JOHNSON EVINRUDE

RECAMBIOS MARINOS

Filtro de combustible con braket.

Complete fuel filter with braket.

Filtro combustibile con supporto.

Filter à carburant avec support.

REF		
RAC23299-10	RAC23289-10	130 HP (4 T/ Strokes)

RACOR.



LLAVES PARA FILTRO

FILTER KEY

CHIAVE DA FILTRO

CLÉ À FILTRE

REF
RACRK22628

RACOR.



REF	65 - 110 mm
REC70720	

RECMAR

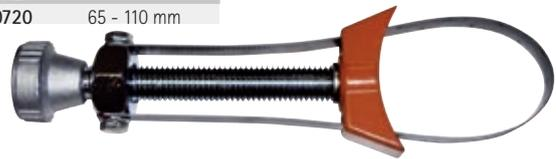

RACOR DE LATÓN

RACOR MADE IN BRASS

RACCORDO IN OTTONE

RACCORD EN LAITON

REF			
GS31065	1/4" NPT	3/8" = 9.5 mm	1
GS31166	1/4" NPT	5/16" = 7.9 mm	2
GS31155	3/8" NPT	3/8" = 9.5 mm	2
GS31156	3/8" NPT	5/16" = 7.9 mm	2
GS31157	3/8" NPT	1/4" = 6.4 mm	2



REF	R.O. OEM			
GS31066	22-8977102	1/4" NPT	5/16" = 7.9 mm	2
GS31067	22-34982	1/4" NPT	3/8" = 9.5 mm	2

GOLDENSHIP



FILTRO COMBUSTIBLE PARA MONTAJE EN LINEA

IN-LINE FUEL FILTER

FILTRO BENZINA PER MONTARE IN LINEA

FILTRE A ESSENCE EN LIGNE

REF					GOLDENSHIP
GS31001	50 l/h	6-8 mm	plástico plastic plastique	1	
GS31002	150 l/h	8-10 mm	plástico plastic plastique	1	



GS31001



GS31002

REF	OEM			
REC40145	0354016	1/4"	1/4"	plástico plastic plastique
REC40155		5/16"	5/16"	
REC40165		3/8"	3/8"	
REC40135	398327 398319	5/16"	3/8"	plástico plastic plastique



REF			
GS30435	6, 8, 10 mm	metal + cristal metal + crystal metallo + cristallo métal + cristal	1



GOLDENSHIP

REF	OEM		2T STROKES	4T STROKES
REC15410-87J30	5035974	J/ BJ25 HP BJ60, BJ70 HP J/ BJ90 HP J/ BJ115 HP J/ BJ140 HP (2005+)		✓



REF	OEM		2T STROKES	4T STROKES
REC15410-98500	5032238		✓	✓

E40, E50, E70
J4, J5, J6, J10, J15, J40, J50, J60, J70
BJ40, BJ50, BJ60, BJ70
(2000+)



REF	OEM		E-TEC 40, 50, 60, 75, 90, 115, 150, 175, 200 DPL	2T STROKES	4T STROKES
REC5007335	5007326 5005266	3/8"		✓	



REF	OEM		2T STROKES	4T STROKES	new
REC15410-93J00	5034984		✓		

200-225 HP
V6



REF	OEM		4 Et6 HP (1 CYL) (2012-15) 9.8 HP (2 CYL) (2012-15) 15 HP (2CYL) (2012-14)	2T STROKES	4T STROKES	new
PAF4-05000300	5040140			✓	✓	



REF	OEM		E25, E30, E40, E50, E70 J30, J40, J50, J60, J70, J90, J115, J140 BJ40, BJ50, BJ60, BJ70, BJ90, BJ115, BJ140 (2000+)
REC15410-87J10	5032323 5030702		



REF	OEM		E5RECS (1998-01) E5RLECS (1998-01)	2T STROKES	4T STROKES	new
REC16910-GB2-005	5030183			✓		



REF	OEM		60° V4 Et V6 (1991-06)
REC433190	433190 765553		



REF	OEM		200-225 HP V6	2T STROKES	4T STROKES	new
REC65L-24563-00	5035695 0778162			✓	✓	



KIT FILTRO COMBUSTIBILE FUEL FILTER KIT KIT FILTRO BENZINA KIT FILTRE A ESSENCE

REF	OEM
REC35-49088A2	312456
REC981911	981911



REC35-49088A2 REC981911

ELEMENTO FILTRO COMBUSTIBILE FUEL FILTER ELEMENT CARTICIA FILTRO BENZINA ELEMENT FILTRE A ESSENCE

REF	OEM
REC982230	982230



FILTRO COMBUSTIBLE - CARBURADOR

FUEL FILTER - CARBURETOR

FILTRO BENZINA - CARBURATORE

FILTRE A ESSENCE DE CARBURATEUR

REF	OEM
REC984491	984491



REF	OEM
REC305185	305185



REF	OEM
REC1397-2150	983870 910139



REF	OEM
REC308239	308239



REF	OEM
REC35-53336	908034



FILTRO COMBUSTIBLE ALTA PRESIÓN

FUEL FILTER HIGH PRESSURE

FILTRO BENZINA ALTA PRESSIONE

FILTRE A ESSENCE HAUTE PRESSION

REF	OEM	2T STROKES	4T STROKES
REC15440-93J00	5034985	BJ/J200, BJ/J225 6 Cyl (2004-07)	✓



REF	OEM	2T STROKES	4T STROKES
REC15410-87J00	5031400	E40, 50 J40, 50 BJ40, 50 (1999+)	✓



REF	OEM	2T STROKES	4T STROKES
REC15440-99E01	5030706	60, 70 HP (1998-02)	✓



new

REF	OEM	2T STROKES	4T STROKES
REC15440-90J00	5033704	90-140 HP	✓



new

FILTRO COMBUSTIBLE VST BAJA PRESIÓN

FUEL FILTER VST LOW PRESSURE

FILTRO BENZINA VST BASSA PRESSIONE

FILTRE À ESSENCE BASSE PRESSION

REF	OEM	2T STROKES	4T STROKES
REC69J-24501-10	5034995	200, 225 HP V6 (2004-07)	✓



new

FILTRO DE ACEITE

OIL FILTER

FILTRO OLIO

FILTRE A HUILE

REF	OEM		2T STROKES	4T STROKES
REC16510-05240	5033102, 7		9.9 - 15 HP (2002-07)	✓
 REC09280-54001	5033009			



REF	OEM		2T STROKES	4T STROKES
REC16510-90J00	5033539 778886		90-115 HP (2003+) EFI	✓



REF	OEM		2T STROKES	4T STROKES
REC434839	434839		9.9 Et 15 HP (1995-01) 70 HP (-1998)	✓



REF	OEM		2T STROKES	4T STROKES
REC16510-82703	5033919 778887		140 HP (2003+) EFI	✓



REF	OEM		2T STROKES	4T STROKES
REC16510-87J00	5031411 778885		25-70 HP (1998-05)	✓



REF	OEM		2T STROKES	4T STROKES
REC16510-93J00	5035703 778888		200-225 HP (2004+)	✓



JUNTA TAPON CARTER

OIL DRAIN PLUG GASKET

GUARNIZIONE TAPPO

JOINT DE VIDANGE

REF	OEM	
REC09168-12012	5030465	30HP+



REF	OEM	
REC09168-12017	5031863 5032987	4-30 HP



ACEITE

OIL

OLIO

HUILES

REF			
REC2TU6	1 L	6	2 STROKES
REC2TU3	5 L	3	TC-W3
REC5W40U6	1 L	6	SAE 5W40
REC5W40U3	5 L	3	
REC10W30U6	1 L	6	SAE 10W30
REC10W30U3	5 L	3	
REC10W40U6	1 L	6	SAE 10W40
REC10W40U3	5 L	3	
REC25W40U3	5 L	3	SAE 25W40
REC80W90U3	5 L	3	SAE 80W90
REC80W90U6	1 L	6	



new



REF			
RM92-858026QB1U6	1 L	6	2 STROKES
RM92-858027QB1U3	3,8 L	3	
RM92-8M0086220U6	1 L	6	SAE 10W30
RM92-8M0086221U3	4 L	3	



RM92-858026QB1U6

RM92-858027QB1U3

RM92-8M0086220U6

RM92-8M0086221U3

BOMBA DE COMBUSTIBLE

FUEL PUMP

POMPA BENZINA

POMPE À ESSENCE

BOMBA DE COMBUSTIBLE MECANICA

FUEL PUMP MECHANICAL

POMPA BENZINA MECCANICA

POMPE À ESSENCE MECANIQUE

REF	OEM		2T STROKES	4T STROKES
PAF4-04090000	5037518 5033371		4, 5, 6 HP	✓



new

REF	OEM		2T STROKES	4T STROKES
REC1399-07351	438562		9,9, 15 HP (1993-02)	✓



REF	OEM		2T STROKES	4T STROKES
REC1399-07350	397839		6, 8, 9,9, 15 HP	✓



REF	OEM		2T STROKES	4T STROKES
REC1399-07353	438555		20 - 30 HP (1990-00)	✓



REF	OEM		2T STROKES	4T STROKES
REC1399-07352	438556	25 - 50 HP (1976-99) Sin VRO Without VRO Senza VRO Sans VRO	✓	



REF	OEM		2T STROKES	4T STROKES
REC438559	0438559 0765591	EVINRUDE: BE25, BE35, E25, E35, SE105, SE125 JOHNSON: BJ25, J25, J115, SJ125 (1997-05)	✓	



BOMBA DE COMBUSTIBLE ELECTRICA **FUEL PUMP ELECTRIC**

REF	OEM		2T STROKES	4T STROKES
REC63P-13907-03	5032617 5033702 5036635 5030700	E40, J40, BJ40 E50, J50, BJ50 E70, J70, BJ70 J60, BJ60 (2001-06)		✓



POMPA BENZINA ELETTRICA **POMPE À ESSENCE ELECTRIQUE**

REF	OEM		2T STROKES	4T STROKES
REC5004428	5004428 5000800 0439347	75 HP (2000-03) 90 HP (1998-03) 100 HP (2004-05) 115 HP (1998-06) 135 HP (2000-06) 150 Et 175 HP (1999-06) 4 Et 6 CYL (3.600 Bore)	✓	



JUNTAS BOMBA DE COMBUSTIBLE **FUEL PUMP GASKETS**

REF	OEM
REC338876	338876



REF	OEM
REC303615	303615



GUARNIZIONI POMPA **JOINTS POMPE À ESSENCE**

REF	OEM
REC338879	338879



KITS BOMBA COMBUSTIBLE **KIT, FUEL PUMP**

REF	OEM
REC398514	398514



KIT POMPA BENZINA **KIT POMPE ESSENCE**

REF	OEM
REC393088	393088



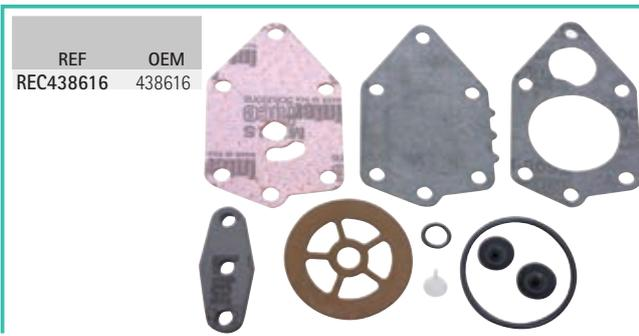

VÁLVULA CHECK VALVE VALVOLA SOUPAPE

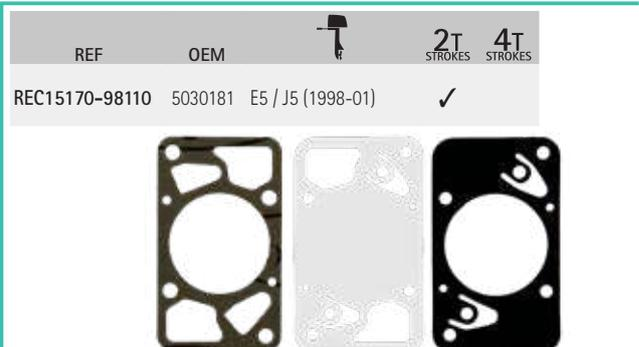

JUNTAS VST VST GASKETS GUARNIZIONE VST JOINTS VST

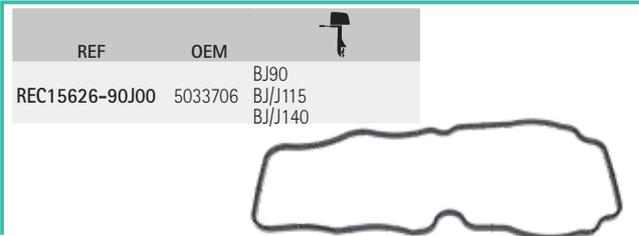
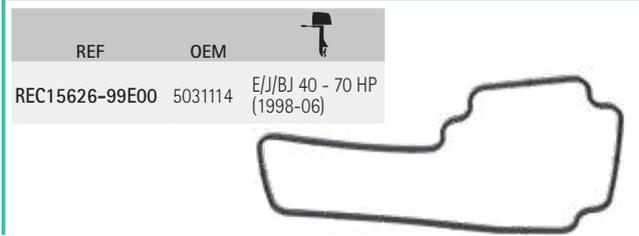

GUÍA DE MEMBRANAS DIAPHRAGM SET APPLICATION GUIDA MEMBRANA GUIDE DIAPHRAGME

	OE	REF	2T STROKES	4T STROKES
2,5	1987-88	REC393088		
4	1982-95	REC393088		
4, 5, 6	2003-07	REC15170-91J00		✓
4.0 Deluxe	1992-93	REC393088		
4.5	1982-87	REC393088		
5	1985-93	REC393088		
5	1998-01	REC15170-98110		✓
6	1986-93	REC393088		
6.5	1989-90	REC393088		
7.5	1982-83	REC393088		
8	1984-93	REC393088		
9.9, 15	1981	REC393103		
9.9, 15	1982-92	REC393088		
9.9, 15 elec.	1990	REC438616		
9.9, 15	2005-07	REC15170-94J00		✓
10/14	1989-90	REC393088		
J10 - J70	1998-07	REC15170-99E00		
14	1988	REC393088		
20, 25	1982-84	REC393103		
20, 25, 30	1987	REC398514		
20, 25	1988-89	REC432962		
20, 25, 30 Ro	1990	REC432962		
20, 30	1990	REC438616		
20, 30, 35 Re	1990	REC432962		
20, 35 Rope	1989-90	REC432962		
25 Com	1982	REC393103		
25 Com	1988-90	REC432962		
E25, E30, E40, E50, E70	1998-07	REC15170-99E00		
28	1987	REC398514		
30	1984	REC393103		
40	1987	REC398514		
40	1990	REC438616		
40/50	1988	REC432962		
BJ40 - BJ70	1998-07	REC15170-99E00		

	OE	REF	2T STROKES	4T STROKES
45, 55	1985-86	REC398514		
45, 55	1987	REC398514		
45, 55 Com	1989-90	REC398514		
45, 48, 50	1989	REC438616		
48	1987	REC398514		
48	1988-90	REC432962		
48	1987	REC398514		
48	1988	REC432962		
48, 50	1990	REC432962		
50, 60	1982-84	REC393103		
55	1983	REC393103		
55 Com	1984	REC393103		
60	1988	REC398514		
65	1985-87	REC393103		
65	1990	REC398514		
65 Com	1984	REC393103		
65 Com	1988-89	REC398514		
70/75	1982-84	REC393103		
70	1990	REC398514		
80	1978-83	REC393103		
88	1987	REC398514		
88/90/110	1988-89	REC398514		
88/90/100/115	1990	REC398514		
90/115	1983	REC393103		
90/115/140	1982	REC393103		
100 Com	1989-90	REC398514		
115 Com	1989-90	REC398514		
V4 140	1983	REC393103		
150/175/200	1982	REC393103		
V6 150/175	1983	REC393103		
155 Com	1989-90	REC398514		
V6 235	1983	REC393103		
2.6	1984	REC398514		
3.0	1991-93	REC393088		

INYECTORES INJECTOR INNIETTORE INJECTEURS

INYECTOR COMBUSTIBLE FUEL INJECTOR INNIETTORE COMBUSTIBILE INJECTEURS ESSENCE

REF	OEM		2T STROKES	4T STROKES
REC15710-66D00	5032693	60HP (4 CYL) (2002-06) 70 HP (4 CYL) (2001-06)		✓



REF	OEM		2T STROKES	4T STROKES
REC15710-65D00	5033708	90, 100, 115 HP (4 CYL) (203-06)		✓



new

REF	OEM		2T STROKES	4T STROKES
REC15710-87J00	5031403	40, 50HP (3 CYL) (2002-06)		✓



REF	OEM		2T STROKES	4T STROKES
REC15710-99E00	5030708	70HP (4 CYL) (1998-00)		✓



REF	OEM	 2T	 4T
		STROKES	STROKES
REC15710-93J00	5035010	200, 225HP (2004-06)	✓

new





P 38

REF
STA93008
STA93016



P 38

REF
GE22207

CARBURADOR CARBURATOR CARBURATORE CARBURATEUR

CARBURADOR COMPLETO FULL CARBURATOR CARBURATORE COMPLETO CARBURATEUR COMPLET

REF	OEM	 2T	 4T
		STROKES	STROKES
REC13200-91J70	5036549 5036191 5036192	4, 5, 6 HP	✓

new



KITS CARBURADORES CARBURETOR KITS KIT CARBURATORI KIT CARBURATEUR

REF	OEM
REC438996	435442 438996



REF	OEM
REC439071	439071 398532 383067 383052 382049



REF	OEM
REC439078	435752 439078 435678 43577 435676



REF	OEM
REC439072	439072 398452 391305 398453



REF	OEM	
REC13910-89J01	5032424	E25 / J25 E30 / J30 (2000-06)

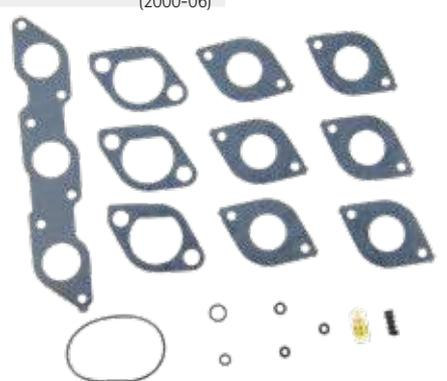

REF	OEM	
REC18-7761	4, 8 HP (2007)	



REF	OEM
REC396701	396701 398729 392061



REF	OEM
REC439076	439076 434888 435443 398526 392550



REF	OEM
REC439074	4359073



REF	OEM
REC439075	439074 439075



REF: GEGC15

BOYAS		FLOATS		GALLEGGIANTE		FLOTTEUR DE CARBURATEUR	
REF	OEM	REF	OEM	REF	OEM	2T STROKES	4T STROKES
REC382363	382363			REC13250-95D01	5033086	10, 15 HP (2cyl)	✓



new

KIT AGUJA CARBURADOR		NEEDLE VALVE, KIT	KIT SPILLO CONICO CARBURATORE	KIT SIEGE, POINTEAU ET GICLEUR
REF	OEM		REF	OEM
REC387262	379312 387262		REC396521	378895 396521 678882
REF	OEM		REF	OEM
REC396522	379312 396522		REC396520	396520

RETENEDOR	RETAINER	FERMO	RETENUE
REF	OEM		
REC315232	315232	5 - 75 HP	

KIT DE VÁLVULA	VALVE KIT	KIT VALVOLA	KIT SOUPAPE
REF	OEM		
REC18-7044		9,9, 15 HP	

LEVA ACELADOR	ACCELERATOR CAM	CAMMA ACCELERATORE	CAME D'ACCELÉRATEUR
REF	OEM		
REC0323327	0323327	2 - 15 HP	

GUÍA KITS CARBURADOR	GUIDE, CARBURATOR KIT	GUIDA KIT CARBURATORE	GUIDE KITS CARBURATEURS
----------------------	-----------------------	-----------------------	-------------------------

KIT				KIT				KIT																												
2	3	3	4	4	4	4.5	5	5	5	5.5	6	6	6	6	7.5	7.5	8	8	8	8	9.9	9.9	14	15	15	18	20	20	20	20	25	SAIL	DR	25	25	
1970-90	1952-67	1968	1965-78	1983-89 1991-93	2007	1982-84,87	1965-67	1968	1984-85	1954-67	1954-79	1968	1984-85	1986	1955-58	1982-83	1984-85	1986	2007	1974-88	1989	1968	1989	1974-88	1957-68	1969-73	1957-68	1969-90	1991-97	1991-95	1954-55	1978-90	1969-95	1991-95		
REC439071	REC439071	REC439071	REC439071	REC439072	REC18-7761	REC439072	REC439071	REC439075	REC439072	REC439071	REC439071	REC439075	REC439072	REC439074	REC439071	REC439072	REC439072	REC439074	REC18-7761	REC439072	REC439074	REC439072	REC439072	REC439071	REC439071	REC396701	REC396701	REC396701	REC439074	REC439078	REC439075	REC396701	REC396701	REC396701	REC439078	
REC396522	REC396521	REC396522	REC396522	REC396522		REC396522	REC396522	REC396521	REC396522	REC396522	REC396522	REC396521	REC396522	REC396522	REC396522	REC396522	REC396522	REC396521	REC396522	REC18-7761	REC396522	REC396522	REC396522	REC396522	REC396522	REC396521	REC396521	REC396521	REC396521	REC396521	REC396521	REC396521	REC396521	REC396521	REC396521	REC396521
25 (4T/Stroke)	28	28	28	30	30	30 (4T/Stroke)	33	35	35	35	40	40	40	40	45	45	48	50	50	55	55	60	60	60	60	65	65	70 (3 Cyl)	70	75	85	85	V-4	88, 90		
2004	1962-64	1976-95	1992-93	1956	1976-95	2004	1965-70	1957-59	1976-95	1991-3	1960-63 1965-78	1971-92	1993	1971-95	1992	1992-95	1958-59	1993	1968-69 1971-95	1971-95	1992	1964-67	1970-95	1992-93	1972-95	1992-93	1972-95	1975-88	1971-79	1969-70 1991-93	1969-79 1983-84	1985-88	1988 1991-93			
REC13910-89J01	REC439075	REC396701	REC439078	REC396701	REC439078	REC13910-89J01	REC439075	REC439075	REC396701	REC439078	REC439075	REC396701	REC439078	REC396701	REC396701	REC439078	REC396701	REC396701	REC396701	REC396701	REC396701	REC439078	REC439078	REC439078	REC396701	REC396701	REC396701	REC396701	REC396701	REC396701	REC396701	REC396701	REC396701	REC396701	REC396701	
90	100	100	100	110	115	115	V-6	115	120	125	125	125C	135	140	140	140	140	150	150 C	150	150	155	175	175	185	185	200	200	200	200	225	235	250	275 (3.6L)	300	
1981-83	1971, 980	1972, 979	1985-95	1985-90	1969 1980-95	1970 1973-79	1976-90	1983	1985-94	1971-72	1993-94	1989-95	1973-76	1977	1980-83	1978-79	1986-90 1993-94	1979-90	1993	1992-93	1984-93	1977-91	1992-93	1984	1989-93	1976-83	1987-90	1992-93	1986-93	1978-84	1991-93	1985-88	1988 1991-93			
REC439076	REC439076	REC439076	REC439076	REC439076	REC439076	REC396521	REC439076	REC439076	REC439078	REC396521	REC439078	REC439078	REC439078	REC439076	REC439078	REC439078	REC439078	REC439078	REC439078	REC439078	REC439078	REC439078	REC439078	REC439078	REC439078	REC439078	REC439078	REC439078	REC439078	REC439078	REC439078	REC439078	REC439078	REC439078	REC439078	
REC387262	REC387262	REC396521	REC387262	REC387262	REC387262	REC396521	REC387262	REC387262	REC396522	REC396521	REC396522	REC396522	REC396521	REC387262	REC396521	REC396522	REC396522	REC396521	REC387262	REC396522	REC396522	REC387262	REC387262	REC396522	REC387262	REC396522	REC387262	REC396522	REC396522	REC396522	REC396522	REC396522	REC396522	REC396522	REC396522	

SISTEMA ELÉCTRICO ELECTRIC SYSTEM

SISTEMA ELETTRICO SYSTÈME ELECTRIQUE

SENSORES	SENSORS	SENSORE	CAPTEURS
SENSOR MAP/MAT	MAP/MAT SENSOR	SENSORE MAP/MAT	CAPTEUR MAP/MAT

REF	OEM		2T STROKES	4T STROKES
REC18590-72F21	5033780	200, 225 HP 90, 115, 140 HP		✓



new

SENSOR IAT	IAT SENSOR	SENSORE IAT	SONDE IAT
------------	------------	-------------	-----------

REF	OEM		2T STROKES	4T STROKES
REC13650-52G00	5031392	40, 50, 90, 115, 140, 200, 225 HP		✓



new

REF	OEM		2T STROKES	4T STROKES
REC13650-56B00	5030687	60, 70 HP		✓



new

SENSOR IAC	IAC SENSOR	SENSORE IAC	SONDE IAC
------------	------------	-------------	-----------

REF	OEM		2T STROKES	4T STROKES
REC18137-52D00	5035412	200, 225 HP (2003-08)		✓



new

SENSOR CMP	CMP SENSOR	SENSORE CMP	SONDE CMP
------------	------------	-------------	-----------

REF	OEM		2T STROKES	4T STROKES
REC33220-76G02	5031468 5032786	40, 50, 90, 115, 140 HP		✓



new

BOBINAS

COILS

BOBINE

BOBINES

BOBINA

COIL

BOBINA

BOBINE

REF	OEM
REC0502880	581407
REC0502881	502881 581786



REF	OEM	2T STROKES	4T STROKES
REC33410-94400-000	5032732	10 - 15 HP (2002-04)	✓



REF	OEM
REC0502888	582888 582091



REF	OEM
REC584561	584561 582366 583737



REF	OEM
REC0502890	502890 582160 584632



REF	OEM
REC0583740	583740



REF	OEM
REC0582508	582508



REF	OEM
REC0584477	584477



GUÍA DE BOBINAS

GUIDE, COILS

GUIDA BOBINA

GUIDE DES BOBINES

		KIT	UNIT			KIT	UNIT			KIT	UNIT
1.5, 2 COLT, JR.	1968-90	REC0584477	1	8	1985-90	REC0582508	2	25	1973-76	REC0502881	2
2, 2.2, 3	1995	REC0583740	1	9.5	1964-73	REC0584477	2	25	1977-84	REC584561	2
3	1952-68	REC0584477	1	9.9, 15	1974-76	REC0502880	2	25	1985	REC0582508	2
4	1950-76	REC0584477	1	9.9, 15	1977-84	REC584561	2	25 COMM	1985-91	REC0582508	
	1981-89			9.9, 15	1985	REC0582508	2	25 COMM	1956-70	REC0584477	2
4	1977-80	REC584561	1	9.9, 15	1993-95	REC0583740	1	28	1987-88	REC584561	2
4 DELUXE	1985	REC0582508	2	9.9, 15	1994	REC584561	2	28	1997-98	REC0583740	2
4.5	1980-84	REC584561	2	(4T/Stroke)				28	1989	REC0582508	2
4.5	1986-87	REC0582508	2	10 - 15	2002-04	REC33410-94400-000		30	1956-70	REC0584477	2
5	1950-76	REC0584477	2	10	1951-63	REC0584477	2	30	1977-84	REC584561	2
5	1985-91	REC0582508	2	10, 14 COMM	1989-90	REC584561	2	30	1985	REC0582508	2
5.5 - 6	1950-76	REC0584477	2	14	1988	REC584561	2	33,35	1956-70	REC0584477	2
6	1977-84	REC584561	2	15	1951-72	REC0584477	2	35	1976	REC0502881	2
6	1985-90	REC0582508	2	18	1951-72	REC0584477	2	35	1977-84	REC584561	2
6.5 COMM	1989-90	REC0582508	2	18,2	1973	REC0502881	2	40	1960-73	REC0584477	2
6.8	1991-99	REC0583740	1	20	1951-72	REC0584477	2	40	1974	REC0502880	2
7.5	1954-58	REC0584477	2	20	1985	REC0582508	2	40 (B)	1975-83	REC0502881	2
7.5	1980-84	REC584561	2	25	1951-72	REC0584477	2	40	1977-84	REC584561	2
8	1980-84	REC584561	2					40	1985-88	REC0582508	2

KIT				UNIT				KIT				UNIT			
40 COMM	1985-90	REC0582508	2	85	1978-84	REC584561	4	150	1976-78	REC0502888	1				
45 COMM	1985-92	REC0582508	2	85	1985	REC0582508	4	150	1979-84	REC584561	6				
45 SS	1987-90	REC0582508	2	88	7987	REC0582508	4	150 (A)	1985	REC0582508	6				
45	1989-96	REC0583740	2	90	1978-84	REC584561	4	155 COMM (A)	1984	REC0582508	6				
48	1987	REC0582508	2	90	1985-94	REC0582508	4	2500 CC	1988	REC0582508	6				
50	1971-75	REC0502890	2	90	1995-99	REC0583740	2	175 V6	1991-99	REC0583740	3				
50	1978-84	REC584561	2	100	1971-72	REC0582382	1	175	1976-78	REC0502888	6				
50	1985-88	REC0582508	2	100	1978-84	REC584561	4	175	1979-84	REC584561	6				
55	1978-84	REC584561	2	100	1985	REC0582508	4	175 (A)	1985	REC0582508	6				
60	1978-84	REC584561	2	1600 CC	1988	REC0582508	4	185	1984	REC0582508	6				
60	1985	REC0582508	3	110	1986-90	REC0582508	4	200	1976-78	REC0502888	6				
60 SST	1989-90	REC0582508	3	115	1969-70	REC0582382	1	200	1979-84	REC584561	6				
65	1971-75	REC0502890	3	115	1973-74	REC0502890	4	200	1985	REC0582508	6				
65	1979-84	REC584561	3	115	1976-77	REC0502888	4	225	1986	REC0582508	6				
65 COMM	1985	REC0582508	3	115	1978-94	REC584561	4	235	1976-78	REC0502888	6				
70	1974-75	REC0502890	4	120	1985	REC0582508	4	235	1979-84	REC584561	6				
70	1979-84	REC584561	3	125	1971-72	REC0582382	1	250	1991	REC0582508	8				
70	1985	REC0582508	3	125	1991	REC0582508	4	275	1985	REC0582508	8				
70	1974-74	REC0502890	1	125 COMM	1989	REC0582508	4	300, 3.6	1985	REC0582508	8				
75	1979-84	REC584561	3	135	1973-75	REC0502890	4	SAIL DRIVE	1978-84	REC584561	2				
75	1985	REC0582508	3	135	1976	REC0502888	4	SAIL DRIVE	1985	REC0582508	2				
85	1969-72	REC0582382	1	135	1977	REC0502888	4								
85	1973-75	REC0502890	1	140	1978-84	REC584561	4								
85	1976-77	REC0502888	4	140	1985	REC0582508	4								

BUJÍAS SPARK PLUG CANDELE BOUGIES

JOHNSON

		NGK		CHAMPION		2T	4T			NGK		CHAMPION		2T	4T
						STROKES	STROKES							STROKES	STROKES
2.0 Excel 4, Ultra	1988-87	NGKB7HS	CHAUL81C					9.9, 2 T, OHC	2001-77	NGKBR7HS	CHAQL82C				
2.0 Colt, Jr	1990-71	NGKBR6S	CHARJ8C					10 COM	2003-94	NGKBR7HS	CHAL82C				
2.0, 2R	1984-71	NGKBR6S	CHAJ8C					10 COM	1993-92	NGKBZ7HS-10	CHAQL82C				
2.0 (1 Cyl)	2001-91	NGKBPR6HS	CHAQL87YC					10 COM	1982-81		CHAL82C				
2.3 (1 Cyl)	1998-91	NGKBPR6HS	CHAL87YCC					14 COM	1991-81	NGKBZ7HS-10	CHAQL77JC4				
2.5	1988-87	NGKBR6HS	CHAQL87YC					14	1989-88	NGKBZ7HS-10	CHAL77JC4				
3.0 (2 Cyl)	1997-89	NGKBR6HS	CHAL87YCC					15 Kero	1998-95	NGKBUHXW-1	CHAQL77JC4				
3.3 (1 Cyl)	2003-91	NGKBPR6HS	CHAQL82C					15 COM	2001-94	NGKBR7HS	CHAL82C				
4.0 Excel, Ultra	1988-87	NGKBZ7HS-10	CHAL82C					15 COM	1993-92	NGKBZ7HS-10	CHAQL77JC4				
4.0 (2 Cyl)	2003-89	NGKBR6HS	CHAQL77JC4					15 OHC	2003-95	NGKDCPR7E	CHAL77JC4				✓
4.0	1988	NGKBZ7HS-10	CHAL82C					15	2001-94	NGKBR7HS	CHAQL82C		✓		
4.0	1987-77	NGKBR6HS	CHAQL77JC4					15	1992-77	NGKBZ7HS-10	CHAL82C				
4.0	1984-81	NGKBZ7HS-10	CHAL77JC4					15	1980-78		CHAQL77JC4				
4.0	1976-69	NGKBR6S	CHARJ8C					15	1976-74	NGKB7HS	CHAL78V				
4.5	1985-80	NGKBR6HS	CHAJ8C					15	1971-56	NGKBR6S	CHAUL81C				
5.0 Angler	1968-65	NGKBR6S	CHAQL82C					18 Jet (2 Cyl)	1998-95	NGKBR7HS	CHARJ8C				
5.0 (1 Cyl)	2001-98	NGKBZ7HS-10	CHAL82C					20 Jet (2 Cyl)	2001-99	NGKBR7HS	CHAQL82C				
5.0	1997-90	NGKBR6HS	CHARJ8C					20, (2 Cyl)	1998-78	NGKBR7HS	CHAL82C				
6.0, 6R, 6RL	1976-71	NGKBR6S	CHAJ8C					20	1993-78	NGKBR7HS	CHAQL82C				
6.0	2001-77	NGKBR6HS	CHAQL77JC4					25 COM	2002-81	NGKBUHXW-1	CHAL82C				
6.0	1976-65	NGKBR6S	CHAL82C					25, (3 Cyl)	2001-95	NGKBR6HS	CHAQL82C				
6.5 COM	1993-81	NGKBR6HS	CHARJ8C					25, E,EL,R,RL	1976-73	NGKBR6S	CHAQL82C				
7.5	1997-77	NGKBR6HS	CHAJ8C			✓		25, (2 Cyl)	2002-77	NGKBR7HS	CHAL82C				
8.0 COM	2001-77	NGKBR6HS	CHAQL82C					25	1976-69	NGKBR6S	CHAQL82C				
8.0	2001-77	NGKBR6HS	CHAL82C					28, SPL, (2 Cyl)	1997-78	NGKBR7HS	CHAL82C				
9.9 4 T, OHC	2003-95	NGKDCPR7E	CHAQL82C			✓		28 Jet	2003-92	NGKBPZ8HS-10	CHAQL78YC				
9.9, 2 T SOHC	2003-02	NGKDCPR7E	CHAL82C					30 Jet (2 Cyl)	2001-99	NGKBPR7HS	CHAL78YC				
			CHARA8HC					30 OHC	2003-95	NGKDCPR7E	CHAQL82C				✓
			CHARA8HC					30, (2 Cyl)	2002-78	NGKBR7HS	CHAL82C				

			NGK	CHAMPION	2T STROKES	4T STROKES
35 Jet (2 Cyl)	2003-93	NGKBPZ8HS-10		CHAQL78YC CHAL78YC		
35, (3 Cyl)	2001-95	NGKBR7HS				
35, (2 Cyl)	1997-77	NGKBZ7HS-10		CHAQL77JC4 CHAL77JC4		
40 Jet (3 Cyl)	2001-99	NGKBR7HS		CHAQL82C CHAL82C		
40 COM 45 cid	2003-84	NGKBUHXW-1		CHAUL77V		
40 COM 43 cid	1990-81	NGKBR7HS		CHAQL82C CHAL82C		
40, E,EL,R,RL	1976-75	NGKBZ7HS-10		CHAQL77JC4 CHAL77JC4		
40 DOHC	2003-02	NGKDPCR7E		CHARA8HC		✓
40, (2 Cyl)	2002-89	NGKBPZ8HS-10		CHAQL78YC CHAL78YC		
40, (2 Cyl)	1988-80	NGKBZ7HS-10		CHAQL77JC4 CHAL77JC4		
45 COM	2002-84	NGKBUHXW-1		CHAUL77V		
48, SPL (2 Cyl)	1997-94	NGKBPZ8HS-10		CHAQL78YC CHAL78YC		
48, (2 Cyl)	1997-89	NGKBPZ8HS-10		CHAQL78YC CHAL78YC		
48, (2 Cyl)	1988-80	NGKBZ7HS-10		CHAQL77JC4 CHAL77JC4		
50, (3 Cyl)	1998-95	NGKBPZ8HS-10		CHAQL78YC CHAL78YC		
50, (2 Cyl)	2002-89	NGKBPZ8HS-10		CHAQL78YC CHAL78YC		
50, (2 Cyl)	1988-80	NGKBZ7HS-10		CHAQL77JC4 CHAL77JC4		
55 COM, (2 Cyl)	1995-94	NGKBPZ8HS-10		CHAQL78YC CHAL78YC		
55 COM	2003-86	NGKBUHXW-1		CHAUL77V		
55, (2 Cyl)	1989-76	NGKB7HS		CHAUL81C		
60 OHC	2005-02	NGKBPR6ES				✓
60, (3 Cyl) 56 cid	1998-94	NGKBPZ8HS-10		CHAQL78YC CHAL78YC		
60, (3 Cyl) 56 cid	1993-89	NGKBZ7HS-10		CHAQL77JC4 CHAL77JC4		
60, (3 Cyl) 49 cid	1989-75	NGKBZ7HS-10		CHAQL77JC4 CHAL77JC4		
60, (2 Cyl)	1985-80	NGKBZ7HS-10		CHAQL77JC4 CHAL77JC4		
65 COM, (3 Cyl)	1995-94	NGKBPZ8HS-10		CHAQL78YC CHAL78YC		
65 COM HC LC	2003-88	NGKBUHXW-1		CHAUL77V		
65 COM HC LC	1987-84	NGKBZ7HS-10		CHAQL77JC4 CHAL77JC4		
65 Jet CV4	1997-92	NGKBR7HS		CHAQL82C CHAL82C		
65, (3 Cyl)	1973-72	NGKBZ7HS-10		CHAQL77JC4 CHAL77JC4		
70, (3 Cyl) 56 cid	2001-97	NGKBPZ8HS-10		CHAQL78YC CHAL78YC		
70, (3 Cyl) 56 cid	1993-89	NGKBZ7HS-10		CHAQL77JC4 CHAL77JC4		
70, (3 Cyl) 49 cid	1989-75	NGKBZ7HS-10		CHAQL77JC4 CHAL77JC4		
75, (3 Cyl) 49 cid	1989-75	NGKBZ7HS-10		CHAQL77JC4 CHAL77JC4		
80 Jet CV4	2001-79	NGKBR7HS		CHAQL82C CHAL82C		
85, V4 Backtroller	1995-94	NGKBR7HS		CHAQL82C CHAL82C		
85	1993-86	NGKBZ7HS-10		CHAQL77JC4 CHAL77JC4		
85	1980-68	NGKB7HS		CHAUL81C		
88 CV4 SPL	1997-79	NGKBR7HS		CHAQL82C CHAL82C		
90 Turbojet CV4	1998-94	NGKBR7HS		CHAQL82C CHAL82C		
90 LV4 FFI	1998	NGKPZFR6H		CHAXC12PEPB		
90 LV4	2000-95	NGKBPZ8HS-10		CHAQL78YC CHAL78YC		
90 CV4	1998-79	NGKBR7HS		CHAQL82C CHAL82C		
100 V4	1980-79	NGKB7HS		CHAUL81C		
100 COM	2001-84	NGKBUHXW-1		CHAUL77V		

			NGK	CHAMPION	2T STROKES	4T STROKES
105 COM LV4	2003-97	NGKBPZ8HS-10		CHAQL78YC CHAL78YC		
105 LV6 105 Jet	2003-93	NGKBPZ8HS-10		CHAQL78YC CHAL78YC		
110 CV4	1997-79	NGKBR7HS		CHAQL82C CHAL82C		
112 CV4	1997-79	NGKBR7HS		CHAQL82C CHAL82C		
115 Turbojet CV4	1998-94	NGKB7HS		CHAUL81C		
115 LV4 FFI	1998	NGKPZFR6H		CHAXC12PEPB		
115 Fast Stike LV4	2002-95	NGKBPZ8HS-10		CHAQL78YC CHAL78YC		
115 CV4	1998-79	NGKBR7HS		CHAQL82C CHAL82C		
115 COM	1984-75	NGKB7HS		CHAUL81C		
115	1993-86	NGKBZ7HS-10		CHAQL77JC4 CHAL77JC4		
115	1979-73	NGKBZ7HS-10		CHAQL77JC4 CHAL77JC4		
115	1985	NGKBUHXW-1		CHAUL77V		
120 LV4	2003-85	NGKBPZ8HS-10		CHAQL78YC CHAL78YC		
125 COM	1972-71	NGKB7HS		CHAUL81C		
130 LV4	2003-85	NGKBPZ8HS-10		CHAQL78YC CHAL78YC		
135 Starflite	1984-73	NGKBUHXW-1		CHAUL77V		
140 LV4	2003-85	NGKBPZ8HS-10		CHAQL78YC CHAL78YC		
140	1984-73	NGKBUHXW-1		CHAUL77V		
150 LV6 FFI	1998-97	NGKPZFR6H		CHAXC12PEPB		
150 Fast Strike LV6	2002-91	NGKBPZ8HS-10		CHAQL78YC CHAL78YC		
150 CV6	1991-88	NGKBZ7HS-10		CHAQL77JC4 CHAL77JC4		
150 CV6	1987-78	NGKBUHXW-1		CHAUL77V		
150 COM LV6	1998-93	NGKBPZ8HS-10		CHAQL78YC CHAL78YC		
155 CV6	1987-78	NGKBZ8H		CHAQL16V		
155 COM CV6	1992-89	NGKBZ8H		CHAQL16V		
175 LV6 FFI	1998	NGKPZFR6H		CHAXC12PEPB		
175 Fast strike LV6	2002-91	NGKBPZ8HS-10		CHAQL78YC CHAL78YC		
175 CV6	1991-88	NGKBZ7HS-10		CHAQL77JC4 CHAL77JC4		
175	1987-77	NGKBUHXW-1		CHAUL77V		
185	1987-77	NGKBZ8H		CHAQL16V		
185	1993-90	NGKBZ7HS-10		CHAQL77JC4 CHAL77JC4		
200	1983-76	NGKBZ8H		CHAQL16V		
200 COM	1992	NGKBZ8H		CHAQL16V		
200 COM	1998-93	NGKBPZ8HS-10		CHAQL78YC CHAL78YC		
200 V6	1993-86	NGKBZ7HS-10		CHAQL77JC4 CHAL77JC4		
200 Venom LV6	2003-94	NGKBPZ8HS-10		CHAQL78YC CHAL78YC		
225 V6	1993-86	NGKBZ7HS-10		CHAQL77JC4 CHAL77JC4		
225 Venom LV6	2003-94	NGKBPZ8HS-10		CHAQL78YC CHAL78YC		
235	1985-78	NGKBUHXW-1		CHAQL16V		
250 LV6	2001-99	NGKBUHXW-1		CHAQL16V		
250 V8	1997-85	NGKBPZ8HS-10		CHAQL78YC CHAL78YC		
275	1988-85	NGKBPR7HS		CHAQL78YC CHAL78YC		
300 V8	1997-85	NGKBPZ8HS-10		CHAQL78YC CHAL78YC		

			NGK	CHAMPION	2T STROKES	4T STROKES
65, CV4 65 Jet	1997-92	NGKBR7HS		CHAQL82C CHAL82C		
65 COM, (3 Cyl)	1995-94	NGKBPZ8HS-10		CHAQL78YC CHAL78YC		
65 COM HOLO	1997-88	NGKBUHXW-1		CHAUL77V		
65 COM HOLO	1987-84	NGKBZ7HS-10		CHAQL77JC4 CHAL77JC4		
70 OHC 298cc	2003-98	NGKBPR6ES				✓
70, (3 Cyl) 56 cid	1998-94	NGKBPZ8HS-10		CHAQL78YC CHAL78YC		
70, (3 Cyl) 56 cid	1993-89	NGKBZ7HS-10		CHAQL77JC4 CHAL77JC4		
70, (3 Cyl) 49 cid	1989-75	NGKBZ7HS-10		CHAQL77JC4 CHAL77JC4		
75, (3 Cyl) 49 cid	1989-75	NGKBZ7HS-10		CHAQL77JC4 CHAL77JC4		
75 E-TEC	2005-04	NGKPZFR6H				
80 Jet CV4	1998-79	NGKBR7HS		CHAQL82C CHAL82C		
85, V4 Backtroller	1995-94	NGKBR7HS		CHAQL82C CHAL82C		
85	1993-86	NGKBZ7HS-10		CHAQL77JC4 CHAL77JC4		
85	1980-68	NGKB7HS		CHAUL81C		
88 CV4 SPL	1997-79	NGKBR7HS		CHAQL82C CHAL82C		
90 Tubojet CV4	1997-94	NGKBR7HS		CHAQL82C CHAL82C		
90 LV4 FFI	1998-00	NGKPZFR6H		CHAXC12PEPB		
90 LV4	1998-95	NGKBPZ8HS-10		CHAQL78YC CHAL78YC		
90 CV4	1998-79	NGKBR7HS		CHAQL82C CHAL82C		
90 E-TEC	2005-04	NGKPZFR6H				
100 V4	1980-79	NGKB7HS		CHAUL81C		
100 COM	1998-84	NGKBUHXW-1		CHAUL77V		
105 COM LV4	2003-97	NGKBPZ8HS-10		CHAQL78YC CHAL78YC		
105 LV6 105 Jet	2003-93	NGKBPZ8HS-10		CHAQL78YC CHAL78YC		
110 CV4	1997-79	NGKBR7HS		CHAQL82C CHAL82C		
112 CV4	1997-79	NGKBR7HS		CHAQL82C CHAL82C		
115 Turbojet CV4	1998-94	NGKB7HS		CHAUL81C		
115 LV4 FFI	2003-98	NGKPZFR6H		CHAXC12PEPB		
115 Intruder LV4	1998-95	NGKBPZ8HS-10		CHAQL78YC CHAL78YC		
115 CV4	1998-79	NGKBR7HS		CHAQL82C CHAL82C		
115 COM	1984-75	NGKB7HS		CHAUL81C		
115	1993-86	NGKBZ7HS-10		CHAQL77JC4 CHAL77JC4		

			NGK	CHAMPION	2T STROKES	4T STROKES
115	1979-73	NGKBZ7HS-10		CHAQL77JC4 CHAL77JC4		
115	1985	NGKBUHXW-1		CHAUL77V		
120 LV4	2003-85	NGKBPZ8HS-10		CHAQL78YC CHAL78YC		
125 COM	1972-71	NGKB7HS		CHAUL81C		
130 LV4	2003-85	NGKBPZ8HS-10		CHAQL78YC CHAL78YC		
135	1984-73	NGKBUHXW-1		CHAUL77V		
140 LV4	2003-85	NGKBPZ8HS-10		CHAQL78YC CHAL78YC		
140	1984-73	NGKBUHXW-1		CHAUL77V		
150 LV6 FFI	1998-97	NGKPZFR6H		CHAXC12PEPB		
150 Intruder LV6	1998-91	NGKBPZ8HS-10		CHAQL78YC CHAL78YC		
150 CV6	1991-88	NGKBZ7HS-10		CHAQL77JC4 CHAL77JC4		
150 CV6	1987-78	NGKBUHXW-1		CHAUL77V		
150 COM LV6	1998-93	NGKBPZ8HS-10		CHAQL78YC CHAL78YC		
155 CV6	1987-78	NGKBUHXW-1		CHAUL77V		
155 COM CV6	1992-89	NGKBUHXW-1		CHAUL77V		
175 LV6 FFI	1998	NGKPZFR6H		CHAXC12PEPB		
175 Intruder LV6	1998-91	NGKBPZ8HS-10		CHAQL78YC CHAL78YC		
175 CV6	1991-88	NGKBZ7HS-10		CHAQL77JC4 CHAL77JC4		
175	1987-77	NGKBUHXW-1		CHAUL77V		
185	1987-77	NGKBUZ8H		CHAQL16V		
185 COM	1993-90	NGKBZ7HS-10		CHAQL77JC4 CHAL77JC4		
200 Vindicator L	1998-94	NGKBPZ8HS-10		CHAQL78YC CHAL78YC		
200 V6	1993-86	NGKBZ7HS-10		CHAQL77JC4 CHAL77JC4		
200 LV6 FFI	2004-99	NGKPZFR6H		CHAXC12PEPB		
200 COM	1998-93	NGKBPZ8HS-10		CHAQL78YC CHAL78YC		
200 COM	1992	NGKBUHXW-1		CHAUL77V		
200	1983-76	NGKBUHXW-1		CHAUL77V		
225 Vindicator	1998-94	NGKBPZ8HS-10		CHAQL78YC CHAL78YC		
225LV6 FFI	2004-99	NGKPZFR6H		CHAXC12PEPB		
225	1993-86	NGKBZ7HS-10		CHAQL77JC4 CHAL77JC4		
235	1985-78	NGKBUHXW-1		CHAUL77V		
250 V8	1997-85	NGKBPZ8HS-10		CHAQL78YC CHAL78YC		
275	1988-85	NGKBPZ8HS-10		CHAQL78YC CHAL78YC		
300 V8	1997-85	NGKBPZ8HS-10		CHAQL78YC CHAL78YC		

JUEGOS DE CABLES, ALTO RENDIMIENTO

Núcleo del cable de Kevlar de 8 mm antimagnético. Funda de silicona amarilla. Terminales bujías con muelle de acero inox. Terminal del distribuidor de cobre. Terminales bobina. Silicona resistente a altas temperaturas. Garantía de 5 años.

Capuchón de silicona
Silicone jacket
Rivestimento in silicone
Capuchon en silicone



Rizado especial
Fiberglass braiding
Fibra di vetro
Tresse en fibre de verre

Terminal de acero inox
Stainless Steel terminal
Terminale di acciaio inox
Terminal en acier inox

REF	OEM	
REC15-201		5" = 12,7 cm
REC15-202		7" = 17,78 cm
REC15-203	84-813715A1	9" = 22,86 cm
REC15-204		12" = 30,48 cm

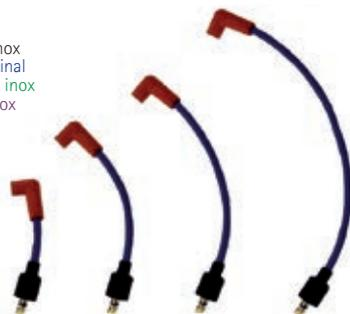

HD SPARK PLUG WIRE SET

Antimagnetic Kevlar core. Yellow silicone boot Et jacket. SS snaplock. Brass distributor terminal. Coil terminals. High resistant silicone. 5 year warranty.

KIT CAVI CANDELE, ALTE PRESTAZIONI

Nucleo del cavo di Kevlar da 8 mm antimagnetico. Copertura di silicone gialla. Terminali candele con molle di acciaio inox. Terminale lato spinterogeno in rame. Terminale Bobine. Silicone resistente alle alte temperature. Garanzia di 5 anni.

KIT FAISCEAU DE BOUGIE

Noyau en Kevlar antimagnétique. Gaine en silicone jaune. Bornes de bougie d'allumage avec ressort en acier inoxydable. Terminal de distribution en laiton. Bornes de bobine. Silicone haute résistance. Garantie 5 ans.

Camisa de silicona de 8 mm
8 mm silicone jacket
Rivestimento in silicone da 8 mm
Gaine silicone de 8mm



Látex resistente altas temperaturas
Heat resistant latex
Latex resistente alle alte temperature
Latex résistant à haute température

Núcleo de Kevlar
Kevlar core
Nucleo de Kevlar
Noyau de Kevlar

Acero inox
Stainless Steel
Acciaio inox
Acier inox

PIPA PARA BUJÍAS

SPARK PLUG PIPE

GOMITO PER CANDELE

CAPUCHON DE BOUGIE

Pipa de silicona para bujía con resistor. Conexión a prueba de agua.

Silicone pipe with resistor. Waterproof connection.

Gomito in silicone per candele. Connessione a prova di acqua.

Capuchon de bougie en silicone avec résistance. Connexion étanche

REF
CHAPROSU



MOTORES DE ARRANQUE STARTERS

MOTORINI AVVIAMENTO DEMARREUR

REF	OEM	⚡	☀️	🔧	2T STROKES	4T STROKES
PH130-0014	386430 586276	12V	10 CCW	8 HP (1996-98) 8 - 15 HP (1974-92)	✓	✓



REF	OEM	⚡	☀️	🔧	2T STROKES	4T STROKES
PH130-0061	5040343	12V	10 CCW	E10 / B10 (2012+)		✓



REF	OEM	⚡	☀️	🔧	2T STROKES	4T STROKES
PH130-0013	584608 586275	12V	10 CCW	L / E / BE 10 E / BE 15 J / BJ 10, 15 (1995-04) 9.9 - 15 HP (305 cc)		✓



REF	OEM	⚡	☀️	🔧	2T STROKES	4T STROKES
PH130-0006	5040786	12V	9 CCW	E15 / B15 (2012+)		✓



REF	OEM	⚡	☀️	🔧	2T STROKES	4T STROKES
PH130-0035	586768 587045	12V	9	E15 / 25 / 30 / 40 / 50 / 55 / 60 / 65 / 75 / 90 (2001+) E-TEC		✓



REF	OEM	⚡	☀️	🔧	2T STROKES	4T STROKES
PH130-0038	386591	12V	11	E20, 25, 28, E30, E35 HE25 BE20, BE25 BJ25, BJ30 J25, 30, 28, 35 TJ25 SJ25, 30 TE25 VE25 VJ25, VJ28 (1976-05)	✓	
	392133					
	585061					
	586278					
	277432					
	278232					
	378674					
	379091					
	379818					
	380139					
	380238					
	381864					
385401						
386597						



REF	OEM	⚡	☀️	🔧	2T STROKES	4T STROKES
PH130-0077	5036972	12V	9 CCW	J25 / BJ25 (2006-11)		✓



REF	OEM	⚡	☀️	🔧	2T STROKES	4T STROKES
PH130-0017	5583473 585059 778991	12V	9	VE25 / 28 / 30 TE25 / TE30 J20 / 25 / 30 / 35 TJ25 VJ25 / 28 / 30 / 35 (1988-93)		✓



REF	OEM	⚡	☀️	🔧	2T STROKES	4T STROKES
PH130-0026	586277 584818 778996	12V	10	BJ25, 35 HE35 HJ35 E25 / 35 J25 / 35 (1996+)		✓



REF	OEM	⚡	☀️	🔧	2T STROKES	4T STROKES
PH130-0016	583482 585056 586279	12V	9	E40 / 48 / 50, TE40 / 50 VE40 / 48 / 50, J40 / 48 / 50 TJ40 / 50, VJ40 / 48 / 50 E40 / 48 / 50, BE40 / 50 HE40, SE50 HJ40 BJ40 / 50 RJ50 X50 (1989-05)		✓



REF	OEM	⚡	☀️	🔧	2T STROKES	4T STROKES
PH130-0045	384163 387684 389275 585063 586280 778993	12V	9	40 - 60 HP (2cyl) (1971-99)		✓



REF	OEM	⚡	☀️	🔧	2T STROKES	4T STROKES
PH130-0043	383691 384777 386657 391735 585058 585197 586281	12V	9	55 - 75 HP (3 cyl) E70 / 75 BE50 / 60 / 70 J70 / 75 / 65 / 60 TJ60 / 70 VJ60 / 70 E 60 / 65 / 70 BJ 60 / 70 (1971-04)		✓



REF	OEM	⚡	☀️	🔧	2T STROKES	4T STROKES
PH130-0079	5030780	12V	8	E70 / B70 (1998-00)		✓



REF	OEM	⚡	☀️	🔧	2T STROKES	4T STROKES
PH130-0032	438878 586257	12V	8	75 - 175 HP (1991+) V4 & V6 Ficht	✓	



REF	OEM	⚡	☀️	🔧	2T STROKES	4T STROKES
PH130-0044	385529 389954 585057 585196 586282 586283 386465 389380 391554 585051	12V	10	80 - 140 HP (1973-98) V4 CROSS	✓	



REF	OEM	⚡	☀️	🔧	2T STROKES	4T STROKES
PH130-0071	5033799	12V	9	J90 / BJ90 J115 / BJ115 J140 / BJ140 (2003-06)		✓



REF	OEM	⚡	☀️	🔧	2T STROKES	4T STROKES
PH130-0027	584980 586284	12V	8	100 Comercial 1997, 80 Jet 1998 E90 / J90 / BJ90 / BE90 E115 BE115 HE115 L115 J115 BJ115 SJ115 (1995-06) V4	✓	



REF	OEM	⚡	☀️	🔧	2T STROKES	4T STROKES
PH130-0012	393570 585060 586285 778994	12V	10	120 - 140 HP (1985+)	✓	



REF	OEM	⚡	☀️	🔧	2T STROKES	4T STROKES
PH130-0018	432925 586286 586287	12V	10 CCW	150 - 175 HP V6 Eagle (1991+)	✓	



REF	OEM	⚡	☀️	🔧	2T STROKES	4T STROKES
PH130-0039	387094 395207 585062 586288 778992 777693	12V	8	150 - 235 HP V6 Cross	✓	



REF	OEM				2T STROKES	4T STROKES
PH130-0078	5035078	12V	9	J200, BJ200 J225, BJ225 (2004-06)		✓



REF	OEM				2T STROKES	4T STROKES
PH130-0008	391511 397023 396235 584799 586890 384799 586289 586411 586731 586897 586957	12V	10 CCW	V6 - V8 (115 - 300 HP) (1985+) Looper		✓



MUELLES ARRANQUE

REWIND SPRING

MOLLE AVVIAMENTO

RESSORT DE DÉMARRAGE

REF	OEM
REC93-08668	395460
REC0326877	326877
REC93-06511	312932
REC93-06522	323653 338534



MUELLES ARRANQUE
GUIA

REWIND SPRING
GUIDE

MOLLE AVVIAMENTO
GUIDA

GUIDE RESSORT DE
DÉMARRAGE

	REF
2	1969-80 REC93-06511
3	1954-68 REC93-08668
4	1969-92 REC93-06511
4	1969-80 REC93-06511
4	1981-92 REC0326877

	REF
4.5	1980-90 REC93-06511
5.5	1954-68 REC93-08668
7.5	1954-68 REC93-08668
9.9	1980-92 REC93-06522
10	1980-92 REC93-06522

	REF
10	1950-63 REC93-08668
12	1980-92 REC93-06522
12	1956-68 REC93-08668
15	1979-92 REC93-06522
15	1956-68 REC93-08668

	REF
18	1956-68 REC93-08668
20	1956-92 REC93-08668
28	1969-92 REC93-08668
25/30	1969-92 REC93-08668
35	1969-92 REC93-08668

MUELLE SEGURO
ARRANQUE

STARTER PAWL SPRING

MOLLE DI SICUREZZA
AVVIAMENTO

RESSORT DE SÉCURITÉ
DÉMARRAGE

REF	OEM	
REC93-08663	203697	20, 25, 30, 35 HP (1968-84)



REF	OEM	
REC93-08664	203725	25, 30, 35 HP (1968-84)



REF	OEM	
REC93-08665	330527	20, 25 HP (1985-97)



REF	OEM	
REC93-08667	335905	5, 6, 8, 10, 15, 25, 35 HP (1993-97)



REF	OEM	
REC93-08666	331970	3, 4, 5, 6, 8, 10, 15, 25, 35 HP (1993-97)



UÑAS ARRANQUE MANUAL

STARTER PAWL

PIASTRA AVVIAMENTO MANUALE

CLIQUET D'ARRET DU LANCEUR MANUEL

REF	OEM	
	2	1971-88
	JR / COLT	1990
	3	1957-67
	4	1978-90
	5.5	1957-64
	7.5	1957-76
	10	1957-62
	18	1957-73
REC300-01744	203698	25
		25
		35
		45
		50
		60
		75
		80



REF	OEM	
		20
		25
REC300-01633	330525	25C
		30
		30
		35



LLAVES DE ARRANQUE

IGNITION STARTER SWITCH

CHIAVI DI ACCENSIONE

CONTACTEUR A CLÉ

REF	OEM		POSICIONES POSITIONS POSIZIONE POSITIONS
GS11153	386545	6	3 OFF - RUN - START
MP39760	393301 508180		



MP39760



GS11153

REF	OEM		2T STROKES	4T STROKES
REC5005801	5005801 0175974	10 - 200 HP (1996+)	✓	✓



SOLENOIDE RELÉ

SOLENOID RELAY

SOLENOIDE RELE

SOLENOIDE RELAIS

REF	OEM			
PH375-0029	985063 892187 98410 778025 584128	(1987+)	12 V	3



REF	OEM			
REC584580	584580	9.9 / 15 HP (4 T/ Stroke) (1995-01) 8 HP (1996-98) 9.9 / 15 HP (1993+)	12 V	4



REF	OEM			
REC89-825096T01	5030783	9.9 - 70 HP (1998+)	12 V	4



REF	OEM		2T STROKES	4T STROKES
REC38860-76F01	5033264	10 - 225 HP		✓



new

REF	OEM			
PH375-0033	172869 581528 777699	9.9 - 235 HP (1975-92)	12 V	4



REF	OEM			
REC586774	586774 5009214	25 - 300 HP (2004+) E-Tec	12 V	4



REF	OEM			
PH375-0030	979774 778021	(1972-77)	12 V	3



REF	OEM			
REC3857533	584416 581295 582472 582473 586147 586224 777702	40 - 300 HP (1991+)	12 V	4



REF	OEM			
REC378444	378444 777700	18 - 80 HP (1966-85)	12 V	4



REF	OEM			
PH375-0027	586730 586842 778209 980801 981703 982189 985064 385389	75 - 250 HP (1997+)	12 V	4



REF	OEM			
PH375-0012	582708 395419 380095 383622 389398 389493 586180	20 - 300 HP (1992+)	12 V	4



TRIM

REF	OEM			
REC581528	581528 172869 777699	9.9 - 235 HP (1977-92)	12 V	4



REF	OEM		2T STROKES	4T STROKES
REC0586767	0586767 586767	15-300 HP (E-TEC)		✓



REF	OEM			
PH375-0047	5031483 5032195	25 - 115 HP (1999+)	12 V	3



REF	OEM			
PH375-0048	5032197	E25 / E30 (2000+)	12 V	3



REGULADORES Y RECTIFICADORES

REGULATOR AND RECTIFIERS

REGOLATORI E RADDRIZZATORI

REGULATEURS ET RECTIFIEURS

REF	OEM			
PH350-0002	581778	4-5 A	9.9, 15	1974-92
			20 (D)	1989-92
			25	1977-92
			28	1989-92
			30 (D)	1989-92
			35	1976-88
			40	1974-76
			40	1988-92
			45	1989-92 COMM
			45SS	1989-90
			48	1989-92
			55(A)	1978-81 1980-92



REF	OEM
PH350-0003	509219



REF	OEM			
PH350-0001	583408 582399	6-10 A	50	1971-75
			55	1976-77
			60	1970(E), 71
			60	1980-88
			60(F)	1989-91
			SST60	1989-90
			65	1972-73
			65	1988-91
			70(B)	1974-91
			75	1975-88
			85	1970-80
			88	1989-92
			90	1981-82
			100(C)	1971, 1979-80, 1984-92
			115	1973-92
			125	1971-72
			135(G)	1974
			140	1977-88
			150	1979-88
			155	1984-88
			175	1977-83
			185	1984-88
			200	1976-83
235	1978-88			



REF	OEM		2T STROKES	4T STROKES
REC32800-94620	5034255	4, 5, 6 HP		✓



REF	OEM		2T STROKES	4T STROKES
REC32800-95D01	5030356	5 - 15 HP (1998+)	✓	✓



REF	OEM		2T STROKES	4T STROKES
REC32800-94J11	5036261	10,15 HP	✓	



REF	OEM		2T STROKES	4T STROKES
REC0585081	0585081	10, 15 HP		✓



REF	OEM		2T STROKES	4T STROKES
REC32800-38F10	5036107	40, 50 HP		✓



REF	OEM		2T STROKES	4T STROKES
REC32800-89J11	5034680	J25, J30		✓



REF	OEM		2T STROKES	4T STROKES
REC32800-87J10	5032615	BJ40, BJ50, J40, J50		✓



REF	OEM		2T STROKES	4T STROKES
REC32800-89J00	5032030	E25, E30 (2000-01)		✓



REF	OEM		2T STROKES	4T STROKES
REC32800-92E20	5030795	J60, BJ60, J70, BJ70		✓

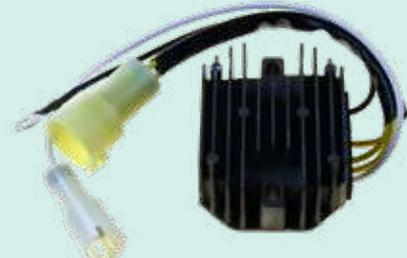

REF	OEM		2T STROKES	4T STROKES
REC300-03587	585001	25 - 70 HP (1992+)		✓



REF	OEM		2T STROKES	4T STROKES
REC0395204	395204	E85 (1992-95)		✓
	395391	E115 (1992-95)		
	395391	E150 (1986-91)		
	582904	E155 (1986-92)		
		E175 (1896-90)		



REF	OEM		2T STROKES	4T STROKES
REC300-03588	584890	25 - 35 HP (1995+)		✓



REF	OEM		2T STROKES	4T STROKES
REC32800-90J00	5033820 5036618	90-115 HP		✓



Cuerpo reciclado Recycled housing Corpo rigenerato Corps recyclé

REF	OEM		2T STROKES	4T STROKES
REC0585195	583529 584204 585195	90, 100, 115, 150, 175 HP (1989-98)	✓	



REF	OEM		2T STROKES	4T STROKES
REC300-03585	586075	V6 60°, 90-115 HP (1996+)	✓	



Cuerpo reciclado Recycled housing Corpo rigenerato Corps recyclé

REF	OEM		2T STROKES	4T STROKES
REC0763791	583512 584205 585192	120, 125, 130, 135, 140 HP (1991-98)	✓	

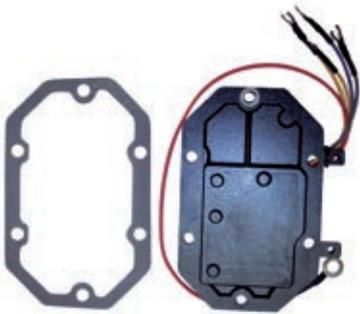

REF	OEM		2T STROKES	4T STROKES
REC300-03586	586048	V6 60°, 150-175 HP (1996+)	✓	



REF	OEM		2T STROKES	4T STROKES
REC0586271	586271 584641 585995	200, 225, 250 HP (1993-99)	✓	



REF	OEM		2T STROKES	4T STROKES
REC300-08010	439561	V6 60°, 150-175 HP (1991-95)	✓	



REF	OEM		2T STROKES	4T STROKES
REC0583689	583266 583689 586000 5844241	275, 300 HP (1986-90)	✓	

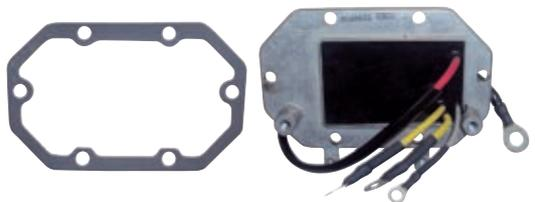

new

REF	OEM		2T STROKES	4T STROKES
REC32800-93J03	5036637	BJ200, BJ225		✓



GUÍA REGULADORES

REGULATORS GUIDE

GUIDA REGOLATORI

GUIDE REGULATEUR

		REF
25 / 40 / 50TL J Elec TR	1992	REC300-03587
25SIK / SIL / SIT	1994-1995	REC300-03587
25 / 35 3 Cyl	1995	REC300-03588
35JET / TL / J Elec.	1992-1993	REC300-03587
35JET / M-TE / TTL	1993-1995	REC300-03587
35JET / EL / TL / TTL	1996	REC300-03587
35JET Elec.	1997	REC300-03587
40 / 50TE / EL / TL / TTL	1993-1996	REC300-03587
40 / 50 Elec. 2T	1993-03	REC300-03587
60	1992-01	REC300-03587
65 Elec.	1992	REC300-03587
70	1974-91	REC300-03587
80 Jet	1992-94 & 1996	REC0585195
85	1992-95	REC0585195
88	1992-96	REC0585195
90-115 60° V4	1996	REC300-03585
90	1989-95	REC0585195
100 Comercial	1988-97	REC0585195
100	1991-94	REC0585195
110	1989	REC0585195
112	1994-96	REC0585195
115	1990-98	REC0585195
120	1988-90, 1992-94	REC0763791
125	1991-95	REC0763791
130	1994-2000	REC0763791
140	1988-1994	REC0763791
150 / 175 60° V6	1991-95	REC300-08010

		REF
150 / 175 60° V6	1996 Et up	REC300-03586
155 Comercial	1989-90	REC0585195
185 / 200 / 225	1993-94	REC0586271
185 / 200 / 225 / 200COM	1990-92	REC0583689
200 / 225	1986-1989	REC0583689
200 / 225 / 200COM	1994-97	REC0586271
250 / 300	1991-95	REC0586271
250	1997	REC0586271
275	1985-1986	REC0583689
275 / 300 (3.6L)	1987	REC0583689
275 / 300	1988	REC0583689
300 (3.6L)	1985-1986	REC0583689
300	1989-90	REC0583689
1.8 / 2.0L V4	1987-1990	REC0583689
2.7L V6	1986-87	REC0583689
3.0L V6	1988-90	REC0583689
3.0L V6	1993-98	REC0583689
3.6L V8	1987	REC0583689
4.0L V8	1989-1990	REC0583689
V4 & V6 Crossflow	Todos / All / tutti	REC0395204

CDI Y CAJAS NEGRAS

CDI & POWER PACK

CDI E CENTRALINA

CDI ET BOITIER ELECTRONIQUE

REF	OEM
REC0584035	583471 584034 584035



REF	OEM
REC0584041	583489 584040 584041

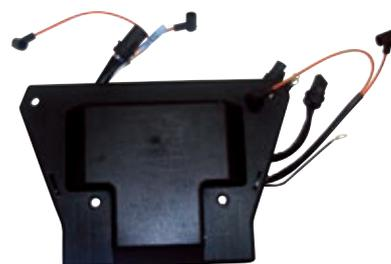

REF	OEM
REC0586661	584636 584637 585114 586212 586661

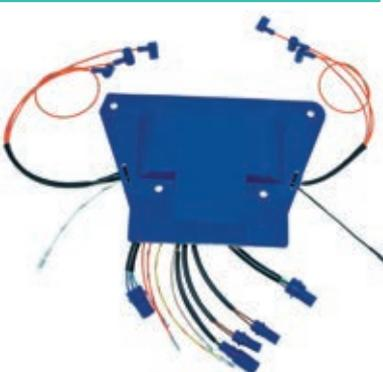

REF	OEM
REC0586667	583476 584036 584037 586217 586667

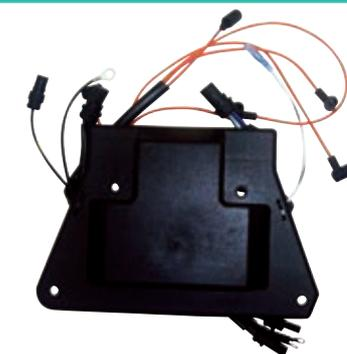

REF	OEM
REC0765386	586015 586098 586292



REF	OEM
REC0763803	584642



REF	OEM
REC0583865	583865



REF	OEM
REC584030	583777 584029 584030

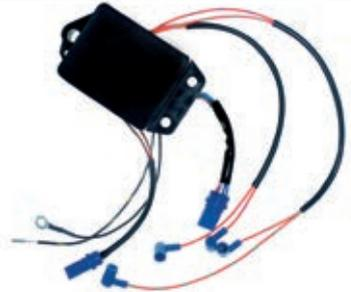

REF	OEM
REC0584986	584986 584988 584912 584989 584991



REF	OEM
REC0763793	582705



REF	OEM
REC0584985	584910 584985 584990



REF	OEM
REC0585274	585274



REF	OEM
REC0436367	436367 584122

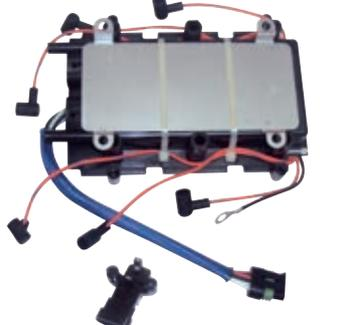

REF	OEM
REC0586798	584783



REF	OEM
REC5004532	584808 585145 585189 5004533



REF	OEM
REC0582262	5814014 582262 583041 583103 583336



REF	OEM
REC0584028	583773 584027 584028



REF	OEM
REC0175316	175316 585261 585262



REF	OEM
REC0586697	396141
	582281
	582285
	582502
	582757
	582880
	583167
	583168
	583169
	583170
583175	
583604	



REF	OEM	✂
REC0582642	582138	4
	582400	
	582642	
	582556	



REF	OEM
REC0582901	582474
	582864
	582901



REF	OEM	✂
REC0582125	582684	4
	582125	
	582454	
	581805	



REF	OEM
REC0586695	396077
	582261
	582504
	582714
	582800
	582889
	583172
	583174
	583241
	584508
584528	
584746	



REF	OEM	✂
REC0582452	582453	3
	583380	



REF	OEM
REC5001344	584767
	584768
	584908
	585074



REF	OEM
REC0583320	583122
	583320



REF	OEM
REC0582115	582115
	583125
	583143



REF	OEM
REC0583114	583114



REF	OEM	🔧
REC115742	115742	3.3 HP (1995+)

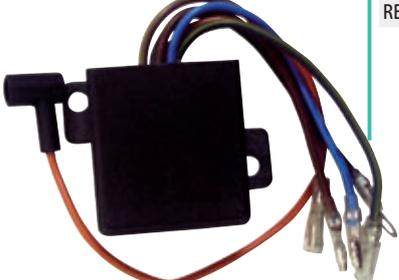

REF	OEM
REC0583748	583748



REF	OEM
REC300-26084	583663 583667 584488



REF	OEM	
REC0582057	582057	2 Cyl 

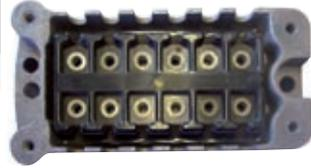

REF	OEM	
REC0764708	581397	2 Cyl 



REF	OEM
REC581726	581726

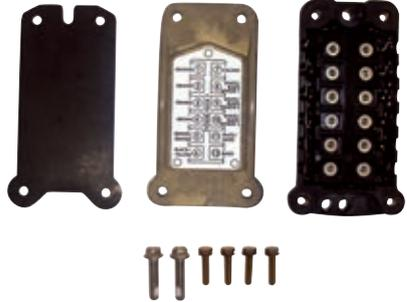

REF	OEM
REC0582056	581731 582056

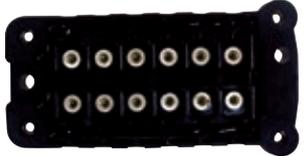

REF	OEM
REC300-26085	583896 584329 584331 584489



TRIGGERS

REF	OEM
REC0583387	583387



REF	OEM
REC0385008	384461 385008



REF	OEM
REC0586343	584265 584914 586343



REF	OEM
REC0763808	175386



REF	OEM
REC0763773	584804 763773

REF	OEM
REC0763776	583289
	583379
	582514
	583045
	763776

REF	OEM
REC763775	583533
	584586
	584840
	763775

REF	OEM
REC0763782	583508 763773

STARTOR

REF	OEM
REC5000611	581670
	584504
	584840
	585073

REF	OEM	
REC0583724	581957	9 A
	582506	
	582730	
	583119	
	583644	
	583724	

REF	OEM
REC0584333	583485
	584333

REF	OEM	
REC0763760	584849	20 A
	763760	

REF	OEM	
REC0584954	584954	6 A

REF	OEM	
REC0583670	582847	35 A
	583117	
	583670	

Remanufacturado Rebuilt Rigenerato Reconditioné

REF	OEM	⚡
REC0583672	582016	9 A
	582497	
	582867	
	583023	
	583104	
	583671	
	583672	
	581030	
	581987	



REF	OEM	⚡
REC0583668	582574	35 A
	583050	
	583274	
	583668	
	763785	

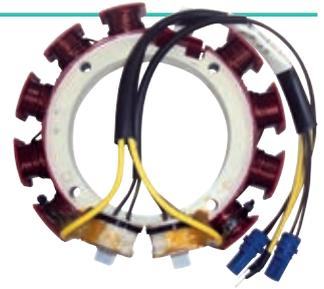

REF	OEM	⚡	🔧
REC0763759	584109	35 A 6 cyl	
	584981		



REF	OEM	⚡
REC0763769	583410	9 A
	763769	

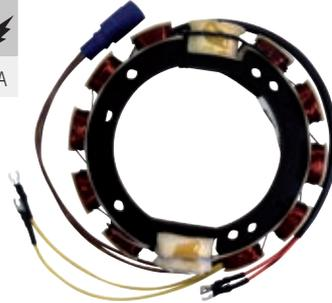

REF	OEM	⚡
REC0763767	583340	9 A
	583536	
	763767	



REF	OEM	⚡
REC0763770	581651	5 A
	584755	
	585087	
	763770	



REF	OEM	⚡
REC0763763	584560 763763	6 A
REC0763779	584643 763779	35 A



REF	OEM	⚡
REC0763765	583415	35 A
	584287	
	763765	

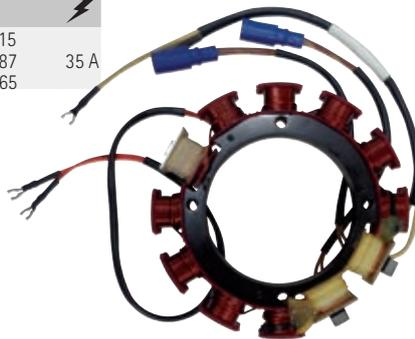

REF	OEM	⚡
REC0584288	583561	35 A
	584288	



REF	OEM	⚡
REC0583415	584287	35 A
	763765	



REF	OEM	⚡
REC0763764	583710	35 A
	584292	
	763764	

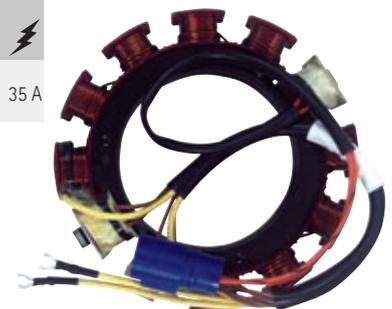

GUÍA	APPLICATION		GUIDA		GUIDE		
	CYL		2T STROKES	4T STROKES	CAJA NEGRA POWER PACK CENTRALINA BOITIER ELECTRONIQUE	STARTOR	TRIGGER
3.3	2	1995			REC115742		
4	2	77-84			REC0582452	REC5000611	REC0583387
4, 4.5, 5	2	1985			REC0586697	REC5000611	REC0583387
4	2	1994-96			REC0586697	REC5000611	REC0583387
5	2	1989-92			REC300-26084	REC5000611	REC0583387
5	2	1993-98			REC0586697	REC5000611	REC0583387
6	2	1977-84			REC0582452	REC5000611	REC0583387
6, 8	2	1985			REC0586697	REC5000611	REC0583387
6	2	1989-92			REC300-26084	REC5000611	REC0583387
6	2	1994-2000			REC0586697	REC5000611	REC0583387
8	2	1989-92			REC300-26084	REC5000611	REC0583387
8	2	1994-2003			REC0586697	REC5000611	REC0583387
9.9	2	1985-88			REC0586697	REC5000611	REC0583387
9.9	2	1989-92			REC300-26084	REC5000611	REC0583387
9.9	2	1993			REC0586798	REC0763770	REC0583387
9.9	2	1994-95			REC0586798	REC0763770	
9.9 MAN.	2	1996-2005			REC0586798	REC5000611	
9.9 ELEC.	2	1995-2003			REC0586798	REC0763770	REC0583387
10	2	1994			REC0586798	REC5000611	REC0583387
10	2	1996-98		✓		REC0584954	
14	2	1988			REC0586697	REC5000611	REC0583387
14	2	1989-90			REC300-26084	REC5000611	REC0583387
15	2	1983-84			REC0582452	REC5000611	
15	2	1988			REC0586697	REC5000611	REC0583387
15	2	1989-91			REC300-26084	REC5000611	REC0583387
15	2	1992			REC300-26085	REC5000611	REC0583387
15	2	1993				REC0763770	
15	2	1994			REC0586798	REC5000611	
15	2	1995-2000			REC0586798	REC5000611	REC0583387
15 ELEC.	2	1996-97			REC0586798	REC0763770	
15	2	1996-2000		✓		REC0584954	REC32800-95D01
20	2	1982-84			REC0582452	REC5000611	REC0583387
20	2	1985-88			REC0586697	REC5000611	REC0583387
20	2	1989-92			REC300-26085	REC5000611	REC0583387
20	2	1993-2000			REC5001344	REC5000611	REC0583387
25	2	1982-84			REC0582452	REC5000611	REC0583387
25	2	1985-88			REC0586697	REC5000611	REC0583387
25	2	1989-92			REC300-26085	REC5000611	REC0583387
25	2	1993-2005			REC5001344	REC5000611	REC0583387
25	3	1994-95			REC5004532	REC0763763	
28	2	1985-88			REC0586697	REC5000611	REC0583387
28	2	1989-92			REC300-26085	REC5000611	REC0583387
28	2	1993-98			REC5001344	REC5000611	REC0583387
30	2	1984			REC0582452	REC5000611	REC0583387
30	2	1985-88			REC0586697	REC5000611	REC0583387
30	2	1989-92			REC300-26085	REC5000611	REC0583387
30	2	1993-2005			REC5001344	REC5000611	REC0583387
35	2	1982-84			REC0582452	REC5000611	REC0583387
35	2	1985-88			REC0586697	REC5000611	REC0583387
35	2	1989-92			REC300-26085	REC5000611	REC0583387
35	2	1992-93			REC0175316	REC0763763	REC0763808
35	2	1993-97			REC5001344	REC5000611	REC0583387
35	2	1993-95			REC0175316	REC0763763	REC0763808
35	2	1996-97			REC0175316	REC0763763	REC0763808
40	2	1985-88			REC0586697	REC5000611	REC0583387
40	2	1989-92			REC300-26085	REC5000611	REC0583387
40	2	1992			REC0175316	REC0763763	REC0763808
40	2	1993			REC5001344	REC5000611	REC0583387
40	2	1993-95			REC0175316	REC0763763	REC0763808
40	2	1996-97			REC5001344	REC5000611	REC0583387
40	2	1996-97			REC0175316	REC0763763	REC0763808
40 MAN.	2	1985			REC0586695	REC5000611	REC0583387
40 COM	2	1993-97			REC0586695	REC5000611	REC0583387
40 MAN.	2	2000-05			REC5001344	REC5000611	REC0583387
40 ELEC.	2	2000-05			REC0175316	REC0763763	REC0763808
45 COM	2	1985			REC0586695	REC5000611	REC0583387
45	2	1986-90			REC0586697	REC5000611	REC0583387
45 COM	2	1989-91			REC300-26085	REC5000611	REC0583387
45 COM	2	1992-2000			REC0586695	REC5000611	REC0583387
48	2	1987-88			REC0586697	REC5000611	REC0583387
48	2	1989-93			REC300-26085	REC5000611	REC0583387
48	2	1994-96			REC5001344	REC5000611	REC0583387
50	2	1971-75			REC0764708		
50 ELEC.	2	1979-83			REC0582452		
50	2	1979-83			REC0582452	REC5000611	REC0583387
50	2	1985-88			REC0586697	REC5000611	REC0583387
50	2	1989-92			REC300-26085	REC5000611	REC0583387
50 TE-S	2	1992			REC0175316	REC0763763	REC0763808
50	2	1993-95			REC0175316	REC0763763	
50 MAN.	2	1993-95			REC5001344	REC5000611	REC0583387
50	3	1996-98			REC5004532	REC0763763	REC0763773

	CYL	CAJA NEGRA POWER PACK CENTRALINA BOTIER ELECTRONIQUE		STARTOR	TRIGGER
		2T STROKES	4T STROKES		
50 MAN.	2	1997-99	REC5001344	REC5000611	REC0583387
50 ELEC ST	2	1997-99	REC0175316	REC0763763	REC0763808
50 MAN.	2	1998-99	REC5001344	REC5000611	REC0583387
55	2	1979-82	REC0582452		
55	2	1988	REC0586697	REC5000611	REC0583387
55 COM	2	1983-84	REC0582901	REC5000611	REC0583387
55 COM	2	1985	REC0586695	REC5000611	REC0583387
55 COM	2	1986-87	REC0586697	REC5000611	REC0583387
55	2	1989-91	REC300-26085	REC5000611	REC0583387
55	2	1992-2000	REC0586695	REC5000611	REC0583387
60	2	1985	REC0586697	REC5000611	REC0583387
60	3	1986-89	REC0582115	REC0583724	
60	3	1989-91	REC0583748		
60	3	1992	REC0583748	REC0763763	
60	3	1993-2001	REC5004532	REC0763763	REC0763773
65 COM	3	1986-88	REC0583320	REC0583724	
65 COM	3	1989-95	REC0583748		
65 COM ELEC	3	1993-94	REC5004532	REC0763763	REC0763773
65 COM VRO	3	1995	REC0583748		
65 COM	3	1996-2000	REC0585274	REC0763763	
70	3	1986-88	REC0582115	REC0583724	
70	3	1989-91	REC0583748		
70	3	1992	REC0583748	REC0763763	
70	3	1993-2001	REC5004532	REC0763763	REC0763773
75	3	1986-88	REC0582115	REC0583724	
85	4	1973-77	REC0582056		
85	4	1978-83	REC0582125	REC0583672	
85 TJL	4	1991-95	REC0584028	REC0763767	REC0763776
85 TTL/TRIM	4	1994	REC584030	REC0763767	REC0763776
85 TTL	4	1995	REC0584028	REC0763767	REC0763776
88	4	1988	REC0582262	REC0763767	
88	4	1989-93	REC0584028	REC0763767	REC0763776
88	4	1994	REC584030	REC0763767	REC0763776
88	4	1994-96	REC0584028	REC0763767	REC0763776
90, 6, 10 Amp.	4	1984	REC0582125	REC0583672	
90	4	1989-93	REC0584028	REC0763767	REC0763776
90	4	1994-95	REC584030	REC0763767	REC0763776
90 20 / 25IN	4	1996-97	REC0584028	REC0763767	REC0763776
90 60° Deg.	4	1996-2006	REC0765386	REC0763760	REC0586343
100	4	1990-93	REC0584028	REC0763767	REC0763776
100	4	1994	REC584030	REC0763767	REC0763776
100 COM	4	1989-97	REC584030	REC0763767	REC0763776
100	4	1989	REC0584028	REC0763767	REC0763776
100 COM, 105	4	2000-06	REC0765386	REC0763760	REC0586343
112 20, 25 IN	4	1994-96	REC0584028	REC0763767	REC0763776
115 6, 10 Amp.	4	1978-84	REC0582125	REC0583672	
115 No Not Trim	4	1985		REC0583672	
115	4	1990-93	REC0584028	REC0763767	REC0763776
115	4	1994	REC584030	REC0763767	REC0763776
115	4	1995-96	REC0584028	REC0763767	REC0763776
115 60° Deg.	4	1995-2006	REC0765386	REC0763760	REC0586343
115 20,25 IN	4	1997	REC0584028	REC0763767	REC0763776
120 35 Amp.	4	1984-87	REC0582125		
120	4	1986-87	REC0582262		REC0763776
120 Looper	4	1988-90	REC0584041	REC0763769	REC0763782
120 35 Amp.	4	1988-95	REC0584041	REC0584288	REC0763782
120 10 Amp.	4	1992-94	REC0584041	REC0763769	REC0763782
125	4	1991-94	REC0584041	REC0763769	REC0763782
125 COM ELEC.	4	1989-95	REC0584041	REC0763769	REC0763782
130 35 Amp.	4	1988-2000	REC0584041	REC0584288	REC0763782
130	4	1995-2000	REC0584041	REC0763769	REC0763782
135	4	1973-77	REC0582056		
135	4	2001	REC0584041	REC0763769	REC0763782
140	4	1977	REC0582056		
140	4	1978-84	REC0582125	REC0583672	
140 10 Amp.	4	1984	REC0582125	REC0583672	
140 Looper	4	1988-95	REC0584041	REC0763769	REC0763782
150	6	19978	REC0582057		
150	6	1979-84	REC0582642	REC0583672	
150 35 Amp.	6	1984	REC0582642	REC0583668	
150	6	1985		REC0583672	
150 35 Amp.	6	1985		REC0583668	
150 TL/TX	6	1986-87	REC0583114	REC0583672	
150 ST	6	1986-88	REC0583114		
150 SL/ST	6	1989-90	REC0583865	REC0763764	
150 ST	6	1990	REC0583865	REC0763764	
150 60°	6	1991	REC0584985	REC0583415	REC0586343
150 SL/ST	6	1991	REC0583865	REC0763764	REC0586343
150	6	1992-2006	REC0584985	REC0763759	REC0586343
155 COM 35 Amp.	6	1984	REC0582642	REC0583668	
155 COM	6	1984		REC0583668	
155 COM	6	1986-88		REC0583668	
155 COM	6	1989-92	REC0583865	REC0763764	
175	6	1977-78	REC0582057		
175	6	1979-83	REC0582642	REC0583672	

🔧	CYL		2T	4T	CAJA NEGRA POWER PACK CENTRALINA BOITIER ELECTRONIQUE	STARTOR	TRIGGER
			STROKES	STROKES			
175	6	1985-88				REC0583668	
175	6	1989-90			REC0583865	REC0763764	
175GL/EK/EL/NX	6	1991-2006			REC0584985	REC0763759	REC0586343
175	6	1992-98			REC0584985	REC0763759	REC0586343
185	6	1979-84			REC0582642	REC0583672	
185	6	1985				REC0583668	
185	6	1990-92			REC0586667	REC0763765	REC763775
200	6	1976-78			REC0582057		
200	6	1979-83			REC0582642	REC0583672	
200	6	1986-87				REC0583670	
200	6	1988-92			REC0586667	REC0763765	REC763775
200	6	1993-2000			REC0586661		REC763775
225	6	1988-1992			REC0586667	REC0763765	REC763775
225	6	1993-2000			REC0586661	REC0763779	REC763775
235	6	1978			REC0582057		
235	6	1979-84			REC0582642	REC0583672	
235 35 Amp.	6	1984			REC0582642	REC0583668	
235 10 Amp.	6	1985				REC0583672	
235 35 Amp.	6	1985				REC0583668	
275 3.6L	8	1986-87			REC0582262	REC0583670	
250	8	1993-95			REC0763803	REC0763779	
250	8	1997			REC0763803	REC0763779	
300 3.6L	8	1986-87			REC0582262	REC0583670	
300	8	1993-95			REC0763803	REC0763765	
2.5L, 2.6L	6	1982			REC0582642	REC0583672	
1.6L	8	1983			REC0582125	REC0583672	
2.6L 35 Amp.	6	1983			REC0582642	REC0583668	
1.6L S V4	8	1984			REC0582125	REC0583672	
2.5L, 2.6L	6	1984				REC0583668	
1.6L	4	1985				REC0583672	
2.5L, 2.6L	6	1985				REC0583668	
2.6L 35 Amp.	6	1986			REC0583114	REC0583668	
1.8L	4	1987			REC0582262		
2.7L	6	1987				REC0583668	
3.6L	8	1987			REC0582262	REC0583670	
1.6L	4	1988-90			REC0582262	REC0763767	REC0763776
2.0L	4	1988-90			REC0584041	REC0584288	REC0763782
3.0L	6	1988-90			REC0586667	REC0763765	REC763775
4.0L	8	1989-90			REC0584035	REC0763765	

DESCONECTORES DE SEGURIDAD

CUT OFF SWITCHES

CHIAVETTA DI SICUREZZA

COUPE CIRCUIT DE SECURITE

REF	OEM
MP28870	585134



REF	OEM
REC37830-89E03	5030225 5032047



REF	OEM
REC37820-92E03	5031481



KITS
Interrupor de encendido para todo tipo de motores fueraborda o intraborda

KITS
Emergency and stop switch for inboard or outboards.

KIT
Interruttore di accensione per tutti i tipi di motori fuoribordo o entro bordo.

KITS
Coupe circuit de sécurité pour moteur inboard ou hors-bord

REF KIT	CUERDA WIRE CORDA CORDON	
REC40970	REC40990	1

RECMAR



REF KIT	CUERDA WIRE CORDA CORDON	
GS11290	GS11291	1

GOLDENSHIP



REF KIT	
GS11292	1

GOLDENSHIP



REF	
GS11294	J/E, OMC, Mercury, Yamaha, Honda, Suzuki, Tohatsu.
	1

GOLDENSHIP



TRIM, TILT & POWER TRIM

INSTALACIÓN ELÉCTRICA

WIRING HARNESS

INSTALLAZIONE ELETTRICA

INSTALLATION ELECTRIQUE

KIT CONVERSIÓN
Sustituye de 2 a 3 cables.

CONVERSION KIT
Converts 3-wire Tilt and Trim motors to 2-Wire design

KIT CONVERSIONE
Sustituisce da 2 a 3 cavi.

KIT DE CONVERSION DE 3 A 2 FILS

REF	OEM
PH200-WH01	84-819514T26 84-826075A2 84-826802A4



MOTOR TRIM COMPLETO

COMPLETE TRIM ASSEMBLY

MOTORINO TRIM COMPLETO

MOTEUR DE TRIM COMPLET

REF	OEM				2T STROKES	4T STROKES
PH200-T020	387277 582048 582155 584107 582047 777784	3, 4, 6 Cyl (1981+)	3	3	✓	



REF	OEM				2T STROKES	4T STROKES
PH200-T014	391264 393259 393988 394176 983019	3, 4, 6 Et 8 Cyl (1981+)	3	2	✓	



REF	OEM				2T STROKES	4T STROKES
PH200-T072	5005822 5005831 5005875 5006479	J/E 15- 90 HP (2004+)		4	2	✓



REF	OEM				2T STROKES	4T STROKES
PH200-T022	433226	40, 48, 50 HP (1989+)		4	2	✓



REF	OEM				2T STROKES	4T STROKES
PH200-T021	437801 435532	Heavy Duty, J Suffix 25, 40, 48, 50 HP (1992+) Hollow hex. shaft.		4	2	✓



REF	OEM				2T STROKES	4T STROKES
REC38100-96J00	5033838 5034526 5034627 5035113 5035513	J60 / 70 / 90 / 115 / 140 / 200 / 225 BJ60 / 70 / 90 / 115 / 140 / 220 / 225 (2003-06)		4	2	✓



REF	OEM				2T STROKES	4T STROKES
PH200-T046	5032670	E40 / J40 / BJ40 E50 J50 / BJ50 (2001-04)		4	2	✓



REF	OEM				2T STROKES	4T STROKES
PH200-T005	434495 434496 438529 5005374 438531	60, 70, 90, 115, 150, 175, 200, 225 HP (1991+) 120 - 140 HP (1991-94) 50 HP (3 cyl) 60 JP V4 - 130 HP		4	2	✓



REF	OEM				2T STROKES	4T STROKES
PH200-T062	5036081 5032670 5031482	J/BJ 40, 50 (1999-06)		4	2	✓



new



REF	OEM				2T STROKES	4T STROKES
REC38100-99E01-0EP	5030829 5030828 5030830 5031166	J70		4	2	✓

REF	OEM				2T STROKES	4T STROKES
REC38100-87J00	5031482	E40 / E50 (1999-06)		4	2	✓



REF	OEM				2T STROKES	4T STROKES
PH200-T061	5006319 5005838 5005817	E75, E90, E115, E130 (2004+) J40, J50 (2005) E-TEC	4	2	✓	



REF	OEM				2T STROKES	4T STROKES
REC435548	435548 983446 985237	V6 Commercial (1993) V8 (1993+)			3	2 ✓



REF	OEM				2T STROKES	4T STROKES
PH200-T004	439937 5005254 438786	75-250 HP (1998+)	4	2		



REF	OEM		2T STROKES	4T STROKES
REC173944	173944 172588	Motores pequeños Small outboards Motori piccoli Petits Moteurs	✓	

Para bomba OMC 173946 OMC pump 173946 Pompa OMC 173946 Pompe OMC 173946



POWER TRIM COMPLETO POWER TRIM ASSEMBLY POWER TRIM COMPLETO POWER TRIM COMPLET

REF	OEM		2T STROKES	4T STROKES
REC18-6865	5005114	3 RAM 115-225 HP No / Not 250 Et 300 HP	✓	✓



SENSOR DE TRIM TRIM SENSOR SENSORE TRIM SONDE DE TRIM

REF	OEM		2T STROKES	4T STROKES
REC34801-93J03	5035099 5036277	J, BJ200HP J, BJ225 HP		✓



new

REF	OEM		2T STROKES	4T STROKES
REC34801-99E04	5036054 5031474 5031116	J, BJ40 J, BJ50 J, BJ60 J, BJ70 J30 J, BJ90 J, BJ115 J, BJ140		✓



new

RELÉ DE TRIM TRIM RELAY RELE TRIM RELAIS DE TRIM

REF	OEM		2T STROKES	4T STROKES
REC38410-93J12	5036701 5034606		40- 300 HP	✓



new

TAPON PISTÓN TRIM

PLUG PISTON TRIM

TAPPO PISTONE TRIM

BOUCHON VERIN DE TRIM

REF	OEM	
REC48630-94900	5030870 J70	



new

REF	OEM	
REC48630-92J00	5033935 J, BJ140 HP	



new

EXTRACTOR TAPONES DE TRIM

TRIM PLUGS EXTRACTOR

ESTRATTORE PER TAPPI DI TRIM

KIT EXTRACTEUR

REF	
RECTOOLTRIMKIT	RECTOOLTRIM1 + RECTOOLTRIM2 + RECTOOLTRIM3



REF				A
RECTOOLTRIM1	1/2"	+ RECPIN4	+ RECPIN4.5	38 mm
RECTOOLTRIM2	1/2"	+ RECPIN4	+ RECPIN4.5	32 mm
RECTOOLTRIM3	1/2"	+ RECPIN6		35 mm

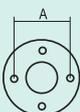

	TRIM PISTON	TILT PISTON
Evinrude E-Series E115 to E225 (1998+)	RECTOOLTRIM2	RECTOOLTRIM3
Evinrude E-TEC 115 to 300Hp	RECTOOLTRIM2	RECTOOLTRIM3
Jhonson J-Series J115 to J250 (1998-06)	RECTOOLTRIM2	RECTOOLTRIM3

KITS DE RECAMBIO

Los pines de repuesto no tienen garantía.

SPARE KITS

Replacement pins are not guaranteed.

KIT DI RICAMBIO

I perni di ricambio non sono garantiti.

KIT DE RECHANGE

Les pines de remplacement ne sont pas garanties

REF	
RECPIN4	3 PIN x 4 mm
RECPIN4.5	3 PIN x 4.5 mm
RECPIN6	3 PIN x 6 mm



REF STA84154



REF STA84104

PLATINOS Y CONDESADORES

POINTS & CONDENSERS

PUNTINE E CONDENSATORE

VIS PLATINEES ET CONDENSATEUR

CONDENSADORES

CONDENSERS

CONDENSATORI

CONDENSATEUR

REF	OEM
REC0580321	580321



REF	OEM
REC0581419	581419



REF	OEM
REC0580256	580256



PLATINOS		POINTS		PUNTINE		VIS PLATINEES	
REF	OEM			REF	OEM		
REC0581207	581207			REC0580148	580148		
REF	OEM						
REC0580290	580290						

KITS

REF	PLATINO POINT PUNTINO VIS PLATINEE	CONDENSADOR CONDENSER CONDENSATORE CONDENSATEUR	
REC0172522	REC0580148	REC0580321	X2
REC0172523	REC0580148	REC0581419	X2
REC0172806	REC0581207	REC0581419	X2
REC0172525	REC0580290	REC0580256	X2

REC0172522

REC0172523

REC0172806

REC0172525

GUÍA PLATINOS Y CONDENSADORES					CONDENSERS & POINTS GUIDE					GUIDA CONDENSATORI E PUNTINE					GUIDE CONDENSATEUR ET VIS PLATINEES				
REF		PLATINO POINT PUNTINO VIS PLATINEE	CONDENSADOR CONDENSER CONDENSATORE CONDENSATEUR	KIT	REF		PLATINO POINT PUNTINO VIS PLATINEE	CONDENSADOR CONDENSER CONDENSATORE CONDENSATEUR	KIT	REF		PLATINO POINT PUNTINO VIS PLATINEE	CONDENSADOR CONDENSER CONDENSATORE CONDENSATEUR	KIT	REF		PLATINO POINT PUNTINO VIS PLATINEE	CONDENSADOR CONDENSER CONDENSATORE CONDENSATEUR	KIT
3	1950-68	REC0580148	REC0580321	REC0172522	30	1956	REC0580148	REC0580321	REC0172522	30	1956	REC0580148	REC0580321	REC0172522	30	1956	REC0580148	REC0580321	REC0172522
4	1969-76	REC0580148	REC0580321	REC0172522	33	1965-70	REC0580148	REC0581419	REC0172523	33	1965-70	REC0580148	REC0581419	REC0172523	33	1965-70	REC0580148	REC0581419	REC0172523
4	1981-90	REC0580148	REC0580321	REC0172522	35	1957-61	REC0580148	REC0580321	REC0172522	35	1957-61	REC0580148	REC0580321	REC0172522	35	1957-61	REC0580148	REC0580321	REC0172522
4.5	1981	REC0581207	REC0581419	REC0172806	35	1976	REC0580148	REC0581419	REC0172523	35	1976	REC0580148	REC0581419	REC0172523	35	1976	REC0580148	REC0581419	REC0172523
5	1950-68	REC0580148	REC0580321	REC0172522	40	1951-61	REC0581207	REC0580321	REC0172522	40	1951-61	REC0581207	REC0580321	REC0172522	40	1951-61	REC0581207	REC0580321	REC0172522
5.5	1954-64	REC0580148	REC0580321	REC0172522	40	1962-73	REC0580148	REC0581419	REC0172523	40	1962-73	REC0580148	REC0581419	REC0172523	40	1962-73	REC0580148	REC0581419	REC0172523
6	1951-76	REC0580148	REC0580321	REC0172522	40	1974-83	REC0580148	REC0581419	REC0172523	40	1974-83	REC0580148	REC0581419	REC0172523	40	1974-83	REC0580148	REC0581419	REC0172523
7.5	1950-68	REC0580148	REC0580321	REC0172522	40C	1981-83	REC0581207	REC0581419	REC0172806	40C	1981-83	REC0581207	REC0581419	REC0172806	40C	1981-83	REC0581207	REC0581419	REC0172806
9.5	1964-73	REC0580148	REC0580321	REC0172522	45	1958-59	REC0580290	REC0580256	REC0172525	45	1958-59	REC0580290	REC0580256	REC0172525	45	1958-59	REC0580290	REC0580256	REC0172525
9.5	1974-76	REC0581207	REC0581419	REC0172806	50	1958-59	REC0580290	REC0580256	REC0172525	50	1958-59	REC0580290	REC0580256	REC0172525	50	1958-59	REC0580290	REC0580256	REC0172525
9.9	1974-76	REC0580290	REC0581419	REC0172806	60	1964-67	REC0580290	REC0580256	REC0172525	60	1964-67	REC0580290	REC0580256	REC0172525	60	1964-67	REC0580290	REC0580256	REC0172525
10	1950-68	REC0580148	REC0580321	REC0172522	75	1960-65	REC0580290	REC0580256	REC0172525	75	1960-65	REC0580290	REC0580256	REC0172525	75	1960-65	REC0580290	REC0580256	REC0172525
15	1974-76	REC0581207	REC0581419	REC0172806	80	1966-67	REC0580290	REC0580256	REC0172525	80	1966-67	REC0580290	REC0580256	REC0172525	80	1966-67	REC0580290	REC0580256	REC0172525
15	1950-68	REC0580148	REC0580321	REC0172522	90	1964-75	REC0580290	REC0580256	REC0172525	90	1964-75	REC0580290	REC0580256	REC0172525	90	1964-75	REC0580290	REC0580256	REC0172525
18	1957-61	REC0580148	REC0580321	REC0172522	100	1966	REC0580290	REC0580256	REC0172525	100	1966	REC0580290	REC0580256	REC0172525	100	1966	REC0580290	REC0580256	REC0172525
18	1962-73	REC0580148	REC0581419	REC0172523															
20	1957-76	REC0580148	REC0581419	REC0172523															
25	1969-76	REC0580148	REC0581419	REC0172523															
28	1962-64	REC0580148	REC0581419	REC0172523															

SISTEMA DE GOBIERNO STEERING SYSTEM

SISTEMA DI GUIDA SYSTÈME DE COMMANDE

MANDOS DE CONTROL

ENGINE CONTROLS

COMANDI DI
CONTROLLO

BOITIER DE COMMANDE

MANDO LATERAL

SIDE CONTROL

COMANDO LATERALE

BOITIER LATERAL

REF	OEM	TRIM			BRP
REC5006180	5006180	✓	✓		1996+



new

REF	OEM	TRIM			BRP
REC5006181	5006181		✓		1974+



new

MANDO PARA CONSOLA

CONSOLE CONTROL

COMANDO PER
CONSOLLA

BOITIER POUR CONSOLE

REF	OEM	TRIM		
REC5006182	5006182	✓		BRP 1996+
REC5006184	5006184	✓		BRP 1996+



REC5006182

REC5006184

REF	OEM	TRIM		
REC5006186	5006186	✓	✓	BRP 1996+



INTERRUPTORES
Y CABLES

SWITCHS & CABLES

INTERRUTTORI E CAVI

INTERRUPTEUR
ET CÂBLES

INTERRUPTOR MANDO

CONTROL SWITCH

INTERRUTTORI
CONTROLLO

INTERRUPTEUR DE
CONTROLE

REF	OEM
REC0176408	176408

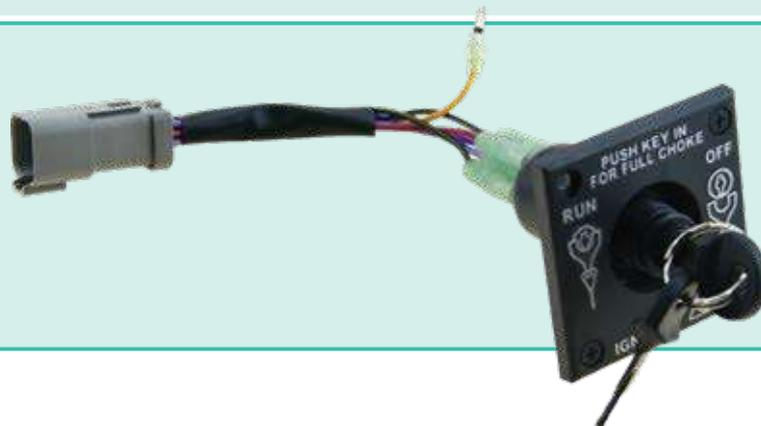

ARNÉS	ARNES	CAVI	FAISCEAU ELECTRIQUE
-------	-------	------	---------------------

REF	OEM	
REC0176340	176340	10 FT
REC0176342	176342	20 FT



EXTENSIÓN DE ARNÉS	ARNES EXTENSION	ESTENSIONE	RALLONGE FAISCEAU
--------------------	-----------------	------------	-------------------

REF	OEM	
REC0176333	176333	5 FT
REC0176335	176335	20 FT



CABLES DE CONTROL	CONTROL CABLE	CAVI COMANDO	CÂBLES DE COMMANDE
-------------------	---------------	--------------	--------------------

REF	OEM	
PREMC30506	173106	6' / 1,80 m
PREMC30507	173107	7' / 2,10 m
PREMC30508	173105	8' / 2,45 m
PREMC30509	173109	9' / 2,75 m
PREMC30510	173110	10' / 3,05 m
PREMC30511	173111	11' / 3,35 m
PREMC30512	173112	12' / 3,65 m
PREMC30513	173113	13' / 3,95 m
PREMC30514	173114	14' / 4,25 m
PREMC30515	173115	15' / 4,60 m
PREMC30516	173116	16' / 4,90 m
PREMC30517	173117	17' / 5,20 m
PREMC30518	173118	18' / 5,50 m
PREMC30519	173119	19' / 5,80 m
PREMC30520	173120	20' / 6,10 m
PREMC30521	173121	21' / 6,40 m
PREMC30522	173122	22' / 6,70 m
PREMC30523	173123	23' / 7,00 m
PREMC30524	173124	24' / 7,30 m



CABLES DE ACELERADOR	THROTTLE CABLE	CAVO ACCELERATORE	CÂBLES D'ACELERATION
----------------------	----------------	-------------------	----------------------

REF	OEM	
REC0397004	397004	6, 8 (1968-90)
REC0433325	433325	8
REC0435230	435230	15 (1989+)
REC0500581	500581 396161	20, 25, 30 (1986+)
REC0398243	398243	25 (1989+)
REC0439542	439542	35



SISTEMA DE REFRIGERACIÓN COOLING SYSTEM

SISTEMA DI RAFFREDDAMENTO SYSTÈME DE REFROIDISSEMENT

LÍQUIDO INHIBIDOR DE LA CORROSIÓN

SALT OFF

Diseñado especialmente para eliminar sedimentos de sal de cualquier superficie pintada, de metal, fibra de vidrio, vinilo, caucho, cristal o plástico. Es el método más eficaz para proteger los motores, los aparejos de pesca... Genera una capa de polímeros que evita futuras sedimentaciones.

It is specifically formulated to quickly and effectively remove salt deposits from metal, fiberglass, plastic or painted surfaces. It contains special polymers that bond to the treated surface to help prevent the formation of future deposits.

LIQUIDO INIBITORE DELLA CORROSIONE

SALT OFF

Appositamente progettato per rimuovere depositi di sale da qualsiasi superficie verniciata, metallo, fibra di vetro, vinile, gomma, vetro o plastica. È il metodo più efficace per proteggere motori, attrezzi da pesca... Genera uno strato di polimeri che impedisce la futura sedimentazione.

La protection SALT OFF est formulé pour éliminer les dépôts de sel sur toutes les surfaces marines. Utilisable pour le rinçage des moteurs hors bord et inboard et les embases. Il laisse un film de protection spécial pour prévenir des attaques futures du sel.

new



REF
STA94100

Star brite



REF	Image	Volume
STA93900		3,78 L
STA93922		650 ml
STA93932		1 L

STA93900



STA93932



STA93922



P
32



P
39

JOHNSON EVINRUDE

RECAMBIOS
MARINOS

TERMOSTATO

THERMOSTAT

TERMOSTATO

THERMOSTAT

DESPIECES DE TERMOSTATO

THERMOSTAT ASSEMBLIES

ESPLOSO TERMOSTATO

PIÈCES DE THERMOSTAT

2 CYL 25/35 HP (1996-01)

	REF	OEM			
1		308458	ARO	O-RING	O-RING
2	REC336185	336185	ARANDELA	WASHER	RONDELLA
3		336211	MUELLE	SPRING	MOLLA
4	REC878904	436195	TERMOSTATO	THERMOSTAT	TERMOSTATO
5		336179	MUELLE	SPRING	MOLLA
6	REC301967	301967	ARO	O-RING	O-RING

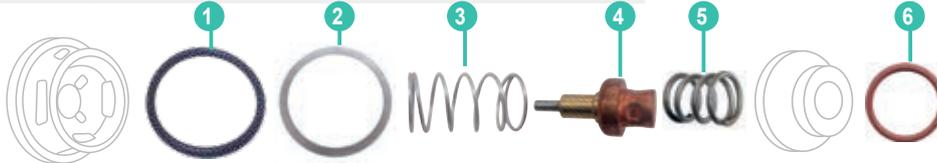

2, 3 CYL, V4 LOOPCHARGED (1992-00)

	REF	OEM			
1	REC343141	343141	TAPA	COVER	COPERCHIO
2	REC329830	329830	JUNTA	GASKET	GUARNIZIONE
3	REC336185	336185	ARANDELA	WASHER	RONDELLA
4		336211	MUELLE 60-70 HP (1993) y V4 Con tapa de termostato 339207	SPRING60-70 HP (1993) Et V4 use with cover 339207	MOLLA 60-70 HP (1993) e V4 usare con coperchio 339207
		342421	MUELLE 40-70 HP (1995-96) y V4	SPRING 40-70 HP (1995-96) Et V4	MOLLA 40-70 HP (1995-96) e V4
		343115	MUELLE 40-70 HP (1997-98)	SPRING 40-70 HP (1997-98)	MOLLA 40-70 HP (1997-98)
		343020	MUELLE V4	SPRING V4	MOLLA V4
5	REC435957	435957	DIAPHRAGMA	DIAPHRAGM	MEMBRANA
6	REC878904	436195	TERMOSTATO	THERMOSTAT	TERMOSTATO
7		336179	MUELLE	SPRING	MOLLA
8	REC336178	336178	CAMISA TERMOSTATO	THERMOSTAT SLEEVE	SEDE TERMOSTATO



V4 CROSSFLOW

	REF	OEM			
1	REC332369	332369	JUNTA	GASKET	GUARNIZIONE
2	REC321692	321692	GRUESO	GROMMET	SPESSORE
3	REC318395	318395	VÁLVULA	VALVE	VALVOLA
4	REC6F5-12411-03	5005440	TERMOSTATO	THERMOSTAT	TERMOSTATO
5	REC321932	321932	JUNTA	GASKET	GUARNIZIONE
6	REC317245	317245	MUELLE	SPRING	MOLLA
7	REC318373	318373	JUNTA (1973-77)	GASKET (1973-77)	GUARNIZIONE (1973-77)
	REC342513	342513	JUNTA (1978-97)	GASKET (1978-97)	GUARNIZIONE (1978-97)

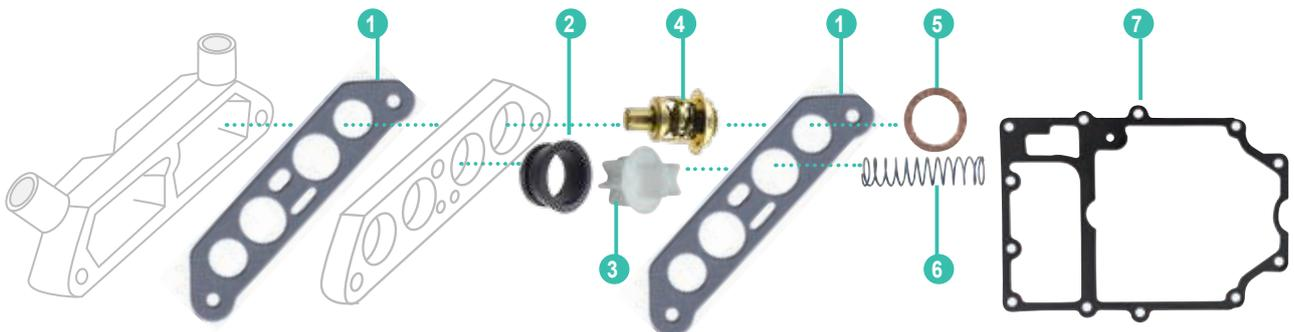

V6 CROSSFLOW

	REF	OEM				
1	REC321184	321184	JUNTA	GASKET	GUARNIZIONE	JOINT
2	REC317245	317245	MUELLE	SPRING	MOLLA	RESSORT
3	REC6F5-12411-03	5005440	TERMOSTATO	THERMOSTAT	TERMOSTATO	THERMOSTAT
4	REC27-62386001	310058	JUNTA	GASKET	GUARNIZIONE	JOINT
5	REC306643	306643	TORNILLO	SCREW	VITE	VIS
6	REC321120	321120	TAPA CIERRE	PLATE SEAL	COPERCHIO	COUVERCLE
7	REC321221	321221	DIAFRAGMA	DIAPHRAGM	MEMBARNA	DIAPHRAGME
8	REC321027	321027	VÁLVULA	VALVE	VALVOLA	SOUPAPE
9	REC320880	320880	ASIENTO VÁLVULA	VALVE SEAT	SEDE VALVOLA	SIEGE DE SOUPAPE
10	REC321222	321222	TAPA VÁLVULA	VALVE CUP	COPERCHIO VALVOLA	COUVERCLE

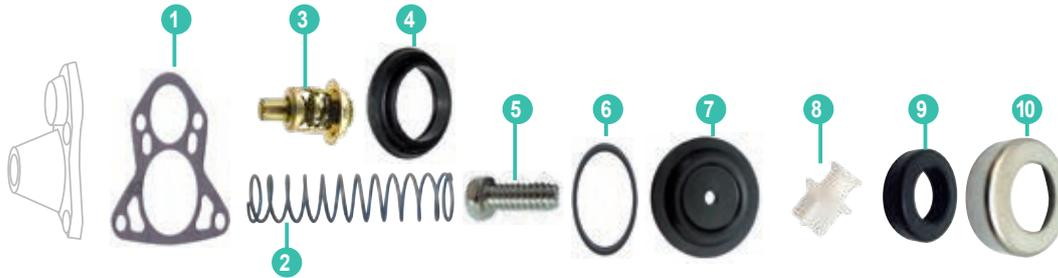

TERMOSTATO

THERMOSTAT

TERMOSTATO

THERMOSTAT

REF	OEM		°C
REC396987	396987	3 Cyl (-1985)	61°



REF	OEM		°C
REC434137	434137	3 Cyl, (1986-91) V4 Loopcharged, V8	61°



REF	OEM		°C
REC5001036	5001036	V6 200-250 Ficht Flujo alto Higher flow Flusso alto Haut débit	56°



REF	OEM		°C
REC878904	436195	9.9, 15, 40, 48, 50 HP 3 Cyl, V4	61°



REF	OEM		°C
REC6F5-12411-03	434841 5005440	6-55 HP, V4, V6 Crossflow	61°



REF	OEM		°C
REC394411	394411	Vernatherm, 65, 85, 100, 115, 135 HP (1971-90)	61°



REF	OEM		°C
REC435491	435491	V4, 90-115 HP (1995+) V6, 150-175 HP (1991+)	61°



REF	OEM		°C
REC437090	437090	V6 OFFSHORE Acero Inox. Flujo bajo. Stainles Steel. Lower flow. Acciaio inox. Flusso basso. Acier inox. Faible débit	56°



REF	OEM		2T STROKES	4T STROKES	°C
REC17670-94J01	5036226	J/BJ25		✓	60°



REF	OEM		2T STROKES	4T STROKES	°C
REC17670-87J00	50317562	40 - 70 HP		✓	72°



REF	OEM		2T STROKES	4T STROKES	°C
REC17670-91J01	5033385	2, 4, 5 hp		✓	50°



REF	OEM		2T STROKES	4T STROKES	°C
REC17670-90J10	5033722	J/BJ 90 - 225 HP		✓	71°



REF	OEM		2T STROKES	4T STROKES	°C
REC17670-93962	5030742 5031175 5030742	J/BJ 70-140 HP		✓	50°



REF	OEM		2T STROKES	4T STROKES	°C
REC67F-12411-01	5033721	J/BJ140		✓	60°



REF	OEM		2T STROKES	4T STROKES	°C
REC17670-94402	5031758	10 - 70 HP		✓	60°



KITS TERMOSTATO THERMOSTATO KITS KIT TERMOSTATO KIT THERMOSTAT

REF		°C	REF	OEM	TERMOSTATO	THERMOSTAT	TERMOSTATO	THERMOSTAT
REC13450	3 CYL	90°	REC396987		TERMOSTATO	THERMOSTAT	TERMOSTATO	THERMOSTAT
			REC332108	332108	JUNTA	GASKET	GUARNIZIONE	JOINT
			REC3852120		JUNTA	GASKET	GUARNIZIONE	JOINT



REF		°C	REF	OEM	TERMOSTATO	THERMOSTAT	TERMOSTATO	THERMOSTAT
REC13350	6-55 HP V4, V6	90°	REC6F5-12411-03	434841	TERMOSTATO	THERMOSTAT	TERMOSTATO	THERMOSTAT
			REC27-62386001	332108	JUNTA	GASKET	GUARNIZIONE	JOINT



REF		°C	REF	OEM				
REC13270	V4 Crossflow	143°	REC6F5-12411-03	434841	TERMOSTATO	THERMOSTAT	TERMOSTATO	THERMOSTAT
			REC318395	318395	TERMOSTATO	THERMOSTAT	TERMOSTATO	THERMOSTAT
			REC321932	321932	JUNTA	GASKET	GUARNIZIONE	JOINT
			REC332369	332369	JUNTA	GASKET	GUARNIZIONE	JOINT
			REC317245	317245	VÁLVULA	VALVE	VALVOLA	SOUPAPE
			REC321692	321692	MUELLE	SPRING	MOLLA	RESSORT
			REC332369	332369	GRUESO	GROMMET	SPESSORE	CALE



REF		°C	REF	OEM				
REC435597			REC435491	435491	TERMOSTATO	THERMOSTAT	TERMOSTATO	THERMOSTAT
			REC338632	338632	TAPA	COVER	COPERCHIO	COUVERCLE
			REC331188	331188	TÓRICA	O-RING	O-RING	TORIQUE
			337067	MUELLE	SPRING	MOLLA	RESSORT	



REF		°C	REF	OEM				
REC13290	V4-V6	143° 60°	REC435491	435491	TERMOSTATO	THERMOSTAT	TERMOSTATO	THERMOSTAT
			REC338632	338632	TAPA	COVER	COPERCHIO	COUVERCLE
			REC331188	331188	TÓRICA	O-RING	O-RING	JOINT TO-RIQUE
			337067	MUELLE	SPRING	MOLLA	RESSORT	
			REC343105	343105	CAMISA	SLEEVE	CAMICIA	BAGUE DE THERMOSTAT



REF		°C	REF	OEM				
REC13310			REC437090	437090	TERMOSTATO	THERMOSTAT	TERMOSTATO	THERMOSTAT
			REC332944	332944	TAPA	COVER	COPERCHIO	COUVERCLE
			REC331188	331188	TÓRICA	O-RING	O-RING	JOINT TO-RIQUE
			337067	MUELLE	SPRING	MOLLA	RESSORT	
			REC339044	339044	JUNTA	GASKET	GUARNIZIONE	JOINT



REF		°C	REF	OEM				
REC13280	V6 Crossflow	143°	REC6F5-12411-03	434841	TERMOSTATO	THERMOSTAT	TERMOSTATO	THERMOSTAT
			REC27-62386001	310058	RETÉN	SEAL	PARAOLIO	JOINT SPI
			REC321184	321184	JUNTA	GASKET	GUARNIZIONE	JOINT
			REC320880	320880	ASIENTO VÁLVULA	VALVE SEAT	SEDE VALVOLA	JOINT DE VALVE
			REC321027	321027	VÁLVULA	VALVE	VALVOLA	SOUPAPE
			REC321222	321222	TAPA VÁLVULA	VALVE CUP	COPERCHIO VALVOLA	COUVERCLE SOUPAPE
			REC317245	317245	MUELLE	SPRING	MOLLA	RESSORT
			REC321221	321221	DIAFRAGMA VÁLVULA	VALVE DIAPHRAGM	MEMBRANA DI VALVOLA	JOINT DE VALVE
			REC321220	321220	MUELLE RETENEDOR	SPRING RETAINER	MOLLA DI CONTENIMENTO	RESSORT RETENEUR



REF		°C	REF	OEM				
REC13260	V6 Offshore	133°	REC437090	437090	TERMOSTATO	THERMOSTAT	TERMOSTATO	THERMOSTAT
			REC332944	332944	TAPA	COVER	COPERCHIO	COUVERCLE
			REC331188	331188	TÓRICA	O-RING	O-RING	JOINT TORIQUE
			337067	MUELLE	SPRING	MOLLA	RESSORT	
			REC343105	3343105	CAMISA	SLEEVE	CAMICIA	BAGUE DE THERMOSTAT
			REC339044	339044	JUNTA	GASKET	GUARNIZIONE	JOINT



JUNTAS TERMOSTATO

THERMOSTATO GASKETS

REF	OEM		GOMA RUBBER GOMMA CAOUTCHOUT	CORCHO CORK SUGHERO LIEGE
REC323582	323582	2 cyl. Crossflow, 9.9 - 25 HP	✓	



REF	OEM		GOMA RUBBER GOMMA CAOUTCHOUT	CORCHO CORK SUGHERO LIEGE
REC0329319	329319	2 Cyl, Crossflow 8 - 30 HP	✓	



REF	OEM		GOMA RUBBER GOMMA CAOUTCHOUT	CORCHO CORK SUGHERO LIEGE
REC339044	339044	60° V4, V6	✓	



GUARNIZIONI TERMOSTATO

JOINTS DE THERMOSTAT

REF	OEM		GOMA RUBBER GOMMA CAOUTCHOUT	CORCHO CORK SUGHERO LIEGE
REC27-62386001	310058	2 Cyl, Crossflow 90° V6 Crossflow	✓	



REF	OEM		GOMA RUBBER GOMMA CAOUTCHOUT	CORCHO CORK SUGHERO LIEGE
REC332130	332130	3 Cyl	✓	



REF	OEM		GOMA RUBBER GOMMA CAOUTCHOUT	CORCHO CORK SUGHERO LIEGE
REC3852120	313416	3 CYL		✓



REF	OEM		GOMA RUBBER GOMMA CAOUTCHOUT	CORCHO CORK SUGHERO LIEGE
REC321932	321932	90° V4 Crossflow		✓



ASIENTO DE TERMOSTATO

THERMOSTATO SEAT

SEDE DI TERMOSTATO

JOINT DE THERMOSTAT

REF	OEM	
REC335981	335981	

CUBIERTAS TERMOSTATO

THERMOSTATO COVER

COPERCHIO TERMOSTATO

COUVERCLE DE THERMOSTAT

REF	OEM		
REC343141	343141	50 - 70 HP (1986+)	

REF	OEM		
REC332944	332944	2 Cyl, Loopcharged (1997) V6 Offshore	

REF	OEM		
REC338632	338632	60° V4, V6	

REF	OEM		
REC344771	344771 0344771	EFI & E-TECH 200 - 300 HP (1999+)	

GRUESO

GROMMET

SPESSORE

BAGUE

REF	OEM		
REC321692	321692	V4 Crossflow	

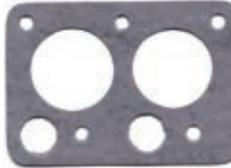
JUNTAS TAPA DE REFRIGERACIÓN			GASKET, EXHAUST INNER COVER	GUARNIZIONE COPERCHIO REFRIGERAZIONE			JOINT DE PLAQUE DE REFROIDISSEMENT
REF	OEM			REF	OEM		
REC329076	329076	6 - 8 HP		REC336947	336947	5, 6, 8, 10, 15 HP (1991-01)	
REF	OEM			REF	OEM		
REC308328	308328	2 Cyl Crossflow		REC311145	311145	2 Cyl Crossflow	
REF	OEM			REF	OEM		
REC318917	318917	2 Cyl Crossflow		REC329830	329830	2, 3 Cyl Loopcharged 90° V4 Loopcharged	
REF	OEM			REF	OEM		
REC332108	332108	3 Cyl 49 C.I. (1985-88)		REC305586	305586	90° V4 Crossflow	
REF	OEM			REF	OEM		
REC332369	332369	90° V4 Crossflow		REC321184	321184	90° V6 Crossflow	
				REF	OEM		
				REC337068	337068	90° V6 Loopcharged	
VÁLVULA ANTIPRESIÓN DE TERMOSTATO			THERMOTAT, PRESSURE VALVE	VALVOLA ANTI-PRESSIONE DE TERMOSTATO			SOUPAPE DE PRESSION DE THERMOSTAT
REF	OEM			REF	OEM		
REC318395	318395	V4 Crossflow		REC321027	321027	V6 Crossflow	
RESORTE			SPRING	MOLLA			RESSORT
REF	OEM						
REC337067	337067						
REC317245	317245						
RETENEDOR MUELLE			SPRING RETAINER	TENUTA MOLLA			COUPELLE DE RESSORT
REF	OEM						
REC321220	321220	V6 Crossflow					

DIAFRAGMA DIAPHRAGM MEMBRANA DIAPHRAGME

REF	OEM	
REC435957	321692	2 Cyl, 3 Cyl V4 Loopcharged



REF	OEM	
REC394408	394408	V4 / V6 Loopcharged



REF	OEM	
REC321221	321221	V6 Crossflow



ASIENTO DE VÁLVULA VALVE SEAT SEDE DI VALVOLA JOINT DE VALVE

REF	OEM	
REC320880	320880	V6 Crossflow



TAPA CUP COPERCHIO COUVERCLE

REF	OEM	
REC330273	330273	V4 / V6 Loopcharged



REF	OEM	
REC321222	321222	V6 Crossflow



CAMISA TERMOSTATO THERMOSTAT SLEEVE MANICOTTO TERMOSTATO LOGEMENT THERMOSTAT

REF	OEM	
REC343105	343105	



REF	OEM	
REC336178	336178	2 Cyl, 3 Cyl, V4 Loopcharged



REF	OEM	
REC337533	337533	90° V6 Loopcharged



ARANDELA WASHER RONDELLA RONDELLE

REF	OEM	
REC336185	336185	2 Cyl, 3 Cyl V4 Loopcharged



NIPLE NIPPLE NIPLE TETINE

REF	OEM		
REC126776	126776	5/16	60 - 70 HP (1988+)



REF	OEM		
REC321886	321886	3/8	9.9 - 15 HP(1978-95) 20 - 35 HP (1978-80) 3 Cyl, V4 (-1978), V6 (1978-92) 40 - 60 HP, 2 Cyl (1978-91) V6 (1987-90) Loopcharged V8 (1986-91) Con dirección hidráulica. With Power Steering. Con timoneria idraulica. Avec direction hydraulique



KIT	PLUG WATER FLUSH	KIT TAPPO	KIT BOUCHON
REF	OEM		
REC17913-93J00	5035054 J/BJ 25 - 225 HP	REC17914-93J00	5035055

GUÍA DE TERMOSTATO		THERMOSTAT GUIDE		GUIDA TERMOSTATO		GUIDE THERMOSTAT				
	KIT	TERMOSTATO THERMOSTAT TERMOSTATO THERMOSTAT	VÁLVULA VALVE VALVOLA SOUPAPE	KIT VÁLVULA VALVE KIT KIT VALVOLA KIT SOUPAPE	DIAPHRAGMA DIAPHRAGM MEMBRANA DIAPHRAGME	RETÉN VÁLVULA VALVE RETAINER TENUTA VALVOLA JOINT SOUPAPE	TAPA VÁLVULA VALVE CUP COPERCHIO VALVOLA COUVERCLE SOUPAPE	MUELLE VÁLVULA VALVE SPRING MOLLA VALVOLA RESSORT SOUPAPE	GOMA GROMMET GOMMA BAGUE	
5	1965-68, 86	REC13350	REC6F5-12411-03							
5.5	1959-64	REC13350	REC6F5-12411-03							
6	1965-79, 86	REC13350	REC6F5-12411-03							
7.5	1980-86	REC13350	REC6F5-12411-03							
8	1986	REC13350	REC6F5-12411-03							
9.5	1964-73	REC13350	REC6F5-12411-03							
9.9	1974-86	REC13350	REC6F5-12411-03							
10	1959-63	REC13350	REC6F5-12411-03							
15	1974-86	REC13350	REC6F5-12411-03							
18	1959-73	REC13350	REC6F5-12411-03							
20	1981-94	REC13350	REC6F5-12411-03							
25	1969-94	REC13350	REC6F5-12411-03							
28	1989-94	REC13350	REC6F5-12411-03							
30	1986-94	REC13350	REC6F5-12411-03							
35	1959-76, 94	REC13350	REC6F5-12411-03							
40	1960-69	REC13350	REC6F5-12411-03							
45	1989-92	REC13350	REC6F5-12411-03							
50	1971, 75, 79, 81, 86	REC13350	REC6F5-12411-03							
55	1976-92	REC13350	REC6F5-12411-03							
60	1969-70	REC13350	REC396987							
60	1980-86	REC13350	REC6F5-12411-03							
60,60 TTL	1993		REC878904							
65	1971-73	REC13450	REC396987							
65	1993		REC878904							
65C	1984-86	REC13450	REC396987							
65Jet	1994-95	REC13270	REC6F5-12411-03	REC318395				REC317245	REC321692	
70	1974-86	REC13450	REC396987							
70,70 TTL	1993		REC878904							
75	1978-88	REC13450	REC396987							
80Jet	1994-95	REC13270	REC6F5-12411-03	REC318395				REC317245	REC321692	
85	1978-80	REC13270	REC6F5-12411-03	REC318395				REC317245	REC321692	
85	1993-95		REC6F5-12411-03	REC318395				REC317245	REC321692	
88	1987-95		REC6F5-12411-03	REC318395				REC317245	REC321692	
90	1983-95		REC6F5-12411-03	REC318395				REC317245	REC321692	
90 Jet	1994		REC6F5-12411-03	REC318395				REC317245	REC321692	
100	1979-80		REC6F5-12411-03	REC318395				REC317245	REC321692	
100	1990-95		REC6F5-12411-03	REC318395				REC317245	REC321692	
100 Comm	1984-95		REC6F5-12411-03	REC318395				REC317245	REC321692	
110	1985-89		REC6F5-12411-03	REC318395				REC317245	REC321692	
112	1994-95	REC13270	REC6F5-12411-03	REC318395				REC317245	REC321692	
115	1978-95	REC13270	REC6F5-12411-03	REC318395				REC317245	REC321692	
120	1988-91				REC394408		REC330273			
140	1978-85	REC13270	REC6F5-12411-03	REC318395				REC317245	REC321692	
140	1988-91				REC394408		REC330273			
150	1978-91	REC13350	REC6F5-12411-03	REC321027	REC320880	REC321221	REC321220	REC321222	REC317245	REC321692
155	1984-91	REC13350	REC6F5-12411-03	REC321027	REC320880	REC321221	REC321220	REC321222	REC317245	REC321692
175	1977-91	REC13350	REC6F5-12411-03	REC321027	REC320880	REC321221	REC321220	REC321222	REC317245	REC321692
185	1984-85	REC13350	REC6F5-12411-03	REC321027	REC320880	REC321221	REC321220	REC321222	REC317245	REC321692
200	1977-83	REC13350	REC6F5-12411-03	REC321027	REC320880	REC321221	REC321220	REC321222	REC317245	REC321692
200	1988-93					REC394408	REC321220	REC330273		
225	1988-93					REC394408	REC321220	REC330273		
235	1978-85	REC13350	REC6F5-12411-03	REC321027	REC320880	REC321221	REC321220	REC321222	REC317245	REC321692

REF	OEM	CEF	A	B	C	CHAVETA KEY CIAVETTA CLAVETTE
REC0767407	433935		11,28	34	17,56	
REC386084	386084	CEF500355	12,75	38,6	17,6	REC300611
REC395289	395289	CEF500370C	16	51	19	REC344470
REC765431	382547	CEF500307	19,25	91,5	25,4	REC308928
REC775518	375638	CEF500351	12,7	69	12,8	REC308928
REC396725	396725	CEF500303C	19,13	91,5	25,4	REC331901 REC334897
REC777213	377230	CEF500352	16,04	69,8	22,1	REC308928
REC385072	385072	CEF500306	19,15	89	31,9	REC308928
REC777212	389642	CEF500305	22,32	89	31,9	REC308928
REC777129	389589	CEF500345	16,04	69,20	22,25	REC300611
REC5001593	435821 5001593		22,41	89	31,9	REC331107
REC777214	396809	CEF500346C	16,04	70	22,3	REC331901
REC432941	432941	CEF500372C	19,13	91,30	25,40	REC334897
REC434424	434424	CEF500350	11	69	12,8	REC300611
REC389576	389576 436137	CEF500354G	11,2	38,4	17,9	REC300611
REC763735	387361	CEF500358	11,2	38,4	17,9	
REC390286	390286	CEF500353	17,5	51,5	19	REC308928
REC17461-98503	5030188	CEF500336	10,15	41	14	REC09420-03002
REC17461-93903	5033112	CEF500329	13,2	42	22	REC17462-93990
REC17461-96312	5031417	CEF500362G	17,1	67,5	16,18	REC09420-04006
REC17461-87E12	5030723	CEF500365	22,2	78,3	35,1	
REC17461-90J01	5033542	CEF500367	24,3	86	31,7	REC09420-05009

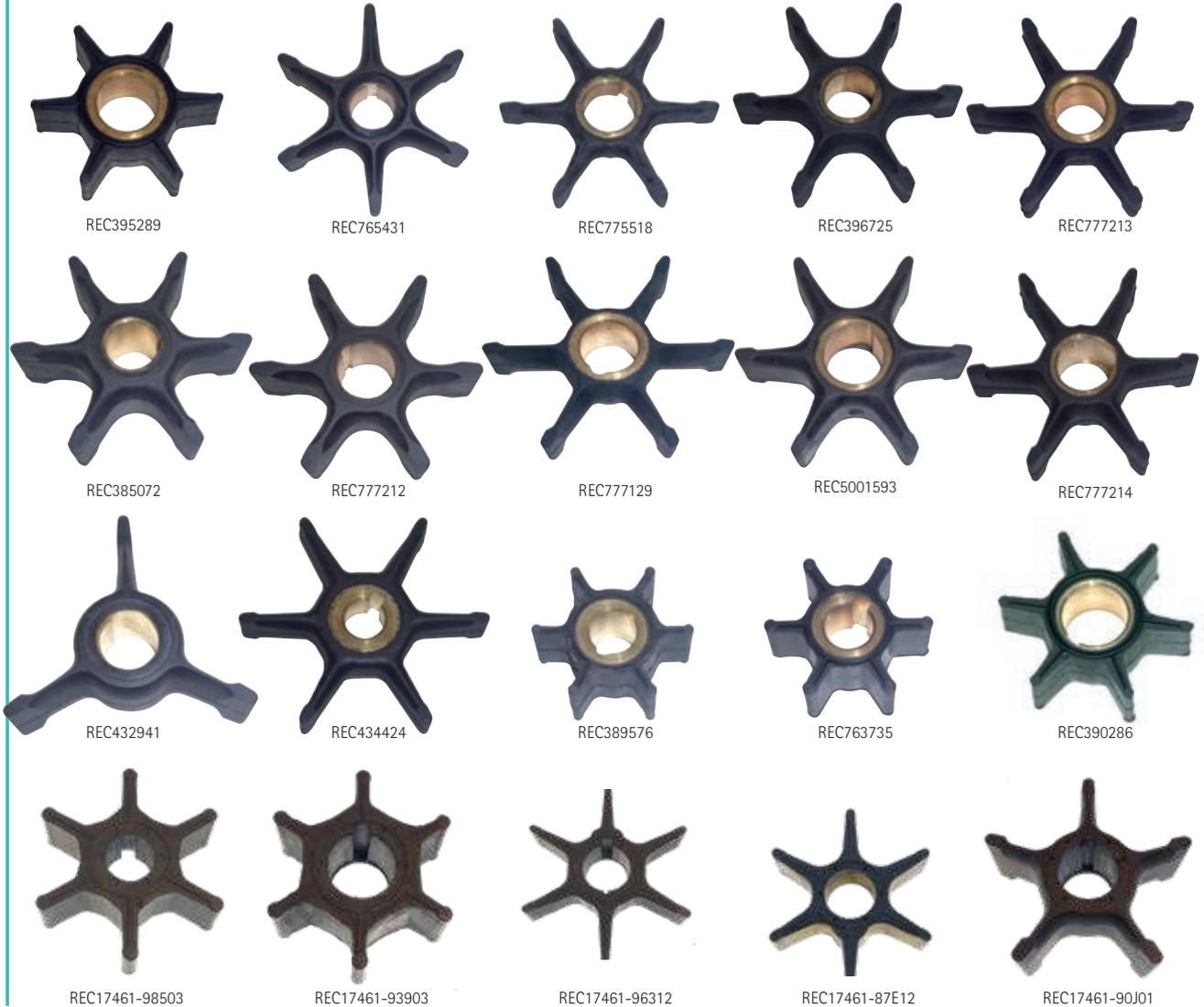
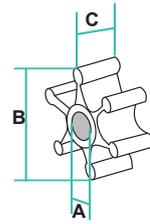

CHAVETA		KEY		CHIAVETTA		CLAVETTE	
REF	OEM	2T STROKES	4T STROKES		2T STROKES	4T STROKES	
REC331901	331901						Plástico
REC344470	330619	✓					Plastic
REC331107	331107						Plastico
							Plastique
REF	OEM	2T STROKES	4T STROKES		2T STROKES	4T STROKES	
REC334897	334897	✓					Plástico
							Plastic
							Plastico
							Plastique
REF	OEM		2T STROKES	4T STROKES	new		
REC09420-04006	5031281	25, 30, 40, 50 HP		✓			
REF	OEM		2T STROKES	4T STROKES	new		
REC17462-93990	5033113	10, 15 HP		✓			
REF	OEM		2T STROKES	4T STROKES	new		
REC09420-03002	5030137	4, 5, 6 HP		✓			
REF	OEM		2T STROKES	4T STROKES	new		
REC09420-05009	5034842 5033632 5084842	90, 115, 140 HP 200, 225 HP		✓			

KITS DE RETENES		SEAL KIT		KIT TENUTE		KITS JOINTS			
REF	OEM		2T STROKES	4T STROKES	REF	OEM		2T STROKES	4T STROKES
REC25700-95D01	5032167, 5036040	E25 / J25 / E30 / J30 (2000-07)		✓	REC25700-88L00	5031456	E40 / J40 / BJ40 E50 / J50 / BJ50 (1999-06)		✓
REF	OEM		2T STROKES	4T STROKES	REF	OEM		2T STROKES	4T STROKES
REC25700-95J00	5037038	J25 / BJ25 (2006-07)			REC25700-99E00	5034776	J60 / J70 / BJ60 / BJ70 (2005-06)		✓

new

REF	OEM	
REC25700-87E00	5030973 5034775	J/BJ 60, 70 HP

REF	OEM		2T STROKES	4T STROKES
REC25700-92J00	5033922	J140 / BJ140 (2003-06)		✓

REF	OEM		2T STROKES	4T STROKES
REC25700-90J01	5033798	J90 / BJ90 J115 / BJ115 (2003-06)		3

REF	OEM		2T STROKES	4T STROKES
REC25700-93J00	5035077	J200 / J225 / BJ200 / BJ225 (2004-06)		3

AROS TÓRICOS O-RING O-RING JOINT TORIQUE

REF	OEM	Ø INT. (")	ANCHO WIDTH LARGHEZZA LARGEUR
REC25-48171	202893	.370	.065
REC301877	301877	.245	.155
REC301967	301967	.799	.103
REC25-33145	302337	2.025	.135
REC302537	302537	1.375	.100
REC125017	302540	1.000	.135
REC302588	302588	1.735	.135
REC339543	303059 339543	.500	.100
REC3852045	303067 329381	.360	.100
REC25-62702	303191	.301	.070
REC303347	303347	.445	.090
REC25-35027	303360	1.060	.135
REC304174	304174	.500	.065
REC305123	305123	3.780	.135
REC305242	305242	.300	.135
REC3852928	305270	1.620	.135

REF	OEM	Ø INT. (")	ANCHO WIDTH LARGHEZZA LARGEUR
REC332583	305739 317178 332583 332584	.250	.065
REC308876	308876	2.235	.100
REC309731	309731	1.185	.100
REC310414	310414	3.625	.135
REC310584	310584	.750	.135
REC25-30613	310585, 310967	.740	.100
REC25-62705	311338	.750	.065
REC313175	313175	4.750	.135
REC313340	313340	1.690	.100
REC967344	313446	3.315	.135
REC313754	313754	1.835	.100
REC338518	313893 338518	2.550	.100
REC314491	314491	.970	.065
REC314728	314728	2.125	.100

REF	OEM	Ø INT. (")	ANCHO WIDTH LARGHEZZA LARGEUR
REC318372	318372	.320	.155
REC318717	318717	1.500	.210
REC0319662	319662	1.799	.103
REC326649	326649 329380 909047	.620	.100
REC326741	326741	4.484	.139
REC333572	333572	.250	.100
REC335523	335523		
REC338522	338522		
REC553126	553126	3.250	.135
REC0554545	554545	1.120	.100
REC908194	908194	4.000	.100
REC908383	908383	2.485	.100
REC909140	909140		
REC25-25439	3852565	.862	.103



RETENES

GEARCASE SEAL

TENUTE PIEDE

JOINTS

REF	OEM	EJE SHAFT ASSE ARBRE	CALIBRE BORE FORO CALIBRE	REF	OEM	EJE SHAFT ASSE ARBRE	CALIBRE BORE FORO CALIBRE	REF	OEM	EJE SHAFT ASSE ARBRE	CALIBRE BORE FORO CALIBRE
REC302564	302564	0.7500	1.3750	REC911685	911685	2.0000	2.5000	REC313353	313353	1.9375	2.4375
REC303345	303345	0.5625	1.0000	REC3853655	916058	0.5000	0.9062	REC26-419533	313992	1.1875	1.8750
REC767970	305987	1.0000	1.3750	REC321786	321786	0.6250	1.1250	REC314167	314167	0.4375	0.9375
REC309989	309989	1.3750	2.0000	REC321787	321787	0.6250	1.1250	REC318972	318972	0.5000	0.8750
REC310599	310599	1.0000	1.5000	REC321788	321788	0.5000	1.0000	REC26-76868	320862	1.1875	1.6875
REC310649	310649	2.5000	3.0000	REC331103	331103	1125	1625	REC26-69188	321453	0.8750	1.2500
REC313282	313282	0.5625	1.0625	REC341280	341280	875	1375	REC321459	321459	0.6250	1.1250
REC313284	313284	0.6250	1.1250	REC3852548	3852548	1.3750	2.1875	REC321466	321466	0.7500	1.1250
REC341281	314281	1.25	1.6875	REC321831	321831	0.7500	1.2500	REC321467	321467	1.0000	1.3750
REC330327	330327	0.6250	1.1250	REC321895	321895	1.5625	1.9219	REC321480	321480	0.5000	1.2500
REC342786	332205	0.7500	1.2500	REC321928	321928	0.6250	1.3750	REC981195	981195	1.5000	2.1250
REC332261	332261	0.6250	1.3750	REC324639	324639	0.4375	0.9375	REC981196	981196	1.7500	2.5000
REC908855	908855	625	1000	REC327031	327031	0.4375	0.8750	REC981268	981268	1.6250	2.5000
REC353076	332942	1.5625	2.0625	REC329922	329922	0.8125	1.3750	REC321481	334950	1.2500	1.6875
REC339620	339620	1.6250	2.1250	REC329923	329923	0.8750	1.3750	REC342786	342786	0.7500	1.1875
REC911019	911019	1.0000	1.3750	REC330137	330137	1.1250	1.6250				



JOHNSON EVINRUDE



GUÍA RETENES

GEARCASE SEAL
APPLICATION

GUIDA TENUTE PIEDE

GUIDE DES JOINTS

Reten	Año	EJE HÉLICE PROP SHAFT ASSE ELICA ARBRE D'HELICE		EJE COLA DRIVE SHAFT ASSE PIEDE ARBRE D'EMBASE		Reten	Año	EJE HÉLICE PROP SHAFT ASSE ELICA ARBRE D'HELICE		EJE COLA DRIVE SHAFT ASSE PIEDE ARBRE D'EMBASE	
		UN.	UN.	UN.	UN.			UN.	UN.		
1,5, 2, 2.5, 3	1958-68		1	REC327031	1	48	1988-95	REC321467	2	REC342786	1
1.5, 2	1968-90	REC327031	1	REC327031	1	50 (Manual)	1971-74	REC330137	2	REC321459	2
2.5, 4	1973-80	REC327031	1	REC327031	2	50	1975	REC321467	2	REC321466	1
2.5	1987	REC324639	2	REC327031	2	50	1979	REC330137	2	REC321459	2
2.5, 4	1981-95		1	REC327031	2	50	1980	REC321467	2	REC321466	1
3 Weedless	1958-68	REC327031	1		1	50/60 (Pull Start)	1981-83	REC330137	2	REC321459	1
3, 4, 6 Weedless	1968-82	REC314167	1	REC314167	1	50/60 (Electric)	1981-83	REC321467	2	REC321466	1
4	1981-90	REC324639	2		1	50/60	1984-85	REC321467	2	REC321466	1
4	1984, 1986-95		1	REC324639	2	50/60 corto Small	1986-87	REC321467	2	REC342786	1
4.5, 7.5	1980-87		1	REC324639	1	50/60 Corto court				REC321466	
5, 5.5, 6, 7.5	1957-64	REC303345	1	REC303345	1	50/60 largo Large	1986-87	REC330137	2	REC342786	1
5, 6, 8	1980-87		1	REC324639	2	50/60 largo longue				REC321466	
6	1965-67		1	REC313282	1	50/60	1988-89	REC330137	2	REC342786	1
6	1968-79	REC313282	1	REC314167	1	50	1990-95	REC321467	2	REC342786	1
9.5	1964-73	REC303345	1	REC303345	1	55	1968-69	REC310599	2	REC321466	2
9.9	1974-83	REC321481	1	REC321480	1	55	1976-77	REC321467	2	REC321466	2
9.9	1984-95	REC321481	1	REC321480	1	55	1978	REC321466	1	REC321466	2
10	1957-58	REC313284	1	REC321788	1	55	1979-83	REC330137	2	REC321459	1
10	1959-63	REC303345	1	REC303345	1	55 (Electric)	1980-83	REC310599	2	REC321466	2
10	1981	REC313282 (INNER)	1		1	55 C	1984	REC330137	2	REC330327	1
10	1989	REC321787	1	REC330327	1	55 C	1985	REC330137	2	REC342786	1
14	1988-90	REC321459	1	REC321459	1	55 C	1986	REC330137	2	REC321466	1
15	1974-83	REC321481	2	REC321480	1	60	1970	REC310599	1	REC321466	2
15	1984-95	REC321481	2	REC321480	1	60 (3-Cyl.)	1971	REC330137	2	REC321466	2
18	1957	REC313284	1	REC321788	1	60 (Pull Start)	1980-83	REC330137	2	REC321459	2
18	1958-73	REC313284	1	REC321788	1	60 (Electric)	1980-83	REC330137	2	REC321466	2
20	1981-82	REC321787	1	REC321786	1	60	1970	REC310599	1	REC321466	2
20	1983	REC321786	1	REC321459	1	60 SST	1989	REC321467	2	REC342786	1
20	1984	REC318972	1	REC330327	1	60 SST	1990	REC321467	2	REC342786	1
20	1985-86	REC321459	1	REC321786	1	60 (3-Cyl.)	1987-95	REC330137	2	REC342786	1
20	1987-95	REC26-69188	1	REC321928	1	65 (3-Cyl.)	1972-73	REC330137	2	REC321466	2
25	1969-76	REC313284	1	REC321788	1	65 C	1984-85	REC330137	2	REC321466	2
25	1977-78	REC313284	1	REC321788	1	65 C	1986-89	REC330137	2	REC342786	1
25	1979-82	REC321787	1	REC321786	1	70 (L)	1974-85	REC330137	2	REC321466	2
25	1983	REC321786	1	REC321459	1	70 (S)	1986-95	REC330137	2	REC342786	1
25	1984	REC321787	1	REC321786	1	75 (L)	1986-87	REC330137	2	REC321466	1
25	1985-86	REC26-69188	1	REC321928	2	75 (S)	1975-84	REC321467	2	REC321466	2
25	1987-95	REC26-69188	1	REC330327	1	85	1969-70	REC310599	2	REC321466	2
25 C	1982	REC321786	1	REC321786	1	85	1971-72	REC330137	2	REC321466	2
25 C	1983	REC321787	1	REC321459	1	85	1973-80	REC330137	2	REC26-69188	2
25 C	1984-90	REC321459	1	REC321786	1	88	1987-94	REC330137	2	REC329922	1
28	1962-64	REC302564	1	REC313284	1	90	1981-83	REC330137	2	REC329922	2
28	1987-90	REC321787	1	REC330327	1	90	1984-94	REC330137	2	REC329922	1
30	1984-86	REC26-69188	1	REC321459	1	90 Seadrive	1985-90	REC330137	2	REC329922	1
30	1987-95	REC26-69188	1	REC321928	1	100	1971-72	REC330137	2	REC321466	2
33	1965-76	REC302564	1	REC313284	1	100	1979-80	REC330137	2	REC26-69188	2
35	1957-59	REC302564	1	REC313284	1	100 C	1984-90	REC26-76868	2	REC329922	1
35	1976	REC26-69188	1	REC321459	2	110	1986-88	REC330137	2	REC329922	1
35	1977-86	REC26-69188	2	REC321928	2	115	1969-70	REC310599	2	REC321466	2
35	1987-90	REC26-69188	2	REC321928 (INNER)	1	115	1973-83	REC330137	2	REC26-69188	2
40	1960-61	REC302564	1	REC313284	1	115	1984-85	REC330137	2	REC329922	1
40	1962-73	REC302564	1	REC313284	1	115	1990-94	REC330137	2	REC329922	1
40	1974-76	REC302564	1	REC321481	1	120	1985	REC26-76868	2	REC329922	1
40 C	1981-86	REC302564	1	REC321481	2	120	1986-88	REC330137	2	REC329922	1
40	1984-85	REC321467	2	REC321466	2	120	1989	REC26-76868	2	REC329922	1
40 (AR, AE, AT)	1988	REC330137	1	REC330327	1	120	1990-94	REC330137	2	REC329922	1
40	1986-89	REC321467	2	REC321459	1	125	1971-72	REC330137	2	REC321466	2
45 C	1985	REC330137	2	REC330327	1						
45 C	1986	REC330137	2	REC321459	1						
45 C	1987	REC330137	2	REC342786	1						
45 C	1988-94	REC330137	2	REC330327	1						
45 C	1995	REC330137	2	REC321459	1						
				REC330327	1						
				REC321459	1						
				REC342786	1						
				REC321466	1						

EJE HÉLICE PROP SHAFT ASSE ELICA ARBRE D'HELICE	UN.	EJE COLA DRIVE SHAFT ASSE PIEDE ARBRE D'EMBASE	UN.
125 C	1989	REC26-76868	2
125 C (ESX)	1989	REC330137	2
135	1973-76	REC330137	2
140	1977-83	REC330137	2
140	1984	REC330137	2
140	1985	REC26-76868	2
140	1986-94	REC330137	2
140 TX	1989	REC26-76868	1
150	1978-83	REC26-76868	2
150	1984	REC26-76868	2
155 C	1984-85	REC26-76868	2
155 C	1986-90	REC26-76868	2
175	1977-85	REC26-76868	2
175	1986-90	REC26-76868	2

EJE HÉLICE PROP SHAFT ASSE ELICA ARBRE D'HELICE	UN.	EJE COLA DRIVE SHAFT ASSE PIEDE ARBRE D'EMBASE	UN.
185	1984-85	REC26-43035	2
185	1990	REC26-76868	2
200	1976-83	REC26-76868	2
200	1984-85	REC26-76868	2
200, 225	1986-90	REC26-76868	2
235	1978-83	REC26-76868	2
235	1984-85	REC26-76868	2
275	1985-88	REC26-76868	2
3.6L, 300	1985-90	REC26-76868	2

BOMBA DE AGUA

WATER PUMP

POMPA ACQUA

POMPE À EAU

CUERPO BOMBA DE AGUA HOUSING, WATER PUMP

CORPO, POMPA ACQUA

CORPS DE POMPE À EAU

REF	OEM		2T STROKES	4T STROKES
REC17411-93901	5033107	J10 / J15 (2002-06)		✓



REF	OEM		2T STROKES	4T STROKES
REC330560	330560	18, 25, 28 HP		✓

Escape a través de aleta de cavitación.
w/ Thru-Cavitation Plate Exhaust.
Scarico tramite aletta di cavitazione.
Échappement par la plaque de cavitación.



REF	OEM		2T STROKES	4T STROKES
REC17411-94421	5031990	E25 / E30 J25 / J30 (2002-07)		✓



REF	OEM		2T STROKES	4T STROKES
REC390613	390613	40 HP 2 Cyl. Crossflow		✓



REF	OEM		2T STROKES	4T STROKES
REC389577	389577	4 - 8 HP	✓	✓



REF	OEM		2T STROKES	4T STROKES
REC438544	3438544	2 Cyl. Loopcharged		✓



REF	OEM	STROKES	2T	4T
REC435390	435390	8, 9,9, 15 HP	✓	✓



REF	OEM	STROKES	2T	4T
REC384087	384087	2 Cyl. Loopcharged	✓	



REF	OEM	STROKES	2T	4T
REC393632	393632	20, 25, 35 HP	✓	

Con casquillo de bronce. Escape a través de la hélice.
W/ brass bushing. w/ Thru-Prop Exhaust.
Con ghiera in bronzo. Scarico tramite l'elica.
Avec insert en bronze. Echappement par hélice.



REF	OEM	STROKES	2T	4T
REC438543	438543	2 Cyl. Loopcharged 3 Cyl.	✓	



REF	OEM	STROKES	2T	4T
REC435990	435990	2V4, V6 Et V8	✓	

Con agujero spary
W/ spray hole
Con foro
Avec trou



REF	OEM	STROKES	2T	4T
REC5007968	435959	V4, V6 Et V8	✓	



JUNTA BASE DE BOMBA WATER PUMP, GASKET BASE

REF	OEM	STROKES	2T	4T
REC17472-97J00	5037432	JZR4	✓	



new

GUARNIZIONE BASE POMPA JOINT DE BASE DE POMPE A EAU

REF	OEM	STROKES	2T	4T
REC17472-87E10	5030725	J/BJ 90, 115, 140 HP	✓	

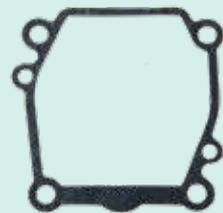

new

REF	OEM	STROKES	2T	4T
REC17472-96303	5036681 5031419	BJ J25, 30 J/BJ 40-50 HP	✓	



new

CASQUILLO **SLINGER** **BOCCOLA** **INSERT**

REF	OEM		2T STROKES	4T STROKES
REC56130-94413-OEP	5032802	J/BJ 40, 50 HP		✓



REF	OEM		2T STROKES	4T STROKES
REC325397	325397	40 HP 2 Cyl. Crossflow	✓	



REF	OEM		2T STROKES	4T STROKES
REC324641	324641	4-8 HP	✓	✓



REF	OEM		2T STROKES	4T STROKES
REC340619	340619	2 Cyl. Loopcharged 3 Cyl.	✓	



REF	OEM		2T STROKES	4T STROKES
REC324097	324097	8, 9.9, 15 HP	✓	✓



REF	OEM		2T STROKES	4T STROKES
REC320775	320775 + 320776	2 Cyl. Loopcharged	✓	



REF	OEM		2T STROKES	4T STROKES
REC328751	328751	18-35 HP 2 Cyl. Crossflow 3 Cyl.	✓	



REF	OEM		2T STROKES	4T STROKES
REC338486	338486	V4, V6 & V8	✓	



REF	OEM		2T STROKES	4T STROKES
REC17413-95J00	5036900	J/BJ 25 HP		✓



new

REF	OEM		2T STROKES	4T STROKES
REC17413-92J01	50367173	J/BJ 90, 115, 140 HP		✓



new

CIRCLIP, BOMBA DE AGUA **CLIP** **CLIP** **CLIPS**

REF	OEM	
REC09380-15001	5033027	J10, 15 HP



new

JUNTA TÓRICA BOMBA DE AGUA

WATER PUMP, O-RING

GUARNIZIONE

JOINT TORIQUE DE POMPE À EAU

REF	OEM		2T STROKES	4T STROKES	new
REC17417-92J00	5037175	J/BJ 90, 115, 140 HP		✓	

REF	OEM		2T STROKES	4T STROKES	new
REC17416-95J00	5036901	J/BJ 25		✓	

REF	OEM		2T STROKES	4T STROKES	new
REC17416-93J00	5035039	J/BJ 200, 225 HP		✓	

TAPA IMPULSOR

IMPELLER PLATE

PIASTRA GIRANTE

PLAQUE DE TURBINE

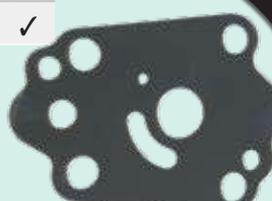
REF	OEM		2T STROKES	4T STROKES	new
REC17471-97J00	5037431	J2 HP		✓	

REF	OEM		2T STROKES	4T STROKES	new
REC17471-94401	5031418	E25, E30, E40 J25, J30, J40, J50 BJ40, BJ50 (1999-07)		✓	

REF	OEM		2T STROKES	4T STROKES	new
REC17471-98601	5031196 5030189 5031196	J5 HP		✓	

REF	OEM		2T STROKES	4T STROKES	new
REC17471-92J00	5034651 5037170 5030724 5037170	J/BJ 140, 90, 115		✓	

REF	OEM		2T STROKES	4T STROKES	new
REC17471-93902	5033114	J10 / J15 (2002-07)		✓	

REF	OEM		2T STROKES	4T STROKES	new
REC17471-92J02	5035041	J/BJ 225, 200 HP		✓	

REF	OEM		2T STROKES	4T STROKES	new
REC17471-95J01	5036902	J/BJ 25 HP		✓	

JUNTAS BOMBA

WATER PUMP GASKETS

GUARNIZIONI POMPA

JOINTS DE POMPE

REF	OEM	STROKES	2T	4T
REC17472-98611	5030190	E5 / J5 (1998)	✓	



REF	OEM	STROKES	2T	4T
REC17472-91J00	5033381	J14 / J5 / J6 (2003-07)		✓



REF	OEM	STROKES	2T	4T
REC17472-93911	5035603	J10 / J15 (2004-07)		✓



REF	OEM	STROKES	2T	4T
REC55122-94400	5031535	J40 / E40 / BJ40 J50 / E50 / BJ50 (1999-06)		✓



REF	OEM	STROKES	2T	4T
REC17452-93910	5033110	J10 / J15 (2002-07)		✓



REF	OEM	STROKES	2T	4T
REC17472-93J00	5035042	J200 / J225 BJ200 / BJ225 (2004-06)		✓

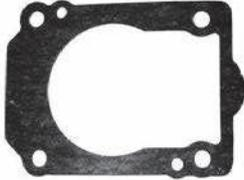

KITS DE REPARACIÓN BOMBA DE AGUA

WATER PUMP SERVICE KITS

KIT RICAMBI POMPA ACQUA

KIT REPARATION DE POMPE À EAU

REF	OEM	STROKES	2T	4T
REC12065		4, 4.5, 5, 6, 7.5 Et 8 HP (1980+)	✓	✓



REF	OEM	STROKES	2T	4T
REC17400-98652	5030352	E4 / E5 J4 / J5 (1998-04)	✓	✓



REF	OEM	STROKES	2T	4T
REC17400-98661	5034323	J4 / J5 / J6 (2005-07)		✓



REF	OEM	STROKES	2T	4T
REC394711	394711	9.9, 15 HP (1974+) (1994+)	✓	✓



REF	OEM		2T STROKES	4T STROKES
REC17400-93951	5033106	J10 / J15 (2002-06)		✓

REF	OEM		2T STROKES	4T STROKES
REC17400-94J00	5037545	J10, 15 HP		✓

new

REF	OEM		2T STROKES	4T STROKES
REC395270	395270	18, 25 Et 28 HP 2-Cyl. (1979-98)		✓

Crossflow con escape a través de la hélice y cola de una pieza
 Crossflow with thru-prop exhaust and one-piece gearcase.
 Crossflow con scarico dall'elica e piede in 1 pezzo.
 Crossflow avec échappement par l'hélice. carter 1 partie

REF	OEM		2T STROKES	4T STROKES
REC393630	393630	20-35 HP 2 Cyl. (1980-05)		✓

Crossflow con escape a través de la hélice y cola de una pieza
 Crossflow with thru-prop exhaust and one-piece gearcase.
 Crossflow con scarico dall'elica e piede in 1 pezzo.
 Crossflow avec échappement par l'hélice. carter 1 partie

REF	OEM		2T STROKES	4T STROKES
REC17400-95J02	5036908	J/BJ 25 HP		✓

new

REF	OEM		2T STROKES	4T STROKES
REC437907	437909	25, 30 Et 35 HP 3-Cyl. (1996-01) Loopcharged		✓

REF	OEM		2T STROKES	4T STROKES
REC391741	391741	40 HP 2 Cyl. (1974-76) Crossflow 40 Comm. 2 Cyl. (1981-87)		✓

Crossflow con escape a través de la aleta de cavitación. Cola de dos piezas.
 Crossflow thru-cavitation plate exhaust and two-piece gearcase.
 Crossflow scarico attraverso l'aletta di cavitazione.
 Crossflow avec échappement par la plaque de cavitation. Carter en 2 parties

REF	OEM		2T STROKES	4T STROKES
REC438602	438602	Cola larga / large gearcase / Piede lungo 40-60 HP 2-Cyl. (1979-05) Loopcharged 65, 70 Et 75 HP 3-Cyl. (1979-85) Loopcharged		✓

Bomba agua con chaveta impulsor de plástico.
 Large water pump with the plastic wedge key impeller.
 Piede a gambo lungo. Pompa acqua con chiave girante in plastica.
 Pompe à eau avec clavette de turbine en plastique

REF	OEM		2T STROKES	4T STROKES
REC5000308	5000308	40, 45 Et 55 HP (1995-05) 40, 50 Et 60 HP 2-Cyl.		✓

Loopcharged cola larga. Bomba de agua grande con impulsor de seis palas.
 Loopcharged large gearcase. Large water pump with the six vane impeller.
 Loopcharged piede con gambo lungo. Pompa acqua grande con girante a sei pale.
 Loopcharged embase large. Grande pompe à eau avec turbine 6 pales

REF	OEM		2T STROKES	4T STROKES
REC438592	438592	40, 45, 48 Et 50 HP 2-Cyl. (1989-05)	✓	

Loopcharged cola corta. Bomba de agua grande con impulsor tres palas.
 Loopcharged small gearcase. Large water pump with the three vane impeller.
 Loopcharged piede con gambo corto. Pompa acqua grande con girante a tre pale.
 Loopcharged embase courte. Pome à eau avec turbine 3 pales



REF	OEM		2T STROKES	4T STROKES
REC17400-87E04	5031731	E70 (1999-00)		✓

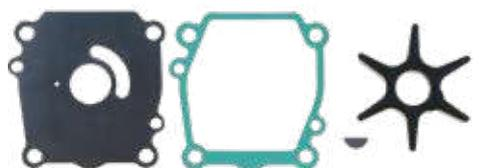

REF	OEM		2T STROKES	4T STROKES
REC17400-92J00	5037176	J/BJ 90, 115, 140 HP		✓

new



REF	OEM		2T STROKES	4T STROKES
REC17400-96403	5031744	E40 / J40 E50 / J50 (2000-02)		✓

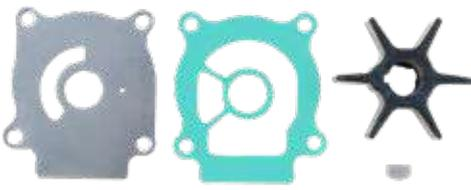

REF	OEM		2T STROKES	4T STROKES
REC17400-90J20	5033541	J90 / J115 / J140 BJ90 / BJ118 / BJ140 (2003-06)		✓

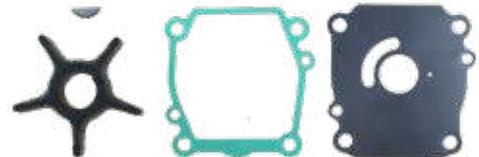

REF	OEM		2T STROKES	4T STROKES
REC432955	432955	65, 70 Et 75 HP 3 Cyl. (1986-01)	✓	

Loopcharged con cola larga. Bomba de agua grande con chaveta de impulsor de plástico.
 Loopcharged large gearcase. Large water pump with plastic wedge key impeller.
 Loopcharged piede a gambo lungo. Pompa acqua grande conchiave girante in plastica.
 Loopcharged embase longue. Pompe à eau avec clavette en plastique



REF	OEM		2T STROKES	4T STROKES
REC17400-93J01	5035036	J200 / J225 BJ200 / BJ225 (2004-06)		✓



REF	OEM		2T STROKES	4T STROKES
REC438579	438579	70 Et 75 HP 3-Cyl. (1974-78) Loopcharged	✓	

Cola larga. Bomba de agua grande con chaveta impulsor de media luna.
 Large gearcase. Large water pump with half-moon key impeller.
 Piede a gambo lungo. Pompa acqua grande, con calettatura girante a mezza luna.
 Embase longue. Pompe à eau avec clavette demi lune



REF	OEM		2T STROKES	4T STROKES
REC389133	389133	2 Cyl. (1971-78) 3 Cyl. Loopcharged	✓	

Loopcharged cola corta. Bomba de agua pequeña
 Loopcharged small gearcase. Small water pump
 Loopcharged piede con gambo corto. Pompa acqua piccola.
 Loopcharged embase courte. Petite pompe à eau.



REF	OEM		2T STROKES	4T STROKES
REC439077	439077	2 Cyl. (1984-94) 3 Cyl. Loopcharged		✓

Loopcharged cola corta. Bomba de agua pequeña casquillo impulsor de plástico
 Loopcharged small gearcase. Small water pump with plastic wedge key impeller.
 Loopcharged piede con gambo lungo. Pompa acqua grande con girante a sei pale.
 Loopcharged embase courte. Grande pompe à eau avec turbine 6 pales.



REF	OEM		2T STROKES	4T STROKES
REC5001594	5001594	V4/V6/V8		✓

V4/V6/V8 con eje 20" (1979-06) Chaveta impulsor de plástico
 V4/V6/V8 with 20" shaft (1979-06) Plastic wedge key impeller.
 V4/V6/V8 con asse da 20" (1979-06) Chiave girante in plastica.
 V4/V6/V8 avec arbre de 20" (1979-06) Clavette turbine en plastique.



REF	OEM		2T STROKES	4T STROKES
REC395073	0395073	(1977-78) V4 (1976-78) V6		✓

V4 con cambio mecánico/hidráulico.
 V6 con cambio mecánico/hidráulico. Chaveta impulsor de media luna.
 V4 with mech./hydraulic shift.
 V6 with mech./hydraulic shift. Half-moon key impeller.
 V4 con cambio meccanico/idraulico.
 V6 con cambio meccanico/idraulico. Calattatura girante a mezza luna
 V4 avec changement mecanique/hydraulique.
 V6 avec changement mecanique/hydraulique. Clavette de turbine demie lune.



REF	OEM		2T STROKES	4T STROKES
REC5001595	5001595	V4/V6/V8 (1979-06)		✓

Con ejes de 25 y 30". Es el mismo kit que el REC5001594 pero con un agujero en el cuerpo de la bomba para refrigeración extra. Chaveta impulsor de plástico.
 With 25" and 30" shaft. Same water pump kit as REC5001594 except with a spray hole in pump housing for extra cooling of the long shaft exhaust housings. Plastic wedge key impeller.
 Con asse da 25 e 30" Il kit è identico al REC5001594, l'unica differenza è un foro nel corpo pompa che permette una refrigerazione extra.
 Avec arbre de 25" et 30". C'est le même kit que REC5001594 mais avec un trou dans le cors de la pompe pour une refroidissement extra. Clavette turbine en plastique.



REF		2T STROKES	4T STROKES	REF	OEM					
REC12104		✓		REC5001593	435821	IMPULSOR	IMPELLER	GIRANTE	TURBINE	X 1
				REC331107	331107	CHAVETA	KEY	CHIAVE	CLAVETTE	X 1
				REC338486	338486	TAPA BOMBA	PUMP CUP	COPERCHIO POMPA	COUVERCLE POMPE	X 1
				REC338485	338485	TAPA	WATER PLATE	COPERCHIO	PLAQUE	X 1
				REC338484	338484	JUNTA	GASKET	GUARNIZIONE	JOINT	X 1
				REC25-30613	310585	TÓRICA	O-RING	O-RING	JOINT TORIQUE	X 1
				REC331353	331353	RETÉN	SEAL	TENUTA	JOINT SPI	X 1
				REC320943	320943	GRUESO	GROMMET	SPESSORE	CALE	X 1
				REC314008	314008	GRUESO TUBO	TUBE GROMMET	SPESSORE TUBO	CALE DE TUYAU	X 1
				REC338893	338893	TAPA	COVER	COPERCHIO	COUVERCLE	X 1
				REC306643	306643	TORNILLO	SCREW	VITE	VIS	X 2
				REC302325	302325	TORNILLO	SCREW	VITE	VIS	X 4
				REC332583	332584	TÓRICA	O-RING	O-RING	JOINT TORIQUE	X 1
				REC321008	321008	GRUESO CAMBIO	SHIFT GROMMET	SPESSORE CAMBIO	CALE	X 1



**GUÍA
BOMBAS DE AGUA**

WATER PUMP GUIDE

**GUIDA
POMPA ACQUA**

**GUIDE
POMPE À EAU**

	2T STROKES	4T STROKES	CUERPO HOUSING CORPO CORPS	EJE SHAFT ASSE ARBRE					KIT	KIT COMPLETO FULL KIT KIT COMPLETO KIT COMPLET	
1.5 HP - 15 HP											
1.5					1968-70	REC763735					
2					1971-88	REC763735					
2.5						REC0767407					
3					1952-68	REC434424				REC12108	
3						REC0767407					
3,4					1991-96			REC324641			
4					1969-72	REC434424				REC12108	
4 (90)					1973-80	REC763735					
4 (110)					1973-82	REC434424				REC12108	
4 (90)					1981-90	REC389576		REC324641			
4 Deluxe					1985-88	REC389576	REC324640	REC324641	REC389577	REC396644	REC12065
4 Deluxe					1989-96	REC0767407	REC324640	REC324641			
4.5					1980-84	REC389576	REC324640	REC324641	REC389577	REC396644	REC12065
5					1965-68	REC434424				REC12108	
5					1986-90	REC389576	REC324640	REC324641	REC389577	REC396644	REC12065
5		✓			-1998	REC389576	REC324640	REC324641	REC389577	REC396644	REC12065
5.5					1956-64	REC434424					
6					1965-79	REC434424					
6					1984-96	REC389576	REC324640	REC324641	REC389577	REC396644	REC12065
6		✓			-1998	REC389576	REC324640	REC324641	REC389577	REC396644	REC12065
7.5					1954-58	REC389576				REC12108	
7.5					1980-83	REC389576	REC324640	REC324641	REC389577	REC396644	REC12065
8					1984-96	REC389576	REC324640	REC324641	REC389577	REC396644	REC12065
8		✓			-1995	REC386084	REC318995	REC324097	REC435390	REC394711	
9.9	✓				1974-96	REC386084	REC318995	REC324097	REC435390	REC394711	
9.9		✓			1995-01	REC386084	REC318995	REC324097	REC435390	REC394711	
10					1956-63	REC775518					
15					1953-56	REC775518					
15	✓				1974-96	REC386084	REC318995	REC324097	REC435390	REC394711	
15		✓			1995-01	REC386084	REC318995	REC324097	REC435390	REC394711	
18 - 40 HP 2 Cyl. Crossflow											
18					1957-73	REC775518					
18					1997-98	REC395289	REC765642	REC328751	REC330560	REC395270	
20					1966-67	REC775518					
20											
a través de hélice Thru-Prop attraverso elica per Hélice					1985-98	REC395289	REC328755	REC328751	REC393632	REC393630	
25					1969-78	REC775518					
25					1969-78	REC775518					
25					1979-05	REC395289	REC765642	REC328751	REC330560	REC395270	
25											
a través de hélice Thru-Prop attraverso elica per Hélice					1985-05	REC395289	REC765642	REC328751	REC393632	REC393630	
28					1986-98	REC395289	REC765642	REC328751	REC330560	REC395270	
35											
con term w. Therm Con Term avec thermostat					1958-59	REC777213					
35											
a través de hélice Thru-Prop attraverso elica per Hélice					1980-96	REC395289	REC328755	REC328751	REC393632	REC393630	
40					1960-70	REC777213					
40					1974-76	CEF500353		REC325397	REC390613	REC391741	
40					1981-87	CEF500353		REC325397	REC390613	REC391741	
40 - 60 HP 2 Cyl. Loopcharged											
40			S		1984-88	REC777214	REC320981	REC320775	REC384087	REC439077	
40			S		1989-98	REC432941	REC341038	REC340619	REC438544	REC438592	
40 Comm.			S		1993-94	REC777214	REC320981	REC340619	REC438544	REC439077	
40			L		1995-05	REC396725	REC341038	REC340619		REC5000308	
45 Comm.			S		1986-94	REC777214	REC320981	REC320775	REC384087	REC439077	
45 Comm.			L		1995-05	REC396725	REC341038	REC340619		REC5000308	
48			S		1987-88	REC777214	REC320981	REC320775	REC384087	REC439077	
48			S		1989-98	REC432941	REC341038	REC340619	REC438544	REC438592	
50			S		1971-78	REC777213	REC320981	REC320775	REC384087	REC389133	
50			S		1979-85	REC777129	REC320981	REC320775	REC384087		
50			S		1986-88	REC777214	REC320981	REC320775	REC384087	REC439077	
50			S		1989-98	REC432941	REC341038	REC340619	REC438544	REC438592	
55 Comm.			S		1986-94	REC777214	REC320981	REC320775	REC384087	REC439077	
55			L		1995-05	REC396725	REC341038	REC340619		REC5000308	
60			S		1980-85	REC777129	REC320981	REC320775	REC384087		
60			L		1986-88	REC396725	REC341038	REC340619	REC438543	REC438602	

	2T STROKES	4T STROKES	CUERPO HOUSING CORPO CORPS	EJE SHAFT ASSE ARBRE					KIT	KIT COMPLETO FULL KIT KIT COMPLETO KIT COMPLET
3 Cyl.										
25, 35										REC437907
55										
60										
60										
60		✓			REC341038	REC340619	REC438543			REC432955
60		✓			REC341038	REC340619	REC438543			REC432955
65										
65					REC341038	REC340619	REC438543			REC432955
70					REC341038	REC340619	REC438543			REC438579
70					REC341038	REC340619	REC438543			REC432955
70		✓			REC341038	REC340619	REC438543			REC432955
75					REC341038	REC340619	REC438543			REC438579
75					REC341038	REC340619	REC438543			REC432955
V4										
85										
85										
85				25"	REC777212	REC338485	REC338486	REC435990		REC395073
85					REC777212	REC338485	REC338486	REC435990		REC395073
85					REC5001593	REC338485	REC338486	REC435990	REC12104	REC5001594
90					REC5001593	REC338485	REC338486	REC435990	REC12104	REC5001594
90				20"	REC5001593	REC338485	REC338486	REC435990	REC12104	REC5001594
90				25"	REC5001593	REC338485	REC338486	REC5007968	REC12104	REC5001595
100					REC385072					
100					REC5001593	REC338485	REC338486	REC435990		REC395073
100					REC5001593	REC338485	REC338486	REC435990	REC12104	REC5001594
100				20"	REC5001593	REC338485	REC338486	REC435990	REC12104	REC5001594
100				25"	REC5001593	REC338485	REC338486	REC5007968	REC12104	REC5001595
105					REC5001593	REC338485	REC338486	REC5007968	REC12104	REC5001595
115					REC777212					
115				25"	REC777212	REC338485	REC338486	REC435990		REC395073
115					REC777212	REC338485	REC338486	REC435990		REC395073
115					REC5001593	REC338485	REC338486	REC435990	REC12104	REC5001594
115				20"	REC5001593	REC338485	REC338486	REC435990	REC12104	REC5001594
115				25"	REC5001593	REC338485	REC338486	REC5007968	REC12104	REC5001595
120					REC5001593	REC338485	REC338486	REC435990	REC12104	REC5001594
120				25"	REC5001593	REC338485	REC338486	REC5007968	REC12104	REC5001595
125					REC385072					
130				20"	REC5001593	REC338485	REC338486	REC435990	REC12104	REC5001594
130				25"	REC5001593	REC338485	REC338486	REC5007968	REC12104	REC5001595
135					REC777212					
135				20"	REC5001593	REC338485	REC338486	REC435990	REC12104	REC5001594
135				25"	REC5001593	REC338485	REC338486	REC5007968	REC12104	REC5001595
140					REC777212	REC338485	REC338486	REC435990		REC395073
140					REC5001593	REC338485	REC338486	REC435990	REC12104	REC5001594
140				20"	REC5001593	REC338485	REC338486	REC435990	REC12104	REC5001594
140				25"	REC5001593	REC338485	REC338486	REC5007968	REC12104	REC5001595
V6										
150					REC777212	REC338485	REC338486	REC435990		REC395073
150					REC5001593	REC338485	REC338486	REC435990	REC12104	REC5001594
150				20"	REC5001593	REC338485	REC338486	REC435990	REC12104	REC5001594
150				25"	REC5001593	REC338485	REC338486	REC5007968	REC12104	REC5001595
175					REC777212	REC338485	REC338486	REC435990		REC395073
175					REC5001593	REC338485	REC338486	REC435990	REC12104	REC5001594
175				20"	REC5001593	REC338485	REC338486	REC435990	REC12104	REC5001594
175				25"	REC5001593	REC338485	REC338486	REC5007968	REC12104	REC5001595
185					REC5001593	REC338485	REC338486	REC435990	REC12104	REC5001594
185				20"	REC5001593	REC338485	REC338486	REC435990	REC12104	REC5001594
185				25"	REC5001593	REC338485	REC338486	REC5007968	REC12104	REC5001595
200					REC777212	REC338485	REC338486	REC435990		REC395073
200					REC5001593	REC338485	REC338486	REC435990	REC12104	REC5001594
200				20"	REC5001593	REC338485	REC338486	REC435990	REC12104	REC5001594
200				25" 30"	REC5001593	REC338485	REC338486	REC5007968	REC12104	REC5001595
225					REC5001593	REC338485	REC338486	REC435990	REC12104	REC5001594
225				20"	REC5001593	REC338485	REC338486	REC435990	REC12104	REC5001594
225				25" 30"	REC5001593	REC338485	REC338486	REC5007968	REC12104	REC5001595
235					REC777212	REC338485	REC338486	REC435990		REC395073
235					REC5001593	REC338485	REC338486	REC435990	REC12104	REC5001594
250				20"	REC5001593	REC338485	REC338486	REC435990	REC12104	REC5001594
250				25" 30"	REC5001593	REC338485	REC338486	REC5007968	REC12104	REC5001595
V8										
250					REC5001593	REC338485	REC338486	REC435990	REC12104	REC5001594
250				20"	REC5001593	REC338485	REC338486	REC435990	REC12104	REC5001594
250				25" 30"	REC5001593	REC338485	REC338486	REC5007968	REC12104	REC5001595
275					REC5001593	REC338485	REC338486	REC435990	REC12104	REC5001594
300					REC5001593	REC338485	REC338486	REC435990	REC12104	REC5001594
300				20"	REC5001593	REC338485	REC338486	REC435990	REC12104	REC5001594
300				25" 30"	REC5001593	REC338485	REC338486	REC5007968	REC12104	REC5001595

TUBOS DE AGUA DE CULATA

HOSE WATER CYLINDER HEAD

KIT TUBI ACQUA TESTATA

TUYAU D'EAU DE CULASSE

REF	OEM		ESTRIBOR STARBOARD TRIBORDO DROITE	BABOR PORT BABORDO GAUCHE
REC0340975	340975		90 (1994-95)	
			100 (1996-97)	
			115 (1994-97)	✓
			E88 (1996)	
			E90 (1996-98)	
REC0340976	340976		E100 (1996-97)	
			E112 (1996)	
			E115 (1996-98)	
			J88 (1996)	
			J90 (1996-98)	
			J100 (1997-98)	
			J112 (1996)	✓
			J115 (1996-98)	



CANADA METAL



ÁNODO

ANODE

ANODI

ANODE

ZN		AL		OEM
CM123009	0,09	CM123009A	0,03	123009 173029



ZN		AL		OEM
CM392462	0,65	CM392462A	0,25	392462



ZN		AL		OEM
CM327606	0,08	CM327606A	0,03	327606



ZN		AL		OEM
CM393023	0,22	CM393023A	0,09	393023



ZN		AL		OEM
CM334451	0,09	CM334451A	0,03	334451 432397



ZN		AL		OEM
CM433458	0,33	CM398331A	0,33	433458 398331

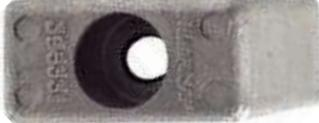

ZN		AL		OEM
CM976669	0,43	CM976669A	0,17	976669



ZN		AL		OEM
CM398873	0,15	CM398873A	0,06	398873



ZN		AL		OEM
CM389999	0,23	CM389999A	0,09	389999



ZN		AL		OEM
CM431708	0,27	CM431708A	0,10	431708



ZN		OEM	
CM338635	0,06	338635	9,9 HP 15 CV



ZN	KG (kg)	AL	KG (kg)	OEM
CM392123	0,76	CM392123A	0,29	392123



ZN	KG (kg)	OEM
CM5031705	0,02	5031705



ZN	KG (kg)	AL	KG (kg)	OEM
CM397768	0,31	CM397768A	0,12	397768



ZN	KG (kg)	AL	KG (kg)	OEM
CM5007089	0,72	CM5007089A	0,28	433580



ZN	KG (kg)	AL	KG (kg)	OEM
CM980756	0,96	CM980756A	0,37	980756



ZN	KG (kg)	OEM	HP
CM55321-93900	0,06	5033185	9,9 - 15 HP



ZN	KG (kg)	OEM
CM55321-87J00	0,02	5031705



ZN	KG (kg)	OEM	HP
CM5033167	0,05	5033167	9,9 - 15 HP



ZN	KG (kg)	AL	KG (kg)	OEM
CM984547	1,10	CM984547A	0,43	983952



ZN	KG (kg)	OEM	HP
CM5032930	0,09	5032930	90 - 115 HP



ZN	KG (kg)	OEM	HP
CM55320-98600	0,10	5030267	5 HP



ZN	KG (kg)	OEM	HP
CM5031538	0,08	5031538	2 - 8 HP



ZN	KG (kg)	OEM	HP
CM434029	0,19	434029	20 - 25 HP



ZN	KG (kg)	OEM	2T STROKES	4T STROKES
CM55125-95500	0,16	5031536	70 HP	✓



ZN	KG (kg)	OEM	60, 70, 90, 115, 140 HP (2002-06)
CM5032929	0,25	5032929	



OMC

ZN	KG (kg)	AL	KG (kg)	OEM
CM983494	0,82	CM983494A	0,32	983494



ZN	KG (kg)	OEM
CM338742	0,40	338742



ZN	KG (kg)	AL	KG (kg)	OEM
CM984513	0,97	CM984513A	0,38	984513



ZN	KG (kg)	OEM	100 -245 HP
CM982438	0,85	982277 982438	



ZN	KG (kg)	AL	KG (kg)	OEM
CM984547	0,91	CM984547A	0,35	984547



KITS

AL	KG (kg)	
CMOMCV4V6KITA	0,55	OMC V4-V6
CMOMC5075KITA	0,52	OMC 50-75 HP



ÁNODO

ANODE

ANODI

ANODE

JOHNSON EVINRUDE

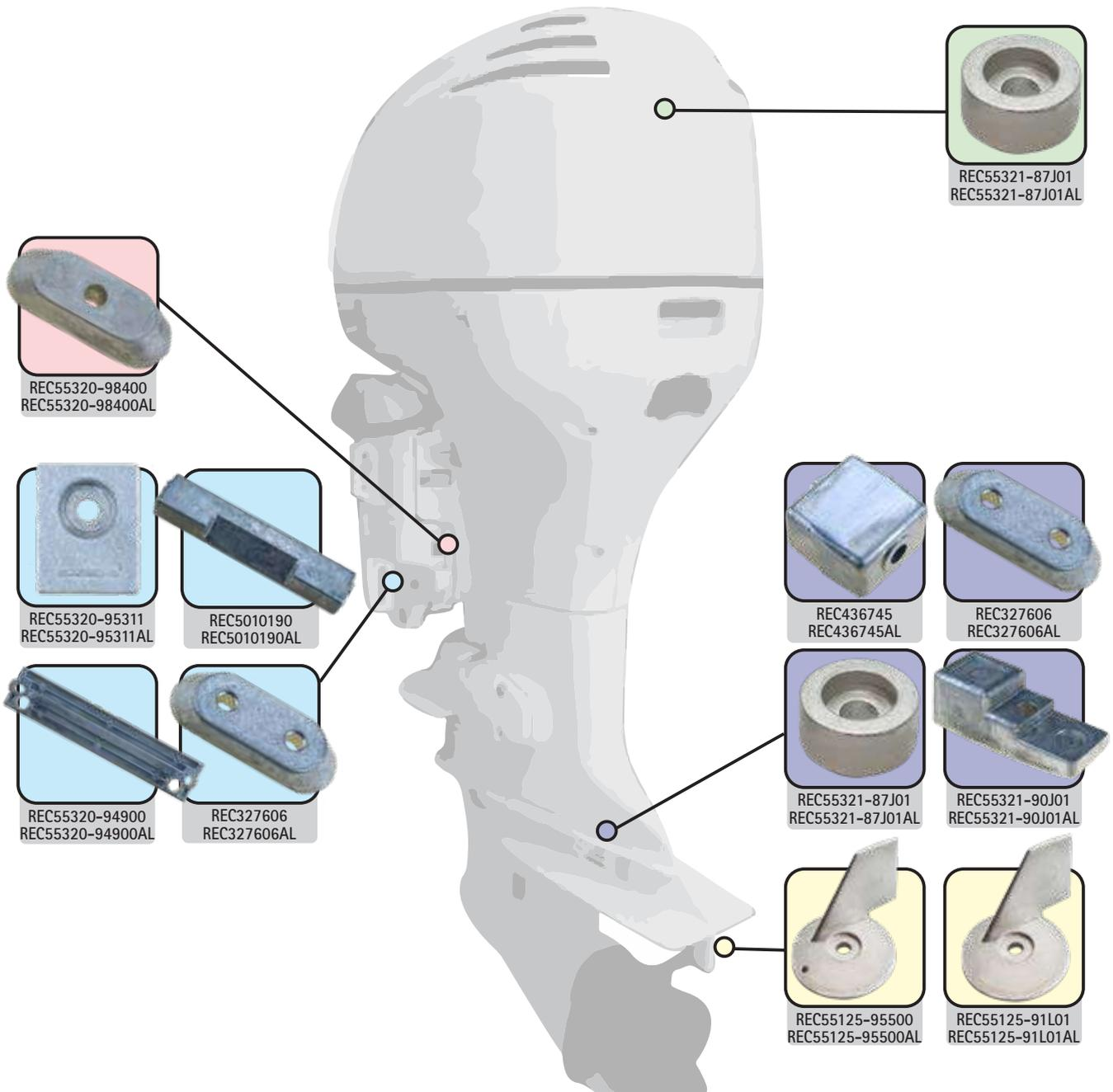

	MOTOR ENGINE MOTORE MOTEUR	SOPORTE BRACKET SUPPORTO SUPPORT	TRIM	COLA GEAR CASE PIEDE EMBASE	TRIM TAB
40HP +				REC436745 REC436745AL	
60 To 300HP (V4 & V6)		REC5010190 REC5010190AL			
1.2 TO 175HP		REC327606 REC327606AL		REC327606 REC327606AL	
40/50/70HP					REC55125-95500 REC55125-95500AL
5HP			REC55320-98400 REC55320-98400AL		
5 TO 225HP		REC55320-95311 REC55320-95311AL			
4/5/6HP				REC55321-87J01 REC55321-87J01AL	
40 TO 250HP	REC55321-87J01 REC55321-87J01AL				
60 TO 225HP		REC55320-94900 REC55320-94900AL			
25/30HP					REC55125-91L01 REC55125-91L01AL
60/70/90/115HP				REC55321-90J01 REC55321-90J01AL	

ÁNODO

ANODE

ANODI

ANODE

ZN	KG (kg)	OEM	OMC
TEN00920	0,72	987067	OMC 5700



ZN	KG (kg)	OEM	OMC
TEN00929	0,19	389999	OMC Sail Drive



ZN	KG (kg)	OEM	OMC
TEN00900	0,47	976669	OMC P



ZN	KG (kg)	OEM	OMC
TEN00906	0,73	983494	OMC



ZN	KG (kg)	OEM	OMC
TEN00901	0,58	982277	OMC M 100 - 245 HP



ZN	KG (kg)	OEM	OMC
TEN00919	0,61	986158 3853930	OMC Cobra



ZN	KG (kg)	OEM	OMC
TEN00902	0,97	385818 982438	OMC G 100 - 245 HP



ZN	KG (kg)	OEM	OMC
TEN00920	0,98	3854061 987067	OMC Cobra 5700



ZN	KG (kg)	OEM	OMC
TEN00903	0,98	3853818 984513	OMC COBRA



ZN	KG (kg)	OEM	OMC
TEN00922	1,00	3854130	OMC King Cobra



ZN	KG (kg)	OEM	OMC
TEN00904	1,29	983952	OMC COBRA 130 - 185 HP



ZN	KG (kg)	OEM	OMC
TEN00916	0,80	984547	OMC



ZN	KG (kg)	OEM	OMC
TEN00930	0,08	5030265 5035786	40 - 40/50 HP (4T/STROKES)



ZN	KG (kg)	OEM	
TEN00917	0,30	431708	OMC JOHNSON / EVINRUDE Diabolo 70 - 120 HP



ZN	KG (kg)	OEM	
TEN00907BIS	397768	3/8 UNC THREAD	



ZN	KG (kg)	OEM	
TEN00923	0,54	OMC JOHNSON / EVINRUDE 225 HP	



ZN	KG (kg)	AL	KG (kg)	OEM	
TEN00911	0,19	TEN00911AL	395780	OMC Cobra JOHNSON / EVINRUDE	



ZN	KG (kg)	OEM	
TEN00908	0,82	392123	OMC 90 - 140 HP JOHNSON / EVINRUDE 90 - 140 HP



ZN	KG (kg)	AL	KG (kg)	OEM	
TEN00928	0,25	TEN00928AL	0,100	397768	OMC JOHNSON / EVINRUDE



ZN	KG (kg)	AL	KG (kg)	OEM	
TEN00925	0,02	TEN00925AL	5031705		



ZN	KG (kg)	AL	KG (kg)	OEM	
TEN00918	0,72	TEN00918AL	5007089 433580	JOHNSON / EVINRUDE 60 - 300 HP	



ZN	KG (kg)	AL	KG (kg)	OEM	
TEN00907	0,25	TEN00907AL	393023 436745	OMC 50, 60, 70, 90, 140 HP JOHNSON / EVINRUDE 50, 115, 120, 140, 200 HP	



ZN	KG (kg)	OEM	
TEN00913	0,08	432397 334451	JOHNSON / EVINRUDE 4 - 7,5 HP



ZN	KG (kg)	OEM	
TEN00921	0,83	338635	JOHNSON 8, 9.9, 15 HP



ZN	KG (kg)	OEM		
TEN00914	0,119	434029	JOHNSON / EVINRUDE	
TEN00914/1	0,20		20 - 25 HP	✓



ZN	KG (kg)	OEM		
TEN00932	0,10	5030267	JOHNSON / EVINRUDE	
			HPS	



ZN	KG (kg)	OEM		
TEN00910	0,33	398331 433458	J/E	
			160 - 280 HP, V4, V6	



ZN	KG (kg)	AL	KG (kg)	OEM		
TEN00937	0,10	TEN00937AL		5032930	J/E	
					140 HP	



ZN	KG (kg)	OEM		
TEN00909	0,70	392462	OMC 50 - 75 HP	
			J/E 50 - 75 HP	



ZN	KG (kg)	OEM		2T STROKES	4T STROKES
TEN00934	0,05	5033185	J/E		✓
			9,9 - 15 HP		



ZN	KG (kg)	OEM		2T STROKES	4T STROKES
TEN00933	0,02	5031705	J / E 3.5, 5, 6 HP		✓



ZN	KG (kg)	OEM		2T STROKES	4T STROKES
TEN00931	0,19	5031536	J/E 70 HP		✓



ZN	KG (kg)	OEM		2T STROKES	4T STROKES
TEN00935	0,08	5031538	J / E 10, 15 HP		✓



ZN	KG (kg)	OEM		
TEN00905	0,44	338742	OMC 55 HP	



ZN	KG (kg)	OEM		
TEN00936	0,05	5033167	J / E	



ZN	KG (kg)	AL	KG (kg)	OEM		2T STROKES	4T STROKES
TEN00926	0,51	TEN00926AL		5034616 5030907	EVINRUDE		✓
					40 - 70 HP		



ZN	 (kg)	OEM		2T STROKES	4T STROKES
TEN00927	0,25	5032929	EVINRUDE 70 HP		✓



ZN	 (kg)	OEM	
TEN00912	0,08	173029 123009 327606	JOHNSON 2 - 150 HP



KITS

new

ZN	 (kg)	
TENKITOMC-50-75		

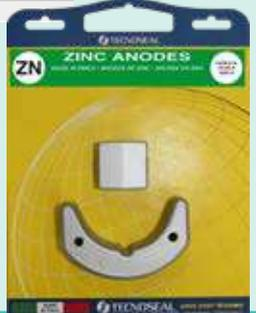

new

ZN	 (kg)	
TENKITOMC-V4-V6		



TORNILLO INOX

SS SCREW

new

REF	OEM	ÁNODO ANODE ANODO ANODE
PAGB/T5783-M6X14	5036691	CM55321-87J00 CM11130-94600 TEN01213 TEN01205



VITE INOX

VIS INOX

new

REF	OEM	ÁNODO ANODE ANODO ANODE	
REC09116-06094	5030034 5030035 5030036	55321-93J00	6 X 15



new

REF	OEM	ÁNODO ANODE ANODO ANODE	
REC09116-06121	5030391 5032502	55321-94900	6 X 25



JUNTA TÓRICA

O-RING

O-RING

JOINT TORIQUE

new

REF	OEM	ÁNODO ANODE ANODO ANODE
REC09280-22019	5035305	CM55321-87J00 TEN01213



JUNTA TAPA DEL ÁNODO

GASKET, ANODE COVER

GUARNIZIONE,
COPERCHIO ANODO

JOINT, COUVERCLE
D'ANODE

new

REF	OEM	
REC11265-87E10	5030623	



PARTES DEL MOTOR ENGINE PARTS

PARTI MOTORE PIECES MOTEUR

DESPIECE MOTOR DE 4
TIEMPOS

ENGINE PARTS
4 STROKES

PARTI MOTORI
4 TEMPI

PIECES MOTEURS DE 4
TEMPS

4T J/BJ 40, 50 HP
STROKES

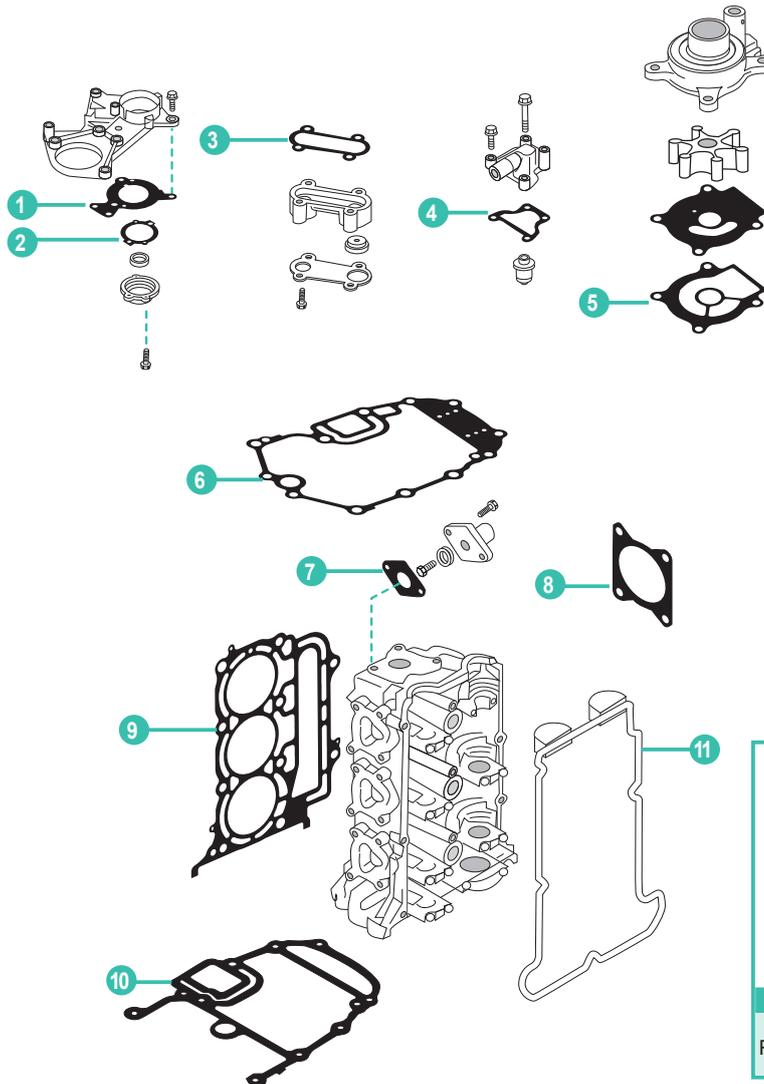

REF	OEM
REC11400-87804	5034354 5036714 5031302

P. 484

	REF	OEM				
1	REC11413-87J00	5031304	RETÉN SUPERIOR	SEAL UPPER	PARAOLIO SUPERIORE	JOINT SPI
2	REC11433-87J00	5031306	JUNTA DEL RETÉN SUPERIOR	SEAL UPPER, GASKET	GUARNIZIONE PARAOLIO SUPERIORE	JOINT
3	REC17616-87J00	5031426	JUNTA DE LA VÁLVULA DE PRESIÓN	PRESURE VALVE, GASKET	GUARNIZIONE, VALVOLA PRESIONE	JOINT SOUPAPE DE PRESSION
4	REC17685-87D10	5031430	JUNTA TAPA DE TERMOSTATO	THERMOSTAT COVER GASKET	GUARNIZIONE COPERCHIO TERMOSTATO	JOINT LOGEMENT THERMOSTAT
5	REC17472-96303	503681	JUNTA DE LA BOMBA DE AGUA	WATER PUMP, GASKET	GUARNIZIONE POMPA ACQUA	JOINT POMPE À EAU
6	REC11489-87J00	5031307	JUNTA DEL CÁRTER	OIL PAN, GASKET	GUARNIZIONE COPPA OLIO	JOINT DE CARTER
7	REC11265-87E10	5030623	JUNTA TAPA DEL ÁNODO	GASKET, COVER ANODE	GUARNIZIONE COPERCHIO ANODO	JOINT D'ANODE D'ÉCHAPPEMENT
8	REC13421-87J00	5031390	JUNTA DEL CUERPO DE MARIPOSA	THRPTTLE BODY GASKET	GUARNIZIONE CORPO FARFALLATO	JOINT DE THROTTLE BODY
9	REC11141-87J02	5031293	JUNTA DE CULATA	CYLINDER HEAD, GASKET	GUARNIZIONE TESTATA	JOINT DE CULASSE
10	REC51211-87J00	5031523	JUNTA BASE MOTOR	GASKET ENGINE	GUARNIZIONE BASE MOTORE	JOINT DE TÊTE MOTRICE
11	REC11189-87J00	5031297	JUNTA TAPA DE BALANCÍN	GASKET CYLINDER COVER	GUARNIZIONE COPERCHIO PUNTERIE	JOINT COUVERCLE

JUNTAS DE MOTOR
4 TIEMPOS

ENGINE GASKET
4 STROKES

GUARNIZIONI DE
MOTORE 4 TEMPI

JOINTS DE MOTEUR
4 TEMPS

4T
STROKES

JUNTAS DE CULATA

CYLINDER HEAD GASKET

GUARNIZIONE DE TESTATA

JOINTS DE CULASSE

REF	OEM	
REC11141-97J02	5037490	2 HP



REF	OEM	
REC11141-87J02	5031293 5034353	J/BJ 40, 50 HP

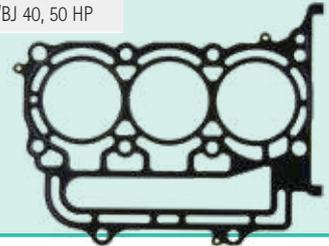

new

REF	OEM	
REC11141-91JL0	5033342	J4, 5, 6 HP



new

REF	OEM	
REC11141-90J01	5033639	90 & 115 HP

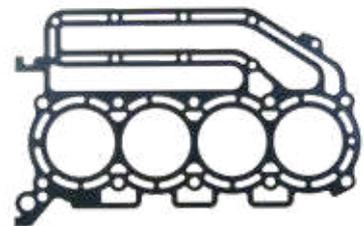

REF	OEM	
REC11141-95J00	5036802	25 HP



REF	OEM	
REC11141-92J01	5034644	140 HP

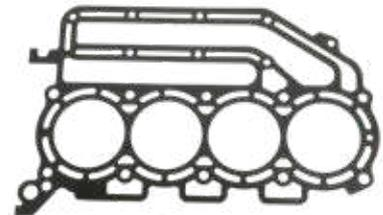

REF	OEM	
REC11141-93E20	5033046	9.9 & 15 HP



REF	OEM		
REC11142-93J10	5035971	200 & 225 HP	PORT
REC11141-93J10	5036629	200 & 225 HP	STB



4T
STROKES

GUÍA
JUNTAS DE CULATA

CYLINDER GASKET
GUIDE

GUIDA
GUARNIZIONE TESTATA

GUIDE
JOINTS DE CULASSE

	RO/OEM	REF	ESTRIBOR STB TRIBORDO DROIT	BABOR PORT BABORDO GAUCHE
J2R4SUC	2007 5037490	REC11141-97J02		
J10	2002-04 5033046	REC11141-93E20		
J15	2002-04 5033046	REC11141-93E20		
J/BJ25	2006-07 5036802	REC11141-95J00		
J90/BJ90	2003-06 5033639	REC11141-90J01		
J115/BJ115	2003-06 5033639	REC11141-90J01		
J140/BJ140	2004-05 5034644	REC11141-92J01		
BJ200	2006 5036629-5035971		REC11141-93J10	REC11142-93J10
BJ225	2006 5036629-5035971		REC11141-93J10	REC11142-93J10

4T
STROKES

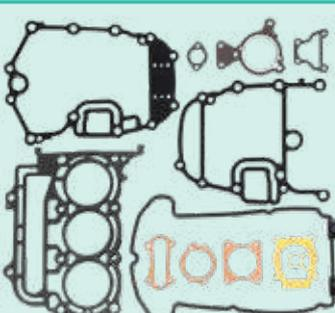
KITS JUNTAS DE CULATA		CYLINDER HEAD GASKET KIT	KIT GUARNIZIONE TESTATA	KITS JOINTS DE CULASSE
REF	OEM			
REC11400-87804	5034354 5036714 5031302			
		new		

4T
STROKES

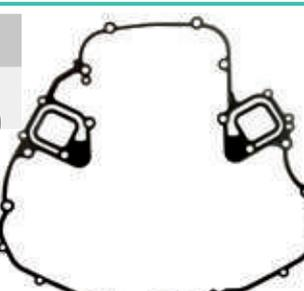
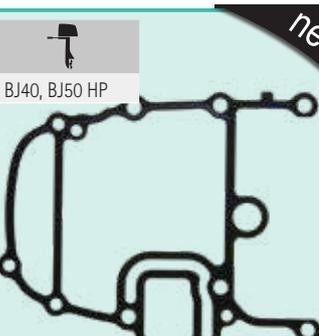
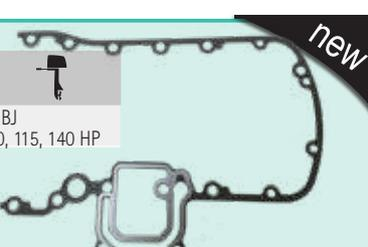
JUNTAS BASE DE MOTOR		CYLINDER GASKET	GUARNIZIONE BASE MOTORE	JOINTS DE TÊTE MOTRICE	
REF	OEM		REF	OEM	
REC51142-93J00	5035135		J/BJ200 J/BJ225 (2004-06)	REC51211-90J10	
REF	OEM		REF	OEM	
REC51211-93J00	5035138		J/BJ200 J/BJ225 (2004-06)	REC51211-87J00	
REF	OEM		new		
REC51211-90J2	5037205		J, BJ 90, 115, 140 HP	<p>Motores modernos New engines Motore moderno Moteurs modernes</p>	

4T
STROKES

JUNTA TAPA DE BALANCINES		GASKET, CYLINDER COVER	GUARNIZIONE COPERCHIO PUNTERIE	JOINT DE CACHE CULBUTEUR
REF	OEM		new	
REC11189-87J00	5031297		J/BJ 40, 50 HP	

4T
STROKES

JUNTA TAPA DE TERMOSTATO		GASKET, THERMOSTAT COVER	GUARNIZIONE COPERCHIO TERMOSTATO	JOINT LOGEMENT THERMOSTAT
REF	OEM		new	
REC17685-87D10	5031430		J/BJ 40, 50 HP	

4T STROKES JUNTA VÁLVULA DE PRESION GASKET, PRESSURE VALVE GUARNIZIONE VALVOLA PRESSIONE JOINT SOUPAPE DE PRESSION

REF	OEM	
REC17616-87J00	5031426	J/BJ 40, 50 HP



4T STROKES JUNTA RETÉN SUPERIOR GASKET, UPPER SEAL GUARNIZIONE PARAOLIO SUPERIORE JOINT SPI SUPERIEUR

REF	OEM	
REC11413-87J00	5031304 5032428	J/BJ 40, 50 HP



REF	OEM	
REC11433-87J00	5031306	J/BJ 40, 50 HP



4T STROKES JUNTAS CUERPO DE MARIPOSA GASKET, THROTTLE BODY GUARNIZIONE CORPO FARFALLATO JOINT DE THROTTLE BODY

REF	OEM	
REC13421-87J00	5031390	J/BJ 40, 50 HP



CIGÜEÑAL CRANKSHAFT ALBERO MOTORE VILEBREQUIN

REF	OEM	
REC0334665	334665	60 (1989-92) 65 COM (1989-92) 70 (1989-95)



BIELAS CONNECTING ROD BIELLA BIELLE

REF	OEM	
REC5004705	394488	V4 Loopcharged, V6



REF	OEM	
REC395861	395861	30 HP (1999-01) 40 HP (1985-02) 45 HP (1986-87, 1990-97) 48 HP (1987-96) 50 HP (1985-02) 55 HP (1985-96, 1999-01) 60 HP (1985)



REF	OEM	
REC394462	394462	40 HP (1999-01) 50 HP (1995-98) 60 HP (1989-01) 70 HP (1986-01)



KIT RETENES OIL SEALS SETS KIT PARAOLIO KIT JOINT SPI

REF	OEM	
REC18-4332	9.9 - 15 HP	



REF	OEM	
REC18-8355	20 - 30AC, TE, E (1990) 20 35R / 25 COM (1990) 25, 28, 32R, TE, RE (1991-92) 20 - 35 R, 25, 30TE, 20 -30E (1996) 20 - 30AC, E, 25 COM, 28 (1994-96)	



REF	OEM	
REC18-4329	20 HP (1981-89) 25 HP (1977-89) 28 HP (1986-88) 30 HP (1984-89) 35 HP (1976-89)	



REF	OEM	
REC18-4331	CrossFlow V4 - V6	



REF	OEM	
REC18-4330	40 - 75 HP	



RETENES OIL SEALS PARAOLIO JOINT SPI

REF	OEM	
REC340559	340559 034559 0778417	E/J 40 HP - 200 HP (1994+)



REF	OEM	
REC328603	328603	20, 35 HP CROSSFLOW (1985-05)



new

REF	OEM	
REC398051	398051	20, 35 HP (1976-05)



new

GUÍA RETENES

CRANKSHAFT GUIDE

GUIDA PARAOLIO

GUIDE JOINTS SPI

		1	2	
9.9	1974-83		REC321831	1
9.9	1984-95		REC321831	1
			REC321788	1
10	1981		REC321831	
10	1989		REC321831	1
			REC321788	1
14	1988-90		REC321831	1
			REC321788	1
15	1974-83		REC87670	1
15	1984-95		REC321831	1
			REC321788	1
18	1957	REC321467	1	
18	1958-73	REC767970	1	
25	1969-76	REC767970	1	
40	1960-61	REC767970	1	
40	1974-76	REC321895	1	REC330137 1
40 C	1981-86	REC321895	1	REC330137 2
40	1984-85	REC321895	1	REC330137 1
40 (AR,AE,AT)	1988	REC321895	1	
40	1986-89	REC321895	1	
45 C	1985-95	REC321895	1	
48	1988-95	REC321895	1	REC330327 1
50	1971-80	REC321895	1	REC330137 1
50/60	1981-89	REC321895	1	REC330137 1
50	1990-95	REC321895	1	REC330327 1
55	1968-69	REC321895	1	REC330137 1
55, 55 C	1976-85	REC321895	1	REC330137 1
55 C	1986-95	REC321895	1	
60	1970	REC321895	1	REC330137 1
60 (3-Cyl.)	1971	REC321895	1	REC330137 1
60	1980-83	REC321895	1	REC330137 1
60 SST	1989	REC321895	1	REC330137 1
60 SST	1990	REC321895	1	
60 (3-Cyl.)	1987-95	REC321895	1	
65 (Manual)	1968	REC321895	1	
65 (3-Cyl.)	1972-73	REC321895	1	REC330137 1
65 C	1984-89	REC321895	1	REC330137 1
70 (Large)	1974-85	REC321895	1	REC330137 1
70 (Large)	1986-95	REC321895	1	

		1	2	
70 (Small)	1977-85	REC321895	1	
75 (Large)	1975-87	REC321895	1	
75 (Small)	1975-84	REC321895	1	REC330137 1
85	1969-72	REC339620	1	REC330137 1
85	1973-80	REC339620	2	REC330137 1
88	1987-94	REC339620	2	
90	1981-83	REC339620	2	REC330137 1
90	1984-94	REC329923	1	
90 Seadrive	1985-90	REC339620	2	REC330137 1
100	1971-72	REC339620	1	REC330137 1
100	1979-80	REC339620	2	REC330137 1
100 C	1984-90	REC339620	2	
110	1986-88	REC339620	2	REC330137 1
115	1969-83	REC339620	1	REC330137 1
115	1984-85	REC339620	2	REC330137 1
115	1990-94	REC339620	2	
120	1985-94	REC339620	2	REC353076 2
125	1971-72	REC339620	1	REC330137 1
125 C	1989	REC339620	2	REC353076 1
125 C (ESX)	1989	REC329923	1	REC353076 1
135	1973-76	REC339620	2	REC330137 1
140	1977-84	REC339620	2	REC330137 1
140	1985-94	REC339620	2	REC353076 2
140 TX	1989	REC339620	2	REC353076 2
150	1978-83	REC339620	2	REC353076 2
150	1984	REC339620	2	
155 C	1984-85	REC339620	2	REC330137 1
155 C	1986-90	REC339620	2	
175	1977-85	REC339620	2	REC330137 1
175	1986-90	REC339620	2	
185	1984-85	REC339620	2	REC330137 1
185	1990	REC339620	2	REC353076 1
200	1976-83	REC339620	2	REC330137 1
200	1984-85	REC339620	2	
200,225	1986-90	REC339620	2	REC353076 2
235	1978-85	REC339620	2	REC330137 1
275	1985-88	REC339620	2	REC353076 2
3.6L, 300	1985-90	REC339620	2	REC353076 2

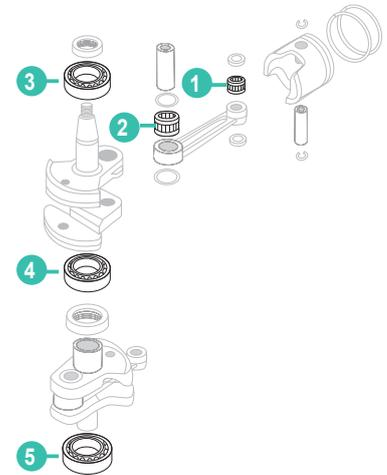
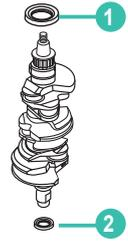

COJINETES PIE DE BIELA

CONNECTING ROD BEARING, SMALL END

CUSCINETTO DI BIELA, FINALE PICCOLO

ROULEMENT PIED DE BIELLE

REF	OEM	
REC395627	395627	20 - 35 HP (1981-95) 45 - 60 (2 Cyl) (1977-95) V4 Crossflow (3 Cyl) (-1973) V6 Crossflow (-1976) V4, V6 60°



REF	OEM	
REC434844	434844	V4, V6, V8 90° LoopedCharged (1985+)



2

COJINETES CABEZA DE BIELLA

CONNECTING ROAD BEARING, BIG END

CUSCINETTO DI BIELLA, FINALE GRANDE

ROULEMENT TÊTE DE BIELLE

REF	OEM			OEM
REC31-17514A2	437088	20 - 35 HP (1976-95) 46 - 60 HP (2 Cyl) (1971-94) 3 Cyl (1968-93) V4 (1961-73)	REC764102	387139 387142



REF	OEM			OEM
REC387787	387787	V4 Crossflow (-1979) V6 Crossflow (-1976) V4-V6 60°	REC764102	387139 387142



REF	OEM		
REC878763	396041	V4, V6, V8 90° LoopedCharged (1985-95)	Ø 1.500



REF	OEM
REC5007190	387041



REF	OEM
REC388344	388344



REF	OEM
REC764102	387139



3

COJINETES SUPERIORES

UPPER BEARING

CUSCINETTO SUPERIORE

ROULEMENT SUPERIEUR

REF	OEM	
REC390900	390900	45 - 60 HP 2 Et 3 Cyl
REC398529	398529	45 - 60 HP (Modernos Late models Moderno Moderne) 2 Et 3 Cyl
REC31-02799	393896	



REC390900

REC398529

REC31-02799

4

COJINETES CENTRALES

CENTER BEARING

CUSCINETTO CENTRALI

ROULEMENT CENTRAL

REF	OEM		
REC395401	395401	9.9 - 15 HP (1974-95) 9.9 - 15 HP (1974-83) 40C (-1974)	Ø 0.8125
REC378252	378252	45 - 60 HP (2 Cyl) (-1971) V4 (3 Cyl) (1962-78)	Ø 1.375
REC5007190	387041	V4 Crossflow (-1979) V6 Crossflow (-1976) V4-V6 60°	Ø 2.1875



REC395401

REC378252

4

REF	OEM	
REC310433	310433	40C (-1974) 45 - 60 HP (2 Cyl) (-1971) V4 (3 Cyl) (1962-78)
REC352960	320499	V4 Crossflow (-1979) V6 Crossflow (-1976) V4-V6 60°



REC310433

REC352960

5

COJINETES INFERIORES

LOWER BEARING

CUSCINETTO INFERIORE

ROULEMENT INFERIEUR

REF	OEM
REC31-02803	385503
REC31-02747	330854
REC31-02806	390641



REF	OEM	
REC377139	377139	3 Cyl (1968-94)

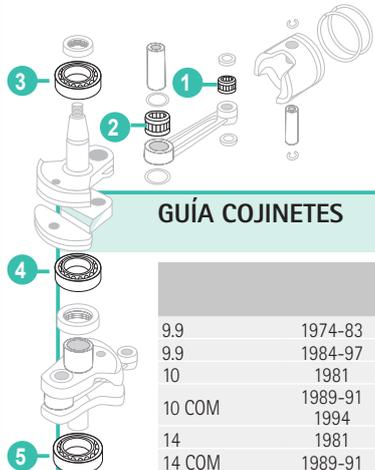

GUÍA COJINETES

GUIDE BEARING

GUIDA CUSCINETTO

GUIDE ROULEMENT

		1	2		3	4		5
9.9	1974-83	REC395627	REC395401			REC395401		
9.9	1984-97	REC395627	REC395401					
10	1981	REC395627	REC395401					
10 COM	1989-91 1994		REC395401					
14	1981		REC395401			REC395401		
14 COM	1989-91	REC395627	REC395401					
15	1974-83	REC395627	REC395401			REC395401		
15	1984-97	REC395627	REC395401					
15 COM	1994	REC395627	REC395401					
18	1970-73	REC395627		REC764102				
18 JET	1996-97	REC395627	REC388344		REC31-02799	REC31-02798		REC31-02747
20	1981-84	REC395627	REC388344	REC764102		REC31-02798		REC31-02747
20	1985-97		REC388344		REC31-02799	REC31-02798		REC31-02747
25	1970-76			REC764102				
25	1977	REC395627	REC388344	REC764102				REC31-02747
25	1978-80	REC395627	REC388344	REC764102		REC31-02798		REC31-02747
25	1981-84		REC388344	REC764102		REC31-02798		REC31-02747
25	1985-97		REC388344		REC31-02799	REC31-02798		REC31-02747
25 COM (NO mod. D)	1982-84		REC388344	REC764102		REC31-02798		REC31-02747
25 COM	1985-97	REC395627	REC388344		REC31-02799	REC31-02798		REC31-02747
28	1987-97	REC395627	REC388344		REC31-02799	REC31-02798		REC31-02747
30	1984		REC388344	REC764102		REC31-02798		REC31-02747
30	1985-97		REC388344		REC31-02799	REC31-02798		REC31-02747
33	1970		REC388344	REC764102				
35	1976-80	REC395627	REC388344	REC764102				REC31-02747
35	1981-84	REC395627	REC388344	REC764102		REC31-02798		REC31-02747
35	1985-97	REC395627	REC388344		REC31-02799	REC31-02798		REC31-02747
40	1971-73	REC395627	REC388344	REC764102				
40	1974-76 1983	REC395627	REC388344	REC764102		REC378252	REC310433	REC377139
40	1984-86	REC395627	REC388344		REC390900	REC378252	REC310433	REC377139
40	1987-97	REC395627	REC388344		REC398529	REC378252	REC310433	REC377139
40 COM	1982-83	REC395627	REC388344			REC378252	REC310433	REC377139
40 COM	1984-85	REC395627	REC388344		REC390900	REC378252	REC310433	REC377139
40 COM	1989-90	REC395627	REC388344		REC398529	REC378252	REC310433	REC377139
40 COM	1994	REC395627	REC388344		REC398529	REC378252	REC310433	
40 COM	1995-00	REC395627			REC398529	REC378252	REC310433	
45 COM	1985-86 1987-94	REC395627	REC388344		REC390900	REC378252	REC310433	REC377139
45 COM	1995-97	REC395627			REC398529	REC378252	REC310433	
45 SS	1987-90	REC395627	REC388344		REC390900	REC378252	REC310433	REC377139
48	1987	REC395627	REC388344		REC390900	REC378252	REC310433	REC377139
48	1988-96	REC395627	REC388344		REC398529	REC378252	REC310433	REC377139
50	1979-83	REC395627	REC388344	REC764102	REC390900	REC378252	REC310433	REC377139

		1	2		3	4		5
50	1984-86	REC395627	REC388344		REC390900	REC378252	REC310433	REC377139
50 (2 Cyl)	1987-00	REC395627	REC388344		REC398529	REC378252	REC310433	REC377139
50 (3 Cyl)	1995-00	REC395627			REC398529	REC378252	REC310433	REC377139
55	1976-81		REC388344	REC764102	REC390900	REC378252	REC310433	REC377139
55 COM	1982	REC395627	REC388344	REC764102	REC390900	REC378252	REC310433	REC377139
55 COM	1983-86	REC395627	REC388344		REC390900	REC378252	REC310433	REC377139
55 COM	1987-94	REC395627	REC388344		REC398529	REC378252	REC310433	REC377139
55 COM	1995-00	REC395627			REC398529	REC378252	REC310433	
60	1980-83		REC388344	REC764102	REC390900	REC378252	REC310433	REC377139
60	1984-85	REC395627	REC388344		REC390900	REC378252	REC310433	REC377139
60	1986-90							
60	1991-93	REC395627	REC388344		REC398529	REC378252	REC310433	REC377139
60	1994-01	REC395627			REC398529	REC378252	REC310433	REC377139
SST-60	1989-90		REC388344		REC390900	REC378252	REC310433	REC377139
65	1972-73	REC395627	REC388344	REC764102	REC390900	REC378252	REC310433	REC377139
65 COM	1984	REC395627	REC388344	REC764102	REC390900	REC378252	REC310433	REC377139
65 COM	1985-90	REC395627	REC388344		REC390900	REC378252	REC310433	REC377139
65 COM	1991-93		REC388344		REC398529	REC378252	REC310433	
65 COM	1994-01	REC395627			REC398529	REC378252	REC310433	
70	1974-75	REC395627	REC388344	REC764102	REC390900	REC378252	REC310433	REC377139
70	1976-84							
70	1985-90	REC395627	REC388344		REC390900	REC378252	REC310433	REC377139
70	1991-93	REC395627	REC388344		REC398529	REC378252	REC310433	REC377139
70	1994-97	REC395627			REC398529	REC378252	REC310433	REC377139
75	1975		REC388344	REC764102	REC390900	REC378252	REC310433	REC377139
75	1976-84	REC395627	REC388344	REC764102	REC390900	REC378252	REC310433	REC377139
75	1985-88	REC395627	REC388344		REC390900	REC378252	REC310433	REC377139
80 JET	1992-98	REC395627	REC387787		REC390900	REC5007190	REC352960	REC31-02803
85	1968-72	REC395627	REC388344	REC764102		REC378252	REC310433	REC377139
85	1973	REC395627	REC388344	REC764102		REC378252	REC310433	REC31-02803
85	1974-78	REC395627	REC387787			REC378252	REC310433	REC31-02803
85	1979-80	REC395627	REC387787			REC5007190	REC352960	REC31-02803
85	1991-95							
88	1987-96	REC395627	REC387787		REC5007190	REC352960	REC31-02803	REC31-02803
90 (90° V)	1981-03		REC387787		REC5007190	REC352960	REC31-02803	REC31-02803
90 (60° V)	1995-03	REC395627	REC387787		REC5007190	REC352960		
90 JET	1994-95	REC434844	REC387787		REC5007190	REC352960	REC31-02803	REC31-02803
100	1979-80		REC387787		REC5007190	REC352960	REC31-02803	REC31-02803
100	1990-94	REC434844	REC387787		REC5007190	REC352960	REC31-02803	REC31-02803
100 COM	1984-05	REC434844	REC387787		REC5007190	REC352960	REC31-02803	REC31-02803
110	1986-89	REC434844	REC387787		REC5007190	REC352960	REC31-02803	REC31-02803
115	1994-96	REC395627	REC387787		REC5007190	REC352960	REC31-02803	REC31-02803
115	1974-78	REC395627	REC387787		REC378252	REC310433	REC31-02803	REC31-02803
115	1979-85	REC395627	REC387787		REC5007190	REC352960	REC31-02803	REC31-02803
115 (90° V)	1990-06	REC434844	REC387787		REC5007190	REC352960	REC31-02803	REC31-02803
115 (60° V)	1995-06	REC395627	REC387787		REC5007190	REC352960		
115 JET	1994-06		REC387787		REC5007190	REC352960	REC31-02803	REC31-02803
120	1985-94		REC878763		REC5007190	REC352960	REC31-02806	REC31-02806
125	1971-72	REC395627	REC388344	REC764102	REC378252	REC310433	REC377139	
125 COM	1989-95	REC395627	REC878763		REC5007190	REC352960	REC31-02806	REC31-02806
125 ESX	1991-94		REC878763		REC5007190	REC352960	REC31-02806	REC31-02806
130	1994-00	REC395627	REC878763		REC5007190	REC352960	REC31-02806	REC31-02806
135	1974-76	REC434844	REC387787		REC378252	REC310433	REC31-02803	REC31-02803
140	1977-78	REC395627	REC387787		REC378252	REC310433	REC31-02803	REC31-02803
140	1979-84	REC434844	REC387787		REC5007190	REC352960	REC31-02803	REC31-02803
140	1985-94	REC434844	REC878763		REC5007190	REC352960	REC31-02806	REC31-02806
150	1978-91	REC434844	REC387787	REC764102	REC5007190	REC352960	REC31-02803	REC31-02803
150 (60° V)	1991-06	REC434844	REC387787		REC5007190	REC352960		
150 COM (60° V)	1993-95	REC395627	REC387787		REC5007190	REC352960		
155 COM	1984-92	REC434844	REC387787	REC764102	REC5007190	REC352960	REC31-02803	REC31-02803
175	1977-91	REC434844	REC387787	REC764102	REC5007190	REC352960	REC31-02803	REC31-02803
175 (60° V)	1991-97	REC434844	REC387787		REC5007190	REC352960		
185	1984-85	REC434844	REC387787	REC764102	REC5007190	REC352960	REC31-02803	REC31-02803
185	1990-94	REC434844	REC878763		REC5007190	REC352960	REC31-02806	REC31-02806
200	1976-83		REC387787	REC764102	REC5007190	REC352960	REC31-02803	REC31-02803
200	1986-06		REC878763		REC5007190	REC352960	REC31-02806	REC31-02806
200 COM	1990, 1994		REC878763		REC5007190	REC352960	REC31-02806	REC31-02806
225	1986-06		REC878763		REC5007190	REC352960	REC31-02806	REC31-02806
235	1978-85		REC387787	REC764102	REC5007190	REC352960	REC31-02803	REC31-02803
250	1991-95		REC878763		REC5007190	REC352960	REC31-02806	REC31-02806
250	1997							
275	1985-88		REC878763		REC5007190	REC352960	REC31-02806	REC31-02806
3.6L	1985-87		REC878763		REC5007190	REC352960	REC31-02806	REC31-02806
300	1988-95		REC878763		REC5007190	REC352960	REC31-02806	REC31-02806

PISTONES

PISTONS

PISTONI

PISTONS

DISEÑOS DE PISTONES

PISTON DESIGNS

DISEGNO DEI PISTONI

DESSIN DES PISTONS

Existen tres tipos de diseño diferentes utilizados en los motores Johnson-Evinrude: Crossflow, Loopcharged y 4 Tiempos.

There are three basic piston designs used in Johnson / Evinrude outboard engines: Crossflow, Loopcharged and Four-Stroke.

Esistono tre tipi di disegni diversi utilizzati nei motori Johnson-Evinrude: Crossflow, Loopcharged e 4 Tempi.

Il existe trois types de dessin différents utilisés sur les moteurs Johnson-Evinrude: Crossflow, Loopcharged et 4T

CROSSFLOW

Mientras la mezcla de aire y combustible circula a través del cilindro, un deflector dirige la mezcla hacia la cámara de combustión.

As the air / fuel mixture travels through the transfer port and into the cylinder, a deflector, cast into the top of the piston, directs the air / fuel mixture towards the combustion chamber.

Mentre la miscela d'aria e il combustibile circolano attraverso il cilindro il deflettore del pistone dirige la miscela verso la camera di combustione.

Lorsque le mélange air-carburant circule dans le cylindre, un déflecteur dirige le mélange dans la chambre de combustion.

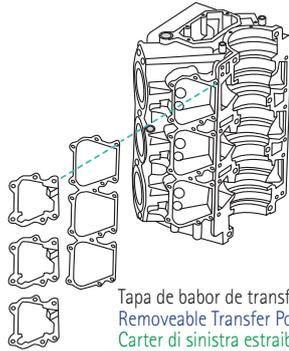

Tapa de babor de transferencia desmontable
Removeable Transfer Port Cover
Carter di sinistra estraibile
Couvercle gauche de transfert démontable



Pistón con deflector
Piston with Deflector Top
Pistone con deflettore
Piston avec déflecteur

LOOPCHARGED

El motor loopcharged tiene una toma de transferencia en la pared del cilindro, de tal forma que dirige la mezcla de aire y combustible hacia la cámara de combustión, arrancando así, sin la necesidad de un deflector.

A loopcharged engine has a transfer port cast into the cylinder wall in such a way that it will direct the air / fuel mixture towards the combustion chamber and spark plug tip without the need for a piston deflector.

Aspirazione nella parete del cilindro in maniera tale da dirigere la miscela d'aria e combustibile verso la camera di combustione, non avendo così la necessità di convogliare la combustione con il deflettore.

Le moteur Loopcharged a un orifice de transfert dans la paroi du cylindre, de telle sorte qu'il dirige le mélange d'air et de carburant vers la chambre de combustion, démarrando ainsi, sans avoir besoin d'un déflecteur.

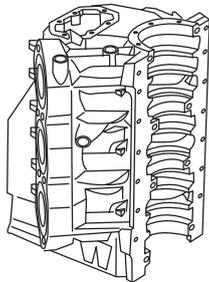

Tapa de babor de transferencia fija
Non-Removeable Transfer Port Cover
Carter di sinistra fisso
Couvercle gauche de transfert fixe



Pistón con tapa plana
Piston with Flat Top
Pistone con testa piana
Piston à tête plate

4 TIEMPOS

Los motores de 4 tiempos son bastante nuevos en la industria náutica. Son los favoritos de la mayoría de los fabricantes pues respetan las leyes sobre el medio ambiente. El aceite almacenado en el cárter de estos motores sale disparado hacia las paredes de los pistones y sus aros para su lubricación.

4 STROKES

Four-stroke / four-cycle engines are fairly new to the marine industry. They have become the engine design preferred by most marine engine manufacturers to meet government mandated exhaust emission standards. Oil stored in the crankcase of these engines is splashed onto the cylinder walls for piston and ring lubrication.

4 TEMPI

I motori a 4 tempi sono abbastanza nuovi nell' industria nautica. Sono i preferiti dalla maggior parte dei fabbricanti perchè rispettano le leggi sull' ambiente. L'olio è immagazzinato nel carter di questi motori e scorre nelle pareti dei pistoni e delle fasce per la lubrificazione.

4 TEMPS

Les moteurs à 4 temps sont relativement nouveaux dans l'industrie maritime. Ils sont les favoris de la plupart des fabricants car ils respectent les lois sur l'environnement. L'huile stockée dans le carter de ces moteurs jaillit vers les parois des pistons et leurs segments pour la lubrification.



Pistón con tapa plana y aro de aceite en la parte inferior
Piston with Flat Top and Oil Ring in the Bottom Position
Pistone con testa piana e paraolio
Piston avec tête plate et bague d'huile en bas

KITS DE PISTONES
AROS , PASADORES, BULÓN

PISTON KITS
RINGS, PIN AND CIRCLIP

KIT PISTONE
FASCE, SPINOTTO E CLIP

KIT PISTON
SEGMENTS, AXE ET CLIPS

CROSSFLOW

	STD (2.188")		0.30 (2.188")		
	REF	OEM	REF	OEM	
	REC5006670	5006670	REC5006662	5006662	(2 Cyl) 9.9 HP (1981-92) 15 HP (1981-92)
	REC386918	386279	REC386280	386280	



	STD (3.000")		0.30 (3.030")		
	REF	OEM	REF	OEM	
	REC5006657	5006657	REC5006664	5006664	(2 Cyl) 20 HP (1981-83) 25 HP (1986-94) 30 HP (1984-94)
	REC396377	396377	REC396379	396379	



	STD (3.500")		0.30 (3.530")		
	REF	OEM	REF	OEM	
	REC5006658	5006658	REC5006669	5006669	V4 85 HP (1979-80) 88 HP (1987-93) 90 HP (1981-93) 100 HP (1984-94) 110 HP (1986-90) 115 HP (1973-85) 135 HP (1974-76) 140 HP (1977-84) 150 HP (1978-91) 175 HP (1977-85) 185 HP (1984-85) 200 HP (1976-83) 235 HP (1978-79)
	REC394930	394930	REC396504	396504	



	STD (3.625")		0.30 (3.655")		
	REF	OEM	REF	OEM	
			REC5006668	5006668	V4 175 HP (1986-91) 235 HP (1980-85)
	REC390509	390509	REC390510	390510	



LOOPCHARGED

	STD (3.187")		0.30 (3.217")		
	REF	OEM	REF	OEM	
	KIT REC435546	5006655			(2 Cyl) 40 HP (1984-94) 45 HP (1994) 48 HP (1987-94) 50 HP (1981-94) 55 HP (1994) 60 HP (1980-85)
	REC391170	391170	REC391416	391416	



	STD (3.000")		0.30 (3.030")		
	REF	OEM	REF	OEM	
	REC5006751	5006751	REC5006666	5006666	(3 Cyl) 60 HP (1986-88) 65 HP COM (1984-86) 70 HP (1976-85) 75 HP (1976-88)
	REC396377	396377	REC396379	396379	



	STD (3.187")		0.30 (3.217")		
	REF	OEM	REF	OEM	
	REC5006701	5006701	REC5006702	5006702	(3 Cyl) 50 HP (1995-98) 60 HP (1989-94) 65 HP (1987-94) 70 HP (1986-94)
	REC391170	391170	REC391416	391416	



	STD (3.685")		STD 0.30 (3.715")		PORT 0.30 (3.715")		
	REF	OEM	REF	OEM	REF	OEM	
			REC5006713	5006713	REC5006711	5006711	OCEAN PRO/RUNNER 90° 200 HP / 225 HP (1993-01) Con carburadores With carburetors Con carburatori Avec carburateur
	REC436254	436254					



	STD (3.1875")		
	REF	OEM	
	REC5006694	5006694	(3 Cyl) 60 HP (1994-01) 65 HP (1994-01) 70 HP (1994-01)
	REC436972	436972	



	REF	OEM	STD	
REC396504	396504	3.530"	V8 275 HP (1985-87) V8 300 HP (1985-87)	
REC431870	431870	3.685"	V4 120 HP 90° (1988-94) V4 140 HP 90° (1988-94) V6 200 HP (1988-92) V6 225 HP (1988-92) V8 275 HP (1991-98) V8 300 HP (1988-95)	

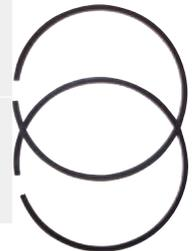

4T SERIE EAGLE / JET EAGLE

STROKES

	STD (3.600")		STD 030 (3.630")		PORT (3.600")		PORT 030 (3.630")		
	REF	OEM	REF	OEM	REF	OEM	REF	OEM	
	REC5006688	5006688	REC5006716	5006716	REC5006687	5006687	REC5006714	5006714	V4 60° 90 HP (1995-06) V6 60° 115 HP (1995-06) JET EAGLE V4 60° 105 HP (1993-97) JET EAGLE V6 60° 150 HP (1991-06) 175 HP (1991-06)
	REC436353	436353			REC436353	436353			



4T SERIE FITCH

STROKES

	STD (3.600")		PORT (3.600")		STD 030 (3.630")		
	REF	OEM	REF	OEM	REF	OEM	
	REC5006728	5006728	REC5006727	5006727	REC5006730	5006730	75, 90, 115, 150, 175 HP 60° (2000+)
	REC436353	436353	REC436353	436353			



2T
STROKES

JUNTAS DE MOTOR 2 TIEMPOS	ENGINE GASKET 2 STROKES	GUARNIZIONI MOTORE 2 TEMPI	JOINTS DE MOTEUR 2 TEMPS
------------------------------	----------------------------	-------------------------------	-----------------------------

JUNTAS DE CULATA	CYLINDER HEAD GASKET	GUARNIZIONE DE TESTATA	JOINT DE CULASSE
------------------	----------------------	------------------------	------------------

REF	OEM
REC313782	313782



REF	OEM
REC802307	332010



REF	OEM
REC329419	329419



REF	OEM
REC802288	325273



REF	OEM
REC330818	330818



REF	OEM
REC338222	338222



REF	OEM
REC335359	335359 327795



REF	OEM
REC340115	340115



REF	OEM
REC328623	328623



REF	OEM
REC319633	319633



REF	OEM
REC318358	318358



REF	OEM
REC203130	203130



REF	OEM
REC329103	329103



REF	OEM
REC332819	332819



JOHNSON EVINRUDE

RECAMBIOS
MARINOS

REF	OEM
REC307069	307069



REF	OEM
REC878846	313413

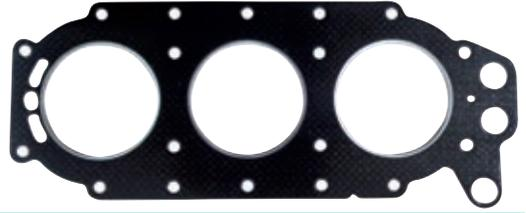

REF	OEM
REC335361	335361 325647



REF	OEM
REC333670	334726 333670



REF	OEM
REC332817	332817



REF	OEM
REC329836	329836



REF	OEM
REC332816	332816

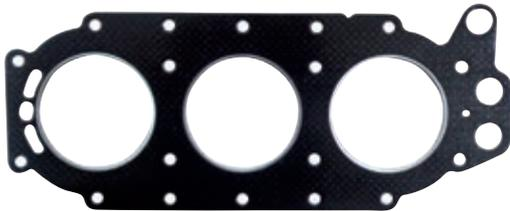

REF	OEM
REC766779	335360 320745



REF	OEM
REC345257	345257



REF	OEM
REC332818	332818



REF	OEM
REC331211	331211



REF	OEM
REC340116	340116 333554



KITS
JUNTAS DE CULATA

**CYLINDER HEAD GASKET
KIT**

REF	OEM	
REC802113	394546	9.9 - 15 HP (1984-92)



REF	OEM	
REC436358	436358	9.9 - 15 HP (1993-99)



REF	OEM	
REC802133	433941 392567 392615	20 - 30 HP Crossflow (1996-99)

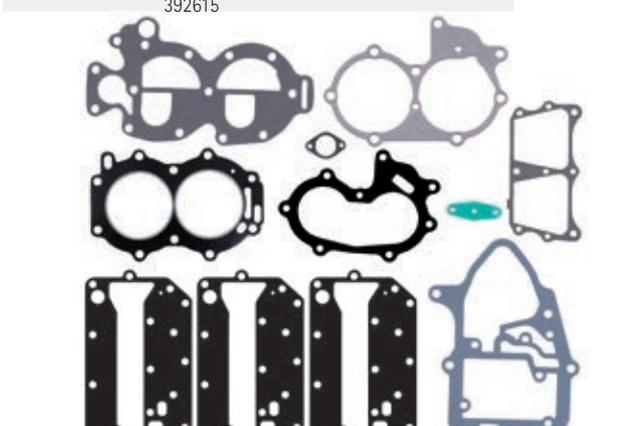

REF	OEM	
REC5005907	5005907	E-TEC (2 cyl en línea inline in linea en ligne) E40 - E65 HP (2004+)

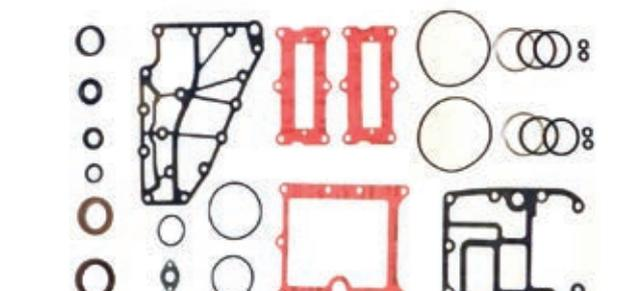

KIT
GUARNIZIONE TESTATA

KITS
JOINT DE CULASSE

REF	OEM	
REC439083	393433 439083	40 - 60 HP (2 cyl) Loopcharged (1998-01)



REF	OEM	
REC39390	398047 438904	60 - 70 HP (3 cyl) (1986-01)



REF	OEM	
REC439084	385416 390078	60 - 75 HP (3 cyl) (1979-88)

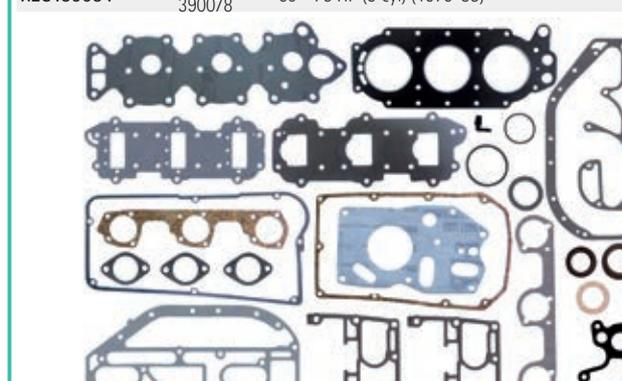

REF	OEM	
REC5005931	5005931	E-TEC (4 cyl en línea inline in linea en ligne) E75, E90 HP (2004+)

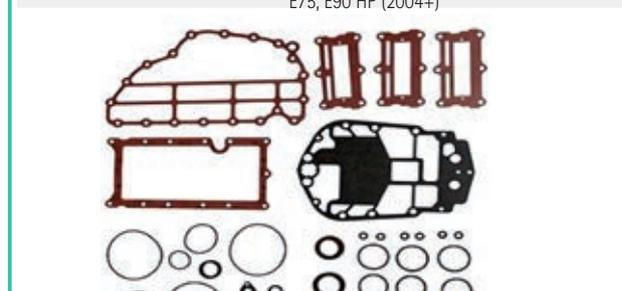

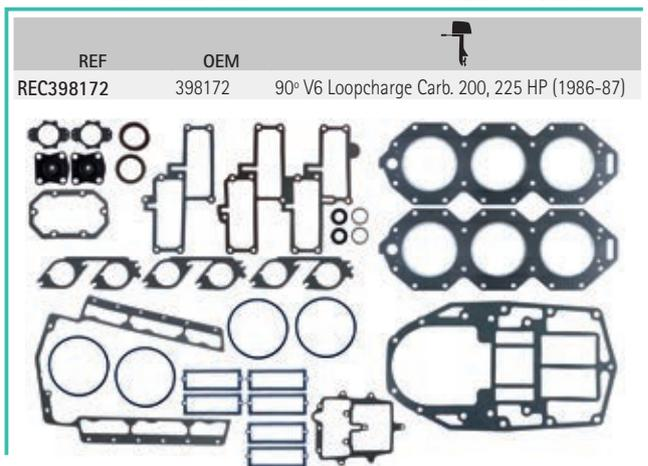
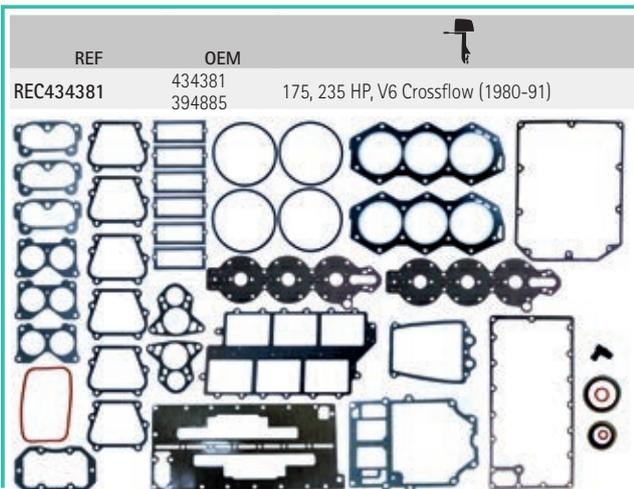
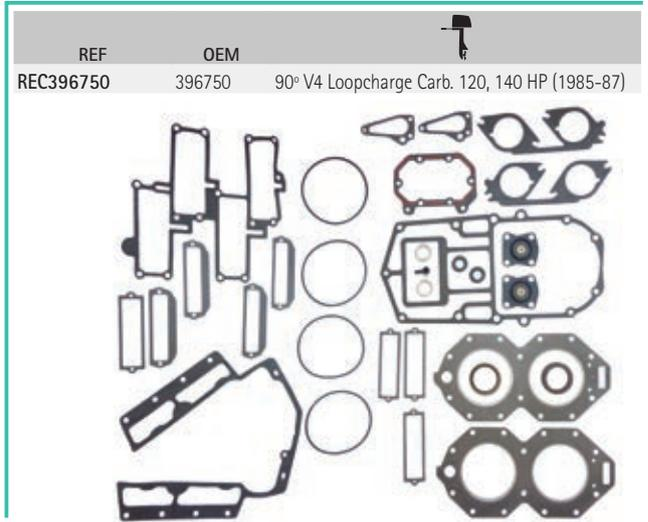
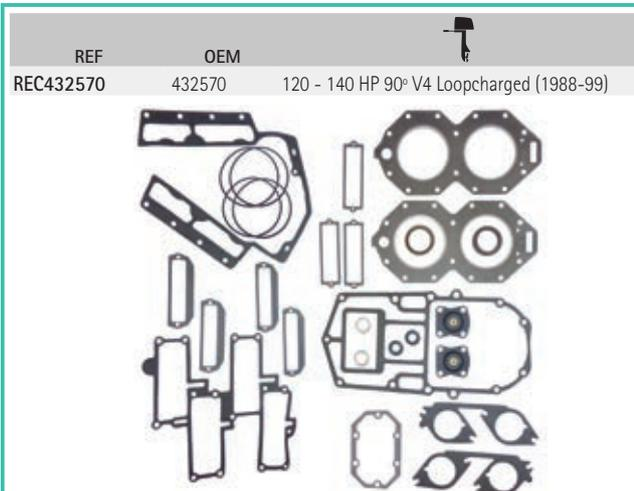
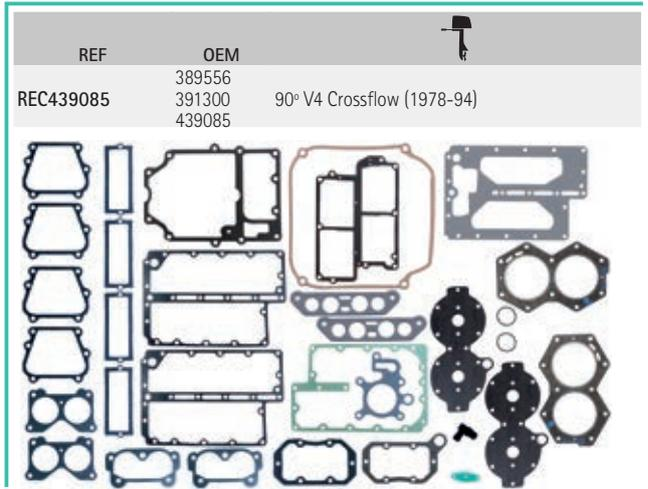
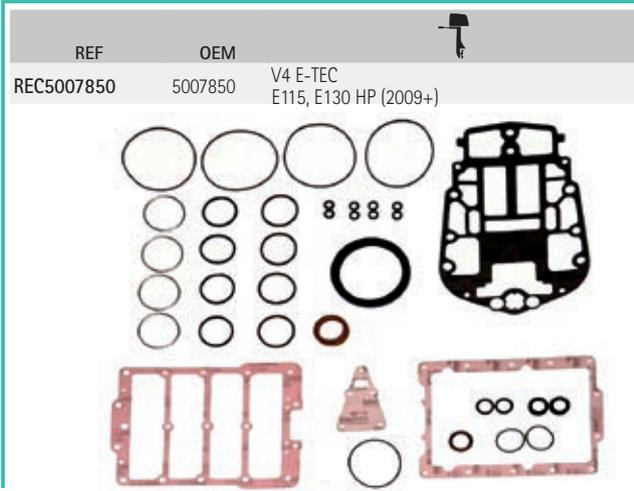
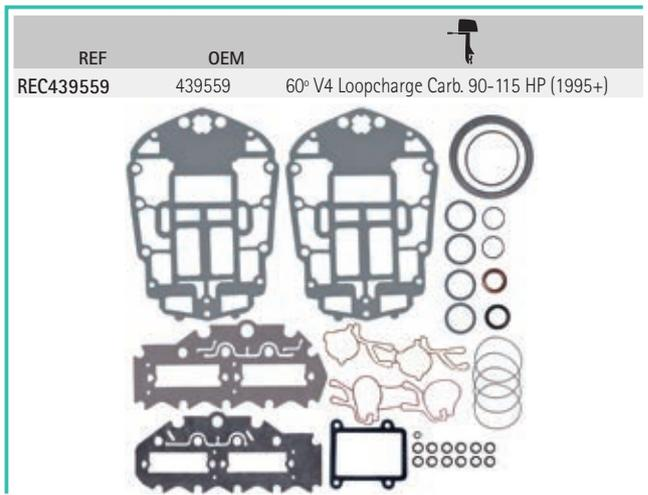
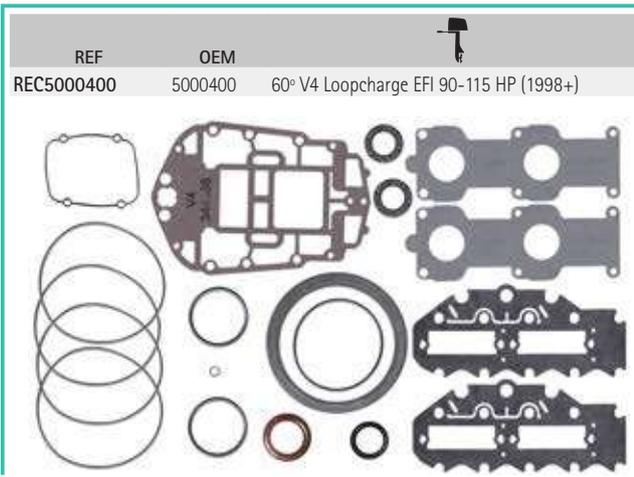

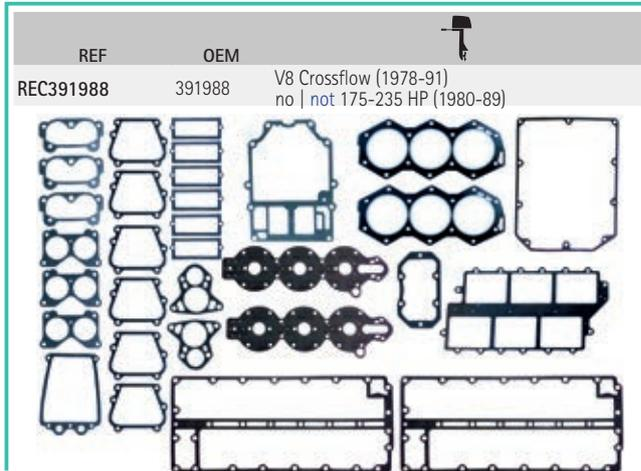
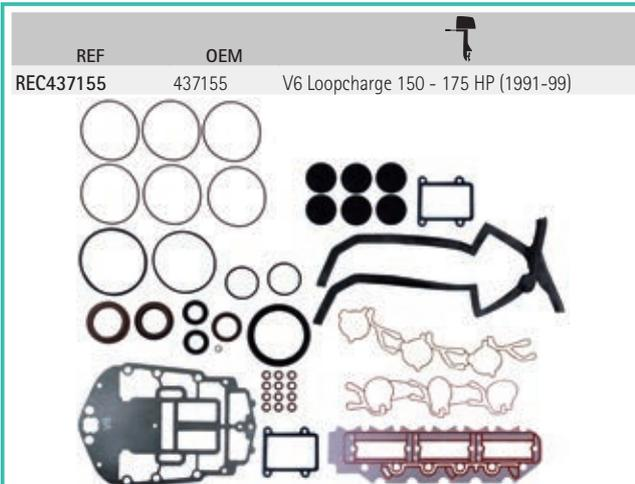
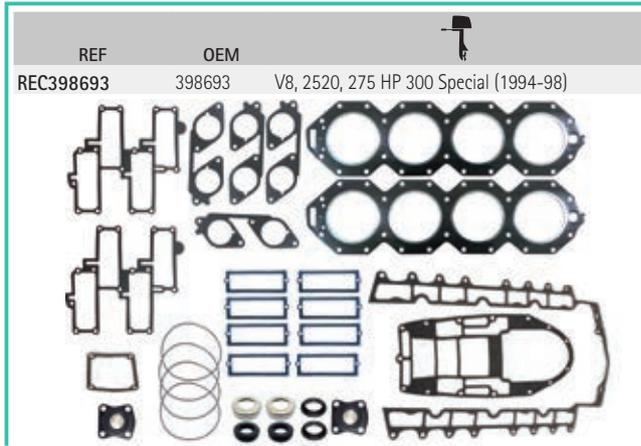
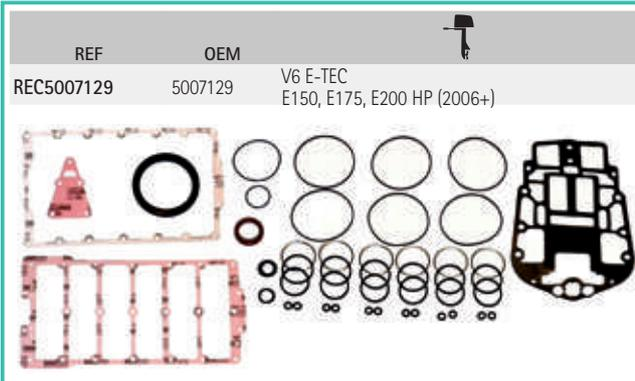
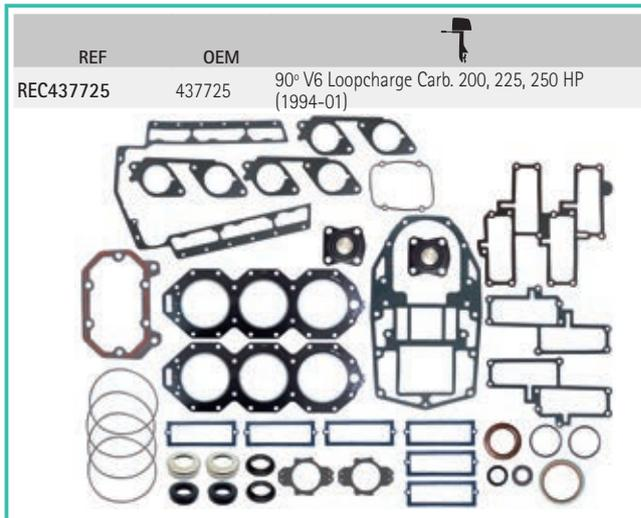
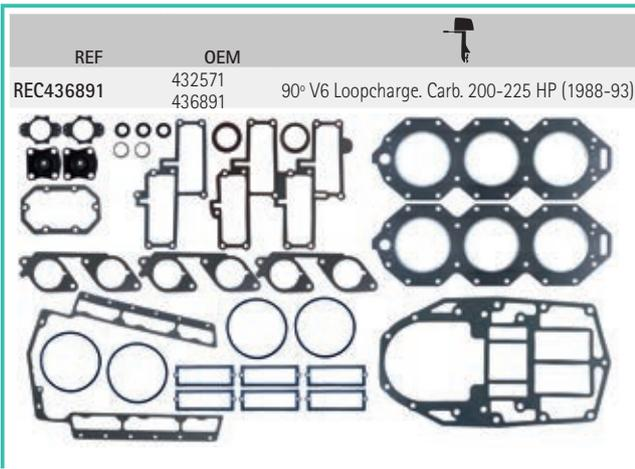

2T
STROKES

GUÍA JUNTAS DE CULATA

CYLINDER HEAD GASKET GUIDE

GUIDA GUARNIZIONE TESTATA

GUIDE JOINTS DE CULASSE

		cyl	KIT	
2 Colt, Junior	1969-90			REC313782
4	1968-80			REC203130
2.5, 3, 4, 4.5, Ultra, Excel 4	1981-98			REC802307
5, 5.5, 6	1959-73			REC329103
6	1980-98			REC802288
9.9, 15	1974-92	2	REC802113	REC330818
9.9, 15	1993-99	2	REC436358	REC338222
20, 25, 28, 30	-1979	2	REC802133	
20, 25, 28, 30, 35 (521 cc)	1979-00			REC329419
35 (521 cc)	1976-78			REC319633
35	1979-86	2	REC802133	
40	1960-76			REC307069
40, 40 COMM (719 cc)	1968-86			REC307069
40, 45, 48, 50, 55, 60 (737 cc)	1976-01			REC335359
40, 45, 48, 55	-1980	2	REC439083	
E40	2004	2	REC5005907	
50	1971-75	2	REC439083	

		cyl	KIT	
55	1976	2	REC439083	
55	1977-79	2	REC439083	
50	1980	2	REC439083	
50	1995	3	REC39390	
55, 60	1980-85	2	REC439083	
55, 60, 65	1968-73			REC878846
60 (814 cc)	1986-89	3		REC878846
60 (913 cc)	1974-85	3		REC878846
60	1986-88	3	REC439084	
60	-1989	3	REC39390	
E60	2004	2	REC5005907	
60, 65	1970-73			REC332816
65	1972-73	3	REC439084 + REC878846	
65	1984-86	3	REC439084	
65	-1987	3	REC39390	
70	1974-85	3	REC439084	

2T
STROKES

		cyl	KIT	
70	-1986	3	REC39390	
70 (814 cc)	1989-01	3		REC329836
70 (913 cc)	1986-01	3		REC329836
75 (814 cc)	1975-89	3		REC878846
75 (814 cc)	1975-78	3		REC332816
75	2004	4	REC5005931	
115,135	1973			REC318358
V4 CROSSFLOW				
85, 88, 90, 100, 110, 115	1978-94			REC318358
85, 88, 90, 110, 115	-1979		REC439085	
E90	2004	4	REC5005931	
100, 115, 140	1978-84		REC439085	
115	1985		REC439085	REC332819
115, 135, 140	1973-78		REC318358	REC318358
E115	2009		REC5007850	
135, 140	1973-84			REC332819
140	1977-84			REC318358
E130	2009		REC5007850	
V4 90° LOOPCHARGED				
120, 140	1985-87		REC396750	REC328623
120, 130, 140	1988-94		REC432570	REC340115
130	1995		REC432570	
V4 60° LOOPCHARGED				
90-115	-1995		REC439559	
90-115 FFI	-1998		REC5000400	
V6 90° CROSSFLOW				
2.6XP-GT	1983-85			REC332818
150	1978-91		REC391988	

		cyl	KIT	
150, 155, 175, 185, 200	1976-85			REC332817
E150	2006		REC5007129	
155	1986-91		REC391988	
175	1977-85		REC391988	
E175	2006		REC5007129	
185	1984-85		REC391988	
200	1976-83		REC391988	
E200	2006		REC5007129	
235	1978-79		REC391988	REC766779 REC332817
175	1986-91		REC434381	REC335361
235	1980-85		REC434381	REC335361 REC332818
V6 60° LOOPCHARGED				
150-175 V6 60°	-1991		REC437155	
V6 90° LOOPCHARGED				
200, 225	1985-87		REC398172	
200, 225	1986-87			REC331211
200, 225	1988-1993		REC436891	REC333670
200, 225, 250	1994-01		REC437725	REC345257
V8 LOOPCHARGED 4L				
250, 275, 300 Special	-1988		REC398693	
250, 275, 300	1988-93			REC340116
300	1993-94			REC340116

JUNTAS BASE DE MOTOR

CYLINDER GASKET

GUARNIZIONE
BASE MOTORE

JOINTS DE TETE MOTRICE

REF	OEM	
REC324717	324717	9.9 - 15 HP (1972-85)



REF	OEM	
REC325721	325721	9.9 - 15 HP (1986+)

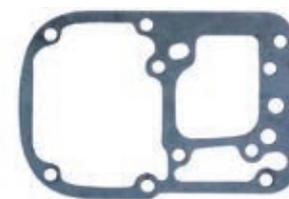

REF	OEM	
REC319710	319710	25, 35 HP (1976-78)

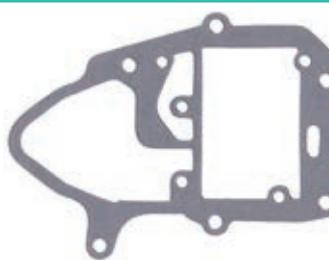

REF	OEM	
REC0330621	330621	25, 35 HP (1979+)

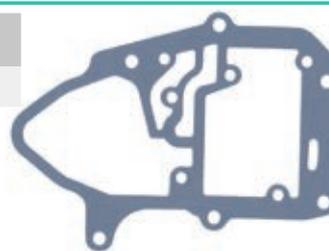

REF	OEM	
REC319348	319348	28, 33, 40 HP



REF	OEM	
REC351018	351018	2 Cyl Loopcharged

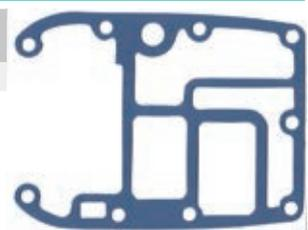

REF	OEM	
REC313763	313763	3 cyl Junta fina Thin gasket guarnizione fina joint fine
REC328618	328618	3 cyl Junta gruesa Thick gasket guarnizione gorda joint grosse



REF	OEM	
REC329828	329828	3 cyl, 60, 70 HP

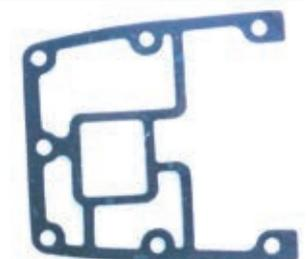

REF	OEM	
REC318373	318373	90° V4 Crossflow (1973-77)

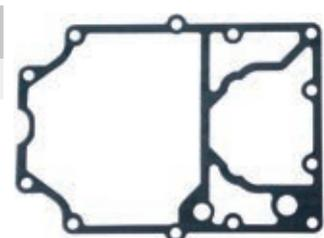

REF	OEM	
REC342513	342513	90° V4 Crossflow (1978-97)

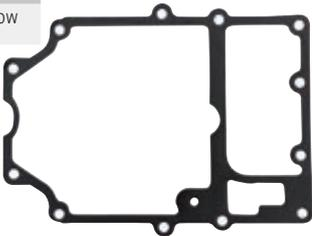

REF	OEM	
REC323214	323214	90° V6 Crossflow

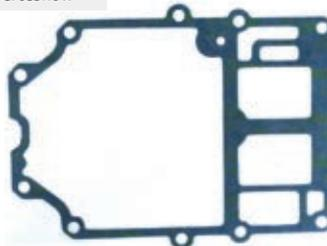

REF	OEM	
REC328590	328590	90° V4 Loopcharged

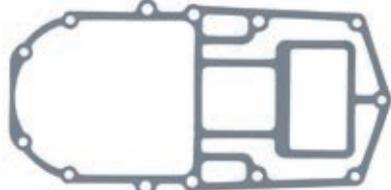

REF	OEM	
REC333879	333879	90° V6 Loopcharged

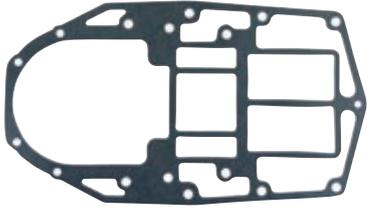

REF	OEM	
REC343853	343853	60° V4 (1997)

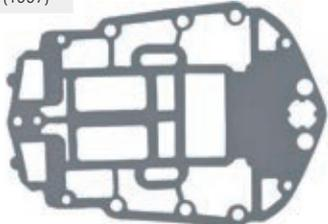

REF	OEM	
REC335419	335419	60° V6



REF	OEM	
REC344386	344386	60° V4 (1988+)

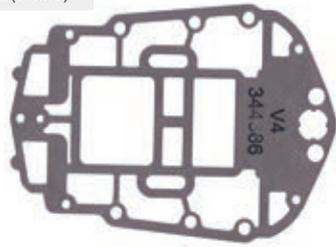

REF	OEM	
REC329975	329975	90° v8 Loopcharged

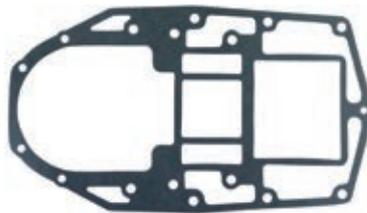

GUÍA CORREAS DE DISTRIBUCIÓN

GUIDE TIMING BELT

GUIDA CINGHIE DISTRIBUZIONE

GUIDE DES COURROIES DE DISTRIBUTION

		REF	OEM
J10/J15 HP	69	REC12761-93E0	5033070
J/JJ 60, 70 HP	89	REC12761-72F00	5030660



new

SISTEMA DE ESCAPE Y ADMISIÓN EXHAUST & INTAKE SYSTEM

SISTEMA DI SCARICO E ASPIRAZIONE SYSTEME D'ÉCHAPPEMENT ET D'ADMISSION

SISTEMA DE ESCAPE

EXHAUST SYSTEM

SISTEMA SCARICO

SYSTEME D'ÉCHAPPEMENT

JUNTAS ESCAPE

GASKETS, EXHAUST

GUARNIZIONE SCARICO

JOINT D'ÉCHAPPEMENT

REF	OEM	
REC802243	313065	5, 5.5, 6 HP

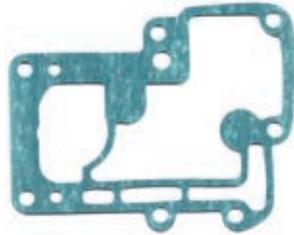

REF	OEM	
REC0326264	326264	2 Cyl Crossflow

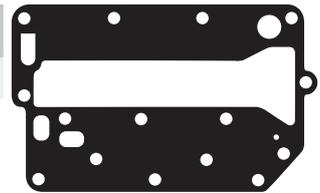

REF	OEM	
REC325211	325211	5, 5.5, 6 HP

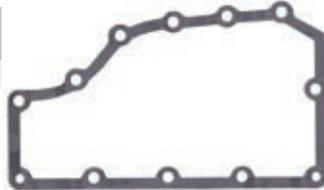

REF	OEM	
REC315868	315868	2 Cyl Loopcharged

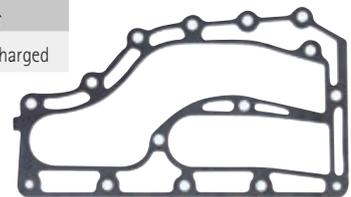

REF	OEM	
REC318925	318925	9.9, 15 HP



REF	OEM	
REC315869	315869	2 Cyl Loopcharged

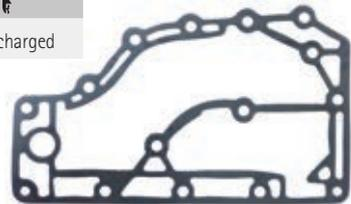

REF	OEM	
REC0324323	3234323	25, 35 HP

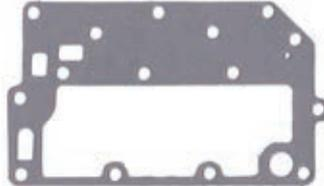

REF	OEM	
REC331916	331916	3 Cyl

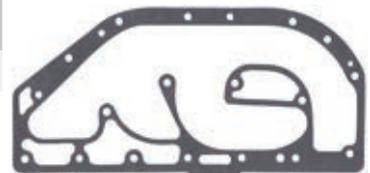

REF	OEM	
REC14212-93J00	5034982	J/BJ200 J/BJ225 (2004-06)

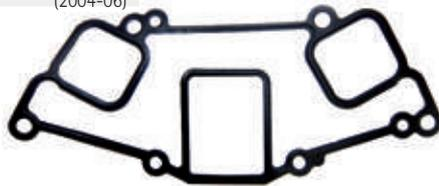

REF	OEM	
REC331917	331917	3 Cyl

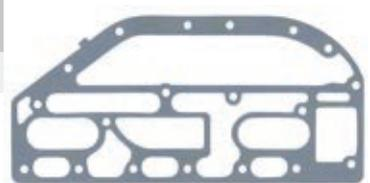

REF	OEM	
REC14152-93J00	5034979	J/BJ200 PORT
REC14151-93J00	5034978	J/BJ225 (2004-06) STB

REC14151-93J00



REC14152-93J00



REF	OEM	
REC343863	343863	3 Cyl 60 - 70 HP

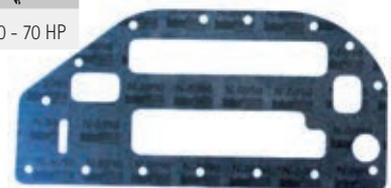

REF	OEM	
REC317955	317955	90° V4 Crossflow

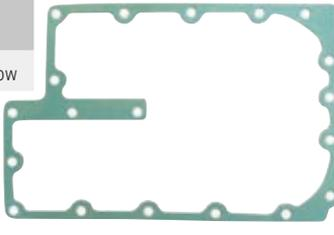

REF	OEM	
REC323469	323469	90° V4 Crossflow

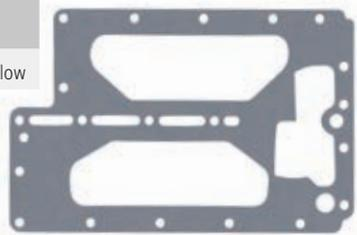

REF	OEM	
REC317914	317914	90° V4 Crossflow

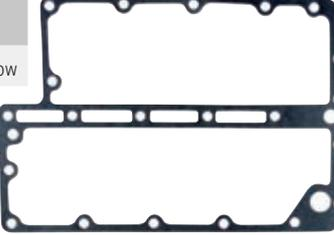

REF	OEM	
REC393561	393561	90° V6 Crossflow, 235 HP



REF	OEM	
REC305176	305176	90° V4 Crossflow

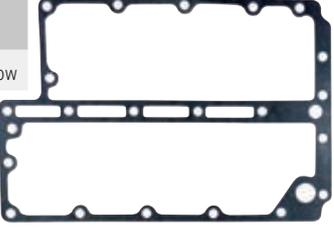

REF	OEM	
REC321182	321182	90° V6 Crossflow

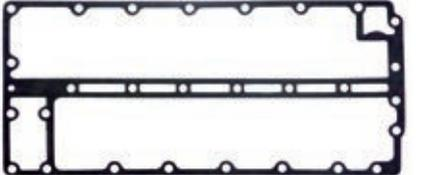

JUNTAS CUERPO DE ESCAPE INTERMEDIAS

INTERMEDIATE HOUSING EXHAUST GASKET

GUARNIZIONE SCARICO ED INTERMEDIE

JOINT D'ÉCHAPPEMENT DU CORPS INTERMÉDIAIRE

REF	OEM	
REC351019	351019	2 Cyl Loopcharged

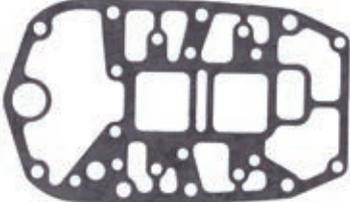

REF	OEM	
REC329826	329826	2 Cyl Loopcharged



REF	OEM	
REC336308	336308	3 Cyl, 60, 70, HP (1986+)



REF	OEM	
REC331016	331016	3 Cyl (1972-85)



RETENES CUERPO DE ESCAPE

SEALS - HOUSING EXHAUST

PARAOLIO SCARICO

JOINT DU COUVERCLE D'ÉCHAPPEMENT

REF	OEM	
REC320936	320936	V4 - V6



REF	OEM	
REC320961	320961	V4 - V6

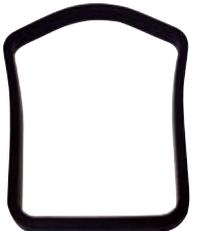

REF	OEM	
REC324937	324937	40 - 75 HP



4T
STROKES

JUNTAS DE CARTER

OIL PAN GASKET

GUARNIZIONE COPPA OLIO

JOINT DE CARTER D'HUILE

REF	OEM	
REC11489-90J00	5033649	J/BJ90 J/BJ115 J/BJ140 (2003-06)

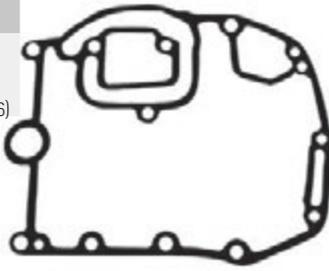

REF	OEM	
REC11489-93E11	5034462	J10 J15 (2004-07)



REF	OEM	
REC11489-87J00	5031307	J/BJ 40, 50HP

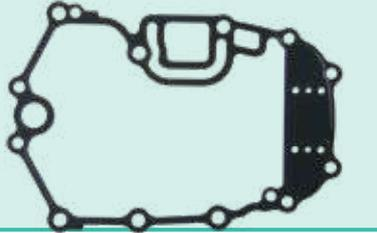

new

REF	OEM	
REC11489-93J00	5034878	J/BJ200 J/BJ225 (2004-06)

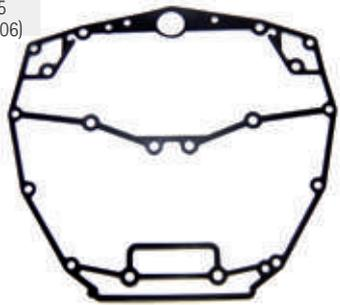

SISTEMA DE ADMISIÓN INTAKE SYSTEM

SISTEMA ASPIRAZIONE SYSTEME D'ADMISSION

JUNTAS TAPA PASO AGUA BLOQUE

POWERHEAD WATER PASSAGE COVER GASKETS

GUARNIZIONI COPERCHIO PASSAGGIO ACQUA

JOINTS DE COUVERCLE DU PASSAGE D'EAU

REF	OEM	
REC350357	342291	60° V4 / V6

Junta base regulador
Regulation mount gasket
Guarnizione base regolatore
Joint base régulateur



REF	OEM	
REC315538	315538	50, 55 HP

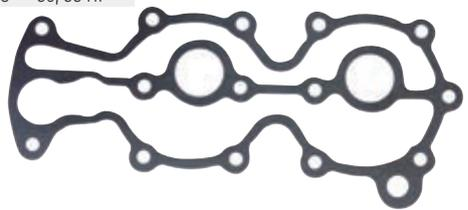

REF	OEM	
REC329920	329920	9.9, 15 HP

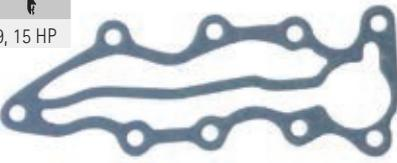

REF	OEM	
REC327674	327674	25, 35 HP



REF	OEM	
REC319665	319665	25, 35 HP



REF	OEM	
REC766871	318609	3 Cyl



REF	OEM	
REC318335	318335	V4



JUNTAS CUERPO PALOMILLA A COLECTOR **THROTTLE BODY TO MANIFOLD GASKETS** **GUARNIZIONI CORPO FARFALLA COLLETTORE** **JOINT CORPS DE PAPILLON POUR COLLECTEUR**

REF	OEM	
REC332319	332319	120 - 300 HP (1986+)



JUNTAS TAPA TRANSFERENCIA BAVOR MOTORES CROSSFLOW **CROSSFLOW ENGINE POWERHEAD TRANSFER PORT GASKET** **GUARNIZIONI COPERCHIO SINISTRO MOTORI CROSSFLOW** **JOINT DE COUVERCLE DE TRANSFERT POUR MOTEURS CROSSFLOW**

REF	OEM	
REC319332	319332	9.9, 15 HP

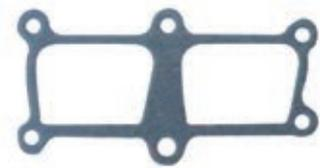

REF	OEM	
REC307133	307133	90° V4

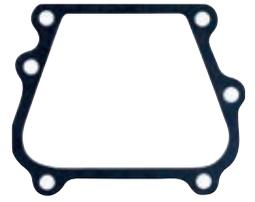

REF	OEM	
REC0319661	319661	25, 35 HP



JUNTAS DE CARBURADOR A COLECTOR ADMISION **CARBURETOR TO INTAKE MANIFOLD GASKETS** **GUARNIZIONI INTERMEDIA CARBURATORE - COLLETTORE ASPIRAZIONE** **JOINT DU CARBURATEUR AU COLLECTEUR D'ADMISSION**

REF	OEM	
REC325092	325092	20 - 75 (1980+)



REF	OEM	
REC318932	318932	6 - 30 (1975+)



REF	OEM	
REC327707	327707	V4 / V6



REF	OEM	
REC326926	326926	3 Cyl

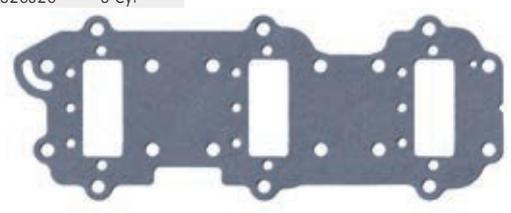

JUNTAS DE ADMISION BAVOR A CARBURADOR **PORT INTAKE TO CARBURETOR GASKETS** **GUARNIZIONI ASPIRAZIONE SINISTRA - CARBURATORE** **JOINT DU CARTER D'ADMISSION GAUCHE AU CARBURATEUR**

REF	OEM	
REC335818	335818	60° V4

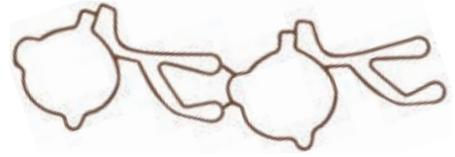

REF	OEM	
REC335403	335403	60° V6

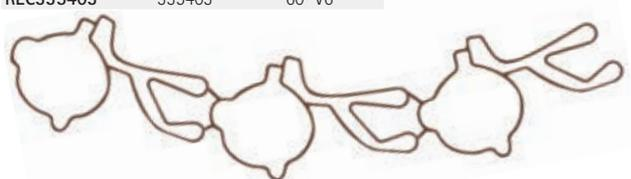

JUNTAS DE ADMISION ESTRIBOR A CARBURADOR **STB INTAKE TO CARBURETOR GASKETS** **GUARNIZIONI ASPIRAZIONE DISTRA - CARBURATORE** **JOINT DU CARTER D'ADMISSION DROIT AU CARBURATEUR**

REF	OEM	
REC335819	335819	60° V4

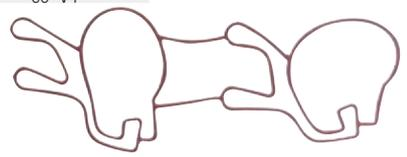

REF	OEM	
REC335404	335404	60° V6

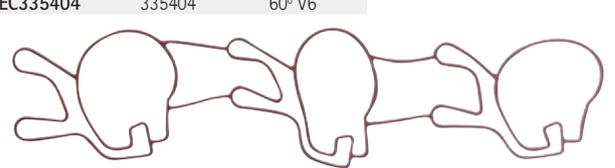

JUNTAS CAJA LENGÜETA REED BOX GASKETS GUARNIZIONE PIASTRA JOINT DE PLAQUE

REF	OEM	
REC332266	332266	90° V4, V6 Loopcharged



JUNTAS BASE LENGÜETA REED PLATE GASKETS GUARNIZIONE PIASTRA JOINT DE PLAQUE

REF	OEM	
REC318924	318924	9.9, 15 HP



REF	OEM	
REC325260	325260	9.9, 15 HP



REF	OEM	
REC0321479	321479	25, 35 HP



REF	OEM	
REC0326260	326260	25, 35 HP



JUNTAS COLECTOR GASKET, COLLECTOR GUARNIZIONE COLLETTORE JOINT DE COLLECTEUR

REF	OEM	
REC315578	315578	2 Cyl Loopcharged



REF	OEM	
REC319174	319174	90° V4



REF	OEM	
REC335633	335633	2 Cyl Loopcharged

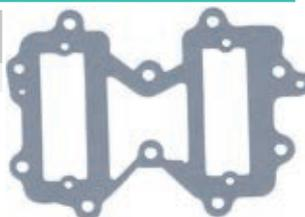

REF	OEM	
REC328622	328622	90° V4 / V6 Loopcharged

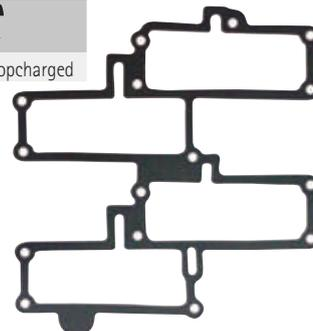

REF	OEM	
REC13122-95J00	5036852	J/BJ 25 (2006-07)



REF	OEM	
REC336388	336388	60° V4
REC336289	336389	60° V4

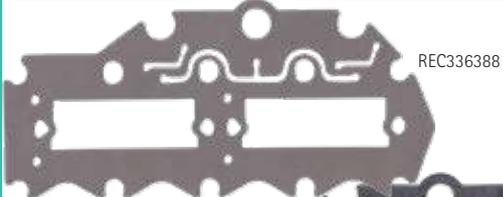

REC336388

REF	OEM	
REC13119-93J00	5034959	J/BJ 200 J/BJ 225 (2004-06)



REC336289



REF	OEM	
REC329718	329718	90° V6 Crossflow



REF	OEM	
REC336226	336226	60° V4 Babor Port Babordo Babord

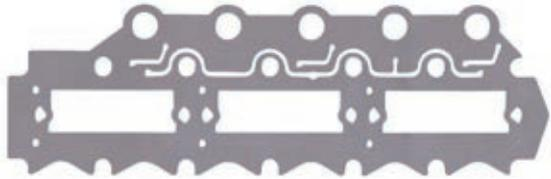

REF	OEM	
REC331532	331532	90° V6 Loopcharged

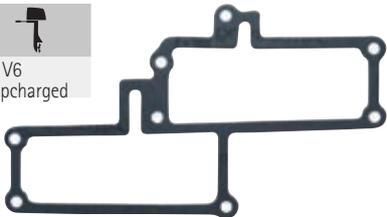

REF	OEM	
REC336227	336227	60° V6 Estribor STB Tribordo Tribord

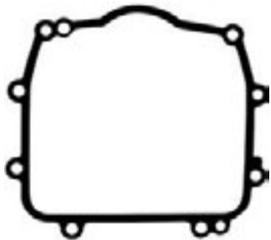

JUNTAS BASE RETÉN	GASKET, MOUNT OIL SEAL COVER	GUARNIZIONE, BASE PARAOLIO	JOINT DE COUVERCLE D'HUILE						
<table border="1"> <thead> <tr> <th>REF</th> <th>OEM</th> <th></th> </tr> </thead> <tbody> <tr> <td>REC51123-93J00</td> <td>5035133</td> <td>J/BJ 200 J/BJ 225 (2004-06)</td> </tr> </tbody> </table>	REF	OEM		REC51123-93J00	5035133	J/BJ 200 J/BJ 225 (2004-06)			
REF	OEM								
REC51123-93J00	5035133	J/BJ 200 J/BJ 225 (2004-06)							

JUNTAS, GUÍA CADENA	GASKET TIMING CHAIN GUIDE BASE	GUARNIZIONE CARTER CATENA	JOINT DU GUIDE DE DISTRIBUTION						
<table border="1"> <thead> <tr> <th>REF</th> <th>OEM</th> <th></th> </tr> </thead> <tbody> <tr> <td>REC12778-93J00</td> <td>5034916</td> <td>J/BJ 200 J/BJ 225 (2004-06)</td> </tr> </tbody> </table>	REF	OEM		REC12778-93J00	5034916	J/BJ 200 J/BJ 225 (2004-06)			
REF	OEM								
REC12778-93J00	5034916	J/BJ 200 J/BJ 225 (2004-06)							

JUNTAS BOMBA DE ACEITE	GASKET OIL PUMP GALLERY	GUARNIZIONE POMPA D'OLIO	JOINT POMPE D'HUILE												
<table border="1"> <thead> <tr> <th>REF</th> <th>OEM</th> <th></th> </tr> </thead> <tbody> <tr> <td>REC16433-93J00</td> <td>5035022</td> <td>J200 / BJ200 4225 / BJ225 (2004-06)</td> </tr> </tbody> </table>	REF	OEM		REC16433-93J00	5035022	J200 / BJ200 4225 / BJ225 (2004-06)		<table border="1"> <thead> <tr> <th>REF</th> <th>OEM</th> <th></th> </tr> </thead> <tbody> <tr> <td>REC17693-95J00</td> <td>5036914</td> <td>J/BJ 25 (2006-07)</td> </tr> </tbody> </table>	REF	OEM		REC17693-95J00	5036914	J/BJ 25 (2006-07)	
REF	OEM														
REC16433-93J00	5035022	J200 / BJ200 4225 / BJ225 (2004-06)													
REF	OEM														
REC17693-95J00	5036914	J/BJ 25 (2006-07)													

JUNTAS SILENCIADOR

AIR SILENCER GALLERY

GUARNIZIONE MARMITA

JOINT DU SILENCIEU

REF	OEM	
REC338882	338882	5 - 35 HP



REF	OEM	
REC314115	314115	70, 75 HP



REF	OEM	
REC323338	323338	25, 35 HP



REF	OEM	
REC386573	386573 319771	85 - 140 HP



REF	OEM	
REC330689	330698	35 - 55 HP

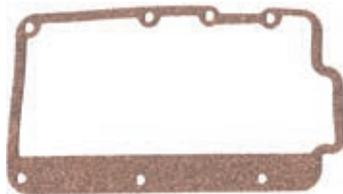

REF	OEM	
REC333008	333008	3 Cyl



REF	OEM	
REC330909	330909	35 - 55 HP

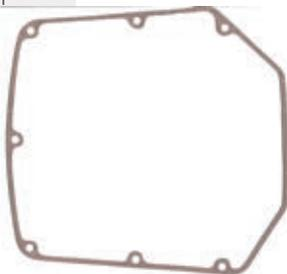

REF	OEM	
REC321794	3214794	3 Cyl

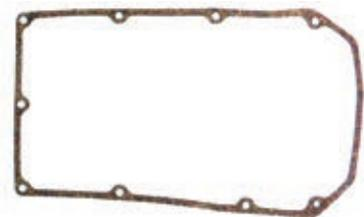

REF	OEM	
REC321497	321497	40 - 60 HP



REF	OEM	
REC321722	3214722	V4

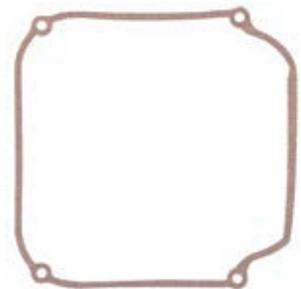

REF	OEM	
REC320679	320679	40 - 60 HP

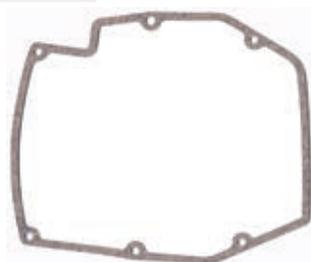

RETENES DE ACEITE

OIL SEALS

PARAOLIO

JOINT SPI

RETÉN DE ACEITE

OIL SEAL

PARAOLIO

JOINT SPI

REF	OEM		
REC09282-10008	5030107	E5 / J5 J4 / J6 (1998-07)	

REF	OEM		
REC09282-12008	5030108	E5 / J5 J4 / J6 (1998-07)	

REF	OEM		
REC09282-12010	5033011	J10 J15 (2002-07)	

REF	OEM		
REC09282-17009	5031266	E25 / J 25 E40 / J40 E50 / J50 E30 / J50 (1999-07)	

REF	OEM		
REC09282-15008	5036938	J/BJ25 (2006-07)	

REF	OEM		
REC09283-20018	5030110	E5 / J5 (1998-01)	

REF	OEM		
REC09282-17005	5031264	E40 / J40 / BJ40 E50 / J50 / BJ50 (1999-06)	

REF	OEM		
REC09283-20045	5030111	E5 / J5 (1998-01)	

REF	OEM		
REC09283-10003	5030109	E5 / J5 (1998-01)	

REF	OEM		
REC09283-25076	5033481	J4 / J5 / J5 (2003-06)	

REF	OEM		
REC09283-10009	5033339	J4 / J5 / J6 (2003-07)	

REF	OEM		
REC09289-17006	5033015	J10 J15 (2002-07)	

REF	OEM		
REC09289-20009	5031893	E25 / J25 / BJ25 E30 / J30 / BJ30 (2000-07)	

REF	OEM		
REC09289-22007	5031270	E40 / J40 / BJ40 E50 / J50 / BJ50 (1999-06)	

JUNTA TAPÓN DE DRENAJE

O-RING DRAIN CAP

GUARNIZIONE TAPPO DRENAGGIO

JOINT DE VIDANGE

REF	OEM		
REC09168-10022	5030071	4 - 140 HP	10 x 17 x 1.5 mm

new

UNIDADES DE TRANSMISIÓN UNIT DRIVES & COMPONENTS

UNITÀ DI TRASMISSIONE EMBASES ET PIÈCES

COLA

GEARCASE ASSY

PIEDI

EMBASE

2 & 3 CYL. LOOPCHARGED

Cola pequeña estilo "antiguo"
(1975-88)
Altura: 15-1/2".
Final de la aleta de cavitación afilado.
Seis agujeros sobre la aleta de cavitación. Tomas internas de agua (cuatro agujeros). Sin tubo corredera.

Small Gearcase "Old" Style
(1975-88)
15-1/2" tall.
Pointed at the trailing end of the cavitation plate. Six holes above the cavitation plate. Internal water intake screens (four holes). No speedo pitot.

Piede vecchia generazione
(1975-88)
Altezza:15-1/2".
Terminale pinna di cavitazione sottile.
Sei fori nella pinna, e prese d'acqua a 4 fori.
Senza tubo scorrevole.

Petite embase ancienne génération
(1975-88)
Hauteur : 15-1 / 2".
Fin d'aileron de cavitation pointu. Six trous sur l'aileron de cavitation. Prises d'eau internes (quatre trous). Sans tube coulissant

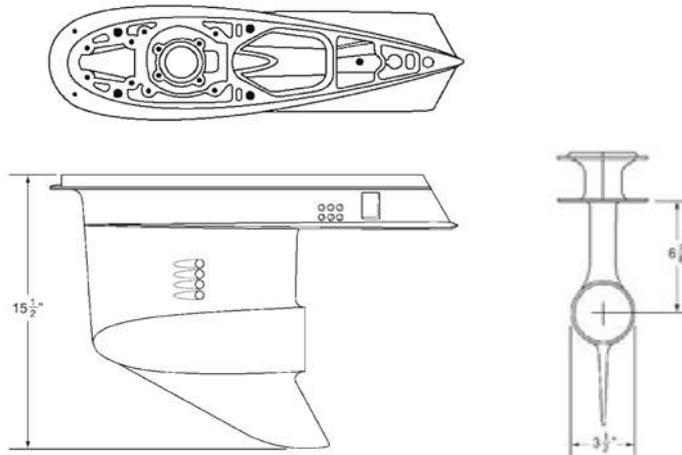

Cola pequeña estilo "moderno"
(1989-05)
Altura: 15-3/5".
Final de la aleta de cavitación afilado.
Seis agujeros sobre la aleta de cavitación.
Tomas externas de agua.
Con tubo corredera.

Small Gearcase "New" Style
(1989-05)
15-3/2" tall.
Pointed at the trailing end of the cavitation plate.
Six holes above the cavitation plate.
External water intake screens.
Includes speedo pitot.

Piede moderna generazione
(1989-05)
Altezza:15-3/5".
Terminale pinna di cavitazione sottile.
Sei fori nella pinna, e prese d'acqua a 4 fori.
Senza tubo scorrevole.

Petite queue de style "moderne"
(1989-05)
Hauteur : 15-3 / 5".
Fin d'aileron de cavitation conique.
Six trous sur l'aileron de cavitation.
Prises d'eau extérieures.
Avec tube de speedo

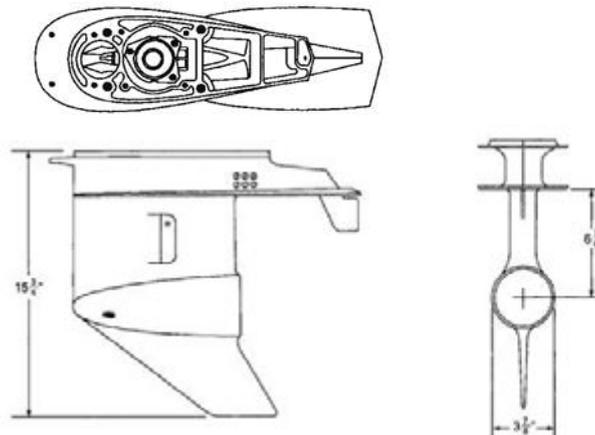

Cola larga (1975-06)
 Altura: 17-7/16"
 Final de la aleta de cavitación afilado
 Seis agujeros sobre la aleta de cavitación
 Tomas internas de agua (tres agujeros)
 Sin tubo corredera

Large Gearcase (1975-06)
 17-7/16" tall.
 Pointed at the trailing end of the cavitation plate.
 Six holes above the cavitation plate.
 Internal water intake screens (three holes).
 No speedo pitot.

Piede lungo (1975-06)
 Altezza: 17-7/16".
 Terminale pinna di cavitazione sottile.
 Sei fori nella pinna, e prese d'acqua a 4 fori.
 Senza tubo scorrevole.

Embase longue (1975-06)
 Hauteur : 17-7/16".
 Fin d'aileron de cavitation conique
 Six trous sur l'aileron de cavitation
 Prises d'eau internes (trois trous)
 Sans tube speedo

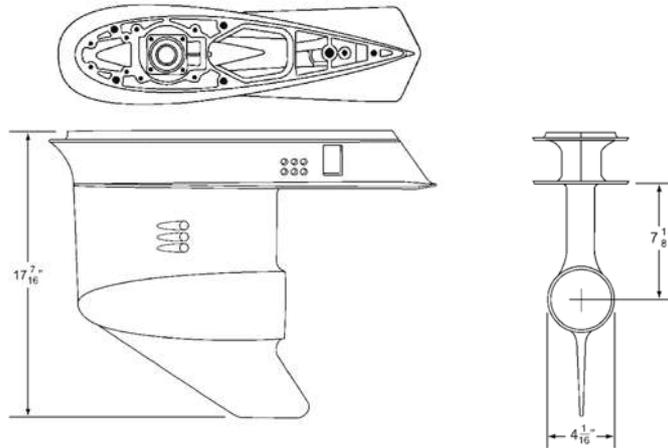

V4 90°

Cola pequeña (1978-98)
 Altura: 18-3/16"
 Final de la aleta de cavitación afilado
 Seis agujeros sobre la aleta de cavitación
 Tomas internas de agua (cuatro agujeros)
 Sin tubo corredera

Small Gearcase (1978-98)
 18-3/16" tall.
 Pointed at the trailing end of the cavitation plate.
 Six holes above the cavitation plate.
 Internal water intake screens (four holes).
 No pitot.

Piede vecchia (1978-98)
 Altezza: 18-3/16".
 Terminale pinna di cavitazione sottile.
 Sei fori nella pinna, e prese d'acqua a 4 fori.
 Senza tubo scorrevole.

Petite embase (1978-98)
 Hauteur : 18-3/16".
 Fin d'aileron de cavitation conique
 Six trous sur l'aileron de cavitation
 Prises d'eau internes (quatre trous)
 Sans tube de speedo

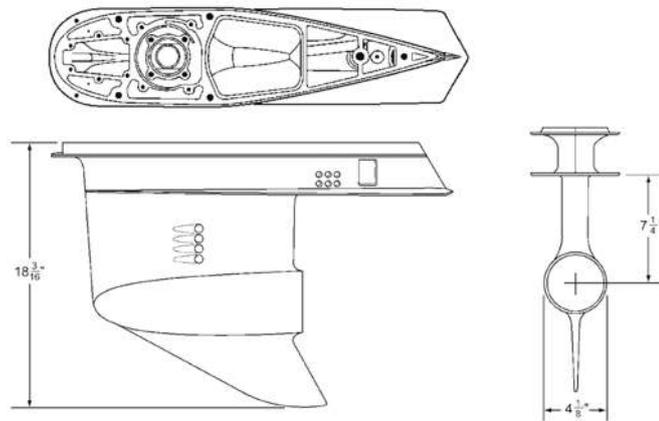

V4 60°

Cola pequeña (1995-06)
 Altura: 19-1/16"
 Final de la aleta de cavitación plano
 Dos ranuras sobre la aleta de cavitación
 Tomas externas de agua.

Small Gearcase (1995-06)
 19-1/16" tall.
 Flat at the trailing end of the cavitation plate.
 Two slots above the cavitation plate.
 External water intake screens.

Piede vecchia (1995-06)
 Altezza: 19-1/16".
 Terminale pinna di cavitazione piano.
 Due fessure sopra la pinna di cavitazione.
 Prese d'acqua esterne.

Petite embase (1995-06)
 Hauteur : 19-1/16".
 Finition d'aileron à cavitation plate
 Deux rainures sur l'aileron de cavitation
 Prises d'eau extérieures

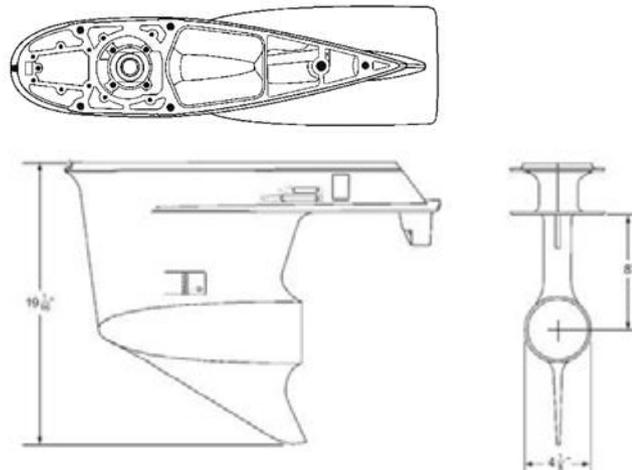

V4 / V6

Cola larga "O" (1979-06)
 Altura: 19-3/16"
 Final de la aleta de cavitación afilado
 Dos ranuras sobre la aleta de cavitación
 Tomas externas de agua

Large Gearcase "O" type (1979-06)
 19-3/16" tall.
 Pointed at the trailing end of the cavitation plate.
 Two slots above the cavitation plate.
 External water intake screens.

Piede lungo "O" (1979-06)
 Altezza: 19-3/6"
 Terminale pinna di cavitazione sottile.
 Due fessure sopra la pinna di cavitazione.
 Prese d'acqua esterne.

Embase longue "O" (1979-06)
 Hauteur : 19-3/16"
 Fin d'aileron de cavitation conique
 Deux rainures sur l'aileron de cavitation
 Prises d'eau extérieures

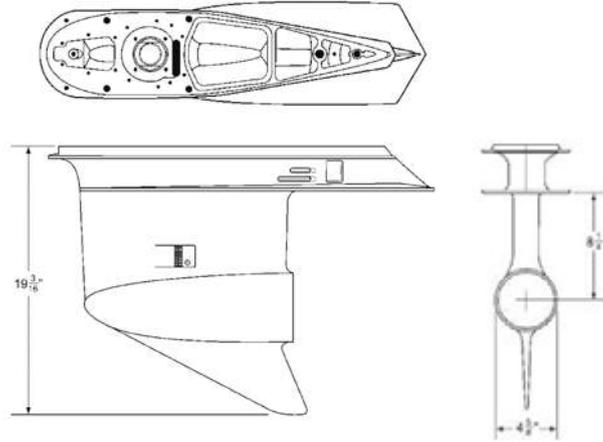

Cola larga "M" (2002-06)
 Altura: 19-3/16"
 Final de la aleta de cavitación plano
 Tres ranuras sobre la aleta de cavitación
 Tomas externas de agua
 Con tubo corredera

Large Gearcase "M" type (2002-06)
 19-3/16" tall.
 Flat at the trailing end of the cavitation plate.
 Three slots above the cavitation plate.
 External water intake screens.
 Includes speedo pitot.

Piede lungo "M" (2002-06)
 Altezza: 19-3/6"
 Terminale pinna di cavitazione sottile.
 Due fessure sopra la pinna di cavitazione.
 Prese d'acqua esterne.
 Con tubo scorrevole.

Embase longue "M" (2002-06)
 Hauteur : 19-3/16"
 Finition d'aileron à cavitation plate
 Trois rainures sur l'aileron de cavitation
 Prises d'eau extérieures
 Avec tube de speedo

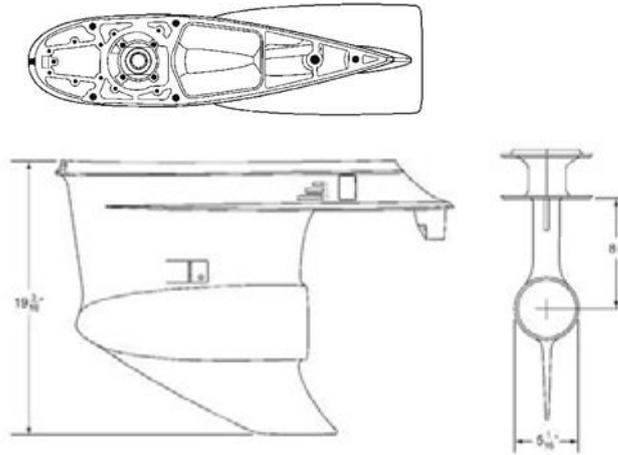

COLA COMPLETA

GEARCASE ASSY

PIEDE COMPLETO

EMBASE COMPLÈTE

REF	OEM	
REC0435279	435279 1993+	20" 40, 48, 50 HP



CARCASA **EMPTY GEARCASE** **CARCASSA** **CARTER**

REF	OEM	REDUCCIÓN GEAR RATIO RIDUZIONE REDUCTION	
REC5007022	439972 438048	2.25:1 (.44), 12:27	V4 (1978-06) Crossflow (1983-96) 60° Loopcharged (1995-98) 90° Loopcharged (1985-98) V6 (1978-06)
		1.83:1 (.55), 12:22 Heavy Duty	Crossflow (1979-92) 60° Loopcharged (1991-05) 90° Loopcharged (1986-05)



Sin tubo corredera
Without speedo.
Senza tubo scorrevole.
Sans tube de speedo

REF	OEM	REDUCCIÓN GEAR RATIO RIDUZIONE REDUCTION	
REC439973	439973	1.83:1 (.55), 12:22 Heavy Duty	V6 (1978-06) Crossflow (1979-92) 60° Loopcharged (1991-01) 90° Loopcharged (1986-01)



Con tubo corredera
With speedo.
Con tubo scorrevole.
Avec tube de speedo

GUÍA DE COLAS **GEARCASE GUIDE** **GUIDA PIEDE** **GUIDE D'EMBASES**

		COMPLETA ASSY COMPLETE	CARCASA GEARCASE EMPTY CARCASSA CARTER			COMPLETA ASSY COMPLETE	CARCASA GEARCASE EMPTY CARCASSA CARTER
40 15"	93	REC0435279		V4 60° Loopcharged 25"	1995-06		REC5007022
48 15"	93	REC0435279		V6 60° Loopcharged 20" w/ External Screens	1995-00		REC5007022
50 15"	93	REC0435279		V6 60° Loopcharged 25" w/ External Screens	1991-99		REC5007022
100 WPL 20"	1999		REC5007022	V6 60° Loopcharged 25" C/R	1992-99		REC5007022
100 WPX 25"	1999		REC5007022	150 Comm. 20"	1993-99		REC5007022
100 Comm. 20" Large	1988-97		REC5007022	150 Comm. 25"	1993-99		REC5007022
100 Comm. 25" Large	1988-97		REC5007022	155 Comm. 20"	1988-92		REC5007022
100 WQX, 105 WEX 25"	1998		REC5007022	155 Comm. 25"	1988-92		REC5007022
105 Comm. WPL 20"	2000-01		REC5007022	V6 Crossflow 20" Et 90° Loopcharged	88-91		REC439973
105 Comm. WPX 25"	2000-01		REC5007022	V6 Crossflow 25" Et 90° Loopcharged	88-91		REC439973
105 Comm. WEL 20"	2000-01		REC5007022	V6 Crossflow 20" Et 90° Loop- charged C/R	88-91		REC439973
105 WEL 20"	1998		REC5007022	V6 90° Loopcharged 20" w/ Internal Screens	92-99		REC439973
105 WRL 20"	1997-98		REC5007022	V6 90° Loopcharged 20" w/ External Screens	92-99		REC5007022
105 WRX 25"	1997-98		REC5007022	V6 90° Loopcharged 25"	92-99		REC5007022
105 RWL 20"	1998		REC5007022	V6 90° Loopcharged 25" C/R	92-99		REC5007022
105 RWY 22.5"	1998		REC5007022	V6 90° Loopcharged 30"	93-99		REC5007022
105 RWX 25"	1998		REC5007022	V6 90° Loopcharged 30" C/R	93-99		REC5007022
115 FPX/FX 25"	2000-01		REC5007022	200 Comm. 20"	93-99		REC5007022
125 RWL 20"	1995-97		REC5007022	200 Comm. 25"	93-99		REC5007022
125 RWY 22.5"	1995-98		REC5007022				
125 WTPL 20"	1992-98		REC5007022				
125 WTPX 25"	1988-98		REC5007022				
130 20"	1995-98		REC5007022				
130 25"	1995-98		REC5007022				
130 25" C/R	1995-97		REC5007022				
135 FPL/FL 20"	2000-01		REC439973				
135 FSL/FS 20"	2000-01		REC5007022				
135 FPX/FX 25"	2000-01		REC5007022				
140 25"	1988-94		REC5007022				
140 25" C/R	1988-94		REC439973				

HERRAMIENTAS

TOOLS

ATTREZZI

OUTILS

EXTRACTOR COJINETES Y
HÉLICES

PROP AND BEARING
PULLER

ESTRATTORE CUSCINETTI E
ELICHE

EXTRACTEUR DE ROUEMENTS
D'HELICE

REF

REC90095

RECMAR



Para hélices y cojinetes antiguos
For prop and old style bearing carrier.
Per eliche e cuscinetti vecchi.
Pour hélices et roulements anciens

Para cojinetes modernos
For new style bearing carrier.
Per cuscinetti moderni.
Pour roulements récents.

EXTRACTOR COJINETES

BEARING PULLER

ESTRATTORE CUSCINETTI

EXTRACTEUR DE ROUEMENTS

REF

REC91-34569A1

RECMAR



Para utilizar con las herramientas
REC91-43579 y REC91-36569T para
instalar y desmontar el cojinete

Used with REC91-43579 & REC91-36569T
tools to install & remove pinion bearing.

Da utilizzare con gli strumenti REC91-
43579 e REC91-36569T per installare e
smontare il cuscinetto.

A utiliser avec les outils REC91-43579
et REC91-36569T pour installer et retirer
le roulement

REF

REC91-31229



RECMAR

EXTRACTOR PIÑONES Y
COJINETES

UNIVERSAL PULLER PLATE

ESTRATTORE PIGNONE E
CUSCINETTI

EXTRACTEUR PIGNONS ET
ROUEMENTS

REF

PIÑONES
BEARINGS
PIGNONE
PIGNONS

REC91-00001 30-50 mm / 1^{1/4}" - 2^{1/4}"

REC91-00002 50-75 mm / 2^{1/4}" - 3^{1/2}"

REC91-37241 75-105 mm / 3" - 4^{1/2}"

RECMAR



KIT HERRAMIENTAS PARA
COLAS

GEAR CASE TOOL KIT

KIT ATTEZZI PIEDI

KIT OUTILS POUR EMBASES

REF

RM91-31229A7

RECMAR

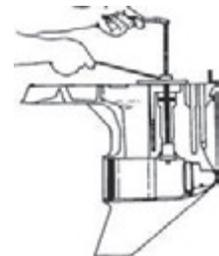

LLAVE TUERCA DIÁBOLO

BEARING CARRIER
RETAINER WRENCH

CHIAVE PER CUSCINETTO

CLE POUR ECROU DE
DIABOLO

REF

REC91-61069T

RECMAR

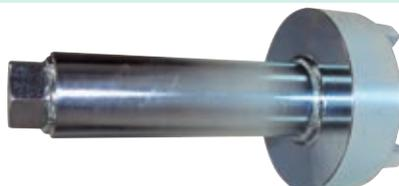

KIT LLAVE HÉLICE

PROP WRENCH KIT

KIT CHIAVE ELICA

CLE POUR ECROU D'HELICE

REF



REC91-859046Q4 1 1/16" 75 - 300 HP



RECMAR

FLOTANTE | FLOATING | GALLEGGIANTE | FLOTTANTE

REF



REC91-859046Q3 15/16" 30, 40, 50 Et 60 HP

RECMAR



new

LLAVE TUERCA EJE VERTICAL

PINION NUT ADAPTOR KIT

CHIAVE DADO ASSE VERTICALE

CLE POUR ARBRE VERTICAL

Incluye un adaptador eje. Sostiene la tuerca del piñón cuando se está sacando el piñón y el eje en las colas.

Holds pinion nut when removing pinion gear and drive shaft on drive units. Comes with drive shaft adaptor.

Incluye un adattatore albero. Tenendo il dado del pignone quando si rimuove la ruota dentata e l'albero nel piede.

Inclus un adaptateur d'arbre. Maintient l'écrou du pignon lors de la dépose du pignon et de l'axe sur les embases.

REF

RECMAR

REC91-61067A04



HERRAMIENTAS VOLANTE MOTOR

FLYWHEEL PULLER

ESTRATTORE VOLANO

EXTRACTEUR DE VOLANT MOTEUR

REF



2T STROKES 4T STROKES

REC90890-06820 40, 45, 50, 60HP (4 CYL) 75, 90, 115 (-1B366822) ✓



RECMAR

REF



2T STROKES 4T STROKES

REC91-895343T02 75-115HP (1B366823+) VERADO 135 - 300HP 150EFI ✓



RECMAR

- 1 Adaptador universal de elevación para motores
- 2 Extractor de volante
- 3 Se adapta directamente en volantes Yamaha y Mercury que no contienen anillos de elevación integrados. (Se suministra con tornillos)
- 4

- Universal lift adapter for motors
- Flywheel puller
- Fits directly on Yamaha and Mercury flywheels that do not contain integrated lift rings. (Supplied with screws)
-

- Adattatore di sollevamento universale per motori
- Estrattore volano
- Si adatta direttamente ai volani Yamaha e Mercury che non contengono anelli di sollevamento integrati. (Fornito con viti)
-

- Adaptateur de levage universel pour moteurs
- Extracteur de volant
- S'adapte directement sur les volants d'inertie Yamaha et Mercury qui ne contiennent pas d'anneaux de levage intégrés. (Fourni avec des vis)
-



1.5"

DESPIECE COLAS
4 TIEMPOS

GEAR CASE PARTS
4 STROKES

PARTI PIEDI
DE 4 TEMPI

PIECES D'EMBASES
4 TEMPS

4T J4, J5, J6 HP
STROKES

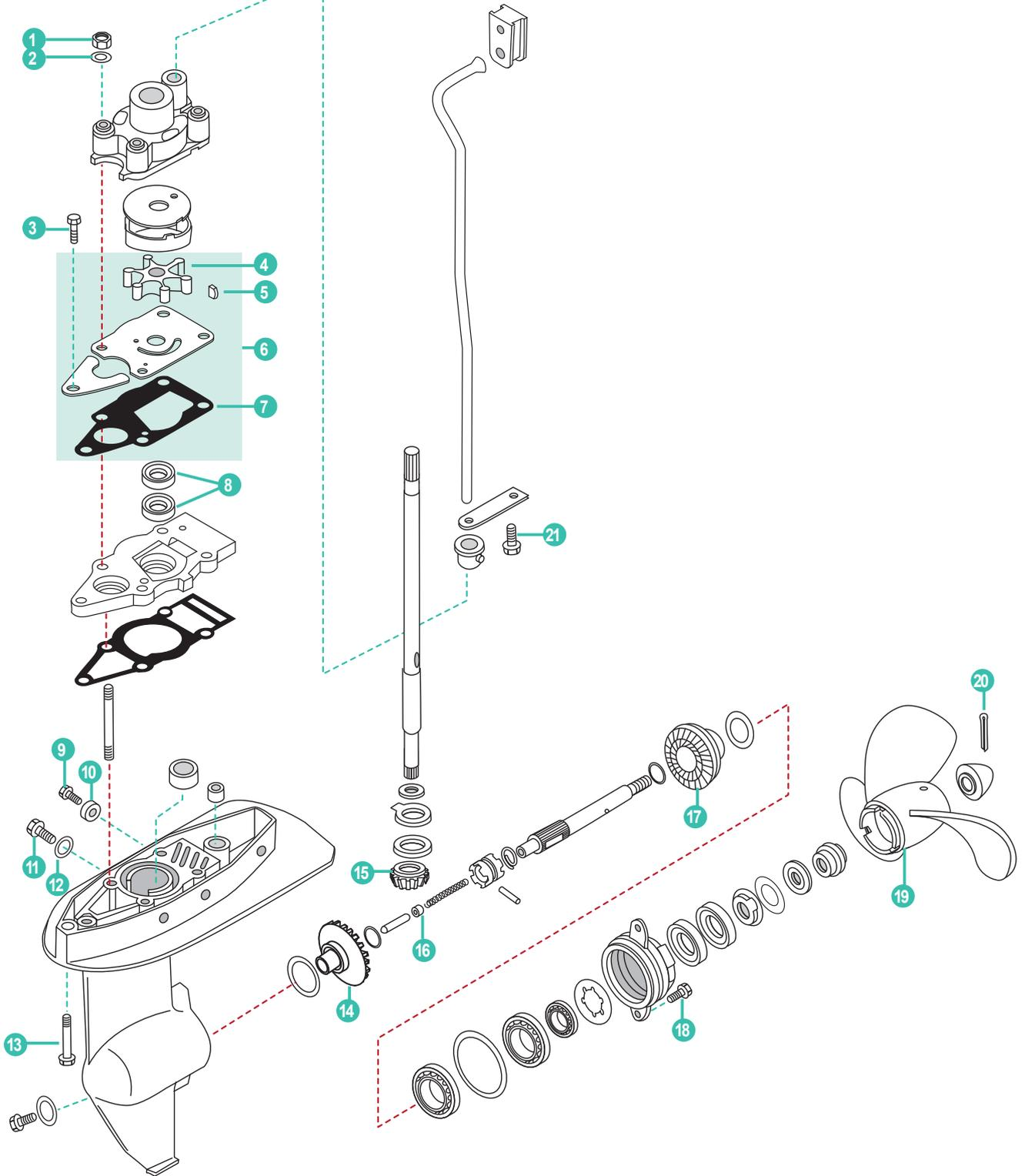

	REF	OEM				
1	PAGB/T6170-M6	5030051	TUERCA HEXÁGONO M6	NUT HEXAGON M6	DADO ESAGONALE M6	ECROU HEXAGONAL M6
2	PAGB/T848-6	530429	ARANDELA	WASHER	RONDELLA	RONDELLE
3	PAGB/T5283-M6X25	5030391	TORNILLO HEXAGONAL M6x25	HEXAGON BOLT M6x25	BULLONE ESAGONALE M6x25	BOULON HEXAGONAL M6x25
4	REC17461-98503	5030188	IMPULSOR	IMPELLER	GIRANTE	TURBINE
5	REC09420-03002	5030137	CHAVETA IMPELLER	KEY	CHIUSURA	CLAVETTE TURBINE
6	REC17400-98661	5034323	KIT BOMBA AGUA	WATER PUMP KIT	KIT POMPA ACQUA	KIT POMPE À EAU
7	REC17472-91J00	5033381	JUNTA DE LA BOMBA	GASKET PUMPCASE	GUARNIZIONE POMPA	JOINT DE POMPE
8	REC09282-10008	5030107	RETÉN ACEITE	OIL SEAL	PARAOLIO	JOINT SPI
9	PAGB/T5783-M6X14	5036691	TORNILLO HEXAGONAL M6x14	HEXAGON BOLT M6x14	BULLONE ESAGONALE M6x14	BOULON HEXAGONAL M6x14
10	REC55321-87J01AL	5031705	ÁNODO	ANODE	ANODO	ANODE
11	REC09248-10008	5030094	TORNILLO 10x7,5	SCREW 10x7,5	VITE 10x7,5	VIS 10x7,5
12	REC09168-10022	5030071	ARANDELA TAPÓN	CAP, O-RING	RONDELLA TAPPO	JOINT DE VIDANGE
13	PAGB/T5787-1986	5031822	TORNILLO HEXAGONAL M8x50	HEXAGON BOLT M8x50	BULLONE ESAGONALE M8x50	BOULON HEXAGONAL M8x50
14	REC57510-91J00	5034203	PIÑÓN MARCHA AVANTE	FORWARD GEAR	INGRANAGGIO MARCIA AVANTI	PIGNON MARCHE AV
15	REC57311-98600	5030276	PIÑÓN ATAQUE	INITIATIVE GEAR	PIGNONE	PIGNON D'ATTAQUE
16	REC57632-97L00	5030282	PIN SELECTOR	SELECTOR PIN	PIN SELETTORE	CLAVETTE
17	REC57521-91J00	5030278	PIÑÓN MARCHA ATRÁS	RESERVE GEAR	PIGNONE MARCIA INDIETRO	PIGNON MARCHE AR
18	PAGB/T5783-M6X16	5030035	TORNILLO HEXAGONAL M6x16	HEXAGON BOLT M6x16	BULLONE ESAGONALE M6x16	BOULON HEXAGONAL M6x16
19	SOL4011-079-07S	5034345	HELICE AMITA 3 7.9x6.75	PROPELLER AMITA 3 7.9x6.75	ELICA AMITA 3 7.9x6.75	HELICE AMITA 3 7.9x6.75
20	REC91490-30025	5030087	PASADOR	PIN	FERMO	GOUPILLE
21	PAGB/T5783-M6X16	5030035	TORNILLO HEXAGONAL M6x16	HEXAGON BOLT M6x16	BULLONE ESAGONALE M6x16	BOULON HEXAGONAL M6x16



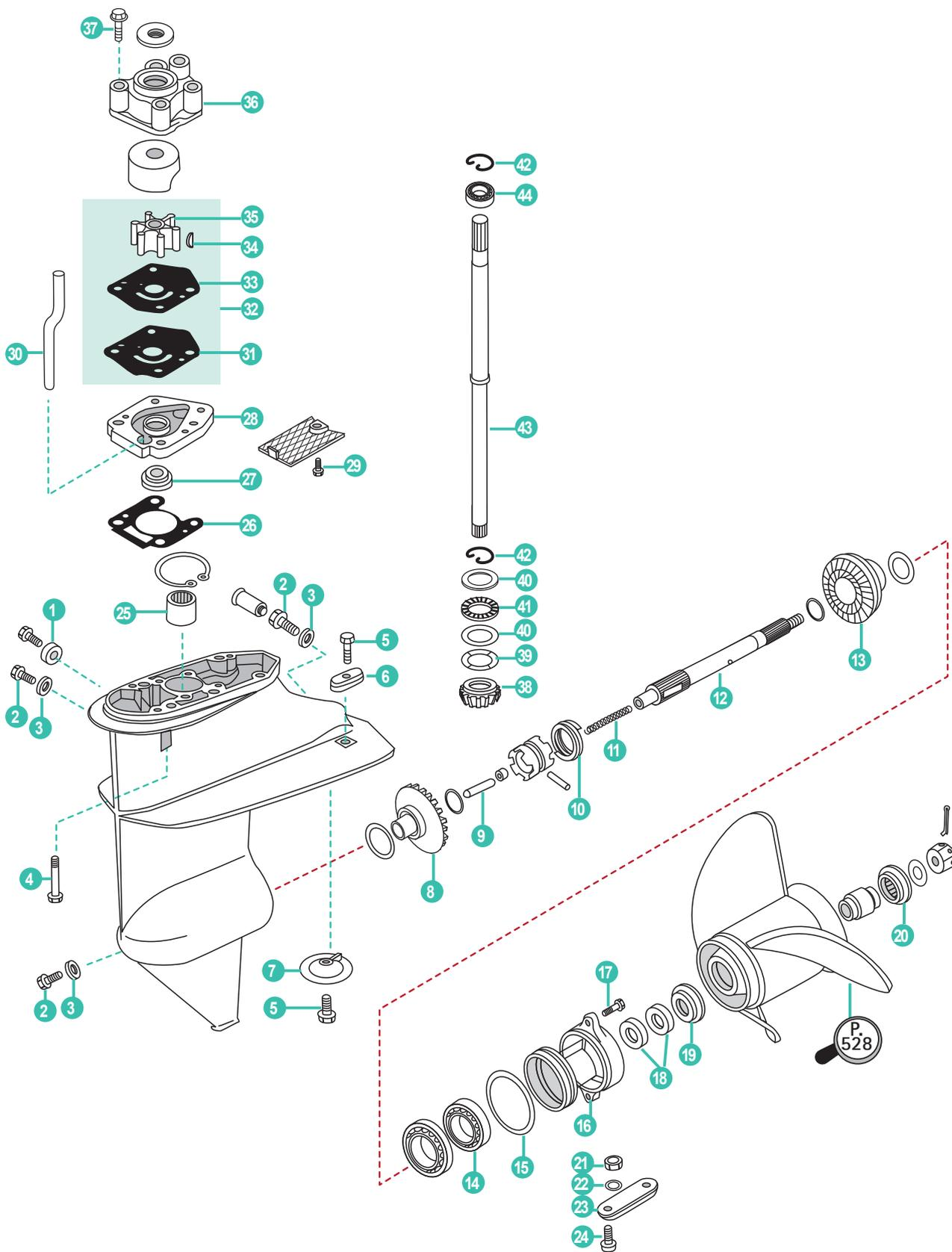

	REF	OEM				
1	CM55321-87J00	5031705	ÁNODO	ANODE	ANODO	ANODE
2	REC09248-10008	5030094	TORNILLO 10x7,5	SCREW 10x7,5	VITE 10x7,5	VIS 10x7,5
3	REC09168-10022	5030071	ARANDELA TAPÓN	CAP, O-RING	RONDELLA TAPPO	JOINT DE VIDANGE
4	PAGB/T5783-M8X30	5031216	TORNILLO M8X30	BOLT M8X30	BULLONE M8X30	BOULON M8X30
5	REC09116-06094	5030034	TORNILLO 6x15	SCREW 6x15	VITE 6x15	VIS 6x15
6	REC55320-98400AL	5033167	ÁNODO	ANODE	ANODO	ANODE
7	REC55321-93900	5033185	ÁNODO	ANODE	ANODO	ANODE
8	REC57510-93910	5033191	PIÑÓN MARCHA AVANTE	FORWARD GEAR	INGRANAGGIO MARCIA AVANTI	PIGNON MARCHE AVANT
9	REC57631-93901	5033196	VARILLA SELECTOR	ROD PUSH	ASTA SELETTORE	CLAVETTE
10	REC09440-32008	5033037	MUELLE	CLUTCH	MOLLA	RESSORT
11	REC09440-05027	5033034	MUELLE SELECTOR	SELECTOR SPRING	MOLLA SELETTORE	RESSORT DE SELECTEUR
12	REC57610-93901	5033193	EJE HELICE	PROPELLER SHAFT	ASSE ELICA	ARBRE D'HELICE
13	REC57521-93910	5033192	PIÑÓN MARCHA ATRÁS	REVERSER GEAR	INGRANAGGIO MARCIA INDIETRO	PIGNON MARCHE ARRIÈRE
14	REC08110-60050	5033303	RODAMIENTO	BEARING	CUSCINETTO	ROULEMENT
15	REC09280-57002	5033010	ARO TORICO	O-RING	O-RING	JOINT TORIQUE
16	REC56120-93900	5032743	DIÁBOLO	CARRIER	DIABOLO	DIABOLO
17	PAGB/T5787-M6X20	50030396	TORNILLO	BOLT, FLANGE	VITE	VIS DE BRIDE
18	REC09289-17006	5033015	RETÉN ACEITE	OIL SEAL	PARAOLIO	JOINT SPI
19	REC57632-94J00	5033197	SEPARADOR HÉLICE	PROPELLER WASHER	DISTANZIALE ELICA	RONDELLE HÉLICE
20	REC57633-93901	5033198	SEPARADOR	SPACER	DISTANZIALE	ENTRETOISE
21	PAGB/T6170-M6	5030051	TUERCA HEXÁGONAL M6	HEXAGON NUT M6	DADO ESAGONALE M6	ECROU HEXAGONAL M6
22	PAGB/T93-6	5030068	ARANDELA MUELLE 6	SPRING WASHER 6	RONDELLA MOLLA 6	RESSORT RONDELLE 6
23	CM55300-95500	5031538	ÁNODO	ANODE	ANODO	ANODE
24	PAGB/T820-M6X20	5032945	TORNILLO M6x20	SCREW M6x20	VITE M6x20	VIS M6X20
25	REC09263-15019	5033002	RODAMIENTO	BEARING	CUSCINETTO	ROULEMENT
26	REC17452-93910	5033110	JUNTA COLA	DRIVE GASKET	GUARNIZIONE PIEDE	JOINT D'EMBASE
27	REC09289-12003	5033014	RETÉN	OIL SEAL	PARAOLIO	JOINT SPI
28	REC17450-93921	5033109	CARCASA BOMBA AGUA	PUMP BASE	BASE POMPA ACQUA	CORPS DE POMPE À EAU
29	PAGB/T818-M6X10	5030409	TORNILLO M6x10	BOLT M6x10	BULLONE M6x10	BOULON M6x10
30	REC17453-93901	5033111	TUBO VACIADO DE AGUA	WATER TUBE	TUBO ACQUA	TUBE VIDANGE D'EAU
31	REC17472-93911	5035603	JUNTA BOMBA AGUA	WATER PUMP GASKET	GUARNIZIONE POMPA ACQUA	JOINT DE POMPE À EAU
32	REC17400-93951	5033106	KIT BOMBA AGUA	WATER PUMP SERVICE KIT	KIT POMPA ACQUA	KIT POMPE À EAU
33	REC17471-93902	5033114	BASE BOMBA AGUA	WATER PUMP PLATE	COPERCHIO GIRANTE	BASE DE POMPE À EAU
34	REC17462-93990	5033113	CHAVETA	KEY	CHIAVETTA	CLAVETTE
35	REC17461-93903	5033112	IMPULSOR	IMPELLER	GIRANTE	TURBINE
36	REC17411-93901	5033107	CUERPO BOMBA AGUA	HOUSING WATER PUMP	CORPO POMPA ACQUA	CORPS DE POMPE À EAU
37	PAGB/T5783-M8X55	5032766	TORNILLO HEXAGONAL M8x55	BOLT HEXAGON M8x55	BULLONE ESAGONALE M8x55	VIS HEXAGONAL M8x55
38	REC57311-93910	5033190	PIÑÓN ATAQUE	INITIATIVE GEAR	PIGNONE ATTACCO	PIGNON D'ATTAQUE
	REC09160-20041	5032985	GRUESO 1.00	SHIM 1.00	SPESSORE 1.00	CALE 1.00
39	REC09160-20042	5032967	GRUESO 1.10	SHIM 1.10	SPESSORE 1.10	CALE 1.10
	REC09160-20043	5032968	GRUESO 1.20	SHIM 1.20	SPESSORE 1.20	CALE 1.20
	REC09160-20044	5032969	GRUESO 1.30	SHIM 1.30	SPESSORE 1.30	CALE 1.30
40	REC09160-21009	5032970	ARANDELA PIÑÓN	WASHER GEAR	RONDELLA PIGNONE	RONDELLE DE PIGNON
41	REC09263-20L04	5033003	RODAMIENTO	BEARING	CUSCINETTO	ROULEMENT
42	REC09380-15001	5033027	CIRCLIP	CLIP	CERCLIP	CLIPS
43	REC57100-93902	5033188	EJE VERTICAL	DRIVE SHAFT	ASSE VERTICALE	ARBRE DE TRANSMISSION
44	REC08110-60020	5033299	RODAMIENTO	BEARING	CUSCINETTO	ROULEMENT



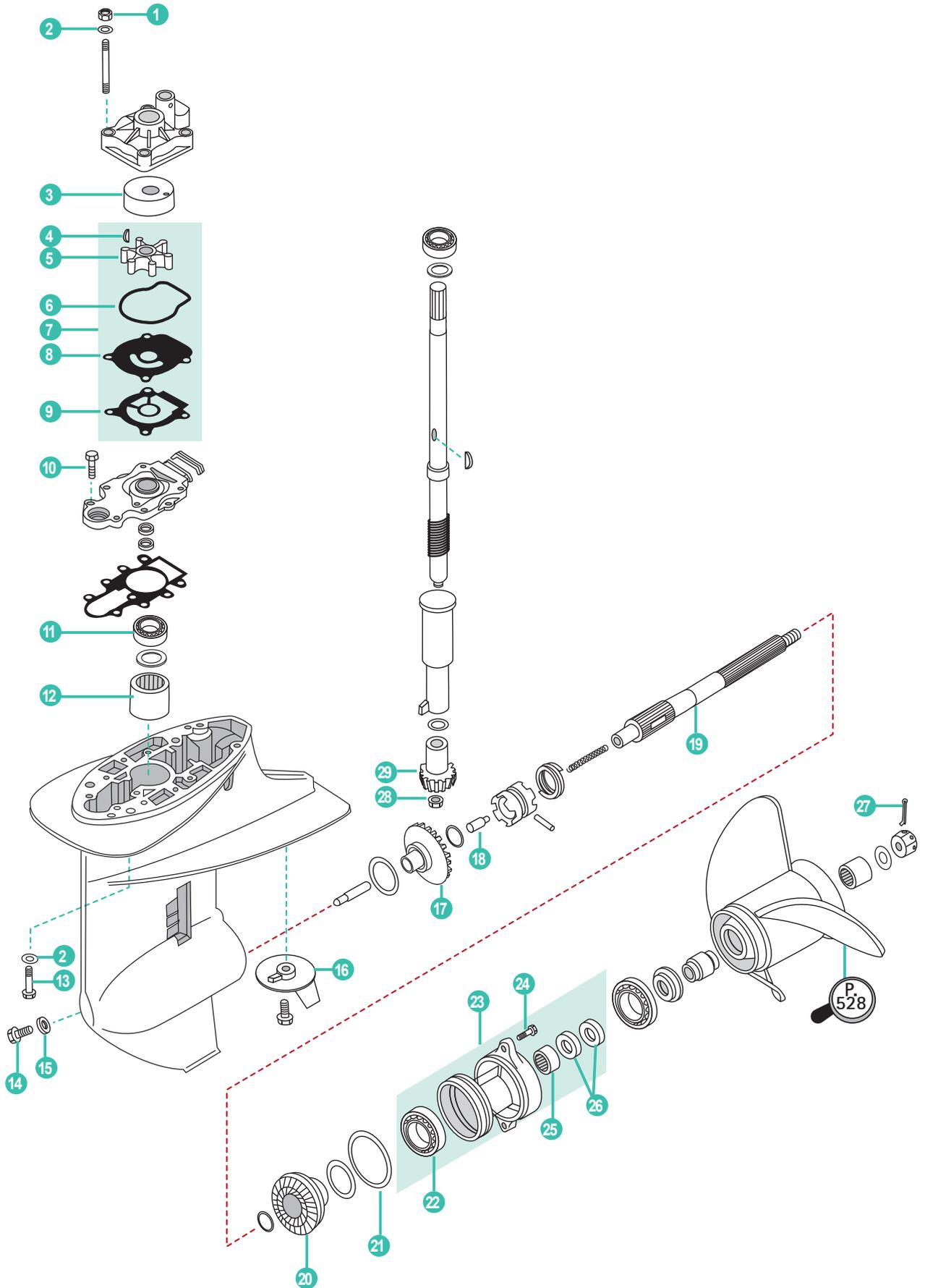

	REF	OEM				
1	PAGB/T6170-M6	5030051	TUERCA HEXÁGONO M6	NUT HEXAGON M6	DADO ESAGONALE M6	ECROU HEXAGONAL M6
2	PAGB/T848-6	5030429	ARANDELA	WASHER	RONDELLA	RONDELLE
3	REC17413-95J00	5036900	CASQUILLO INOX	SLEEVE WATER PUMP	CAPPUCCIO	INSERT DE POMPE À EAU
4	REC09420-04006	5031281	CHAVETA	KEY	CHIAVETTA	CLAVETTE
5	REC17461-96312	5031417	IMPULSOR	IMPELLER	GIRANTE	TURBINE
6	REC17416-95J00	5036901	ARO TÓRICO	O-RING	FASCIA TONDA	JOINT TORIQUE
7	REC17400-95J02	5036908	KIT BOMBA DE AGUA	WATER PUMP KIT	KIT POMPA ACQUA	KIT POMPE A EAU
8	REC17471-95J01	5036902	TAPA DEL IMPULSOR	OUTER PLATE CARTRIDGE	COPERCHIO GIRANTE	PLAQUE DE POMPE À EAU
9	REC17472-96303	5036681	JUNTA DE LA BOMBA DE AGUA	WATER PUMP, GASKET	GUARNIZIONE POMPA ACQUA	JOINT POMPE À EAU
10	REC09116-06094	5030034	TORNILLO 6x15	SCREW 6x15	VITE 6x15	VIS 6x15
11	REC09265-17002	5031885	RODAMIENTO	BEARING	CUSCINETTO	ROULEMENT
12	REC09263-20046	5031883	RODAMIENTO	BEARING	CUSCINETTO	ROULEMENT
13	PAGB/T5787-M6X30	5030394	TORNILLO M6x30	BOLT M6x30	BULLONE M6x30	BOULON M6x30
14	REC09248-10008	5030094	TORNILLO 10x7,5	SCREW 10x7,5	VITE 10x7,5	VIS M10x7,5
15	REC09168-10022	5030071	ARANDELA TAPÓN	CAP, O-RING	RONDELLA TAPPO	JOINT DE VIDANGE
16	REC55125-91L01AL	5032091	ÁNODO	ANODE	ANODO	ANODE
17	REC57510-89J00	5032689	PIÑÓN MARCHA AVANTE	POSITIVE GEAR	PIGNONE MARCIA AVANTI	PIGNON MARCHE AVANT
18	REC09209-08016	5031880	VARILLA PRESION ACEITE	ROD PUSH	ASTA PRESSIONE OLIO	CLAVETTE
19	REC57610-96311	5032101	EJE HELICE	PROPELLER SHAFT	ASSE ELICA	ARBRE D'HELICE
20	REC57521-89J00	5032100	PIÑÓN MARCHA ATRÁS	REVERSER GEAR	PIGNONE MARCIA INDIETRO	PIGNON MARCHE ARRIÈRE
21	REC09280-75001	5031263	ARO TÓRICO	O-RING	FASCIA TONDA	JOINT TORIQUE
22	REC08113-60060	5032295	RODAMIENTO	BEARING	CUSCINETTO	ROULEMENT
23	REC56120-96332-OEP	5034711	DIÁBOLO	CARRIER	DIAVOLO	DIABOLO
24	REC09116-06121	5030391	TORNILLO	BOLT	VITE	VIS
25	REC09263-20047	5031884	RODAMIENTO	BEARING	CUSCINETTO	ROULEMENT
26	REC09289-20009	5031893	RETÉN ACEITE	OIL SEAL	PARAOILIO	JOINT SPI
27	REC91490-30025	5030087	PIN BLOQUEADOR	COTTER PIN	COPPIGLIA	GOUPILLE
28	REC90179-08M06	5031827	TUERCA DE PIÑÓN M8X1	NUT, PINION M8X1	DADO PIGNONE M8X1	ECROU DE PIGNON M8
29	REC57311-96320	5032098	PIÑÓN ATAQUE	INITIATIVE GEAR	PIGNONE ATTACCO	PIGNON D'ATTAQUE

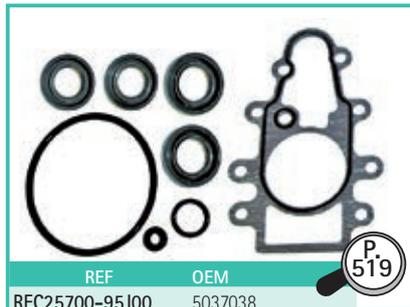

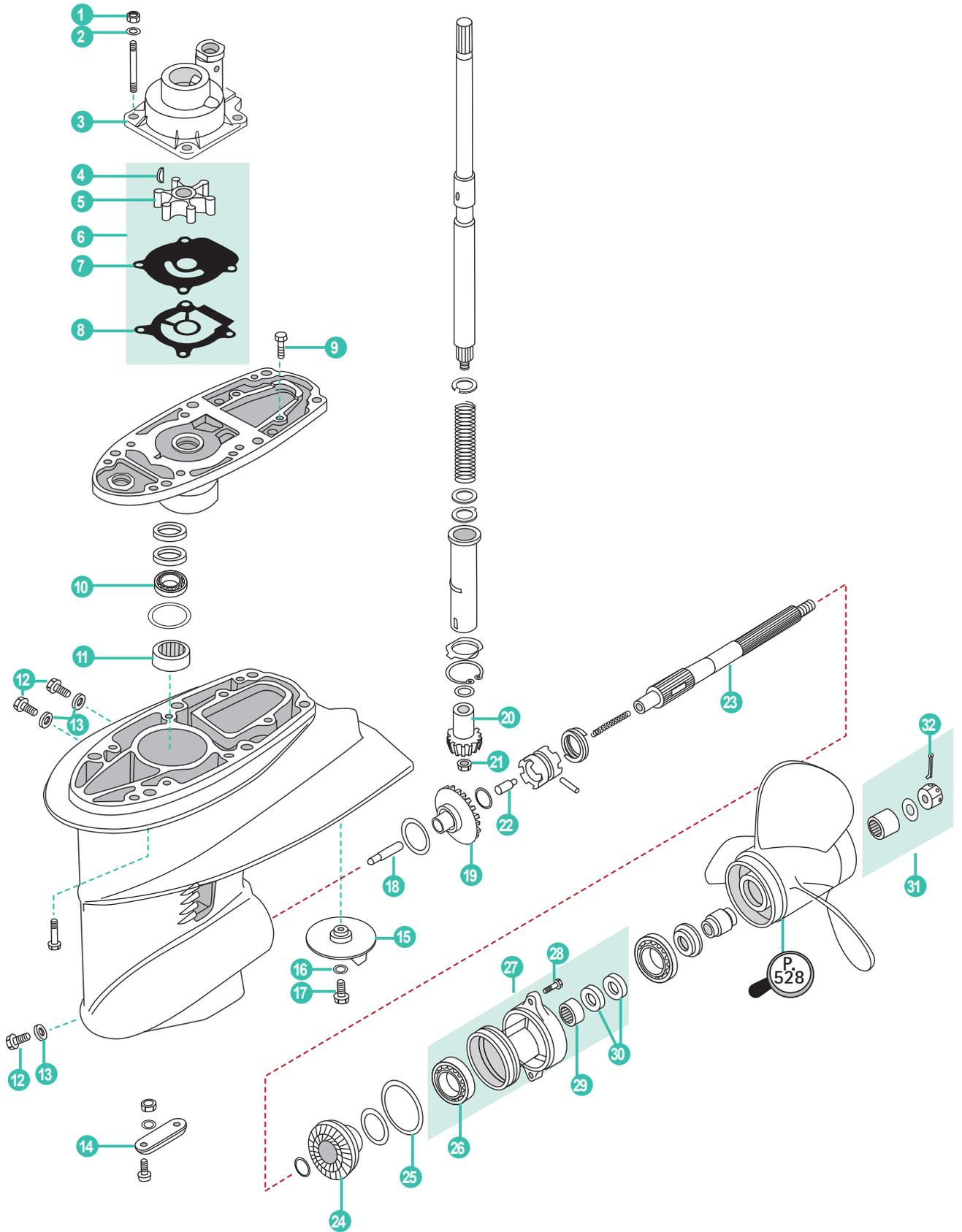

	REF	OEM				
1	PAGB/T6184-2000	5030051	TUERCA M6	NUT M6	DADO M6	ÉCROU M6
2	PAGB/T848-6	5030068	ARANDELA	WASHER	RONDELLA	RONDELLE
3	REC17411-94421	5031990	CUERPO BOMBA AGUA	HOUSING WATER PUMP	CORPO POMPA ACQUA	CORPS DE POMPE À EAU
4	REC09420-04006	5031281	CHAVETA	KEY	CHIAVETTA	CLAVETTE
5	REC17461-96312	5031417	IMPULSOR	IMPELLER	GIRANTE	TURBINE
6	REC17400-96403	5031744	KIT BOMBA DE AGUA	WATER PUMP KIT	KIT POMPA ACQUA	KIT POMPE A EAU
7	REC17471-94401	5031418	BASE BOMBA AGUA	PLATE, WATER PUMP	BASE POMPA ACQUA	BASE DE POMPE À EAU
8	REC17472-96303	5036681	JUNTA DE LA BOMBA DE AGUA	WATER PUMP, GASKET	GUARNIZIONE POMPA ACQUA	JOINT POMPE À EAU
9	PAGB/T5787-M6X20	5030037	TORNILLO	BOLT, FLANGE	VITE	VIS DE BRIDE
10	REC09265-17002	5031885	RODAMIENTO	BEARING	CUSCINETTO	ROULEMENT
11	REC09263-20046	5031883	RODAMIENTO	BEARING	CUSCINETTO	ROULEMENT
12	REC09248-10008	5030094	TORNILLO 10x7,5	SCREW 10x7,5	VITE 10x7,5	VIS 10x7,5
13	REC09168-10022	5030071	ARANDELA TAPÓN	CAP, O-RING	RONDELLA TAPPO	JOINT DE VIDANGE
14	CM55300-95500	5031538	ÁNODO	ANODE	ANODO	ANODE
15	REC55125-91L01AL	5032191	ÁNODO	ANODE	ANODO	ANODE
16	PAGB/T97.1-8		ARANDELA 8	WASHER 8	RONDELLA 8	RONDELLE 8
17	PAGB/T5783-M8X16	5031215	TORNILLO M8x16	BOLT M8x16	BULLONE M8x16	BOULON M8x16
18	REC57631-96301	5032103	VARILLA PRESION ACEITE	ROD PUSH	ASTA PRESSIONE OLIO	CLAVETTE
19	REC57510-89J00	5032698	PIÑÓN MARCHA AVANTE	POSITIVE GEAR	PIGNONE MARCIA AVANTI	PIGNON MARCHE AVANT
20	REC57311-96320	5032098	PIÑÓN ATAQUE	INITIATIVE GEAR	PIGNONE ATTACCO	PIGNON D'ATTAQUE
21	REC90179-08M06	5031827	TUERCA DE PIÑÓN M8X1	NUT, PINION M8X1	DADO PIGNONE M8X1	ECROU DE PIGNON M8
22	REC09209-08016	5031880	VARILLA PRESION ACEITE	ROD PUSH	ASTA PRESSIONE OLIO	CLAVETTE
23	REC57610-96311	5032101	EJE HELICE	PROPELLER SHAFT	ASSE ELICA	ARBRE D'HELICE
24	REC57521-89J00	5032100	PIÑÓN MARCHA ATRÁS	REVERSER GEAR	PIGNONE MARCIA INDIETRO	PIGNON MARCHE ARRIÈRE
25	REC925093	5031890	ARO TORICO SUPERIOR	O-RING UPPER	O-RING SUPERIORE	JOINT TORIQUE SUPERIEUR
26	REC08113-60060	5032295	RODAMIENTO	BEARING	CUSCINETTO	ROULEMENT
27	REC56120-96332-0EP	5034711	DIÁBOLO	CARRIER	DIABOLO	DIABOLO
28	REC09116-06121	5030391	TORNILLO	BOLT	VITE	VIS
29	REC09263-20047	5031884	RODAMIENTO	BEARING	CUSCINETTO	ROULEMENT
30	REC09289-20009	5031893	RETÉN ACEITE	OIL SEAL	PARAOILIO	JOINT SPI
31	REC57630-96300	5032170	KIT CIERRE DE HÉLICE	PROP NUT KIT	KIT CHIUSURA ELICA	KIT ECROU D'HELICE
32	REC91490-30025	5030087	PIN BLOQUEADOR	COTTER PIN	COPPIGLIA	GOUPILLE



REC80W90U3
REC80W90U6
REC9REU1
REC9REU12

P. 43



REF OEM
REC25700-95D01 5032167

P. 519

4T DF40, DF50
STROKES

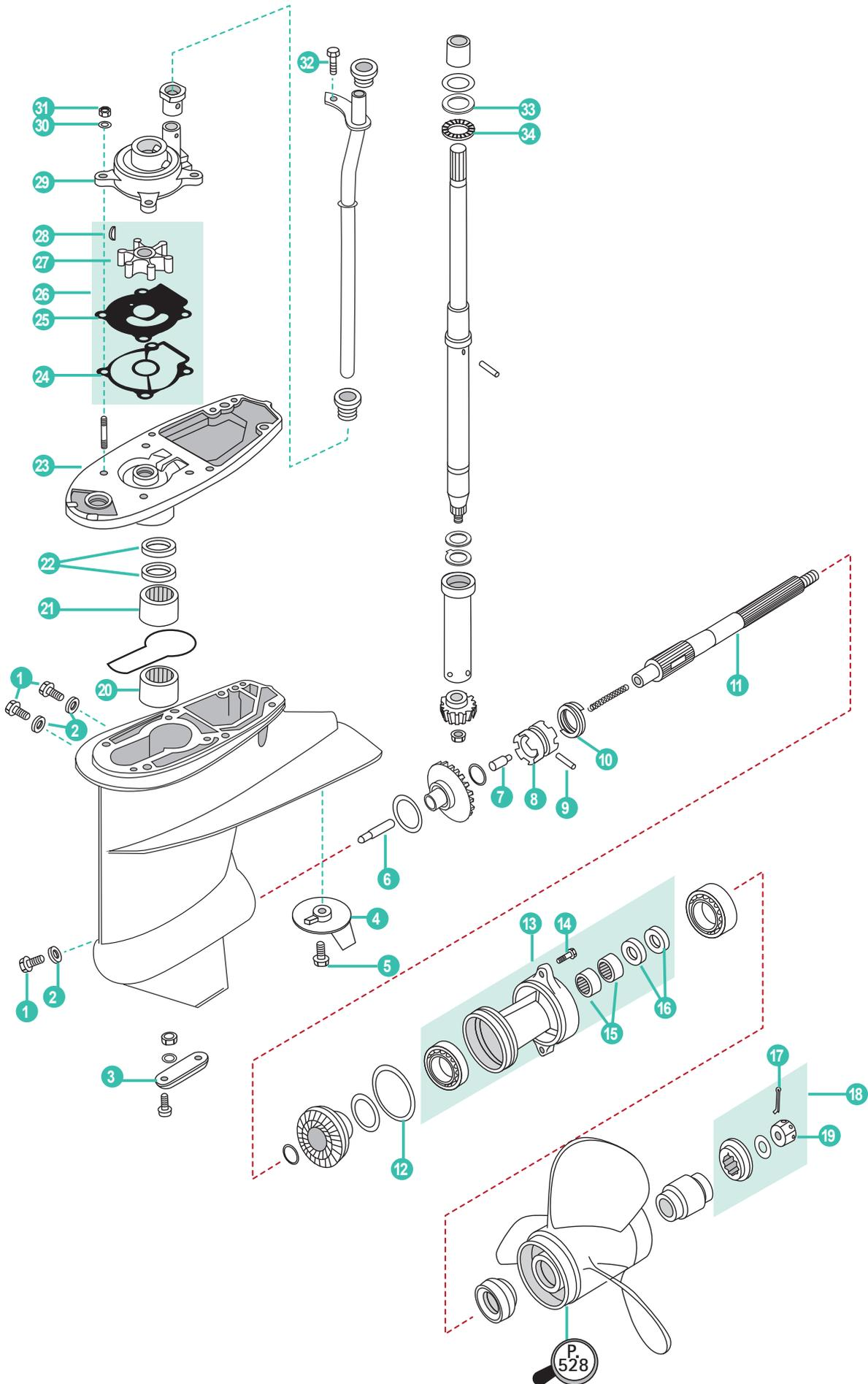

	REF	OEM				
1	REC09248-10008	5030094	TORNILLO 10x7,5	SCREW 10x7,5	VITE 10x7,5	VIS M10x7,5
2	REC09168-10022	5030071	ARANDELA TAPÓN	CAP, O-RING	RONDELLA TAPPO	JOINT DE VIDANGE
3	CM55300-95500	5031538	ÁNODO	ANODE	ANODO	ANODE
4	REC55125-95500AL	5031536	ÁNODO	ANODE	ANODO	ANODE
5	PAGB/T5783-M8X16	5031215	TORNILLO M8x16	BOLT M8x16	BULLONE M8x16	BOULON M8x16
6	REC57631-95303	5031549	VARILLA PRESION ACEITE	ROD PUSH	ASTA PRESSIONE OLIO	CLAVETTE
7	REC57634-88L00	5031251	PIN SELECTOR	CLUTCH PIN	PIN SELETTORE	CALVETTE
8	REC57621-94403	5036059	SELECTOR	SELETTORE	CLUTCH DOG	CRABOT
9	REC09202-04002	5030084	PIN HELICE	PROPELLER PIN	PIN ELICA	CLAVETTE D'HELICE
10	REC09440-40002	5031286	MUELLE SELECTOR	SPRING CLUTCH	MOLLA SELETTORE	RESSORT
11	REC57610-94402	5031546	EJE HELICE	PROPELLER SHAFT	ASSE ELICA	ARBRE D'HELICE
12	REC09280-75001	5031263	ARO TÓRICO	O-RING	FASCIA TONDA	JOINT TORIQUE
13	REC56120-94321-0EP	5032801	DIÁBOLO	CARRIER	DIABOLO	DIABOLO
14	PAGB/T5783-M8X30	5031216	TORNILLO M8x30	BOLT M8x30	BULLONE M8x30	BOULON M8x30
15	REC09263-22020	5031255	RODAMIENTO	BEARING	CUSCINETTO	ROULEMENT
16	REC09289-22007	5031270	RETÉN ACEITE	OIL SEAL	PARAOLIO	JOINT SPI
17	REC91490-30025	5030087	PIN BLOQUEADOR	COTTER PIN	COPPIGLIA	GOUPILLE
18	REC57630-94300	5031548	KIT CIERRE DE HÉLICE	PROP NUT KIT	KIT CHIUSURA ELICA	KIT ECROU D'HELICE
19	REC90171-18M04	5030422	TUERCA	NUT	DADO	ÉCROU
20	REC09263-22L03	5031256	RODAMIENTO	BEARING	CUSCINETTO	ROULEMENT
21	REC09263-25025	5031257	RODAMIENTO	BEARING	CUSCINETTO	ROULEMENT
22	REC09282-17005	5031264	RETÉN ACEITE	OIL SEAL	PARAOLIO	JOINT SPI
23	REC56130-94413-0EP	5032802	DIÁBOLO	CARRIER	DIABOLO	DIABOLO
24	REC17472-96303	5036681	JUNTA DE LA BOMBA DE AGUA	WATER PUMP, GASKET	GUARNIZIONE POMPA ACQUA	JOINT POMPE À EAU
25	REC17471-94401	5031418	BASE BOMBA AGUA	PLATE, WATER PUMP	BASE POMPA ACQUA	BASE DE POMPE À EAU
26	REC17400-96403	5031744	KIT BOMBA DE AGUA	WATER PUMP KIT	KIT POMPA ACQUA	KIT POMPE A EAU
27	REC17461-96312	5031417	IMPULSOR	IMPELLER	GIRANTE	TURBINE
28	REC09420-04006	5031281	CHAVETA	KEY	CHIAVETTA	CLAVETTE
29	REC17411-94421	5031990	CUERPO BOMBA AGUA	HOUSING WATER PUMP	CORPO POMPA ACQUA	CORPS DE POMPE À EAU
30	PAGB/T93-6	5030068	ARANDELA 6	WASHER 6	RONDELLA 6	RONDELLE 6
31	PAGB/T6170-M6	5030051	TUERCA HEXÁGONO M6	NUT HEXAGON M6	DADO ESAGONALE M6	ECROU HEXAGONAL M6
32	REC09116-06094	5030034	TORNILLO 6x15	SCREW 6x15	VITE 6x15	VIS 6x15
33	REC09160-26015	5031232	ARANDELA PIÑÓN	WASHER GEAR	RONDELLA PIGNONE	RONDELLE DE PIGNON
34	REC09263-25062	5031258	RODAMIENTO	BEARING	CUSCINETTO	ROULEMENT



4T J/BJ 60, 70 HP
STROKES

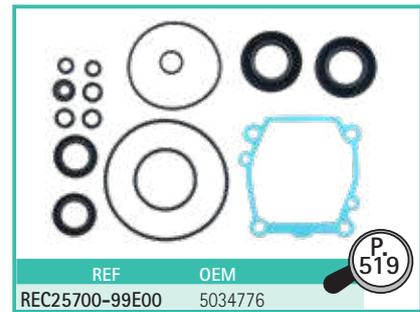
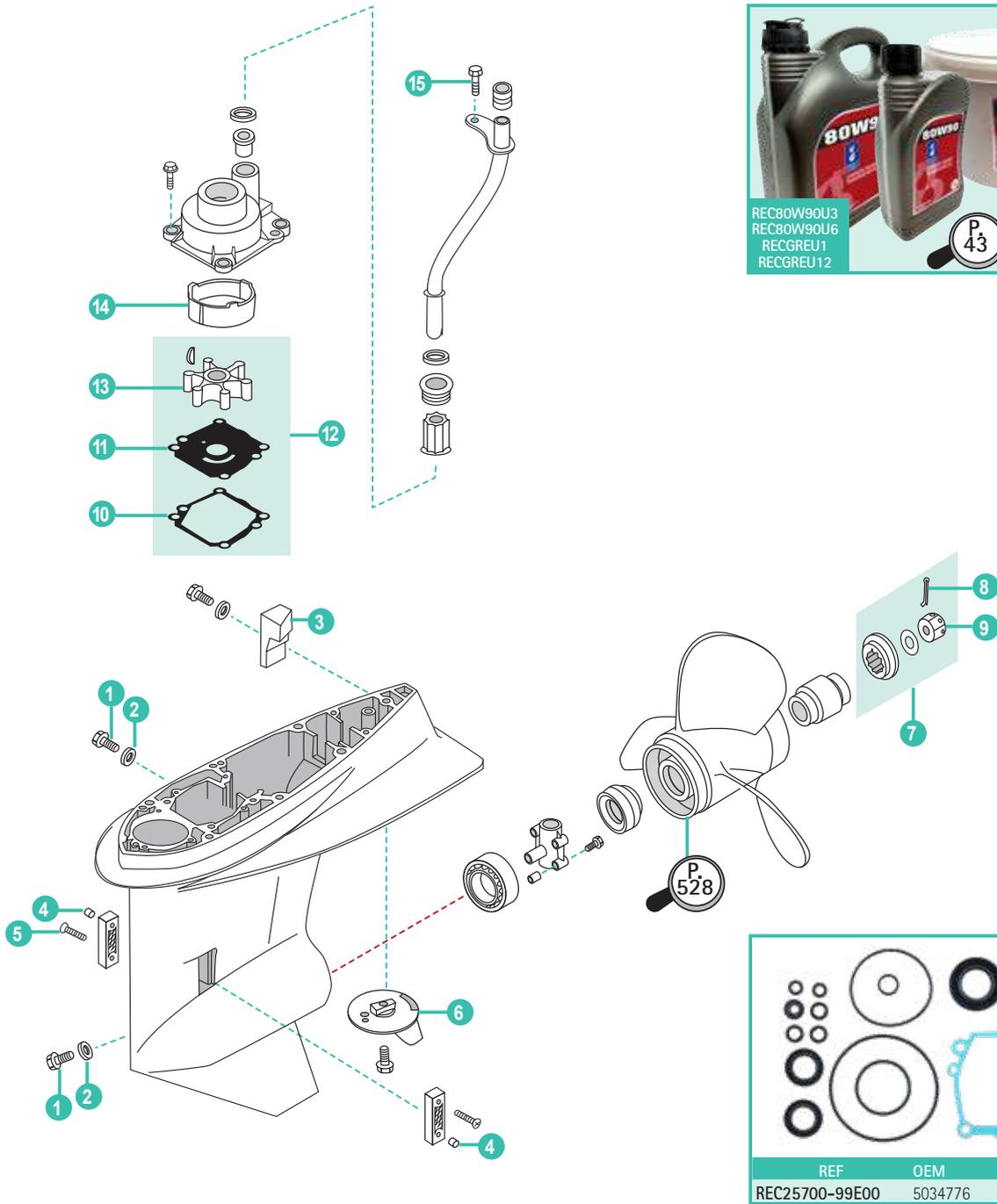

	REF	OEM				
1	REC09248-10008	5030094	TORNILLO 10x7,5	SCREW 10x7,5	VITE 10x7,5	VIS 10x7,5
2	REC09168-10022	5030071	ARANDELA TAPÓN	CAP, O-RING	RONDELLA TAPPO	JOINT DE VIDANGE
3	REC55321-90J01AL	5032930	ÁNODO	ANODE	ANODO	ANODE
4	PAGB/T889.1-M4	5030415	TUERCA HEXAGONAL M4	NUT HEXAGON M4	DADO ESAGONALE M4	ECROU HEXAGONAL M4
5	PAGB/T818-M4X30	5030405	TORNILLO M4x30	SCREW PAN HEAD M4x30	VITE TESTA M4x30	VIS M4x30
6	REC55125-90J01AL	5032929	ÁNODO	ANODE	ANODO	ANODE
7	REC57630-94500	5030967	KIT CIERRE HELICE	PROP NUT KIT	KIT CHIUSURA ELICA	KIT ECROU D'HELICE
8	REC91490-30025	5030087	PIN BLOQUEADOR	COTTER PIN	COPPIGLIA	GOUILLE
9	REC90171-18M04	5030422	TUERCA	NUT	DADO	ÉCROU
10	REC17472-87E10	5030725	JUNTA BOMBA AGUA	WATER PUMP GASKET	GUARZIONE POMPA ACQUA	JOINT DE POMPE À EAU
11	REC17471-92J00	5034651	PLACA BOMBA DE AGUA	PATE, WATER PUMP	PLACCA POMPA ACQUA	PLAQUE DE POMPE A EAU
12	REC17400-87E04	5031731	KIT REPARACION BOMBA AGUA	WATER PUMP KIT	KIT RIPARAZIONE POMPA ACQUA	KIT TURBINE
13	REC17461-87E12	5030723	IMPULSOR	IMPELLER	GIRANTE	TURBINE
14	REC17413-99E11		CASQUILLO INOX	INSERT CUP	GHIERA INOX	INSERT INOX POMPE A EAU
15	PAGB/T5783-M6X16	5030038	TORNILLO HEXAGONAL M6x16	BOLT HEXAGON M6x16	BULLONE ESAGONALE M6x16	BOULON HEXAGONAL M6x16

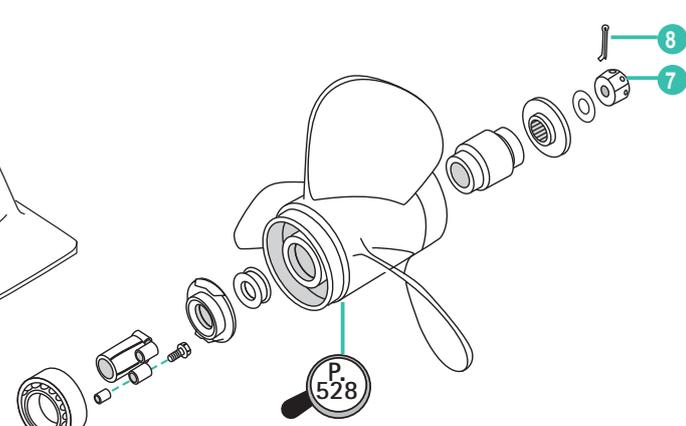
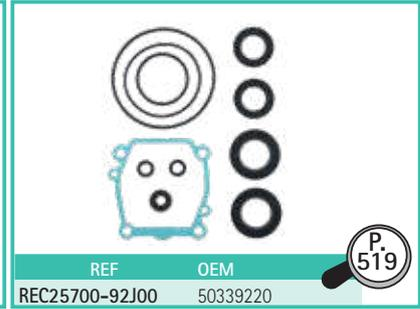
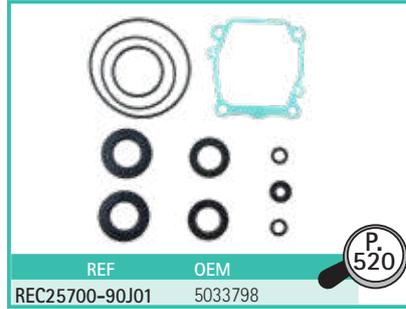
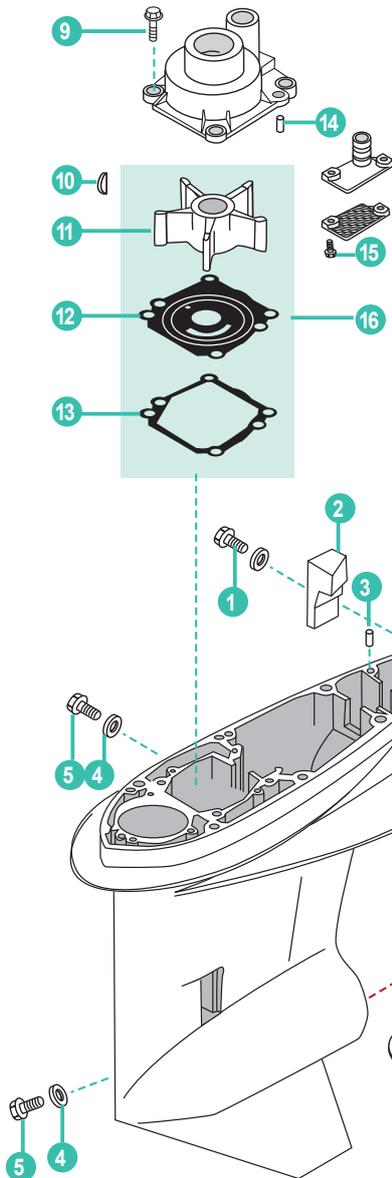

	REF	OEM				
1	PAGB/T5783-M6X12	5030338	TORNILLO M6x12	BOLT M6x12	BULLONE M6x12	BOULON M6x12
2	REC55321-90J01AL	5032930	ÁNODO	ANODE	ANODO	ANODE
3	PAF25-00000014	5030511	PIN CENTRADOR F8x12	PIN, DOWEL F8x12	PIN, CENTRAGGIO F8x12	GOUPILLE FENDUE 8x12
4	REC09168-10022	5030071	TORNILLO 10x7,5	SCREW 10x7,5	VITE 10x7,5	VIS M10x7,5
5	REC09248-10008	5030094	ARANDELA TAPÓN	CAP, O-RING	RONDELLA TAPPO	JOINT DE VIDANGE
6	REC55125-90J01AL	5032929	ÁNODO	ANODE	ANODO	ANODE
7	REC90171-18M04	5030422	TUERCA	NUT	DADO	ÉCROU
8	REC91490-30025	5030087	PIN BLOQUEADOR	COTTER PIN	COPPIGLIA	GOUPILLE
9	PAGB/T5783-M8X25	5030398	PERNO M8X25	BOLT M8X25	BULLONE M8	BOULON M8X25
10	REC09420-05009	5034842	CHAVETA	KEY	CHIAVETTA	CLAVETTE
11	REC17461-90J01	5033542	IMPULSOR	IMPELLER	GIRANTE	TURBINE
12	REC17471-92J00	5037170	TAPA DEL IMPULSOR	OUTER PLATE CARTRIDGE	COPERCHIO GIRANTE	PLAQUE DE POMPE À EAU
13	REC17472-87E10	5030725	JUNTA BOMBA AGUA	WATER PUMP GASKET	GUARZIONE POMPA ACQUA	JOINT DE POMPE À EAU
14	REC93606-12019	5030508	PIN F6X12	PIN F6X12	SPINOTTO F6X12	LEVIER F6X12
15	PAGB/T8.8-2000	5030406	TORNILLO M5X12	SCREW, PAN HEAD M5X12	VITE M5X12	VIS M5X12
16	REC17400-90J20	5033541	KIT BOMBA DE AGUA	WATER PUMP KIT	KIT POMPA ACQUA	KIT POMPE A EAU

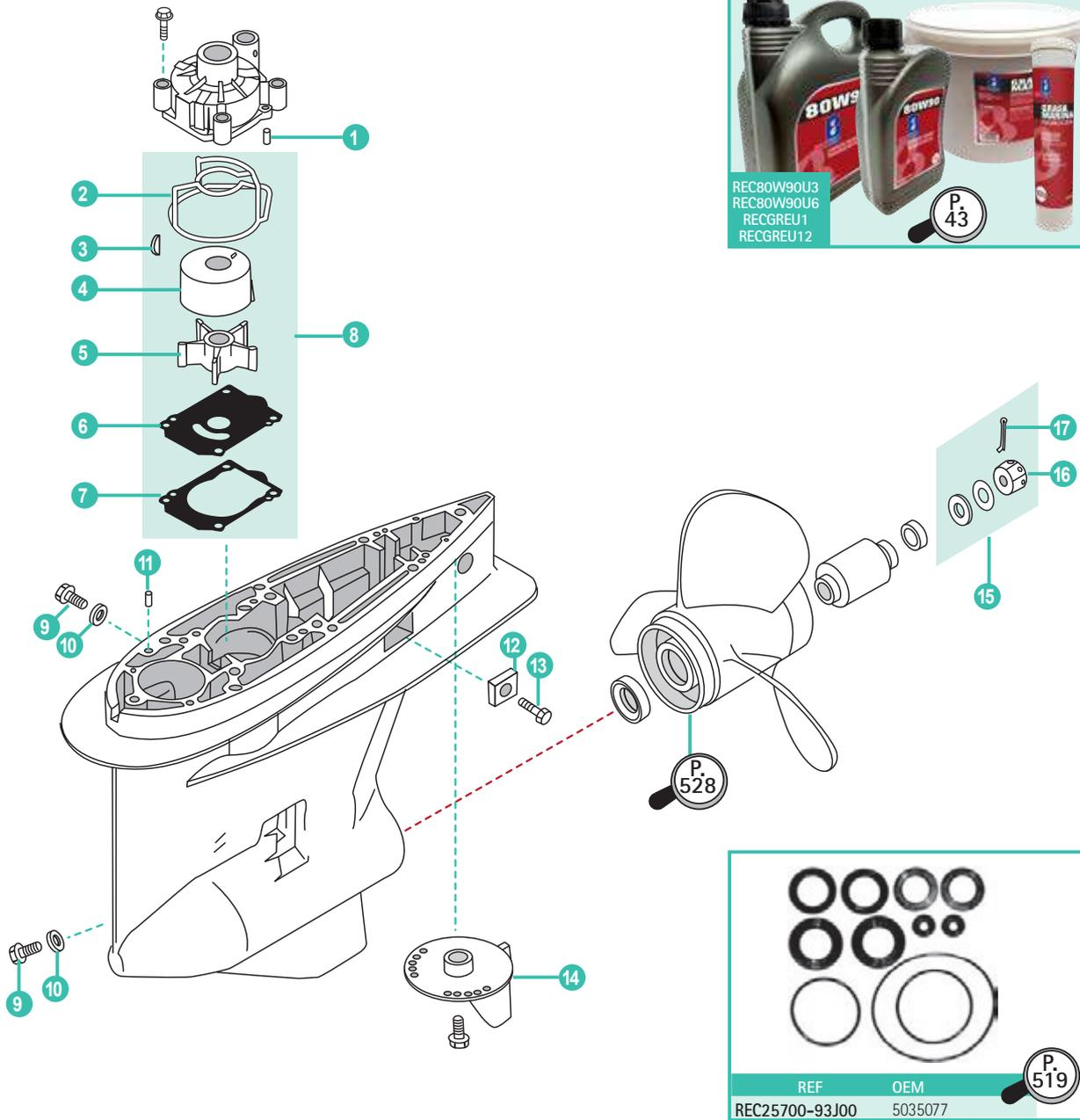

REF	OEM					
1	REC93606-12019	5030508	PIN F6X12	PIN F6X12	SPINOTTO F6X12	PIN F6X12
2	REC17416-96J00	5035039	JUNTA TORICA	O-RING	O-RING	JOINT TORIQUE
3	REC09420-05009	5034842	CHAVETA	KEY	CHIAVETTA	CLAVETTE
4	REC17413-96J01	5035038	CASQUILLO INOX	SLEEVE WATER PUMP	CAPPUCCIO	INSERT DE POMPE À EAU
5	REC17461-90J01	5033542	IMPULSOR	IMPELLER	GIRANTE	TURBINE
6	REC17471-92J02	5035041	TAPA DEL IMPULSOR	IMPELLER PLATE	COPERCHIO GIRANTE	PLAQUE DE POMPE À EAU
7	REC17472-93J00	5035042	JUNTA	GASKET	GUARNIZIONE	JOINT
8	REC17400-96J03	5035036	KIT BOMBA DE AGUA	WATER PUMP KIT	KIT POMPA ACQUA	KIT POMPE A EAU
9	REC55128-93J10	5035151	TAPON DRENAJE COLA	WATER PLUG DRAIN	GUARNIZIONE DRENAGGIO	BOUCHON DE VIDANGE
10	REC09168-10034	5034799	JUNTA	GASKET	GUARNIZIONE	JOINT
11	PAF25-00000014	5030511	PIN CENTRADOR F8x12	PIN, DOWEL F8x12	PIN, CENTRAGGIO F8x12	GOUPILLE FENDUE 8x12
12	REC55320-95311AL	5035786	ÁNODO	ANODE	ANODO	ANODE
13	REC09116-06094	5030034	TORNILLO 6x15	SCREW 6x15	VITE 6x15	VIS M6x15
14	REC55125-90J01AL	5035150	ÁNODO	ANODE	ANODO	ANODE
15	REC57630-92E00	5035460	KIT CIERRE HELICE	PROP NUT KIT	KIT CHIUSURA ELICA	KIT ECROU D'HELICE
16	REC90171-18M04	5030422	TUERCA	NUT	DADO	ÉCROU
17	REC91490-30025	5030087	PIN BLOQUEADOR	COTTER PIN	COPPIGLIA	GOUPILLE

DESPIECE COLAS
2 TIEMPOS

GEAR CASE PARTS
2 STROKES

PAR TI PIEDI
DE 2 TEMPI

PIECES D'EMBASES DE 2
TEMPS

2T 4, 4.5, 5, 6, 7.5, 8 HP (1980+)
STROKES

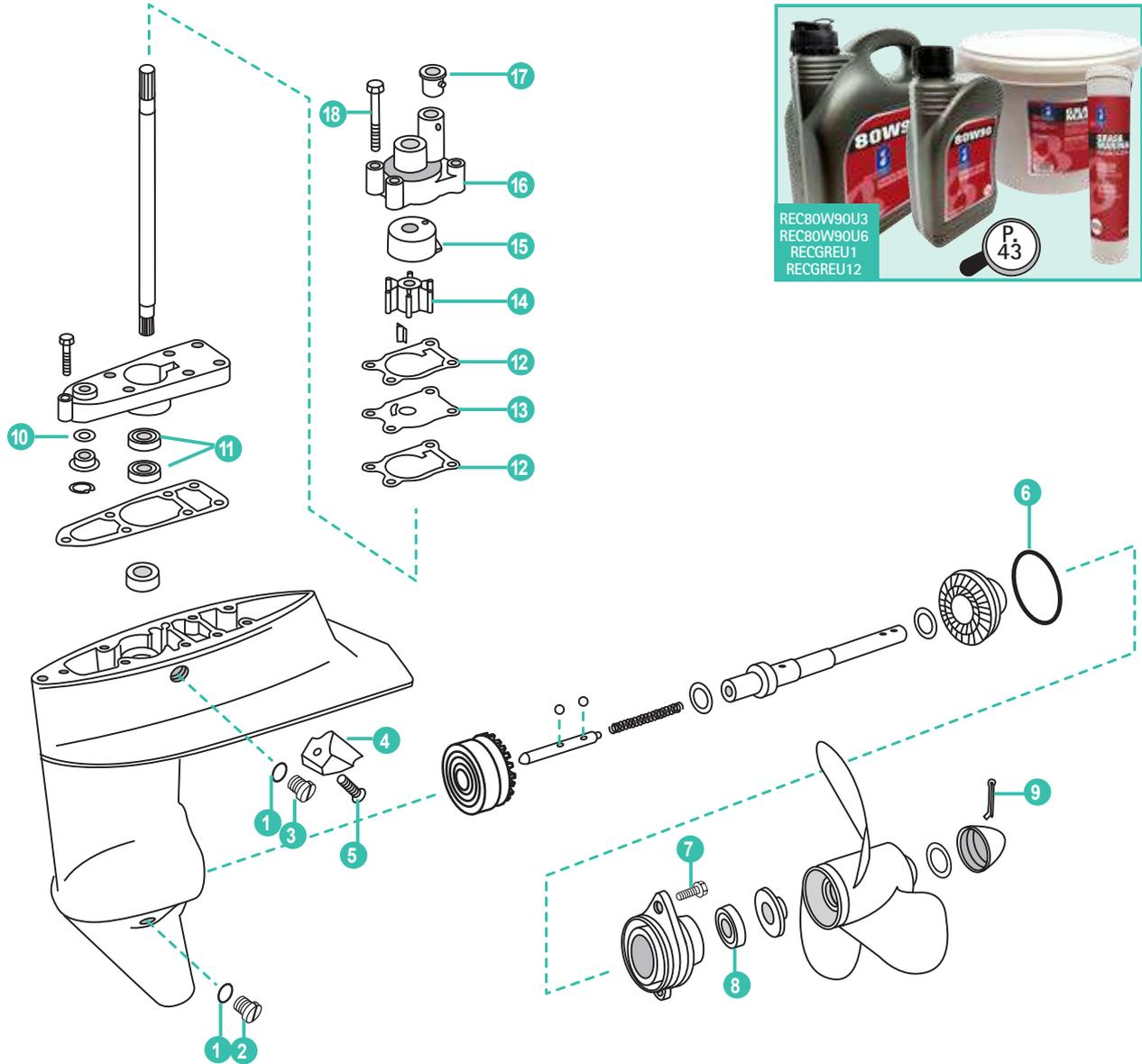

	REF	OEM				
1	REC12-191833	307552	JUNTA	GASKET	GUARNIZIONE	JOINT DE VIDANGE
2	REC22-67892A05	318544	JUEGO TORNILLOS DRENAJE	DRAINING SCREW SET	KIT VITERIA DRENAGGIO	BOUCHON DE VIDANGE MAGNETIQUE + JOINT
3	REC10-79953Q04	307551	JUEGO TORNILLOS	SCREW SET	KIT VITERIA	BOUCHON + JOINT VIDANGE
4	CM334451A	334451	ÁNODO	ANODE	ANODO	ANODE
5	REC328725	328725	TORNILLO	SCREW	VITE	VIS
6	REC322494	322494	JUNTA TORICA	O-RING	O-RING	JOINT TORIQUE
7	REC328744	328744	TORNILLO	SCREW	VITE	VIS
8	REC336493	336493	RETÉN ACEITE	OIL SEAL	PARAOILIO	JOINT SPI
9	REC3852056	306394	PASADOR	COTTER PIN	CHIAVISTELLO	GOUPILLE
10	REC305242	305242	JUNTA TORICA	O-RING	O-RING	JOINT TORIQUE
11	REC324639	324639	RETÉN ACEITE	OIL SEAL	PARAOILIO	JOINT SPI
12	REC325040	325040	JUNTA	GASKET	GUARNIZIONE	JOINT
13	REC324640	324640	TAPA	WEAR PLATE	COPERCHIO	COUVERCLE
14	REC389576	436137	IMPULSOR	IMPELLER	GIRANTE	TURBINE
15	REC324641	324641	TAPA BOMBA	PUMP CUP	COPERCHIO POMPA	INSERT DE POMPE
16	REC389577	389577	CUERPO BOMBA	PUMP HOUSING	CORPO POMPA	CORSP DE POMPE
17	REC302497	302497	GRUESO 20"	GROMMET 20"	SPESSORE 20"	CALE 20"
18	REC331980	331980	TORNILLO	SCREW	VITE	VIS

2T 9.9, 15 HP (1974+)
STROKES

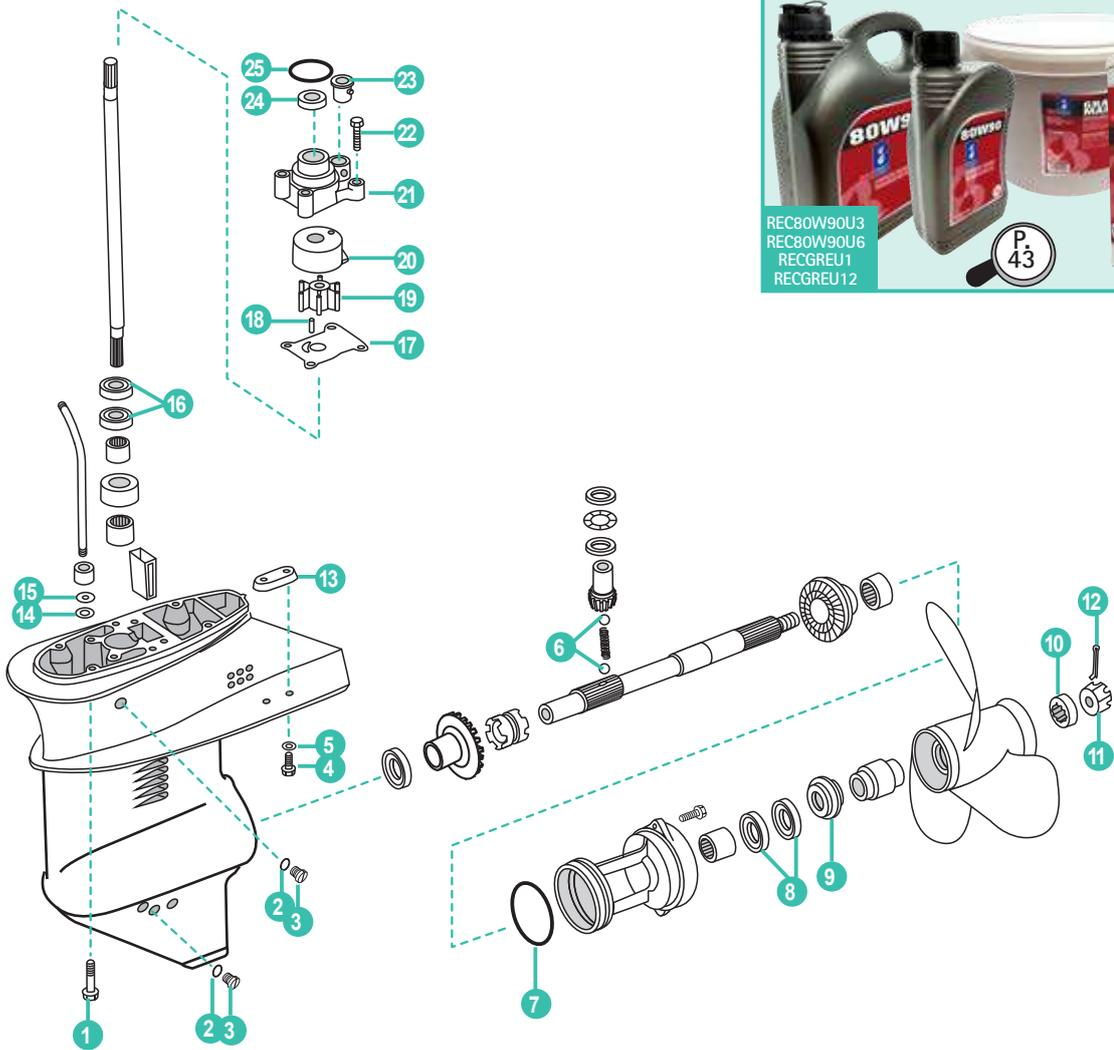

REC80W90U3
REC80W90U6
RECGREU1
RECGREU12

P. 43

REF	OEM				
1	REC324334	324334	TORNILLO	SCREW	VITE VIS
2	REC12-191833	307552	JUNTA	GASKET	GUARNIZIONE JOINT DE VIDANGE
3	REC10-79953Q04	307551	JUEGO TORNILLO	SCREW SET	KIT VITERIA VIS DE VIDANGE
4	REC306643	306643	TORNILLO	SCREW	VITE VIS
5	REC304454	304454	CIERRE	LOCKWASHER	CHIUSURA RONDELLE
6	REC316506	316506	BOLA	DETENT BALL	FERMO SFERA BILLE
7	REC308627	308627	TÓRICA	O-RING	O-RING JOINT TORIQUE
8	REC321481	321481	RETÉN ACEITE	OIL SEAL	PARAOLIO JOINT SPI
9	REC334590	334590	CIERRE	THRUST WASHER	CHIUSURA ENTRETOISE POUR HELICE
10	REC323942	323942	ESPACIADOR	SPACER	DISTANZIATORE RONDELLE D'HELICE
11	REC318971	318971	TUERCA	NUT	DADO ÉCROU
12	REC328522	328522	PASADOR	COTTER PIN	CHIAVISTELLO GOUPILLE FENDUE
13	CM123009	173029	ÁNODO	ANODE	ANODO ANODE
14	REC321738	321738	ARANDELA	WASHER	RONDELLA RONDELLE
15	REC301877	301877	TÓRICA	O-RING	O-RING JOINT TORIQUE
16	REC321480	321480	RETÉN ACEITE	OIL SEAL	PARAOLIO JOINT SPI
17	REC318995	318995	TAPA	WEAR PLATE	COPERCHIO COUVERCLE
18	REC300611	300611	CHAVETA	KEY	CHIAVE CLAVETTE
19	REC386084	386084	IMPULSOR	IMPELLER	GIRANTE TURBINE
20	REC324097	324097	TAPA BOMBA	PUMP CUP	COPERCHIO POMPA INSERT DE POMPE
21	REC435390	435390	CUERPO BOMBA	PUMP HOUSING	CORPO POMPA CORPS DE POMPE
22	REC302325	302325	TORNILLO	SCREW	VITE VIS
23	REC302497	302497	GRUESO	GROMMET	SPESSORE CALE
24	REC318972	318972	RETÉN ACEITE	OIL SEAL	PARAOLIO JOINT SPI
25	REC319085	319085	TÓRICA	O-RING	O-RING JOINT TORIQUE

2T 20 - 35 HP 2 CYL CROSSFLOW (1980-05) • 25, 30, 35 HP 3 CYL LOOPCHARGED (1996-01)
 STROKES ESCAPE POR HÉLICE | THRU-PROP EXHAUST | SCARICO ALL'ELICA | ÉCHAPPEMENT PAR HÉLICE

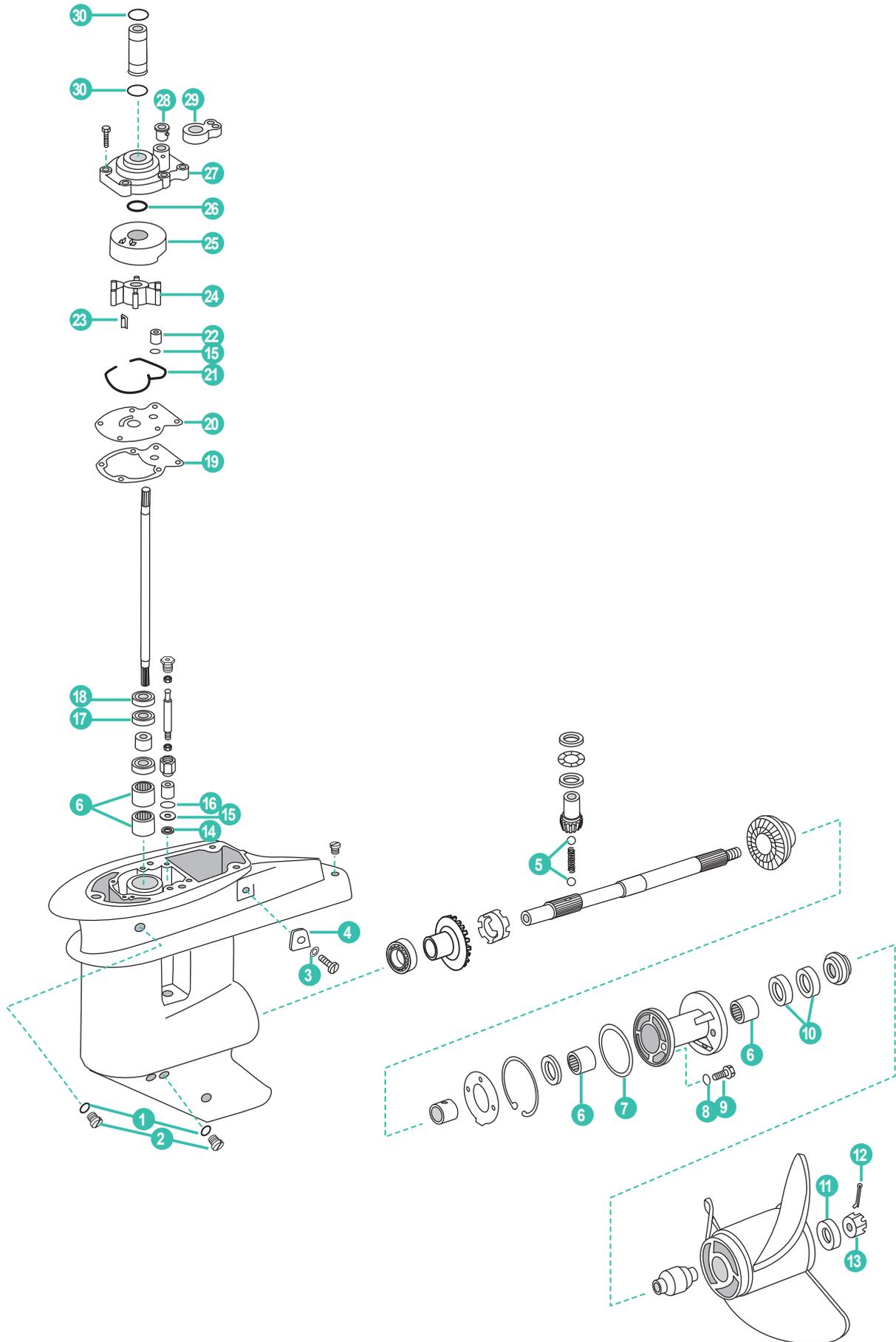

	REF	OEM				
1	REC3855081	311598	JUNTA	GASKET	GUARNIZIONE	JOINT
2	REC10-79953Q04	307551	JUEGO TORNILLOS	SCREW SET	KIT VITERIA	BOUCHON JOINT VIDANGE EMBASSE
3	REC304454	304454	CIERRE	LOCKWASHER	CHIUSURA	RONDELLE
4	CM434029	434029	ÁNODO	ANODE	ANODO	ANODE
5	REC316506	316506	BOLA	BALL	SFERA	BILLE
6	REC437288	437288	COJINETE (1994+)	BEARING (1994+)	CUSCINETTO (1994+)	ROULEMENT (1994+)
7	REC338518	338518	TÓRICA	O-RING	O-RING	JOINT TORIQUE
8	REC26-01674	332583	TÓRICA	O-RING	O-RING	JOINT TORIQUE
9	REC320041	320041	TORNILLO	SCREW	VITE	VIS
10	REC26-69188	321453	RETÉN ACEITE	OIL SEAL	PARAOLIO	JOINT SPI
11	REC323943	323943	ESPACIADOR HÉLICE	PROP SPACER	DISTANZIATORE ELICA	RONDELLE D'HELICE
12	REC320785	320785	PASADOR	COTTER PIN	CHIAVISTELLO	GOUPILLE FENDUE
13	REC319891	319891	TUERCA HÉLICE	PROP NUT	DADO ELICA	ÉCROU D'HELICE
14	REC321738	321738	JUNTA	GASKET	GUARNIZIONE	JOINT
15	REC301877	301877	ARO PARA REC393632	O-RING (FOR REC393632)	O-RING PER REC393632	JOINT TORIQUE POUR REC393632
16	REC303347	303347	TÓRICA	O-RING	O-RING	JOINT TORIQUE
17	REC321928	321928	RETÉN ACEITE	OIL SEAL	PARAOLIO	JOINT SPI
18	REC332261	332261	RETÉN ACEITE	OIL SEAL	PARAOLIO	JOINT SPI
19	REC325537	325537	JUNTA	GASKET	GUARNIZIONE	JOINT
20	REC328755	328755	TAPA BOMBA	WEAR PLATE	COPERCHIO POMPA	PLAQUE DE POMPE
21	REC328753	328753	RETÉN	SEAL	PARAOLIO	JOINT SPI
22	REC328754	328754	GRUESO PARA REC393632	BUSHING (FOR REC393632)	SPESSORE PER REC393632	CALE POUR REC393632
23	REC344470	344470	CHAVETA	KEY	CHIAVE	CLAVETTE
24	REC395289	395289	IMPULSOR	IMPELLER	GIRANTE	TURBINE
25	REC328751	328751	TAPA BOMBA	PUMP CUP	COPERCHIO POMPA	INSERT DE POMPE
26	REC0554545	554545	TÓRICA	O-RING	O-RING	JOINT TORIQUE
27	REC393632	393632	CUERPO BOMBA 2 CIL	PUMP HOUSING 2-CYL	CORPO POMPA 2 Cil	CORPS DE POMPE 2 CYL
28	REC302497	302497	GRUESO PARA REC393632	GROMMET (FOR REC393632)	SPESSORE PER REC393632	CALE POUR REC393632
29	REC340811	340811	GRUESO	GROMMET	SPESSORE	CALE
30	REC25-62705	311338	TÓRICA	O-RING	O-RING	JOINT TORIQUE



2T 40 - 50 HP 2 CYL LOOPCHARGED (1989-05)
 STROKES COLA PEQUEÑA | SMALL GEARCASE | PIEDE CORTO | EMBASE COURTE

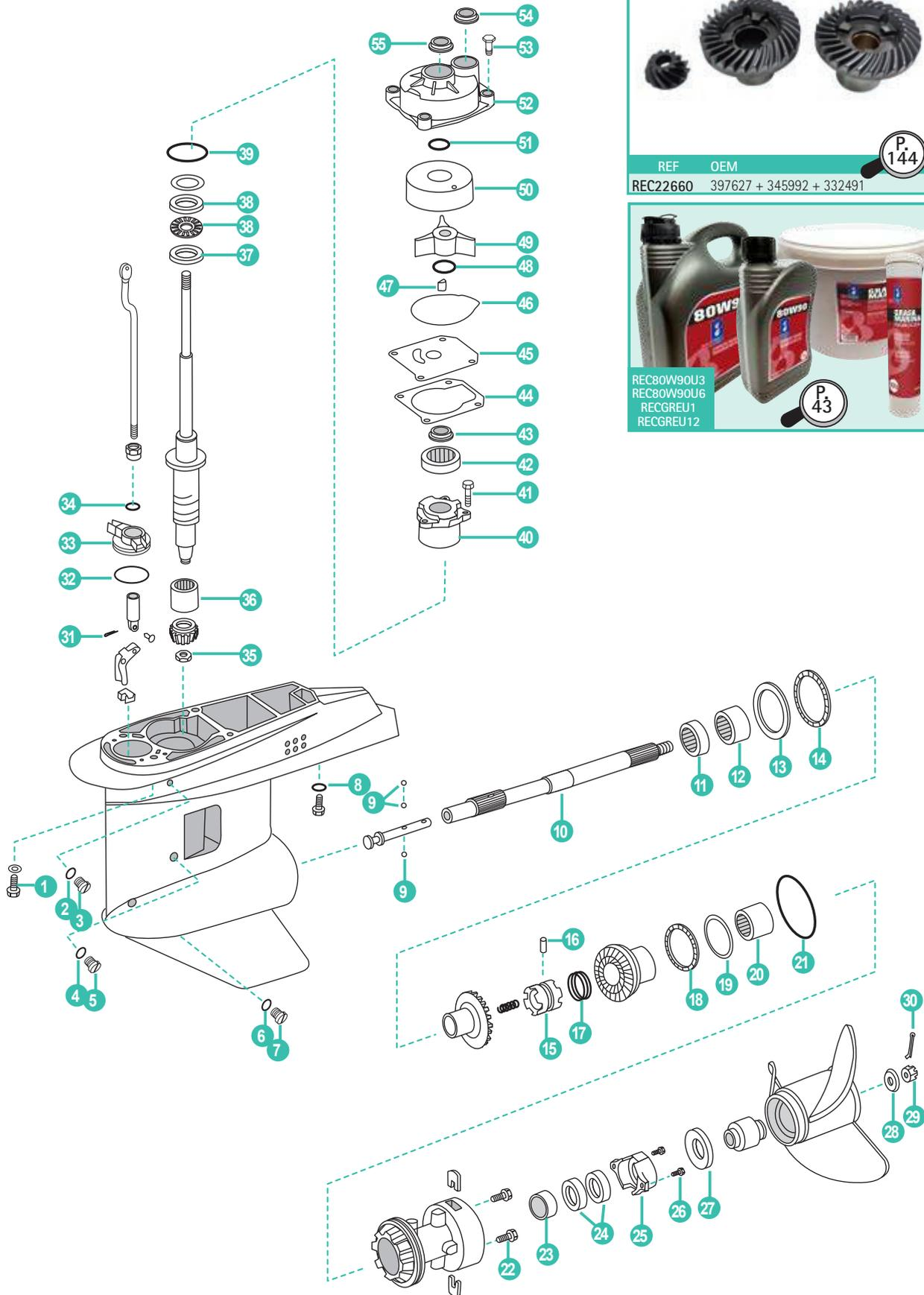

REF	OEM
REC22660	397627 + 345992 + 332491

P. 144



REC80W90U3
 REC80W90U6
 RECGREU1
 RECGREU12

P. 43

	REF	OEM				
1	REC305282	305282	TORNILLO	SCREW	VITE	VIS
2	REC336982	336982	TÓRICA	O-RING	O-RING	JOINT TORIQUE
3	REC309243	309243	TORNILLO	SCREW	VITE	VIS
4	REC332584	332584	RETÉN	SEAL OIL	PARAOLIO	JOINT SPI
5	REC324852	324852	TORNILLO	SCREW	VITE	VIS
6	REC3855081	311598	JUNTA	GASKET	GUARNIZIONE	JOINT
7	REC22-67892A05	318544	TORNILLO DRENAJE	DRAINING SCREW	VITE DRENAGGIO	VIS VIDANGE
8	REC330265	330265	ARANDELA	WASHER	RONDELLA	RONDELLE
9	REC316506	316506	BOLA	BALL	SFERA	BILLE
10	REC439138	439138	EJE HÉLICE	PROP SHAFT	ASSE ELICA	ARBRED'HÉLICE
11	REC432264	432264	COJINETE	BEARING	CUSCINETTO	ROULEMENT
12	REC382407	382407	COJINETE	BEARING	CUSCINETTO	ROULEMENT
13	REC333725	333725	ARANDELA	THRUST WASHER	RONDELLA	RONDELLE
14	REC397538	397538	ARANDELA COJINETE	THRUST BEARING	RONDELLA CUSCINETTO	RONDELLE CROULEMENT
15	REC332491	332491	SELECTOR	CLUTCH DOG	SELETTORE	CRABOT
16	REC320310	320310	PASADOR	CROSS PIN	CHIAVISTELLO	PIN
17	REC320311	320311	MUELLE	SPRING	MOLLA	RESSORT
18	REC397537	397537	ARANDELA COJINETE	THRUST BEARING	RONDELLA CUSCINETTO	RONDELLE ROULEMENT
19	REC332514	332514	ARANDELA	THRUST WASHER	RONDELLA	RONDELLE
20	REC386764	386764	COJINETE	BEARING	CUSCINETTO	ROULEMENT
21	REC553126	553126	TÓRICA	O-RING	O-RING	JOINT TORIQUE
22	REC328744	328744	TORNILLO	SCREW	VITE	VIS
23	REC386765	386765	COJINETE	BEARING	CUSCINETTO	ROULEMENT
24	REC321467	321467	RETÉN ACEITE	OIL SEAL	PARAOLIO	JOINT SPI
25	CM398873 CM398873A	398873 398873	ÁNODO ÁNODO ALUMINIO	ANODE ALUMINUM ANODE	ANODO ANODO ALLUMINIO	ANODE ANODE AL
26	REC328694	328694	TORNILLO	SCREW	VITE	VIS
27	REC320305	320305	ARANDELA	THRUST WASHER	RONDELLA	RONDELLE
28	REC315810	315810	ESPACIADOR HÉLICE	PROP SPACER	DISTANZIATORE ELICA	RONDELLE BUTEE D'HELICE
29	REC314503	314503	TUERCA HÉLICE	PROP NUT	DADO ELICA	ECROU D'HELICE
30	REC314502	314502	PASADOR	COTTER PIN	CHIAVISTELLO	GOUPILLE
31	REC306376	306376	PASADOR	COTTER PIN	CHIAVISTELLO	GOUPILLE
32	REC3852928	913921	TÓRICA	O-RING	O-RING	JOINT TORIQUE
33	REC434588	434588	TAPA ACOPLAMIENTO	COVER & BUSHING ASSEMBLY	COPERCHIO ACCOPPIAMENTO	COUVERCLE
34	REC318372	318372	TÓRICA	O-RING	O-RING	JOINT TORIQUE
35	REC313339	313339	TUERCA PIÑÓN	PINION NUT	DADO PIGNONE	ECROU
36	REC382343	382343	COJINETE	BEARING	CUSCINETTO	ROULEMENT
37	REC333771	333771	ARANDELA	THRUST WASHER	RONDELLA	RONDELLE
38	REC398901	398901	ARANDELA COJINETE	THRUST BEARING	RONDELLA CUSCINETTO	RONDELLE ROULEMENT
39	REC25-30224	310327	TÓRICA	O-RING	O-RING	JOINT TORIQUE
40	REC435274	435274	CUERPO COJINTE	BEARING HOUSING ASSEMBLY	CORPO CUSCINETTO	PALLIER DE ROULEMENT
41	REC317624	317624	TORNILLO	SCREW	VITE	VIS
42	REC398874	398874	COJINETE	BEARING	CUSCINETTO	ROULEMENT
43	REC342786	342786	RETÉN ACEITE	OIL SEAL	PARAOLIO	JOINT SPI
44	REC336530	336530	JUNTA	GASKET	GUARNIZIONE	JOINT
45	REC341038	341038	TAPA	WEAR PLATE	COPERCHIO	COUVERCLE
46	REC324981	324981	RETÉN	SEAL	TENUTA	JOINT
47	REC334897	334897	CHAVETA	KEY	CHIAVE	CLAVETTE
48	REC331188	331188	TÓRICA	O-RING	O-RING	JOINT TORIQUE
49	REC432941	432941	IMPULSOR (1989-02)	IMPELLER (1989-02)	GIRANTE (1989-02)	TURBINE (1989-02)
50	REC340619	340619	TAPA BOMBA	PUMP CUP	COPERCHIO POMPA	INSERT DE POMPE
51	REC310584	310584	TÓRICA	O-RING	O-RING	JOINT TORIQUE
52	REC438544	438544	CUERPO BOMBA (1989-98)	PUMP HOUSING (1989-98)	CORPO POMPA (1989-98)	CORPS DE POMPE (1989-98)
53	REC302325	302325	TORNILLO	SCREW	VITE	VIS
54	REC333758	333758	GRUESO	GROMMET	SPESSORE	CALE
55	REC341732	341732	GRUESO	GROMMET	SPESSORE	CALE

2T 40 - 60 HP 2 CYL LOOPCHARGED (1975-88) • 60 - 75 HP 2 CYL LOOPCHARGED (1975-88)
 STROKES COLA PEQUEÑA | SMALL GEARCASE | PIEDE CORTO | EMBASE COURTE

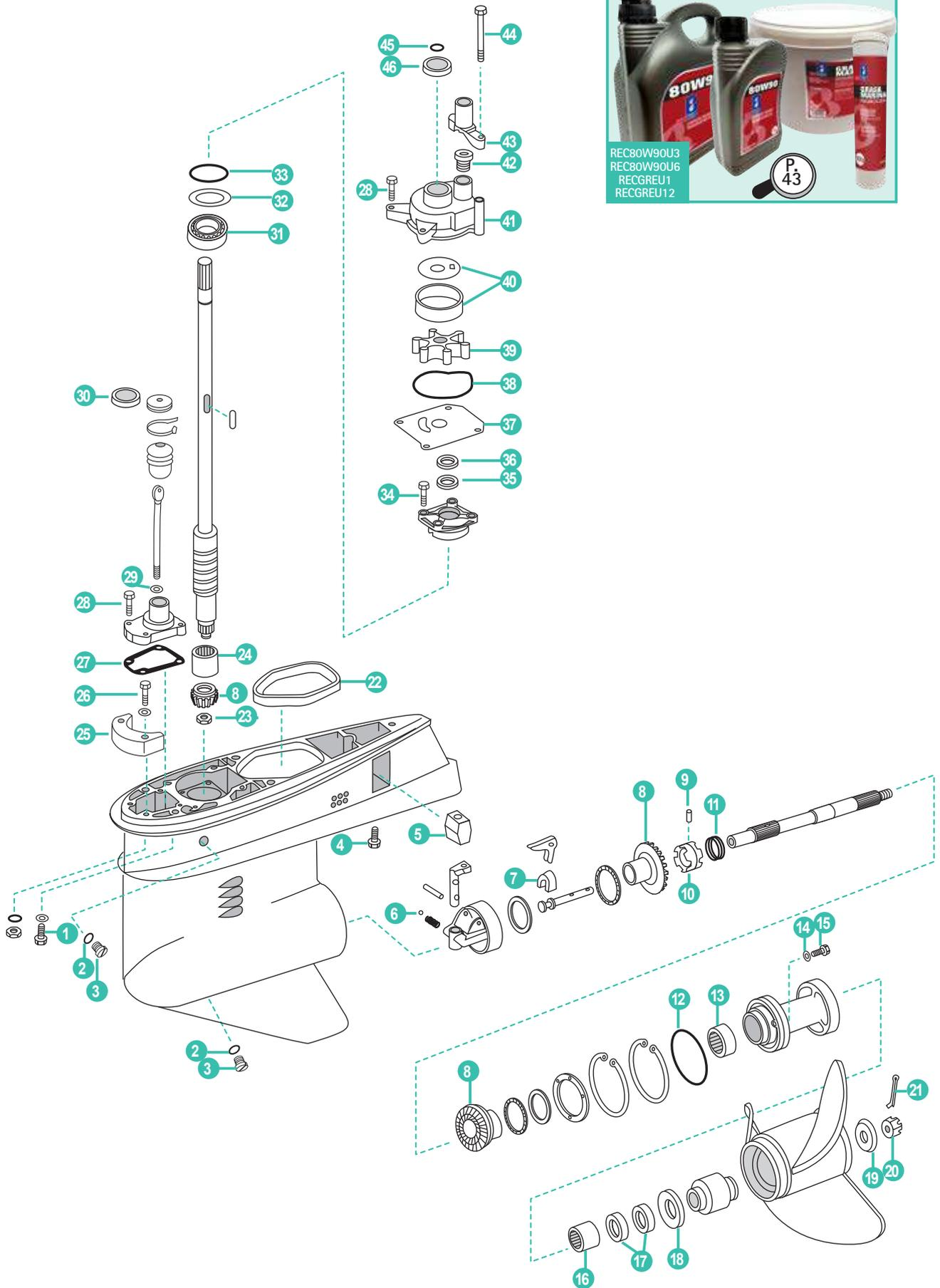

	REF	OEM				
1	REC305282	305282	TORNILLO	SCREW	VITE	VIS
2	REC3855081	311598	JUNTA	GASKET	GUARNIZIONE	JOINT
3	REC10-79953Q04	307551	TORNILLO	SCREW	VITE	VIS
4	REC328096	328096	TORNILLO	SCREW	VITE	VIS
5	REC436745AL	436745	ÁNODO	ANODE	ANODO	ANODE
6	REC160084	160084	BOLA	DETENT BALL	SFERE	BILLE
7	REC334163	334163	REGULADOR EJE	CRADLE	REGOLATORE ASSE	REGULATEUR D'AXE
8	REC433570	433570	KIT PIÑONES	GEAR SET	KIT PIGNONI	KIT PIGNON
9	REC320310	320310	PASADOR	CROSS PIN	CHIAVISTELLO	PIN
10	REC319895	319895	SELECTOR	CLUTCH DOG	SELETTORE	CRABOT
11	REC320311	320311	MUELLE	SPRING	MOLLA	RESSORT
12	REC925093	320303	TÓRICA	O-RING	O-RING	JOINT TORIQUE
13	REC386764	386764	COJINETE	BEARING	CUSCINETTO	ROULEMENT
14	REC332584	332584	TÓRICA	O-RING	O-RING	JOINT TORIQUE
15	REC320041	320041	TORNILLO	SCREW	VITE	VIS
16	REC386765	386765	COJINETE	BEARING	CUSCINETTO	ROULEMENT
17	REC321467	321467	RETÉN ACEITE	OIL SEAL	PARAOLIO	JOINT SPI
18	REC320305	320305	ARANDELA	THRUST WASHER	RONDELLA	RONDELLE
19	REC315810	315810	ESPACIADOR HÉLICE	PROP SPACER	DISTANZIATORE ELICA	RONDELLE BUTEE D'HELICE
20	REC314503	314503	TUERCA HÉLICE	PROP NUT	DADO ELICA	ECROU D'HELICE
21	REC314502	314502	PASADOR	COTTER PIN	CHIAVISTELLO	GROUPELLE FENDUE
22	REC324937	324937	RETÉN	SEAL	TENUTA	JOINT
23	REC313339	313339	TUERCA PIÑÓN	PINION NUT	DADO PIGNONE	ECROU
24	REC386766	386766	PIÑÓN COJINETE	PINION BEARING	PIGNONE CUSCINETTO	PIGNON ROULEMENT
25	CM392462	392462	ÁNODO	ANODE	ANODO	ANODE
26	REC331980	324430	TORNILLO	SCREW	VITE	VIS
27	REC314082	314082	JUNTA	GASKET	GUARNIZIONE	JOINT
28	REC302325	302325	TORNILLO	SCREW	VITE	VIS
29	REC318372	318372	TÓRICA	O-RING	O-RING	JOINT TORIQUE
30	REC305762	305762	GRUESO	GROMMET	SPESSORE	CALE
31	REC31-32575T1	385175	COJINETE	BEARING	CUSCINETTO	ROULEMENT
32	REC320166	320166	SUPLEMENTO .003	SHIM .003	SPESSORE .003	CALE .003
32	REC320167	320167	SUPLEMENTO .004	SHIM .004	SPESSORE .004	CALE .004
32	REC320168	320168	SUPLEMENTO .005	SHIM .005	SPESSORE .005	CALE .005
33	REC302588	302588	TÓRICA	O-RING	O-RING	JOINT TORIQUE
34	REC909386	909386	TORNILLO	SCREW	VITE	VIS
35	REC342786	321466	RETÉN ACEITE	OIL SEAL	PARAOLIO	JOINT SPI
36	REC342786	332205	RETÉN ACEITE	OIL SEAL	PARAOLIO	JOINT SPI
37	REC320981	320981	TAPA	WEAR PLATE	COPERCHIO	COUVERCLE
38	REC315788	315788	RETÉN	SEAL	TENUTA	JOINT
39	REC777214	396809	IMPULSOR (1979-88)	IMPELLER (1979-88)	GIRANTE (1979-88)	TURBINE (1979-88)
39	REC331901	331901	CHAVETA BLANCA (1979-88)	KEY, WHITE (1979-88)	CHIAVE, BIANCO (1979-88)	CLAVETTE, BLANCHE (1979-88)
39	REC344470	344470	CHAVETA NEGRA (1979-88)	KEY, BLACK (1979-88)	CHIAVE, NERO (1979-88)	CLAVETTE NOIRE (1979-88)
39	REC777213	377230	IMPULSOR (1975-78)	IMPELLER (1975-78)	GIRANTE (1975-78)	TURBINE (1975-78)
39	REC308928	308928	CHAVETA (1975-78)	KEY (1975-78)	CHIAVE (1975-78)	CLAVETTE (1975-78)
40	REC320775	320775-6	TAPA BOMBA	PUMP CUP	COPERCHIO POMPA	INSERT DE POMPE
41	REC384087	384087	CUERPO BOMBA	PUMP HOUSING	CORPO POMPA	CORPS DE POMPE
42	REC315837	315837	GRUESO	GROMMET	SPESSORE	CALE
43	REC315838	315838	TUBO GUÍA	TUBE GUIDE	TUBO GUIDA	TUBE GUIDE
44	REC331980	331980	TORNILLO	SCREW	VITE	VIS
45	REC339543	303059	TÓRICA	O-RING	O-RING	JOINT TORIQUE
46	REC341732	341732	GRUESO	GROMMET	SPESSORE	CALE

2T 40 - 60 HP 2 CYL LOOPCHARGED (1975-06) • 60 - 75 HP 2 CYL LOOPCHARGED (1975-01)

STROKES COLA LARGA | LARGE GEARCASE | PIEDE LUNGO | EMBASE LONGUE

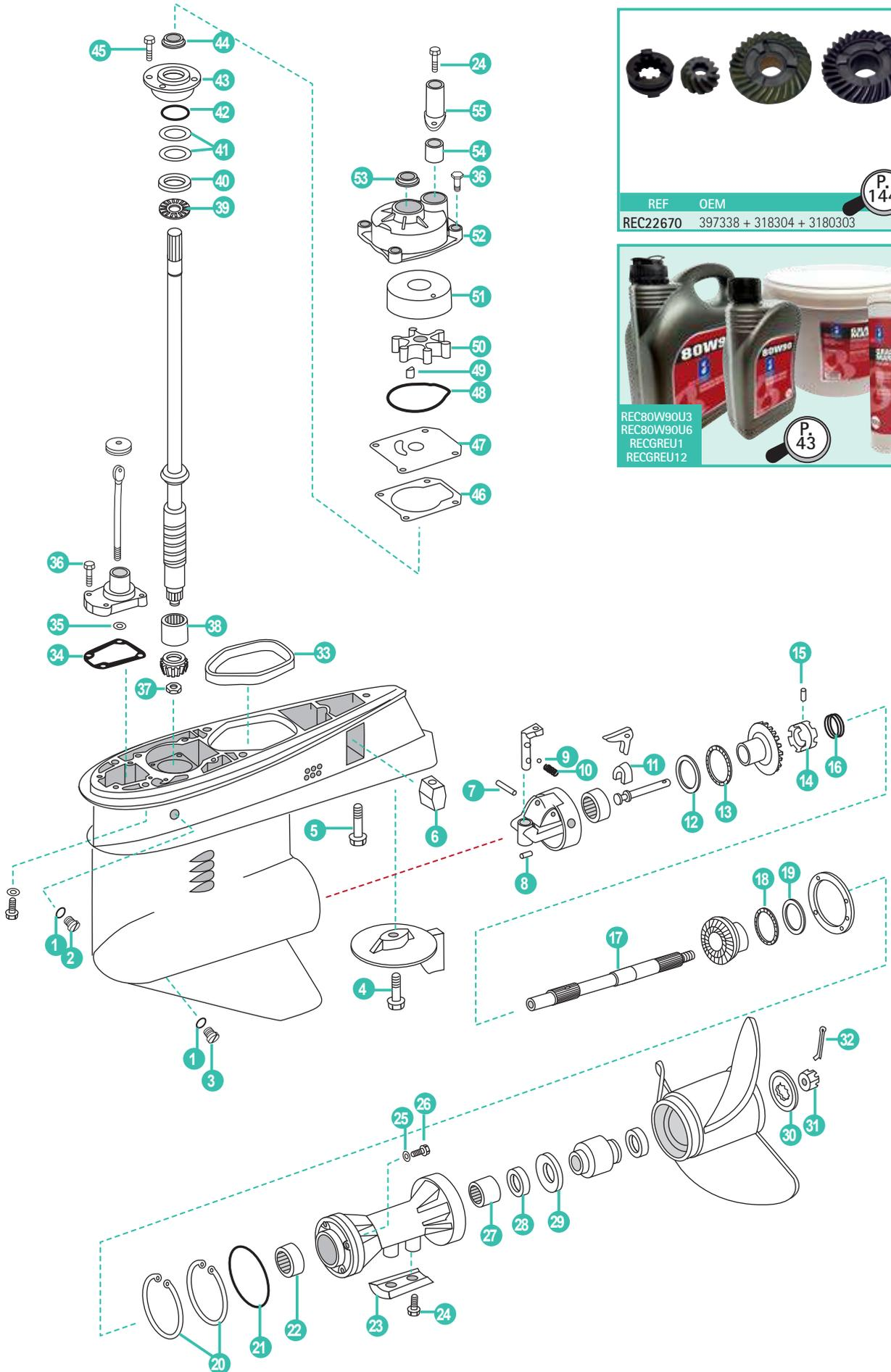

	REF	OEM				
1	REC12-191833	311598	JUNTA	GASKET	GUARNIZIONE	JOINT
2	REC10-79953Q04	307551	TORNILLO	SCREW	VITE	VIS
3	REC22-67892A05	318544	TORNILLO DRENAJE	DRAINING SCREW	VITE DRENAGGIO	VIS VIDANGE
4	REC313715	313715	TORNILLO	SCREW	VITE	VIS
5	REC328096	328096	TORNILLO	SCREW	VITE	VIS
6	REC436745AL	436745	ANODO	ANODE	ANODO	ANODE
7	REC320145	320145	PASADOR	PIN	CHIAVISTELLO	PIN
8	REC331880	331880	PASADOR	PIN	CHIAVISTELLO	PIN
9	REC327345	327345	BOLA	DETENT BALL	SFERA	BILLE
10	REC911961	911961	MUELLE	SPRING	MOLLA	RESSOR
11	REC334163	334163	REGULADOR EJE	CRADLE	REGOLATORE ASSE	REGULATEUR D'AXE
12	REC324766	324766	ARANDELA	THRUST WASHER	RONDELLA	RONDELLE
13	REC385043	385043	ARANDELA COJINETE	THRUST BEARING	RONDELLA CUSCINETTO	RONDELLE ROULEMENT
14	REC318303	318303	SELECTOR	CLUTCH DOG	SELETTORE	CRABOT
15	REC313448	313448	PASADOR	CROSS PIN	CHIAVISTELLO	GROUPELLE FENDUE
16	REC324369	324369	MUELLE	SPRING	MOLLA	RESSORT
17	REC439185	439185	EJE HÉLICE	PROP SHAFT	ASSE ELICA	ARBRE D'HÉLICE
18	REC382408	382408	ARANDELA COJINETE	THRUST BEARING	RONDELLA CUSCINETTO	RONDELLE ROULEMENT
19	REC313447	313447	ARANDELA	THRUST WASHER	RONDELLA	RONDELLE
20	REC313445	313445	ARO RETENEDOR	RETAINING RING	ANELLO RITENITORE	RONDELLE DE RETENUE
21	REC967344	313446	TÓRICA	O-RING	O-RING	JOINT TORIQUE
22	REC382407	382407	COJINETE	BEARING	CUSCINETTO	ROULEMENT
23	CM431708	431708	ANODO	ANODE	ANODO	ANODE
24	REC908158	908158	TORNILLO	SCREW	VITE	VIS
25	REC3852045	332584	TÓRICA	O-RING	O-RING	JOINT TORIQUE
26	REC320041	320041	TORNILLO	SCREW	VITE	VIS
27	REC379504	379504	COJINETE	BEARING	CUSCINETTO	ROULEMENT
28	REC330137	330137	RETÉN ACEITE	OIL SEAL	PARAOLIO	JOINT SPI
29	REC127084	127084	ARANDELA	THRUST WASHER	RONDELLA	RONDELLE
30	REC315810	315810	ESPACIADOR HÉLICE	PROP SPACER	SPESSORE ELICA	RONDELLE BUTEE D'HELICE
31	REC314503	314503	TUERCA HÉLICE	PROP NUT	DADO ELICA	ÉCROU D'HÉLICE
32	REC314502	314502	PASADOR	COTTER PIN	CHIAVISTELLO	PIN
33	REC324937	324937	RETÉN	SEAL	TENUTA	JOINT SPI
34	REC314082	314082	JUNTA	GASKET	GUARNIZIONE	JOINT
35	REC318372	318372	TÓRICA	O-RING	O-RING	JOINT TORIQUE
36	REC302325	302325	TORNILLO	SCREW	VITE	VIS
37	REC313339	313339	TUERCA PIÑÓN	PINION NUT	DADO PIGNONE	ÉCROU
38	REC382343	382343	COJINETE	BEARING	CUSCINETTO	ROULEMENT
39	REC385068	385068	ARANDELA COJINETE	THRUST BEARING	RONDELLA CUSCINETTO	RONDELLE ROULEMENT
40	REC317230	317230	ARANDELA	THRUST WASHER	RONDELLA	RONDELLE
41	REC323889	323889	SUPLEMENTO .003	SHIM .003	SUPPLEMENTO .003	CALE .003
	REC323890	323890	SUPLEMENTO .004	SHIM .004	SUPPLEMENTO .004	CALE .004
	REC317232	317232	SUPLEMENTO .005	SHIM .005	SUPPLEMENTO .005	CALE .005
42	REC313754	313754	TÓRICA	O-RING	O-RING	JOINT TORIQUE
43	REC385087	385087	CUERPO COJINETE Y RETÉN	BEARING HOUSING & SEAL	CORPO CUSCINETTO E PARAOLIO	LOGEMENT JOINT SPI
	REC435519	435519	CUERPO COJINETE Y RETÉN	BEARING HOUSING & SEAL	CORPO CUSCINETTO E PARAOLIO	LOGEMENT JOINT SPI
44	REC342786	342786	RETÉN ACEITE	OIL SEAL	PARAOLIO	JOINT SPI
45	REC909386	909386	TORNILLO	SCREW	VITE	VIS
46	REC336530	336530	JUNTA	GASKET	GUARNIZIONE	JOINT
47	REC341038	341038	TAPA	WEAR PLATE	COPERCHIO	COUVERCLE
48	REC319586	319586	JUNTA (1975-78)	GASKET (1975-78)	GUARNIZIONE (1975-78)	JOINT (1975-78)
	REC324981	324981	RETÉN (1979-06)	SEAL (1979-06)	TENUTA (1979-06)	JOINT SPI (1975-78)
	REC308928	308928	CHAVETA (1975-78)	KEY (1975-78)	CHIAVE (1975-78)	CLAVETTE (1975-78)
	REC331901	331901	CHAVETA BLANCA (1979-06)	KEY, WHITE (1979-06)	CHIAVE, BIANCO (1979-06)	CLAVETTE BLANCHE (1979-06)
	REC334897	334897	CHAVETA NEGRA (1979-06)	KEY, BLACK (1979-06)	CHIAVE, NERO (1979-06)	CLAVETTE NOIRE (1979-06)
50	REC765431	382547	IMPULSOR (1975-78)	IMPELLER (1975-78)	GIRANTE (1975-78)	TURBINE (1975-78)
	REC396725	396725	IMPULSOR (1979-06)	IMPELLER (1979-06)	GIRANTE (1979-06)	TURBINE (1979-06)
51	REC340619	340619	TAPA BOMBA	PUMP CUP	COPERCHIO POMPA	INSERT DE POMPE
52	REC438543	438543	CUERPO BOMBA	PUMP HOUSING	CORPO POMPA	CORPS DE POMPE
53	REC341732	341732	GRUESO	GROMMET	SPESSORE	CALE
54	REC314008	314008	GRUESO	GROMMET	SPESSORE	CALE
55	REC319276	319276	TUBO GUÍA	TUBE GUIDE	TUBO GUIDA	TUBE GUIDE

2T V4 60° (1995-06) RATIO 2.00:1 (.50)
STROKES

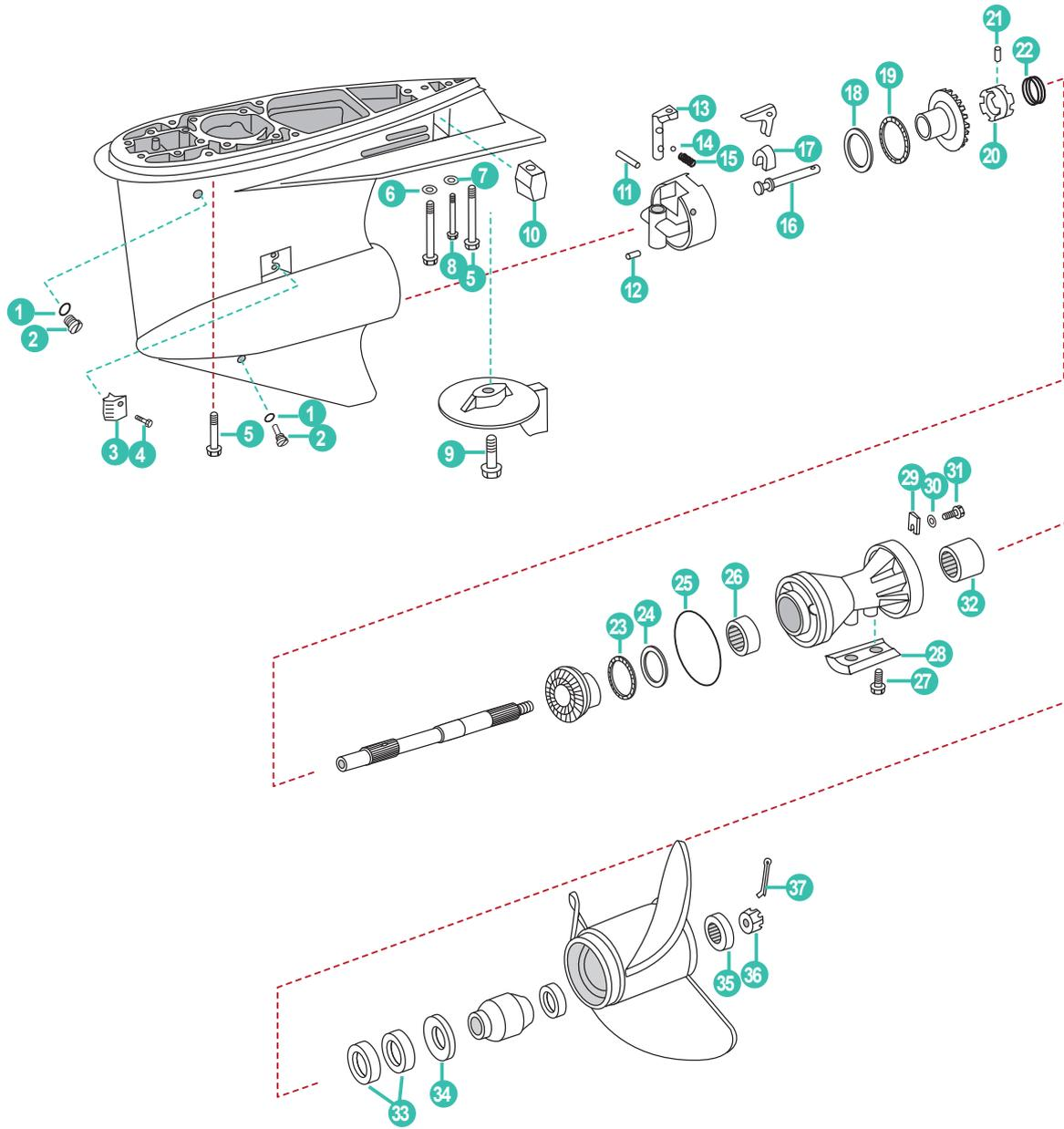

	REF	OEM				
1	REC3855081	311598	JUNTA	GASKET	GUARNIZIONE	JOINT DE VIDANGE
2	REC22-67892A05	318544	TORNILLO DRENAJE	DRAINING SCREW	VITE DRENAGGIO	VIS DE VIDANGE
3	REC337778	337778	REJILLA	SCREEN	VITE	VIS
4	REC337061	337061	TORNILLO	SCREW	VITE	VIS
5	REC331999	331999	TORNILLO	SCREW	VITE	VIS
6	REC330265	330265	ARANDELA	WASHER	RONDELLA	RONDELLE
7	REC307161	307161	CIERRE	LOCKWASHER	CHIUSURA	RONDELLE GROWER
8	REC341219	341219	TORNILLO	SCREW	VITE	VIS
9	REC313763	313715	TORNILLO	SCREW	VITE	VIS
10	REC436745AL	436745	ÁNODO	ANODE	ANODO	ANODE
11	REC320145	320145	PASADOR	PIN	CHIAVISTELLO	PIN
12	REC323664	331880	PASADOR	PIN	CHIAVISTELLO	PIN
13	REC915954	915954	EJE VARILLA CAMBIO	DETENT	ASSE BACCHETTA CAMBIO	ARBRE CHANGEMENT DE VITESSE
14	REC911961	911961	MUELLE	SPRING	MOLLA	RESSORT
15	REC327345	327345	BOLA	DETENT BALL	SFERE	BILLE
16	REC322941	322941	EJE	SHAFT	ASSE	ARBRE
17	REC334163	334163	REGULADOR EJE	CRADLE	REGOLATORE ASSE	REGULATEUR D'AXE
18	REC324766	324766	ARANDELA	THRUST WASHER	RONDELLA	RONDELLE
19	REC385043	385043	ARANDELA COJINETE	THRUST BEARING	RONDELLA CUSCINETTO	RONDELLE ROULEMENT
20	REC323664	323664	SELECTOR	CLUTCH DOG	SELETTORE	CRABOT
21	REC313448	313448	PASADOR	PIN	CHIAVISTELLO	PIN
22	REC324369	324369	MUELLE	SPRING	MOLLA	RESSORT
23	REC382408	382408	ARANDELA COJINETE	THRUST BEARING	RONDELLA CUSCINETTO	RONDELLE ROULEMENT
24	REC314731	314731	ARANDELA	THRUST WASHER	RONDELLA	RONDELLE
25	REC967344	313446	TÓRICA	O-RING	O-RING	JOINT TORIQUE
26	REC382407	382407	COJINETE	BEARING	CUSCINETTO	ROULEMENT
27	REC908158	908158	TORNILLO	SCREW	VITE	VIS
28	CM431708	431708	ÁNODO	ANODE	ANODO	ANODE
29	REC333957	333957	PESTAÑA SUJECCIÓN	TAB	LEVA DI SOSTEGNO	BAGUE DE RETENUE
30	REC328743	328743	ARANDELA	WASHER	RONDELLA	RONDELLE
31	REC350271	350271	TORNILLO	SCREW	VITE	VIS
32	REC379504	379504	COJINETE	BEARING	CUSCINETTO	ROULEMENT
33	REC330137	330137	RETÉN ACEITE	OIL SEAL	PARAOILIO	JOINT SPI
34	REC127084	127084	ARANDELA 3 PALAS	THRUST WASHER (3-BLADE)	RONDELLA 3 PALE	RONDELLE 3 PALES
35	REC315810	315810	ESPACIADOR	SPACER	DISTANZIATORE	RONDELLE BUTEE D'HELICE
36	REC314503	314503	TUERCA HÉLICE	PROP NUT	DADO ELICA	ECROU D'HELICE
37	REC314502	314502	PASADOR	COTTER PIN	CHIAVISTELLO	PIN

2T V4 60° (1995-06) RATIO 2.00:1 (.50)
STROKES

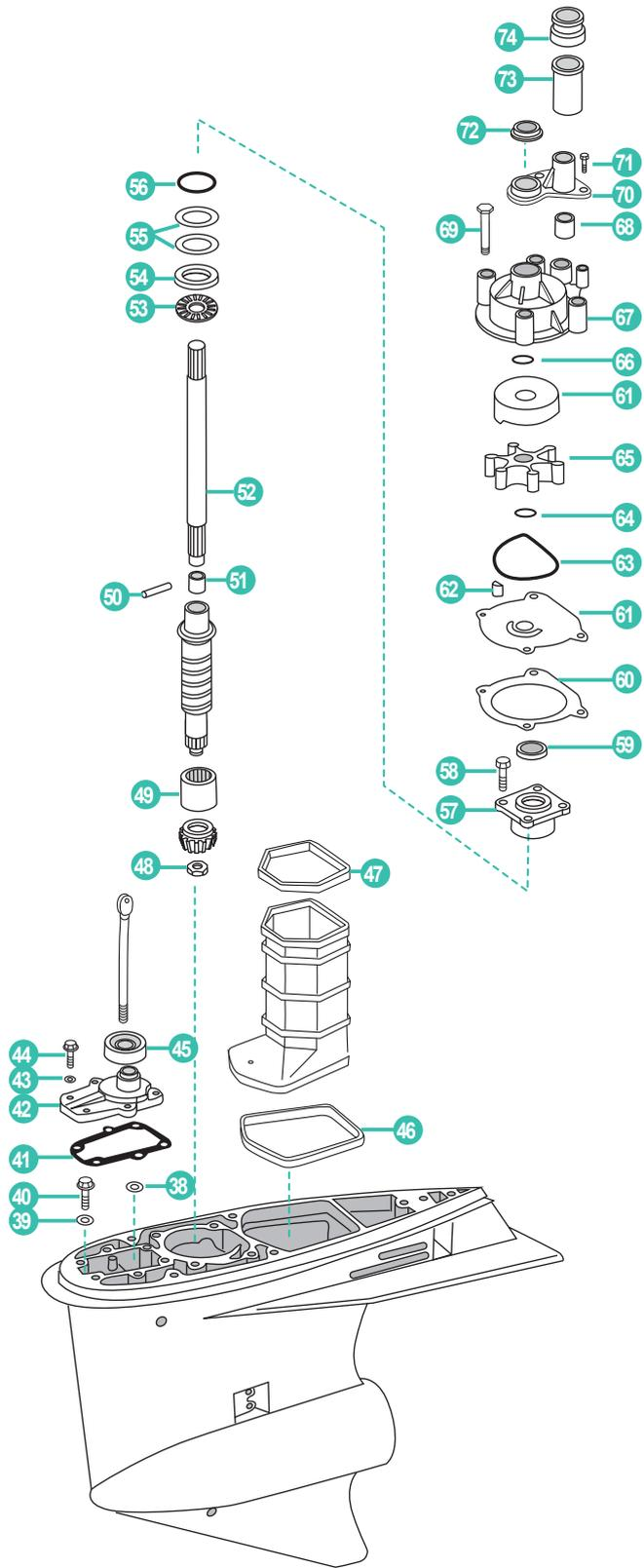

	REF	OEM				
38	REC318372	318372	TÓRICA	O-RING	O-RING	JOINT TORIQUE
39	REC437330	437330	ARANDELA CIERRE	SEAL WASHER	RONDELLA CHIUSURA	RONDELLE
40	REC341220	341220	TORNILLO	SCREW	VITE	VIS
41	REC324670	324670	JUNTA	GASKET	GUARNIZIONE	JOINT
42	REC5006241	5006241	TAPA Y RETÉN	COVER & SEAL ASSEMBLY	COPERCHIO E PARAOLIO	PLAQUE AVEC JOINT SPI
43	REC328702	328702	ARANDELA	WASHER	RONDELLA	RONDELLE
44	REC302325	302325	TORNILLO	SCREW	VITE	VIS
45	REC321008	321008	GRUESO	GROMMET	SPESSORE	CALE
46	REC320961	320961	RETÉN	SEAL	TENUTA	JOINT
47	REC320936	320936	RETÉN	SEAL	TENUTA	JOINT
48	REC11-35921	314730	TUERCA	NUT	DADO	ÉCROU
49	REC384195	384195	PIÑÓN COJINETE	PINION BEARING	PIGNONE CUSCINETTO	ROULEMENT À AIGUILLES
50	REC311538	311538	PASADOR	PIN	CHIAVISTELLO	PIN
51	REC338504	338504	RETENEDOR	RETAINER	FERMO	RETENUE
52	REC5000615	5000615	EJE COLA	DRIVE SHAFT	ASSE PIEDE	ARBRE EMBASE
53	REC387656	387656	ARANDELA COJINETE	THRUST BEARING	RONDELLA CUSCINETTO	RONDELLE ROULEMENT
54	REC327656	327656	ARANDELA	THRUST WASHER	RONDELLA	RONDELLE
55	REC323362	323362	SUPLEMENTO .003	SHIM .003	SPESSORE .003	CALE .003
	REC323361	323361	SUPLEMENTO .004	SHIM .004	SPESSORE .004	CALE .004
	REC314745	314745	SUPLEMENTO .005	SHIM .005	SPESSORE .005	CALE .005
56	REC314728	314728	TÓRICA	O-RING	O-RING	JOINT TORIQUE
57	REC439476	439476	CUERPO COJINETE Y RETÉN	BEARING HOUSING & SEAL	CORPO CUSCINETTO E PARAOLIO	PALLIER DE ROULEMENT ET JOINT SPI
58	REC317624	317624	TORNILLO	SCREW	VITE	VIS
59	REC341280	341280	RETÉN ACEITE	OIL SEAL	PARAOLIO	JOINT SPI
60	REC338484	338484	JUNTA	GASKET	GUARNIZIONE	JOINT
61	REC435027	435027	TAPA Y PLATO	CUP & PLATE ASSEMBLY	COPERCHIO E PIATTO	INSERT DE POMPE
62	REC331107	331107	CHAVETA	KEY	CHIAVE	CLAVETTE
63	REC331353	331353	RETÉN	SEAL	TENUTA	JOINT SPI
64	REC302035	302035	TÓRICA	O-RING	O-RING	JOINT TORIQUE
65	REC5001593	435821	IMPULSOR	IMPELLER	GIRANTE	TURBINE
66	REC331188	331188	TÓRICA	O-RING	O-RING	JOINT TORIQUE
67	REC5007968	435959	CUERPO BOMBA (TRANSOM 25")	PUMP HOUSING (25 TRANSOM)	CORPO POMPA (TRANSOM 25")	CORPS DE POMPE (TRANSOM 25")
	REC435990	435990	CUERPO BOMBA (TRANSOM 20")	PUMP HOUSING (20 TRANSOM)	CORPO POMPA (TRANSOM 20")	CORPS DE POMPE (TRANSOM 20")
68	REC314008	314008	GRUESO	GROMMET	SPESSORE	CALE
69	REC302325	302325	TORNILLO	SCREW	VITE	VIS
70	REC338893	338893	TUBO GUÍA	TUBE GUIDE	TUBO GUIDA	TUBE GUIDE
71	REC306643	306643	TORNILLO	SCREW	VITE	VIS
72	REC320943	320943	GRUESO	GROMMET	SPESSORE	CALE
73	REC338636	338636	TUBO ESPACIADOR CORTO	TUBE SPACER (SHORT)	TUBO DISTANZIATORE CORTO	TUBE GUIDE
74	REC354580	338601	GRUESO	GROMMET	SPESSORE	CALE

2T V4 / V6 "0" (1979-06) RATIO V4 2.25:1 (.44), V6 1.86:1 (.54)
STROKES

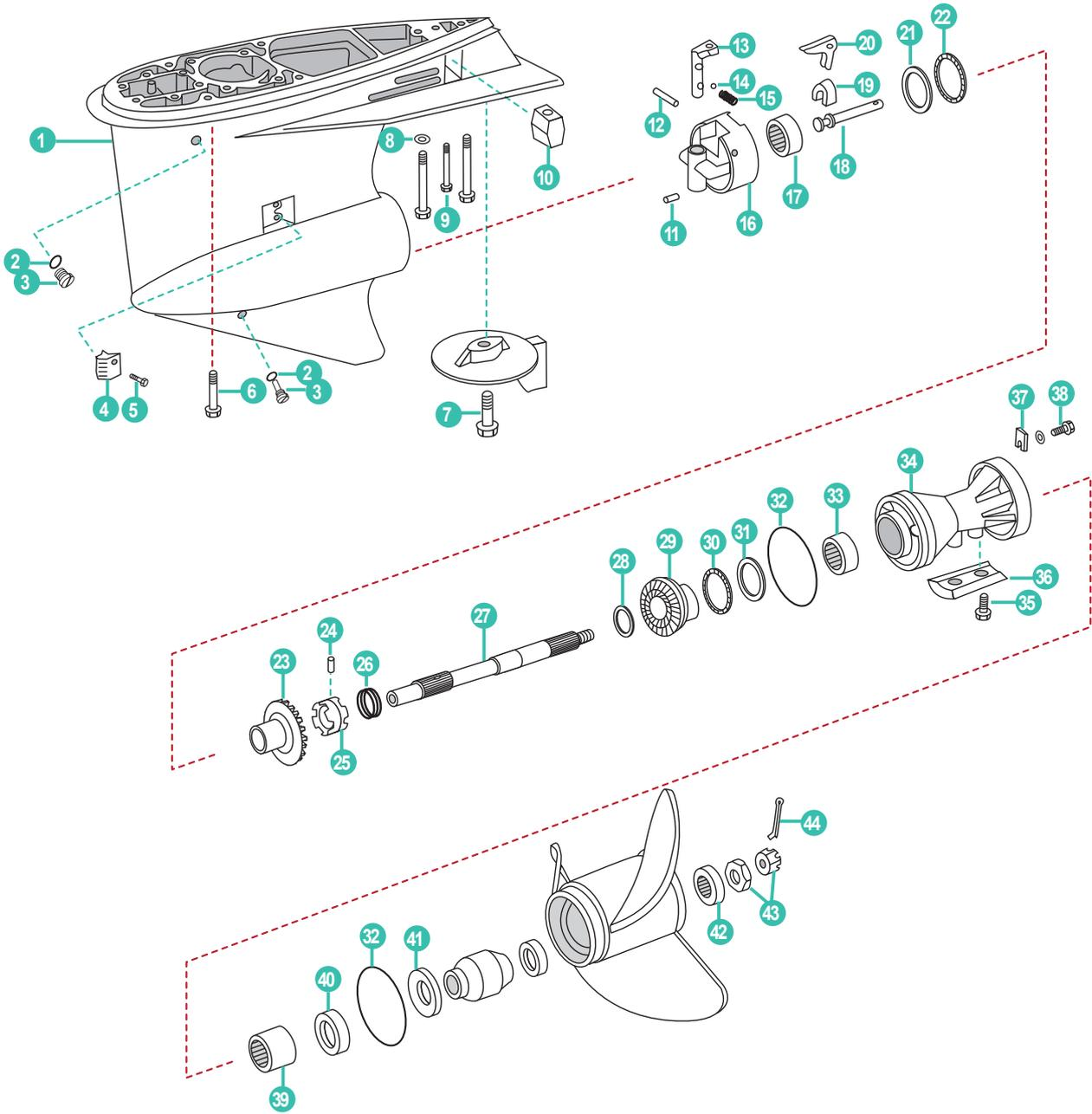

	REF	OEM				
1	REC439973 REC5007022	439973 439972	CARCASA COLA Y TUBO CARCASA COLA	GEARCASE ASSEMBLY / TUBE GEARCASE ASSEMBLY	CARCASSA PIEDE E TUBO CARCASSA PIEDE	EMBASE EMBASE COMPLET
2	REC3855081	311598	JUNTA	GASKET	GUARNIZIONE	JOINT
3	REC22- 67892A05	318544	TORNILLO DRENAJE	DRAINING SCREW	VITE DRENAGGIO	VIS VIDANGE
4	REC337778	337778	REJILLA	SCREEN	GRIGLIA	GRILLE
5	REC337061	337061	TORNILLO	SCREW	VITE	VIS
6	REC331999	331999	TORNILLO	SCREW	VITE	VIS
7	REC313715	313715	TORNILLO	SCREW	VITE	VIS
8	REC330265	330265	ARANDELA	WASHER	RONDELLA	RONDELLE
9	REC328096	328096	TORNILLO	SCREW	VITE	VIS
10	REC436745AL	436745	ÁNODO	ANODE	ANODO	ANODE
11	REC331880	331880	PASADOR	PIN	CHIAVISTELLO	PIN
12	REC328825	328825	PASADOR	PIN	CHIAVISTELLO	PIN
13	REC915954	915954	EJE VARILLA CAMBIO	DETENT	ASSE BACCHETTA CAMBIO	ARBRE CHANGEMENT DE VITESSE
14	REC160084	160084	BOLA	DETENT BALL	SFERA	BILLE
15	REC911962	911962	MUELLE	SPRING	MOLLA	RESSORT
16	REC389455	389455	CUERPO Y COJINETE	HOUSING & BEARING ASSEMBLY	CORPO E CUSCINETTO	PALIER DE ROULEMENT
17	REC389039	389039	COJINETE	BEARING	RONDELLA	ROULEMENT
18	REC322941	322941	EJE	SHAFT	ASSE	ARBRE
19	REC334163	334163	REGULADOR EJE	CRADLE	REGOLATORE ASSE	REGULATEUR D'AXE
20	REC322938	322938	ELEVADOR	LEVER	LEVA	CROCHET
21	REC327669	327669	ARANDELA	THRUST WASHER	RONDELLA	RONDELLE
22	REC389042	389042	ARANDELA COJINETE	THRUST BEARING	RONDELLA CUSCINETTO	RONDELLE ROULEMENT
23	REC435123	435123	KIT PIÑONES MARCHA AVANTE V4	P / FORWARD GEAR SET V4	KIT PIGNONE MARCIA AVANTI V4	KIT PIGNON MARCHE AV ET ATTAQUE
24	REC313448	313448	PASADOR	CROSS PIN	CHIAVISTELLO	GROUPILLE
25	REC337774	337774	SELECTOR	CLUTCH DOG	SELETTORE	CRABOT
26	REC324369	324369	MUELLE	SPRING	MOLLA	RESSORT
27	REC395209 REC5004765	395209 5004765	EJE HÉLICE (1-3/16") V6 EJE HÉLICE (1-1/4") V4/V6	PROP SHAFT (1-3/16") V6 PROP SHAFT (1-1/4") V4/V6	ASSE ELICA (1-3/16") V6 ASSE ELICA (1-1/4") V4/V6	ARBRE D'HÉLICE (1-3/16") V6 ARBRE D'HÉLICE (1-1/4") V4/V6
28	REC435123	336565	ARANDELA	THRUST WASHER	RONDELLA	RONDELLE
29	REC5004218	910994	MARCHA ATRÁS V6	REVERSE GEAR V6	MARCIA INDIETRO V6	MARCHE ARRIÈRE V6
30	REC382408	382408	ARANDELA COJINETE	THRUST BEARING	RONDELLA CUSCINETTO	RONDELLE ROULEMENT
31	REC314731	314731	ARANDELA	THRUST WASHER	RONDELLA	RONDELLE
32	REC305123	305123	TÓRICA	O-RING	O-RING	JOINT TORIQUE
33	REC382407	382407	COJINETE	BEARING	CUSCINETTO	ROULEMENT
34	REC5000074 REC5004257	5000074 5004257	COJINETE DIÁBOLO (1-3/16") COJINETE DIÁBOLO (1-1/4")	BEARING CARRIER (1-3/16") BEARING CARRIER (1-1/4")	CUSCINETTO (1-3/16") CUSCINETTO (1-1/4")	ROULEMENT (1-3/16") ROULEMENT (1-1/4")
35	REC908158	908158	TORNILLO	SCREW	VITE	VIS
36	CM431708	431708	ÁNODO	ANODE	ANODO	ANODE
37	REC333957	333957	LENGÜETA	TAB	LEVA DI SOSTEGNO	BAGUE DE RETENUE
38	REC350271	350271	TORNILLO	SCREW	VITE	VIS
39	REC387247 REC434467	387247 434467	COJINETE (Ø INT. 1-3/16") COJINETE (Ø INT. 1-1/4")	BEARING (INSIDE Ø 1-3/16") BEARING (INSIDE Ø 1-1/4")	CUSCINETTO (Ø INT. 1-3/16") CUSCINETTO (Ø INT. 1-1/4")	ROULEMENT (Ø INT. 1-3/16") ROULEMENT (Ø INT. 1-1/4")
40	REC341281 REC334950 REC26-76868	341281 334950 320862	RETÉN ACEITE (1-1/4") 1 PIEZA RETÉN ACEITE (1-1/4") 2 PIEZAS RETÉN ACEITE (1-3/16") 2 PIEZAS	OIL SEAL (1-1/4") 1 PC. OIL SEAL (1-1/4") 2 PCS. OIL SEAL (1-3/16") 2 PCS.	PARAOLIO (1-1/4") 1 PECE PARAOLIO (1-1/4") 2 PECE PARAOLIO (1-3/16") 2 PECE	JOINT SPI (1-1/4") 1 PIÈCE JOINT SPI (1-1/4") 2 PIÈCES JOINT SPI (1-3/16") 2 PIÈCES
41	REC126870	126870	ARANDELA	THRUST WASHER	RONDELLA	RONDELLE
42	REC320570	320570	ESPACIADOR	SPACER	DISTANZIATORE	RONDELLE BUTEE D'HELICE
43	REC398042	398042	KIT TUERCA HÉLICE	NUT & KEEPER	KIT DADO ELICA	KIT ECROU D'HELICE
44	REC3852056	306394	PASADOR	COTTER PIN	CHIAVISTELLO	PIN

2T V4 / V6 "O" (1979-06) RATIO V4 2.25:1 (.44), V6 1.86:1 (.54)
STROKES

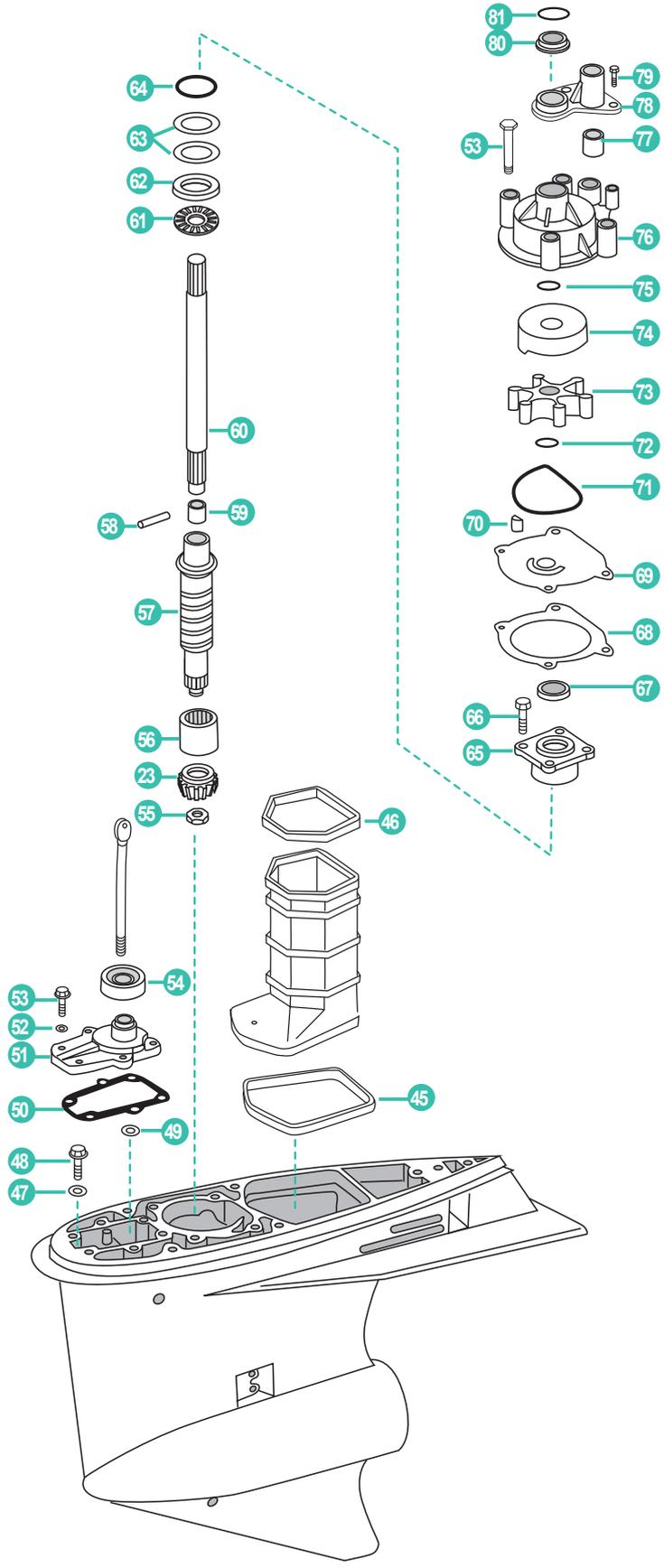

	REF	OEM				
45	REC320961	320961	RETÉN	SEAL	PARAOLIO	JOINT SPI
46	REC320936	320936	RETÉN	SEAL	PARAOLIO	JOINT SPI
47	REC437330	437330	ARANDELA	SEAL WASHER	RONDELLA	RONDELLE
48	REC341220	341220	TORNILLO	SCREW	VITE	VIS
49	REC318372	318372	TÓRICA	O-RING	O-RING	JOINT TORIQUE
50	REC324670	324670	JUNTA	GASKET	GUARNIZIONE	JOINT
51	REC5006241	5006241	TAPA CON RETÉN	COVER & SEAL ASSEMBLY	COPERCHIO E TENUTA	PLAQUE AVEC JOINT SPI
52	REC328702	328702	ARANDELA	WASHER	RONDELLA	RONDELLE
53	REC302325	302325	TORNILLO	SCREW	VITE	VIS
54	REC321008	321008	GRUESO	GROMMET	SPESSORE	CALE
55	REC11-35921	314730	TUERCA	NUT	DADO	ÉCROU
56	REC387817	387817	PIÑÓN COJINETE	PINION BEARING	PIGNONE CUSCINETTO	ROULEMENT À AIGUILLES
57	REC345905	345905	EJE TRANSMISION	LOWER DRIVE SHAFT	ALBERO DI TRASMISSIONE	ARBRE DE TRANSMISSION
58	REC311538	311538	PASADOR	PIN	CHIAVISTELLO	PIN
59	REC338504	338504	RETENEDOR	RETAINER	FERMO	RETENUE
60	REC5000615	5000615	EJE TRANSMISION SUPERIOR	DRIVE SHAFT (LONG)	ALBERO DI TRASMISSIONE SUPERIORE	ARBRE DE TRANSMISSION SUPERIEUR
61	REC387656	387656	ARANDELA COJINETE	THRUST BEARING	RONDELLA CUSCINETTO	RONDELLE ROULEMENT
62	REC327656	327656	ARANDELA	THRUST WASHER	RONDELLA	RONDELLE
63	REC323362	323362	SUPLEMENTO .003	SHIM .003	SPESSORE .003	CALE .003
	REC323361	323361	SUPLEMENTO .004	SHIM .004	SPESSORE .004	CALE .004
	REC314745	314745	SUPLEMENTO .005	SHIM .005	SPESSORE .005	CALE .005
64	REC314728	314728	TÓRICA	O-RING	O-RING	JOINT TORIQUE
65	REC439476	439476	CUERPO COJINETE Y RETÉN	BEARING HOUSING & SEAL	CORPO E CUSCINETTO	PALLIER DE ROULEMENT ET JOINT SPI
66	REC317624	317624	TORNILLO	SCREW	VITE	VIS
67	REC341280	341280	RETÉN ACEITE	OIL SEAL	PARAOLIO	JOINT SPI
68	REC338484	338484	JUNTA	GASKET	GUARNIZIONE	JOINT
69	REC338485	338485	TAPA	WEAR PLATE	COPERCHIO	PLAQUE DE POMPE
70	REC777129	331107	CHAVETA	KEY	CHIAVE	CLAVETTE
71	REC331353	331353	RETÉN	SEAL	PARAOLIO	JOINT SPI
72	REC302035	302035	TÓRICA	O-RING	O-RING	JOINT TORIQUE
73	REC5001593	5001593	IMPULSOR	IMPELLER	GIRANTE	TURBINE
74	REC338486	338486	TAPA BOMBA	PUMP CUP	COPERCHIO POMPA	INSERT DE POMPE
75	REC331188	331188	TÓRICA	O-RING	O-RING	JOINT TORIQUE
76	REC435990	435990	CUERPO BOMBA TRANSOM 20"	PUMP HOUSING (20 TRANSOM)	CORPO POMPA (TRANSOM 20")	CORPS DE POMPE (TRANSOM 20")
	REC5007968	435959	CUERPO BOMBA TRANSOM 25"	PUMP HOUSING (25 TRANSOM)	CORPO POMPA (TRANSOM 25")	CORPS DE POMPE (TRANSOM 25")
77	REC314008	314008	GRUESO	GROMMET	SPESSORE	CALE
78	REC338893	338893	TUBO GUÍA	TUBE GUIDE	TUBO GUIDA	TUBE GUIDE
79	REC306643	306643	TORNILLO	SCREW	VITE	VIS
80	REC320943	320943	GRUESO	GROMMET	SPESSORE	CALE
81	REC320961	320961	RETÉN	SEAL	PARAOLIO	JOINT SPI

2T V4 / V6 "M" (1979-06) RATIO V4 2.25:1 (.44), V6 1.86:1 (.54)
STROKES

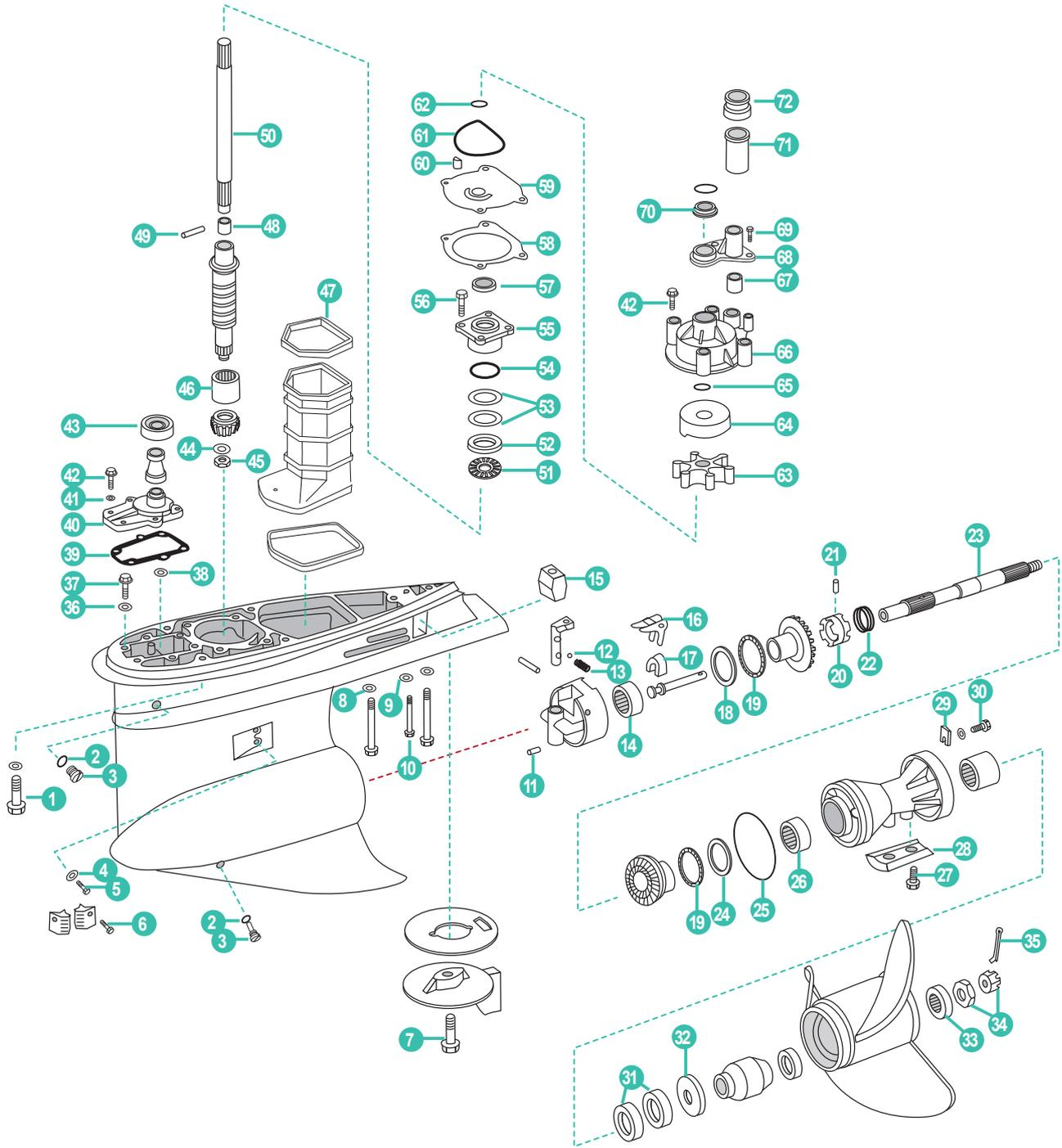

	REF	OEM				
1	REC331999	331999	TORNILLO	SCREW	VITE	VIS
2	REC3855081	311598	JUNTA	GASKET	GUARNIZIONE	JOINT
3	REC22-67892A05	318544	TORNILLO DRENAJE	DRAINING SCREW	VITE DRENAGGIO	VIS VIDANGE
4	REC332584	332584	RETÉN	SEAL	TENUTA	RETAINEUR
5	REC324852	324852	TORNILLO	SCREW	VITE	VIS
6	REC337061	337061	TORNILLO	SCREW	VITE	VIS
7	REC313715	313715	TORNILLO	SCREW	VITE	VIS
8	REC330265	330265	ARANDELA	WASHER	RONDELLA	RONDELLE
9	REC307161	307161	CIERRE	LOCK WASHER	CHIUSURA	RONDELLE GROWER
10	REC341219	341219	TORNILLO	SCREW	VITE	VIS
11	REC331880	331880	PASADOR	PIN	CHIAVISTELLO	PIN
12	REC160084	160084	BOLA	DETENT BALL	SFERA	BILLE
13	REC911962	911962	MUELLE	SPRING	MOLLA	RESSORT

	REF	OEM				
14	REC389039	389039	COJINETE	BEARING	CUSCINETTO	ROULEMENT
15	REC436745AL	436745	ÁNODO	ANODE	ANODO	ANODE
16	REC322938	322938	ELEVADOR	LEVER	LEVA	CROCHET
17	REC334163	334163	REGULADOR EJE	CRADLE	REGOLATORE ASSE	REGULATEUR D'AXE
18	REC327669	327669	ARANDELA	THRUST WASHER	RONDELLA	RONDELLE
19	REC389042	389042	ARANDELA COJINETE	THRUST BEARING	RONDELLA CUSCINETTO	RONDELLE ROULEMENT
20	REC337774	337774	SELECTOR	CLUTCH DOG	SELETTORE	CRABOT
21	REC313448	313448	PASADOR	CROSS PIN	CHIAVISTELLO	PIN
22	REC324369	324369	MUELLE	SPRING	MOLLA	RESSORT
23	REC356900 REC5004765	347371 5004765	EJE TRANSMISION EJE HÉLICE	LOWER DRIVE SHAFT PROP SHAFT	ASSE TRASMISSIONE ASSE ELICA	ARBRE DE TRANSMISSION ARBRE D'HELICE
24	REC349193	349193	ARANDELA	THRUST WASHER	RONDELLA	RONDELLE
25	REC326849	326849	TÓRICA	O-RING	O-RING	JOINT TORIQUE
26	REC382407	382407	COJINETE	BEARING	CUSCINETTO	ROULEMENT
27	REC908158	908158	TORNILLO	SCREW	VITE	VIS
28	CM431708	431708	ÁNODO	ANODE	ANODO	ANODE
29	REC333957	333957	LENGÜETA	TAB	LEVA DI SOSTEGNO	BAGUE DE RETENUE
30	REC350271	350271	TORNILLO	SCREW	VITE	VIS
31	REC341281 REC334950	341281 334950	RETÉN ACEITE 1 PIEZA RETÉN ACEITE 2 PIEZAS	OIL SEAL - 1 PC. OIL SEAL - 2 PCS.	PARAOLIO 1 PEZZO PARAOLIO 2 PEZZI	JOINT SPI 1 PIÈCE JOINT SPI 2 PIÈCES
32	REC126870	126870	ARANDELA	THRUST WASHER	RONDELLA	RONDELLE
33	REC320570	320570	ESPACIADOR	SPACER	DISTANZIALE	CALE
34	REC398042	398042	KIT TUERCA HÉLICE	NUT & KEEPER	KIT DADI ELICA	KIT TUERCA HELICE
35	REC3852056	306394	PASADOR	COTTER PIN	CHIAVISTELLO	PIN
36	REC437330	437330	ARANDELA	SEAL WASHER	RONDELLA	RONDELLE
37	REC341220	341220	TORNILLO	SCREW	VITE	VIS
38	REC318372	318372	TÓRICA	O-RING	O-RING	JOINT TORIQUE
39	REC324670	352165	JUNTA	GASKET	GUARNIZIONE	JOINT
40	REC5006241	5006241	TAPA Y RETÉN	COVER & SEAL ASSEMBLY	COPERCHIO E PARAOLIO	PLAQUE AVEC JOINT SPI
41	REC328702	328702	ARANDELA	WASHER	RONDELLA	RONDELLE
42	REC302325	302325	TORNILLO	SCREW	VITE	VIS
43	REC321008	321008	GRUESO	GROMMET	SPESSORE	CALE
44	REC350038	350038	ARANDELA	WASHER	RONDELLA	RONDELLE
45	REC11-35921	314730	TUERCA	NUT	DADO	ÉCROU
46	REC387817	387817	COJINETE PIÑÓN	PINION BEARING	CUSCINETTO PIGNONE	ROULEMENT À AIGUILLES
47	REC320936	320936	RETÉN	SEAL	PARAOLIO	JOINT SPI
48	REC338504	338504	RETENEDOR	RETAINER	FERMO	RETENUE
49	REC311538	311538	PASADOR	PIN	CHIAVISTELLO	PIN
50	REC5000614 REC5007672 REC5000624	5000614 5000623 5000624	EJE LARGO COLA 20" EJE LARGO COLA 25" EJE LARGO COLA 25"	DRIVE SHAFT 20" L DRIVE SHAFT 25" L DRIVE SHAFT 25" L	ASSE LUNGO PIEDE 20" ASSE LUNGO PIEDE 25" ASSE LUNGO PIEDE 25"	ARBRE DE TRANSMISSION 20" ARBRE DE TRANSMISSION 25" ARBRE DE TRANSMISSION 25"
51	REC387656	387656	ARANDELA COJINETE	THRUST BEARING	RONDELLA CUSCINETTO	RONDELLE ROULEMENT
52	REC327656	327656	ARANDELA	THRUST WASHER	RONDELLA	RONDELLE
53	REC323362 REC323361 REC314745	323362 323361 314745	SUPLEMENTO .003 SUPLEMENTO .004 SUPLEMENTO .005	SHIM .003 SHIM .004 SHIM .005	SPESSORE .003 SPESSORE .004 SPESSORE .005	CALE .003 CALE .004 CALE .005
54	REC314728	314728	TÓRICA	O-RING	O-RING	JOINT TORIQUE
55	REC439476	439476	CUERPO COJINETE Y RETÉN	BEARING HOUSING & SEAL	CORPO CUSCINETTO E PARAOLIO	PALLIER DE ROULEMENT ET JOINT SPI
56	REC317624	317624	TORNILLO	SCREW	VITE	VIS
57	REC341280	341280	RETÉN ACEITE	OIL SEAL	PARAOLIO	JOINT SPI
58	REC338484	338484	JUNTA	GASKET	GUARNIZIONE	JOINT
59	REC338485	338485	TAPA BOMBA	WEAR PLATE	COPERCHIO POMPA	PLAQUE DE POMPE
60	REC331107	331107	CHAVETA	KEY	CHIAVE	CLAVETTE
61	REC331353	331353	RETÉN	SEAL	TENUTA	JOINT
62	REC302035	302035	TÓRICA	O-RING	O-RING	JOINT TORIQUE
63	REC5001593	5001593	IMPULSOR	IMPELLER	GIRANTE	TURBINE
64	REC338486	338486	TAPA BOMBA	PUMP CUP	COPERCHIO POMPA	INSERT DE POMPE
65	REC331188	331188	TÓRICA	O-RING	O-RING	JOINT TORIQUE
66	REC435990	435959	CUERPO BOMBA	PUMP HOUSING	CORPO POMPA	CORPS DE POMPE
67	REC314008	314008	GRUESO	GROMMET	SPESSORE	CALE
68	REC338893	338893	TUBO GUÍA	TUBE GUIDE	TUBO GUIDA	TUBE GUIDE
69	REC306643	306643	TORNILLO	SCREW	VITE	VIS
70	REC320943	320943	GRUESO	GROMMET	SPESSORE	CALE
71	REC338636	338636	TUBO ESPACIADOR	TUBE SPACER	TUBO DISTANZIATORE	TUBE GUIDE
72	REC354580	338601	GRUESO	GROMMET	SPESSORE	CALE

2T V6 (1976-78)
 STROKES CAMBIO HIDRÁULICO | HYDRAULIC SHIFT | CAMBIO IDRAULICO | CHANGEMENT HYDRAULIQUE

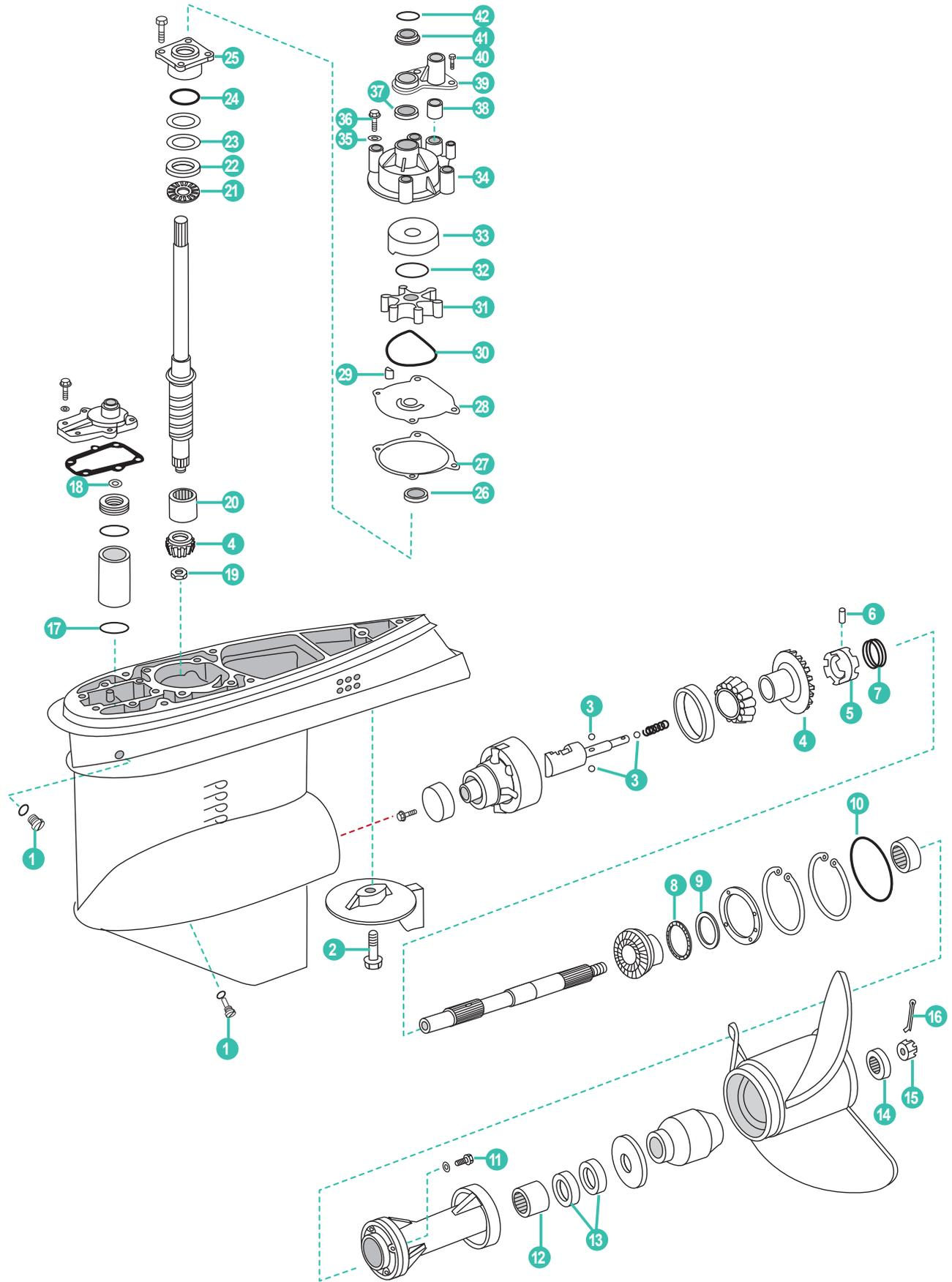

	REF	OEM				
1	REC10-79953Q04	307551	TAPÓN DRENAJE	DRAIN PLUG	TAPPO DRENAGGIO	BOUCHON DE VIDANGE
2	REC313715	313715	TORNILLO	SCREW, TRIM TAB	VITE	VIS
3	REC316506	316506	BOLA RETENEDORA	DETENT BALL	SFERA	BILLE
4	REC320635	320635	PIÑÓN Y MARCHA ADELANTE	PINION & FORWARD GEAR	PIGNONE E MARCIA IN AVANTI	KIT PIGNON AVANT
5	REC337774	320630	SELECTOR	CLUTCH DOG	SELETTORE	CRABOT
6	REC313448	313448	PASADOR SELECTOR	PIN, CLUTCH DOG	CHIAVISTELLO SELETTORE	PIN
7	REC324369	324369	MUELLE SELECTOR	SPRING, CLUTCH DOG	MOLLA SELETTORE	RESSORT
8	REC382408	382408	TOPE COJINETE	REVERSE THRUST BEARING	PUNTA CUSCINETTO	ROULEMENT
9	REC314731	314731	TOPE COJINETE	REVERSE THRUST WASHER	PUNTA CUSCINETTO	ROULEMENT
10	REC305123	305123	TÓRICA	O-RING PROP SHAFT CARRIER	O-RING	JOINT TORIQUE
11	REC316563	316563	TORNILLO	CARRIER RETAINER SCREW	VITE	VIS
12	REC387247	387247	AGUJA COJINETE EJE HÉLICE	NEEDLE BEARING, PROP SHAFT	AGHI CUSCINETTO ASSE ELICA	ROULEMENT À AIGUILLES
13	REC26-76868	320862	RETÉN EJE HÉLICE	PROP SHAFT SEAL	PARAOLIO ASSE ELICA	JOINT TORIQUE
14	REC320570	320570	TOPE HÉLICE	PROP NUT SPACER	PUNTA ELICA	RONDELLE BUTEE D'HELICE
15	REC5008966	320569	TUERCA HÉLICE	PROP NUT	DADO ELICA	ÉCROU D'HÉLICE
16	REC309955	309955	PASADOR TUERCA HÉLICE	PROP NUT COTTER PIN	CHIAVISTELLO DADO ELICA	GOUPILLE
17	REC320140	320140	ARO CAMBIO	O-RING, SHIFT	O-RING CAMBIO	JOINT TORIQUE
18	REC318372	318372	TÓRICA	O-RING, SHIFT ROD	O-RING	JOINT TORIQUE
19	REC11-35921	314730	TUERCA PIÑÓN	PINION NUT	DADO PIGNONE	ÉCROU
20	REC387817	387817	COJINETE PIÑÓN	PINION BEARING	CUSCINETTO PIGNONE	ROULEMENT
21	REC387656	387656	TOPE COJINETE	PINION, THRUST BEARING	PUNTA CUSCINETTO	ROULEMENT
22	REC327656	327656	TOPE ARANDELA	PINION, THRUST WASHER	PUNTA RONDELLA	RONDELLE
23	REC314745	314745	SUPLEMENTO .005	SHIM .005	SPESSORE .005	CALE .005
24	REC314728	314728	ARO COJINETE EJE COLA	O-RING DRIVE SHAFT BEARING	O-RING CUSCINETTO ASSE PIEDE	JOINT TORIQUE ROULEMENT D'ARBRE
25	REC439476	439476	CUERPO COJINETE Y RETÉN	BEARING HOUSING & SEAL	CORPO CUSCINETTO E PARAOLIO	CORS ROULEMENT ET JOINT
26	REC26-69188	321453	RETÉN ACEITE EJE COLA	OIL SEAL, DRIVE SHAFT	PARAOLIO, ASSE PIEDE	JOINT SPI
27	REC338484	338484	JUNTA TAPA	GASKET, PLATE	GUARNIZIONE COPERCHIO	JOINT
28	REC338485	321188	TAPA IMPULSOR	PLATE, IMPELLER	COPERCHIO GIRANTE	PLAQUE DE POMPE
29	REC308928	308928	CHAVETA	IMPELLER KEY	CHIAVE	CLAVETTE
30	REC331353	331353	RETÉN DE TAPA A CUERPO	SEAL, PLATE TO HOUSING	PARAOLIO DEL COPERCHIO E CORPO	JOINT SPI
31	REC777212	385528	IMPULSOR BOMBA AGUA	IMPELLER, W.P.	GIRANTE POMPA ACQUA	TURBINE
32	REC331188	321175	ARO IMPULSOR	O-RING IMPELLER	O-RING GIRANTE	JOINT TORIQUE
33	REC338486	338486	ACOPLE INOX	CUP	ACCOPIAMENTO INOX	INSERT INOX
34	REC5007968	435959	CUERPO	HOUSING	CORPO	CORPS DE POMPE
35	REC13-35048	305981	ARANDELA TORNILLO	WASHER, SCREW	RONDELLA, VITE	RONDELLE
36	REC302325	302873	TORNILLO BOMBA AGUA	SCREW, WATER PUMP	VITE, POMPA ACQUA	VIS
37	REC26-69188	321453	RETÉN	SEAL	TENUTA	JOINT SPI
38	REC314008	314008	GRUESO TUBO AGUA	WATER TUBE GROMMET	SPESSORE TUBO ACQUA	BAGUE DE TUBE D'EAU
39	REC338893	338893	TAPA TUBO AGUA	WATER TUBE COVER	COPERCHIO TUBO ACQUA	COUVERCLE TUBE D'EAU
40	REC306643	306643	TORNILLOS TAPA TUBO AGUA	WATER TUBE COVER SCREWS	VITI COPERCHIO TUBO ACQUA	VIS
41	REC320943	320943	GRUESOS TAPA TUBO AGUA	WATER TUBE COVER GROMMET	SPESSORE COPERCHIO TUBO ACQUA	BAGUE DE POMPE A EAU
42	REC25-30613	310585	TÓRICA	O-RING	O-RING	JOINT TORIQUE



REC80W90U3
REC80W90U6
RECGREU1
RECGREU12

P. 43

PIEZAS TRANSMISIÓN

STERN DRIVE PARTS

PARTI PIEDE

PIECES D'EMBASES

PIÑONES MARCHA AVANTE

POSITIVE GEAR

REF	OEM	RATIO	4T STROKES	2T STROKES
REC435123	435123	12:27		✓



REF	OEM	J10 / J15 (2002-04)	4T STROKES	2T STROKES
REC57510-93910	5033191		✓	



PIGNONI MARCIA AVANTI

PIGNON MARCHÉ AVANT

REF	OEM	J 4, 5, 6 HP	4T STROKES	2T STROKES
REC57510-91J00	5034203 5030277 5031203		✓	



REF	OEM	J/BJ 25, 30 HP	4T STROKES	2T STROKES
REC57510-89J00	5032698 5032099 5036016		✓	



PIÑONES MARCHA ATRÁS

REVERSE GEAR

REF	OEM	J/BJ 25, 30 HP	4T STROKES	2T STROKES
REC57521-96312	5032100		✓	



PIGNONI MARCIA INDIETRO

PIGNON MARCHÉ ARRIÈRE

REF	OEM	J10 / J15 (2002-04)	4T STROKES	2T STROKES
REC57521-93910	5033192		✓	



REF	OEM	J4, 5, 6 HP	4T STROKES	2T STROKES
REC57521-91J00	5030278		✓	



REF	OEM	J/BJ 25, 30 HP	4T STROKES	2T STROKES
REC57521-89J00	5032100		✓	



KITS DE PIÑONES COMPLETO

COMPLETE GEAR SET

REF	OEM
REC5004218	5004218



KIT PIGNONI COMPLETO

KIT PIGNONS COMPLET

REF	OEM
REC986979	22631 + 22632 + 22633





PIÑONES ATAQUE

INITIATIVE GEAR

PIGNONI INIZIATIVA

PIGNON D'ATTAQUE

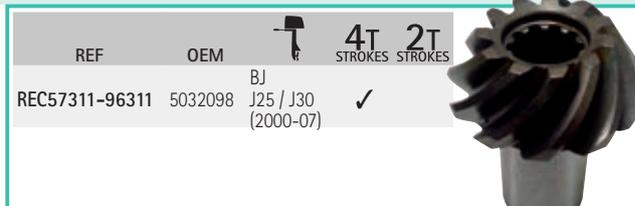
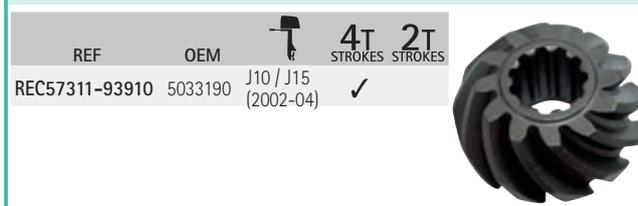

GRUESO PINONES ATAQUE

SHIM INITIATIVE GEAR

SPESSORE PIGNONI INIZIATIVA

CALE PIGNON D'ATTAQUE

REF	OEM	4T STROKES	2T STROKES	Thickness
REC09160-20044	5032969			0.7
REC09160-20041	5032985	J10 / J15	✓	1.0
REC09160-20042	5032967	(2002-07)	✓	1.1
REC09160-20043	5032968			1.2

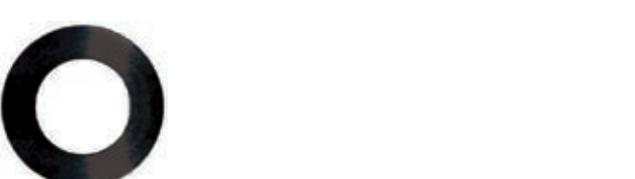

ARANDELA PINONES ATAQUE

WASHER INITIATIVE GEAR

RONDELLA PIGNONI INIZIATIVA

RONDELLE PIGNON D'ATTAQUE

REF	OEM	4T STROKES	2T STROKES	Dimensions
REC09160-26015	5031232	E40 / J40 / BJ40	✓	26.2 x 42 x 4.0 mm
REC09160-21009	5032970	E50 / J50 / BJ50 (1999-06)	✓	21 x 35 x 2.75 mm
REC09160-20027	5032966	J10, J15 (2002-07)	✓	
	5032966	J10, J15 (2002-07)	✓	



SELECTOR

CLUTCH DOGS

SELETTORE

CRABOT



MUELLE PARA SELECTOR SPRING CLUTCH

REF	OEM	
REC09440-32008	5033037	J/BJ 10, 15 HP



new

REF	OEM		
REC09440-40002	5031286	REC57621-94403	J/BJ 40, 50 HP



new

MOLLA SELETTORE

RESSORT DE SELECTEUR

REF	OEM	
REC09440-05027	5033034	J 10, 15 HP



new

PIN

PIN

SPINOTTO

PIN

REF	OEM	
REC57632-97L00	5030282	J4, 5, 6, 10, 15 HP



new

REF	OEM	
REC09202-05022	5031245	J/BJ 40, 50 HP



new

PASADOR PARA SELECTOR CLUTCH PIN

PIN SELETTORE

PIVOT

REF	OEM	
REC57634-88L00	5031251	J/BJ 40, 50 HP



new

REF	OEM	
REC09209-08016	5031880	J/BJ 25 ,30 HP



new

VARILLA PARA SELECTOR ROD PUSH

ASTA PRESSIONE

TIGE DE POUSSEE

REF	OEM	
REC57631-93901	5033196	J10, 15 HP



new

REF	OEM	
REC57631-95303	5031549	J/BJ 40, 50 HP



new

REF	OEM	
REC57631-96301	5032103	J/BJ 25 ,30 HP



new

			KIT + 	KIT		
2 & 3 CYL LOOPCHARGED						
25D	1989-05		REC22660			REC332491
35 (AR, AE & AT)	1987			REC433570	REC433570	REC319895
40	1975-88			REC433570	REC433570	REC319895
40	1989-05		REC22660			REC332491
48	1987-88			REC433570	REC433570	REC319895
18	1989-96		REC22660			REC332491
50	1979-88			REC433570	REC433570	REC319895
50	1989-05		REC22660			REC332491
50 (S CYD)	1995-97		REC22670			REC318303
55 Elect	1979-81			REC433570	REC433570	REC319895
60 Elec	1980-88			REC433570		REC319895
60 (3-Cyl. 20)	1986-97		REC22670			REC318303
65 Comm.	1984-97		REC22670			REC318303
70 E	1975		REC22670			REC318303
70 20	1976-97		REC22670			REC318303
75 20	1975-88		REC22670			REC318303
V4						
85	1977					REC323664
85	1978-80, 1991-95		REC986979			REC323664
88	1987-96		REC986979			REC323664
90	1981-97		REC986979			REC323664
90 V4 60° 2.25:1 "O"	1995-99		GLM22650	REC435123		REC337774
100	1979-80		REC986979			REC323664
100	1989-90		REC986979			REC323664
100 2.25:1 "O"	1991		GLM22650	REC435123		REC337774
100 Comm. (S)	1989-90		REC986979			REC323664
100 Comm. 2.25:1 "O"	1987, 92, 93		GLM22650	REC435123		REC337774
100 Comm. D 2.25:1 "O"	1994-99		GLM22650	REC435123		REC337774
100 Comm. (E J) 2.25:1 "O"	1989		GLM22650	REC435123		REC337774
100 Comm. "O"	1990		GLM22650	REC435123		REC337774
110	1986-89		REC986979			REC323664
112	1994-96		REC986979			REC323664
115	1977		REC986979			REC323664
115	1990-97		REC986979			REC323664
115 V4 60° 2.25:1 "O"	1995-99		GLM22650	REC435123		REC337774
120	1986-92		REC986979			REC323664
120 2.25:1 "O"	1990		GLM22650	REC435123		REC337774
120 TL, TX	1993		REC986979			REC323664
120 TX 2.25:1 "O"	1993		GLM22650	REC435123		REC337774
125 Comm. (ESX)	1989-90		REC986979			REC323664
125 Comm. 2.25:1 "O"	1989-92		GLM22650	REC435123		REC337774
125 Comm. E, R 2.25:1 "O"	1993-96		GLM22650	REC435123		REC337774
125 ESX (F) 2.25:1 "O"	1993		GLM22650	REC435123		REC337774
125 ESX (S)	1993		REC986979			REC323664
130 2.25:1 "O"	1997		GLM22650	REC435123		REC337774
140	1978-84		REC986979			REC323664
140	1986-87		REC986979			REC323664
140 TL	1988-94		REC986979			REC323664
140 TX 2.25:1 "O"	1988-90, 92, 93		GLM22650	REC435123		REC337774
V6						
150	1978			REC320635		REC337774
150	1979-87		REC5004218			REC337774
150	1988-90		REC5004218			REC337774
150	1991-97		REC5004218			REC337774
150 Comm.	1993-95		REC5004218			REC337774
150 Comm.	1989-90		REC5004218			REC337774
155 Comm. WTA	1989		GLM22650	REC435123		REC337774
155 Comm. WTP	1989		REC5004218	REC323664		REC337774
175	1977-78			REC320635		REC337774
175	1979-87		REC5004218			REC337774
175	1988-90		REC5004218	REC323664		REC337774
175	1991-97		REC5004218			REC337774
185	1984-85		REC5004218			REC337774
185	1990		REC5004218			REC337774
185	1991-94		REC5004218			REC337774
200	1976-78			REC320635		REC337774
200	1979-83		REC5004218			REC337774
200	1986-87		REC5004218	REC323664		REC337774
200	1988-90		REC5004218			REC337774
200	1991-06		REC5004218			REC337774
200 Comm.	1990-91		REC5004218			REC337774
225	1986-87		REC5004218			REC337774
225	1988-90		REC5004218			REC337774
225	1991-06		REC5004218			REC337774
235	1978			REC320635		REC337774
235	1979-85		REC5004218			REC337774
1.6L Comm.	1988		GLM22650	REC435123		REC337774

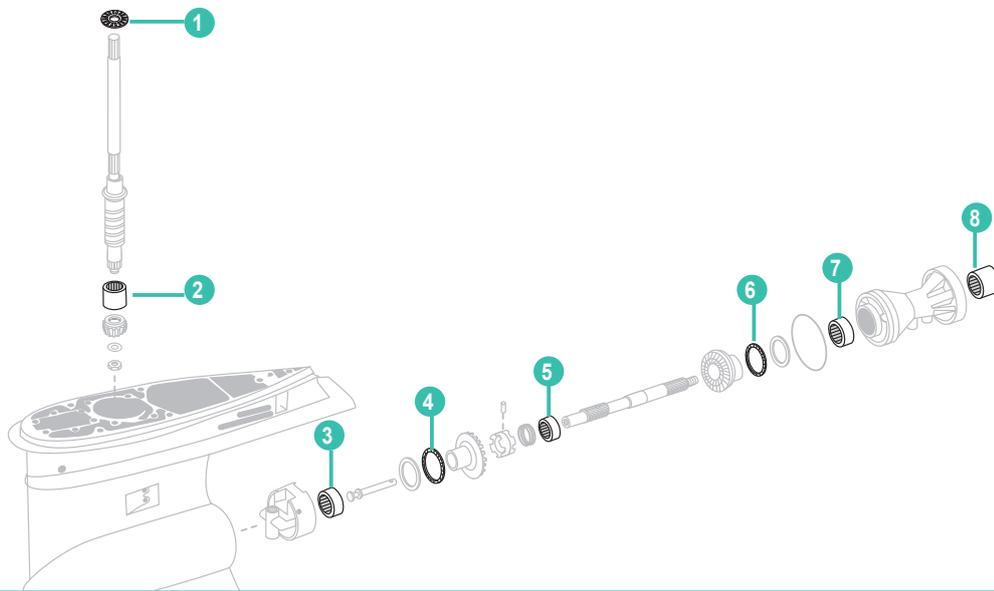

GUÍA COJINETES COLA	LOWER HOUSING BEARING GUIDE	GUIDA CUSCINETTI PIEDE			GUIDE ROULEMENT D'EMBASE				
		1	2	3	4	5	6	7	8
2 CYL. LOOPCHARGED (1975-85) 40 - 60 HP									
40	1984-85								
50	1975-85	REC31-32575T1	REC386766					REC386764	REC386765
55	1976-85								
60	1980-85								
2 CYL. LOOPCHARGED (1986-05) 40 - 60 HP									
40 Pequeño antiguo Small Old	1986-88	REC31-32575T1	REC386766					REC386764	REC386765
Gambo corto vecchio Petit, ancien									
40 Pequeño nuevo Small New	1989-00	REC398901	REC382343	REC382407	REC397538	REC432264	REC397537	REC386764	REC386765
Gambo corto nuovo Petit, nouveau		REC333771			REC333725		REC332514		
45 Pequeño nuevo Small New	1989-97	REC398901	REC382343	REC382407	REC397538		REC397537	REC386764	REC386765
Gambo corto nuovo Petit, nouveau		REC333771			REC333725		REC332514		
45 Largo Large Lungo Longue	1987-97	REC385068	REC382343	REC382407	REC385043		REC382408	REC382407	REC379504
		REC317230			REC324766		REC313447		
48 Pequeño nuevo Small New	1989-96	REC398901	REC382343	REC382407	REC397538	REC432264	REC397537	REC386764	REC386765
Gambo corto nuovo Petit, nouveau		REC333771			REC333725		REC332514		
48 Largo Large Lungo Longue	1987-96	REC385068	REC382343	REC382407	REC385043		REC382408	REC382407	REC379504
		REC317230			REC324766		REC313447		
50 Pequeño antiguo Small Old	1986-88	REC31-32575T1	REC386766					REC386764	REC386765
Gambo corto vecchio Petit, ancien									
50 Pequeño nuevo Small New	1989-05	REC398901	REC382343	REC382407	REC397538	REC432264	REC397537	REC386764	REC386765
Gambo corto nuovo Petit, nouveau		REC333771			REC333725		REC332514		
50 Largo Large Lungo Longue	1986-05	REC385068	REC382343	REC382407	REC385043		REC382408	REC382407	REC379504
		REC317230			REC324766		REC313447		
55 Pequeño antiguo Small Old	1986-88	REC31-32575T1	REC386766					REC386764	REC386765
Gambo corto vecchio Petit, ancien									
55 Pequeño nuevo Small New	1989-05	REC398901	REC382343	REC382407	REC397538		REC397537	REC386764	REC386765
Gambo corto nuovo Petit, nouveau		REC333771			REC333725		REC332514		
55 Largo Large Lungo Longue	1986-05	REC385068	REC382343	REC382407	REC385043		REC382408	REC382407	REC379504
		REC317230			REC324766		REC313447		
60 Pequeño antiguo Small Old	1986-88	REC31-32575T1	REC386766					REC386764	REC386765
Gambo corto vecchio Petit, ancien									
60 Largo Large Lungo Longue	1986-88	REC385068	REC382343	REC382407	REC385043		REC382408	REC382407	REC379504
		REC317230			REC324766		REC313447		
3 CYL. LOOPCHARGED (1973-01) 65 - 75 HP									
65 Largo Large Lungo Longue	1973	REC385068	REC382343	REC382407	REC385043		REC382408	REC382407	REC379504
		REC317230			REC324766		REC313447		
65 Largo Large Lungo Longue	1984-01	REC385068	REC382343	REC382407	REC385043		REC382408	REC382407	REC379504
		REC317230			REC324766		REC313447		
70 Pequeño Small Corto Petit	1974-01	REC31-32575T1	REC386766					REC386764	REC386765
75 Pequeño Small Corto Petit	1979-85	REC31-32575T1	REC386766					REC386764	REC386765
75 Largo Large Lungo Longue	1975-88	REC385068	REC382343	REC382407	REC385043		REC382408	REC382407	REC379504
		REC317230			REC324766		REC313447		
V4 (1978-83)									
85	1978-80	REC387656	REC384195	REC382407	REC385043		REC382408	REC382407	REC379504
		REC327656			REC324766		REC314731		
V4 (1984+)									
80 Pequeño Small Corto Petit	1991-99	REC387656	REC384195	REC382407	REC385043		REC382408		REC379504
		REC327656			REC324766		REC314731		
80 "0"	1991-99	REC387656	REC387817	REC389039	REC389042		REC382408	REC382407	REC434467
		REC327656			REC327669		REC314731		
90 Pequeño Small Corto Petit	1984-03	REC387656	REC384195	REC382407	REC385043		REC382408	REC382407	REC379504
		REC327656			REC324766		REC314731		
90 "0"	1984-90	REC387656	REC387817	REC389039	REC389042		REC382408	REC382407	REC387247
		REC327656			REC327669		REC314731		
90 "0"	1991-03	REC387656	REC387817	REC389039	REC389042		REC382408	REC382407	REC434467
		REC327656			REC327669		REC314731		
100 Pequeño Small Corto Petit	1984-05	REC387656	REC384195	REC382407	REC385043		REC382408	REC382407	REC379504
		REC327656			REC324766		REC314731		
100 "0"	1984-90	REC387656	REC387817	REC389039	REC389042		REC382408	REC382407	REC387247
		REC327656			REC327669		REC314731		
100 "0"	1991-05	REC387656	REC387817	REC389039	REC389042		REC382408	REC382407	REC434467
		REC327656			REC327669		REC314731		
115 Pequeño Small Corto Petit	1984	REC387656	REC384195	REC382407	REC385043		REC382408	REC382407	REC379504
		REC327656			REC324766		REC314731		

		1	2	3	4	5	6	7	8
115 "O" Type	1984-90	REC387656 REC327656	REC387817	REC389039	REC389042 REC327669		REC382408 REC314731	REC382407	REC387247
115 "O" Type	1991	REC387656 REC327656	REC387817	REC389039	REC389042 REC327669		REC382408 REC314731	REC382407	REC434467
120 "O" Type	1985-90	REC387656 REC327656	REC387817	REC389039	REC389042 REC327669		REC382408 REC314731	REC382407	REC387247
120 "O" Type	1991-94	REC387656 REC327656	REC387817	REC389039	REC389042 REC327669		REC382408 REC314731	REC382407	REC434467
125 "O" Type	1989-90	REC387656 REC327656	REC387817	REC389039	REC389042 REC327669		REC382408 REC314731	REC382407	REC387247
125 "O" Type	1991-98	REC387656 REC327656	REC387817	REC389039	REC389042 REC327669		REC382408 REC314731	REC382407	REC434467
130 Pequeño Small Corto Court	1995-00	REC387656 REC327656	REC384195	REC382407	REC385043 REC324766		REC382408 REC314731	REC382407	REC379504
130 "O" Type	1995-00	REC387656 REC327656	REC387817	REC389039	REC389042 REC327669		REC382408 REC314731	REC382407	REC434467
135 Pequeño Small Corto Court	2001	REC387656 REC327656	REC384195	REC382407	REC389042 REC327669		REC382408 REC314731	REC382407	REC379504
135 "O" Type	2001	REC387656 REC327656	REC387817	REC389039	REC389042 REC327669		REC382408 REC314731	REC382407	REC434467
135 "M"	2002	REC387656 REC327656	REC387817	REC389039	REC389042 REC327669		REC389042 REC349193	REC382407	
140 Pequeño Small Corto Court	1984	REC387656 REC327656	REC384195	REC382407	REC385043 REC324766		REC382408 REC314731	REC382407	REC379504
140 "O"	1985-90	REC387656 REC327656	REC387817	REC389039	REC389042 REC327669		REC382408 REC314731	REC382407	REC387247
140 "O"	1991-94	REC387656 REC327656	REC387817	REC389039	REC389042 REC327669		REC382408 REC314731	REC382407	REC434467
V6 (1979-90)									
150	1979-90	REC387656 REC327656	REC387817	REC389039	REC389042 REC327669		REC382408 REC314731	REC382407	REC387247
V6 (1991+)									
150 "O"	1991	REC387656 REC327656	REC387817	REC389039	REC389042 REC327669		REC382408 REC314731	REC382407	REC434467
150 "M"	2002						REC389042		
175 "M"	2002						REC389042		
175 "O"	1991						REC349193 REC382408		
185 "O"	1993-94						REC314731 REC382408		
200 "O"	1991						REC314731 REC382408		
200 "M"	2002						REC314731 REC389042		
225 "O"	1991						REC349193 REC382408		
225 "M"	2002						REC314731 REC389042 REC349193		

EJE TRANSMISIÓN INFERIOR		LOWER DRIVE SHAFT				ASSE TRANSMISSIONE INFERIORE		ARBRE DE TRANSMISSION INFERIEUR			
REF	OEM			Ø	2	1		REF	OEM		
REC346006	346006	V4 90°	8 - 3/4"		1 - 1/8"	6	V4 All Crossflow	1978-97	Small V4 90°	REC346006	346006
REC345905	345905	"O"	9 - 1/2"		1 - 1/8"	19	V4 All Crossflow	1984-97	"O"	REC345905	345905
REC356900	347371	"M"	9 - 1/2"		1 - 1/8"	20	V4 90° Loopcharged	1985-98	"O"	REC345905	345905
REC335679	335679	V8	10"		1 - 9/32"	19	V4 60°	1995-06	"O"	REC345905	345905
							V6 90°	1978-06	"O"	REC345905	345905
							V6 60°	1991-06	"O"	REC345905	345905
							V6	2002-06	"M"	REC356900	347371



EJE TRANSMISIÓN INFERIOR. COJINETES		LOWER DRIVE SHAFT BEARING		ALBERO DI TRASMISSIONE INFERIORE, CUSCINETTO		ROULEMENT D'ARBRE DE TRANSMISSION INFERIEUR	
REF	OEM						
REC09263-22L03	5031256	J/BJ 40, 50 HP		REC09263-20046	5031883	J/BJ 25, 30 HP	
REC09263-15019	5033002	J10, 15 HP					

EJE TRANSMISIÓN SUPERIOR

UPPER DRIVE SHAFT

ASSE TRANSMISSIONE SUPERIORE

ARBRE DE TRANSMISSION SUPERIEUR

REF	OEM	
REC5000618	5000618	25 - 1/4"
REC5000626	5000626	30 - 1/4"
REC5000614	5000614	25 - 11/16"
REC5007672	5000623	30 - 11/16"
REC5000615	5000615	24 - 3/4"
REC5000624	5000624	29 - 3/4"



	REF	OEM		TRANSOM
J10 J15	2002-07	REC57100-93902	5033188	20"
V4 All	1978-91	REC5000618	5000618	25 - 1/4" 20" Standard
V4 All	1978-91	REC5000626	5000626	30 - 1/4" 25" Standard
V4 90°	1992-98	REC5000614	5000614	25 - 11/16" 20" Standard
V4 90°	1992-98	REC5007672	5000623	30 - 11/16" 25" Standard
V4 60°	1995-06	REC5000615	5000615	24 - 3/4" 20" Standard
V4 60°	1995-06	REC5000624	5000624	29 - 3/4" 25" Standard
V6 All	1976-91	REC5000618	5000618	25 - 1/4" 20" Standard
V6 All	1976-91	REC5000626	5000626	30 - 1/4" 25" Standard
V6 90°	1992-06	REC5000614	5000614	25 - 11/16" 20" Standard
V6 90°	1992-06	REC5007672	5000623	30 - 11/16" 25" Standard
V6 60°	1991-06	REC5000615	5000615	24 - 3/4" 20" Standard
V6 60°	1991-06	REC5000624	5000624	29 - 3/4" 25" Standard

EJE TRANSMISIÓN SUPERIOR. COJINETES

UPPER DRIVE SHAFT BEARING

ALBERO DI TRANSMISSIONE SUPERIORE. CUSCINETTO

ROULEMENT D'ARBRE DE TRANSMISSION SUPERIEUR

REF	OEM	
REC08110-60020	5033299	J10, 15 HP



REF	OEM	
REC09265-17002	5031885	J/BJ 25 HP J 30 HP



EJE HÉLICE

PROP SHAFT

ASSE ELICA

ARBRE D'HÉLICE

REF	OEM			Ø	2	1	3
REC439138	439138	2 Cyl. Loopcharged Small	1989-05	13 - 13/32"	1.0"	13	REC320305
	436834	V4 60° Small	1995-06	16 - 9-16"	1 - 1/8"	13	REC127084
REC439185	439185	2 - 3 Cyl. Loopcharged	1975-06	14 - 29/64"	1 - 1/8"	13	REC127084
REC395209	395209	"O" Large	1979-90	17 - 27/22"	1 - 3/16"	15	
REC436888	436888	V4 90° Small	1989-05	15 - 7/16"	1 - 1/8"	13	REC127084
REC5004765	5004765	"O" Large "M" Large	1991-06 2001-06	17 - 7/8"	1 - 1/4"	15	REC126870

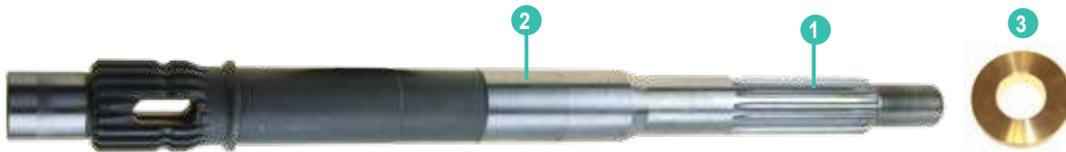

	REF	OEM		
J10	2002-07	4 T / Strokes	REC57610-93901	5033193
J15	2002-07	4 T / Strokes	REC57610-93901	5033193
2 Cyl. Loopcharged	1989-06	Pequeño Small Corto Court	REC439138	439138
2 & 3 Cyl. Loopcharged	1975-06	Largo Large Lungo Long	REC439185	439185
V4 All Crossflow	1978-98	Pequeño Small Corto Court (V4 90°)	REC436888	436888
V4 90° All	1984-90	"O"	REC395209	395209
V4 90° All	1991-98	"O"	REC5004765	5004765
V4 60°	1995-06	"O"	REC5004765	5004765
V6 90°	1978-90	"O"	REC395209	395209
V6 90°	1991-06	"O"	REC5004765	5004765
V6 60°	1991-06	"O"	REC5004765	5004765
V6	2002-06	"M"	REC5004765	5004765

CASQUILLO BASCULANTE BUSH SWIVEL TAPO GIREVOLE BAGUE TOURNANTE

REF	OEM	4T STROKES	2T STROKES
REC43211-87JL0	5032058	E25, E30, E40, E50 J10, J15, J25, J30, J40, J50 BJ40, BJ50 (2000-07)	✓



REF	OEM	4T STROKES	2T STROKES
REC43711-97E11	5030852	J/BJ 60 --> 225 HP	✓



new

REF	OEM	4T STROKES	2T STROKES
REC43211-94401	5032058	J10, 15, 25, 30, 40, 50 HP	✓



new

BOMBA DE ACEITE OIL PUMP POMPA OLIO DE POMPE À HUILE

REF	OEM	J/BJ
REC08110-60020	5033299	J/BJ 200, 225 HP



new

FUELLES VARILLA DE CAMBIO SHIFT, BELOW MANICOTTO MARCIE SOUFFLET DU LEVIER DE CHANGEMENT DE VITESSE

REF	OEM	J/BJ
REC25222-93901	5030215	J4, 5, 6, 10, 15 HP



new

REF	OEM	J/BJ
REC25222-96300	25222-96300	J25, 30 HP



new

ARO TÓRICO VARILLA DE CAMBIO SHIFT, O-RING O-RING MARCE JOINT TORIQUE DU LEVIER

REF	OEM	J/BJ	Size
REC09280-08005	5031260	J2 --> J50 HP	1,8 x 7,7 mm



new

REF	OEM	J/BJ	Size
REC09280-11005	5031261	BJ/J 40, 50 HP	2,4 x 10,8 mm



new

TUERCA VARILLA DE CAMBIO TURNBUCKE, CUTCH ROD DADO ASTA CAMBIO ECROU DU LEVIER

REF	OEM	4T STROKES	2T STROKES
REC23311-95DL0	5031449	E25, E30, E40 J10, J15, J25, J30, J40, J50 BJ40, BJ50 (1999-07)	✓



new

TORNILLOS Y JUNTAS DE DRENAJE

DRAIN, SCREW AND GASKETS

VITI E GUARNIZIONE, DRENAGGIO

VIS ET JOINTS DE VIDANGE

REF	OEM		
REC09248-10008	5030094	4 -->	140 HP 10 x 7.2 mm



new

REF	OEM		
REC55128-93J10	5035151	J/BJ	200, 225 HP



new

REF	OEM		
REC09168-10034	5034799	J/BJ	200, 225 HP



new

REF	OEM		
REC59178-97J00	5037356	J2	HP



new

TUBO DRENAJE BOMBA DE AGUA

DRAIN WATER TUBE

TUBO DRENAGGIO ACQUA

TUBE DE VIDANGE DE LA POMPE A EAU

REF	OEM		
REC17453-93901	5033111 5035609	J10	,1 5HP



new

DIÁBOLO

DIABOLO

DIABOLO

DIABOLO

REF	OEM		
REC56120-93900	5032743	J10	,15 HP



new

REF	OEM		
REC56120-96332-OEP	5034711	J/BJ	25, 30 HP



new

ARO TÓRICO DEL DIÁBOLO

DIABOLO, O-RING

O-RING DIABOLO

JOINT TORIQUE DU DIABOLO

REF	OEM		
REC09280-57002	5033010	J10	,15 HP 3.5 x 65.2 mm



new

REF	OEM		
REC09280-75001	5031263	J/BJ	40, 50 HP 3.3 x 75 mm



new

COJINETE DE DIÁBOLO

DIABOLO BEARING

CUSCINETTO DIABOLO

ROULEMENT DE DIABOLO

REF	OEM		
REC08110-60050	5033303	J10	,15 HP



new

REF	OEM		
REC08113-60060	5032295	BJ/J	25, 30 HP



new

REF	OEM		
REC09263-20047	5031884	J/BJ	25, 30 HP



new

REF	OEM		
REC09263-22020	5031255	J/BJ	40, 50 HP



new

BOMBA DE AGUA

WATER PUMP

POMPA ACQUA

**ROULEMENT DE POMPE
A EAU**

REF	OEM	
REC09263-25062	5031258	J/BJ 40, 50 HP



REF	OEM	
REC09263-25025	5031257	J/BJ 40, 50 HP



KIT REPARACION COLA

GEARCASE SEAL KIT

KIT RIPARAZIONE PIEDE

**KIT REPARATION
EMBASE**

**CAMBIO MECÁNICO
ESCAPE POR HELICE**

**MECHANICAL SHIFT
THRU-PROP EXHAUST**

**CAMBIO MECCANICO,
SCARICO TRAMITE L'ELICA**

**CHANGEMENT DE VITESSE
MECANIQUE**

REF	OEM	
REC396350	396350	9.9, 15 HP (-1974)



REF	OEM	
REC396351	396351	2 Cyl. Crossflow 20, 25, 30, 35 HP



REF	OEM	
REC433550	433550	40, 48, 50 HP 2 cyl Loopcharged (1989-05)



REF	OEM	
REC396355	396355	Cola pequeña Small housing Gambo corto Courte 2 cyl Loopcharged (1975-88) 40 - 60 HP 3 cyl Loopcharged (1975-88) 60 - 75 HP



REF	OEM	
REC5000309	5000309	Cola larga Large housing Gambo lungo Longue 2 cyl Loopcharged (1975-06) 40 - 60 HP 3 cyl Loopcharged (1975-01) 60 - 75 HP



**CAMBIO MECÁNICO
V4, V6, V8 (1978-06)**

**MECHANICAL SHIFT
V4, V6, V8 (1978-06)**

**CAMBIO MECCANICO
V4, V6, V8 (1978-06)**

**CHANGEMENT MÉCANIQUE
V4, V6, V8 (1978-06)**

REF	OEM
REC5006373	5006373



CAMBIO ELÉCTRICO ESCAPE EN ALETA DE CAVITACION

ELECTRIC SHIFT CAVITATION PLATE EXHAUST

CAMBIO ELETTRICO SCARICO NELL'ALETTA DI CAVITAZIONE

CHANGEMENT DE VITESSE ELECTRIQUE ECHAP PAR LA PLAQUE DE CAVITATION

REF	OEM	
REC87608	V4 (1962-68)	



CAMBIO ELÉCTRICO/HIDRAULICO ESCAPE A TRAVES DE HELICE

ELECTRIC / HYDRAULIC SHIFT THRU-PROP-EXHAUST

CAMBIO ELETTRICO / IDRAULICO CON SCARICO DALL'ELICA

CHANGEMENT DE VITESSE ELECTRIQUE / HYDRAU ECHAP PAR L'HELICE

REF	OEM	
REC87622	2 Cyl Loopcharged (1971-74)	



REF	OEM	
REC43713	55, 100, 125 HP V4 Crossflow (1971-72)	

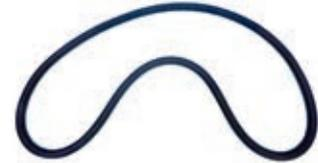

COLA DE 2 PIEZAS CON ESCAPE EN ALETA DE CAVITACION

TWO-PIECE GEARCASE WITH CAVITATION PLATE EXHAUST

PIEDE 2 PIECI CON SCARICO NELL'ALETTA DI CAVITAZIONE

CARTER EN DEUX PARTIES ECHAPPEMENT PAR LA PLAQUE DE CAVITATION

REF	OEM	
REC87604	5.5, 6 HP (1955-67)	



REF	OEM	
REC87607	25, 28, 30, 33, 35, 40 HP (1955-73) Cambio manual Manual shift Cambio manuale Changement manual	



REF	OEM	
REC87606	18 HP (1958-65)	



REF	OEM	
REC87617	18 HP (16 HP (1968-79))	



REF	OEM	
REC87619	20, 25 HP (1979-82)	



REF	OEM	
REC396352	396352 25, 28 HP (1985+)	



GUÍA KITS REPARACIÓN			GEARCASE SEAL KIT APPLICATION			GUIDA KIT RIPARAZIONE PIEDE			GUIDE KIT REPARATION		
		REF			REF			REF			REF
5.5		1955-67	REC87604	85 V4	1973-83	REC5006373					
6		1955-67	REC87604	85	1991-95	REC5006373					
6		1968-79	REC87617	88	1985	REC5006373					
7.5		1955-67	REC87604	90 Elect.	1964-65	REC87608					
9.9/15		1974	REC396350	90 V4	1973-83	REC5006373					
18		1958-65	REC87606	90	1985	REC5006373					
20		1966-73	REC87606	100 V4	1973-83	REC5006373					
20		1981-82	REC87619	100 Comm.	1984-95	REC5006373					
20		1985	REC396351	100	1991-01	REC5006373					
25		1955-59	REC87607	110 V4	1973-83	REC5006373					
25		1969-78	REC87606	110	1985-Up	REC5006373					
25		1979-82	REC87619	115 V4	1973-83	REC5006373					
25		1984	REC396352	115	1985-Up	REC5006373					
25		1985	REC396351	120	1985-92	REC5006373					
25		1990-95	REC433550	120	1993-Up	REC5006373					
25 Comm.		1985	REC396352	125	1991-98	REC5006373					
28		1962-70	REC87607	125 Comm.	1991-93	REC5006373					
28		1985	REC396352	135 V4	1973-83	REC5006373					
30		1955-59	REC87607	140 V4	1973-83	REC5006373					
30		1976-95	REC396351	140	1985-94	REC5006373					
33		1962-70	REC87607	150 V6	1978-86	REC5006373					
35		1955-59	REC87607	150	1991-95	REC5006373					
35		1977-92	REC396351	155 Comm.	1984-93	REC5006373					
40		1960-73	REC87607	175 V6	1977-86	REC5006373					
Cambio manual Manual shift Cambio manuale Changement manuel		1976-88	REC396355	175	1991-Up	REC5006373					
40		1989	REC433550	185	1991-93	REC5006373					
48		1976-88	REC396355	200 V6	1976-86	REC5006373					
48		1989, 92-93	REC433550	200	1991-Up	REC5006373					
50		1971-74	REC87622	V6	1979-92	REC5006373					
50		1976-88	REC396355	225	1991-95	REC5006373					
50		1989	REC433550	235 V6	1977-86	REC5006373					
55		1976-88	REC396355	V8	1985-91	REC5006373					
60 Elect.		1960-68	REC87608	250 V8	1991-95	REC5006373					
60 2-Cyl.		1976-88	REC396355	300 V8	1991-95	REC5006373					
60 3-Cyl.		1978-01	REC5000309	OMC							
65 Elect.		1960-68	REC87608	1.6 L	1985-90	REC5006373					
65		1978-01	REC5000309	1.8 L	1987	REC5006373					
70		1978-01	REC5000309	2.0 L	1988-90	REC5006373					
75 Elect.		1960-68	REC87608	2.5 L	1984-85	REC5006373					
75		1978-01	REC5000309	2.6 L	1984-86	REC5006373					
75		1978-01	REC5000309	2.7 L	1987	REC5006373					
75		1976-88	REC396355	3.0 L	1988-90	REC5006373					
Cola pequeña Small housing Gambo corto Courte		1978-84	REC5006373	3.6 L	1987	REC5006373					
V4		1968	REC87608	4.0 L	1989-90	REC5006373					
85 Elect.											

SISTEMA DE PROPULSIÓN PROPULSION SYSTEM

SISTEMA DI PROPULSIONE SYSTEME DE PROPULSION

HÉLICES ALUMINIO E
INOXIDABLE
DE 3 Y 4 PALAS

3 & 4 BLADE
ALUMINIUM & SS
PROPELLERS

ELICHE ALLUMINIO E
INOX DA 3 E 4 PALE

HELICE ALUMINIUM ET
INOX 3 ET 4 PALES

CÓDIGO DE REFERENCIAS

PART NO. CODING SYSTEM

SISTEMA DI CODICE

CODAGE DES REFERENCES

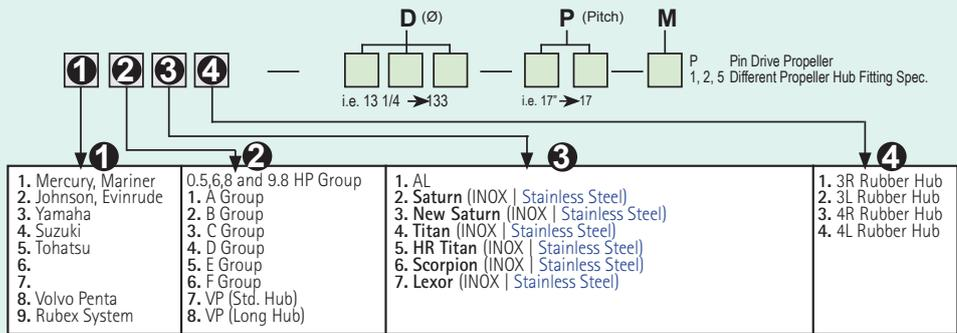

SOLAS

AMITA 3

SOLAS

Hélice de aluminio con núcleo de goma de gran resistencia.

Aluminum propeller with heavy duty rubber hub.

Eliche di alluminio con mozzi in gomma ad alta resistenza.

Hélice en aluminium avec moyeu en caoutchouc



AMITA 4

SOLAS

Hélices de aluminio con núcleo de goma de gran resistencia. Van muy suaves a poca velocidad y hace el barco muy manejable con la mar picada.

Aluminum propeller with heavy duty rubber hub. Smoother low speed makes the offshore boating activity much easier.

Eliche di alluminio con mozzo in gomma ad alta resistenza. Molto morbido a bassa velocità e rende la barca molto gestibile con mare cattivo.

Hélice en aluminium avec moyeu en caoutchouc. Permet d'aller doucement à basse vitesse et rend le bateau très maniable lorsque la mer est agitée



TITAN

SOLAS

Hélices de acero inox. Diseño de pala grande para un área más grande. Gran capacidad de transporte de carga. Excelente economía de combustible.

Stainless steel propeller. High camber blade and large blade area design. Great load carrying capability. Excellent fuel economy.

Eliche in acciaio inossidabile. Ampia capacità di carico. Eccellente riduzione consumo del carburante.

Hélice en acier inox. Pale à carrossage élevé et conception à grande surface de pale. Grande capacité de charge. Excellente économie de carburant.



NEW SATURN

SOLAS

Hélices de acero inoxidable. Ofrece buena aceleración y rendimiento. Tamaño más pequeño que ofrece un diámetro extragrande.

Stainless steel propeller. Offers good acceleration & all-round performance. Smaller pitch sizes offered in extra large diameter with increased blade area.

Eliche di acciaio inox. Buona accelerazione. Piccola dimensione che offre un più grande diametro.

Hélice inox, offrant de bonnes accélérations et performances. Taille de pas réduite pour les modèles de grands diamètres avec une surface de pale plus importante.



HR TITAN 3 PROP

SOLAS

Hélice de acero inoxidable. Alto rendimiento para cascos de alta velocidad. La inclinación de la hoja proporciona un excelente elevación de proa y aceleración. El diseño de copa grande aumenta la mordida y reduce el deslizamiento.

Stainless steel propeller. Performance prop for high speed planning hulls. High rake blade design provides excellent bow lift and acceleration. Heavy cup design increases bite and reduces slip.

Eliche in acciaio inox. Alte prestazioni per scafi ad alta velocità. Il passo della pala fornisce un'eccellente spinta e accelerazione. Il disegno aumenta le prestazioni.

Hélice en inox, haute performance pour les coques à grande vitesse. L'inclinaison des pales offre une excellente portance et une meilleure accélération. La conception des grandes pales augmente la morsure et réduit le glissement.



**GUÍA DE HÉLICES
CON NÚCLEO INTEGRADO**

**PROPELLERS APPLICATION
WITH RUBBER HUB**

**GUIDA ELICHE
CON MOZZO**

**GUIDE DES HELICES ET
MOYEUR**

	R.O. OEM						AL		INOX STAINLESS STEEL			
		AMITA 3		AMITA 4		NEW SATURN	TITAN	HR TITAN 3				
2.5, 3.5 HP	48-815083	3	7 ^{1/4"}	6	R	PLAST.	SOL0001-073-06P					
4, 4.5, 6, 7.5, 8 HP (2 T / Strokes)		3	8	7	R	AL	SOL2011-080-07					
5, 6 HP (4 T / Strokes)		3	8,5	9			SOL2011-085-09					
	398126		10	7			SOL2111-093-07					
9.9 HP (2 Et 4 T / Strokes)	174938		9 ^{1/4"}	8			SOL2111-093-08					
15 HP (2 Et 4 T / Strokes) Thru-Hub		13	3	9	R	AL	SOL2111-093-09					
8 HP (4 T / Strokes)	174950		9	10			SOL2111-093-10					
	174817		9	11			SOL2111-093-11					
	5033200			7			SOL4111-093-07A					
	5005383			8			SOL4111-093-08A					
9.9, 15 HP (4 T / Strokes)	5005384	10	3	9 ^{1/4"}	9	R	AL	SOL4111-093-09A				
	5005385			10			SOL4111-093-10A					
	5033203			11			SOL4111-093-11A					
20, 25, 35 HP 15, 30 HP (Incluye / Include / incluso E-TEC) Thru-Hub	386317		3	11	9							
	175190		3	10 ^{1/2}	11		SOL2211-105-11					
	176424	14	4	10 ^{1/2}	12	R	AL	SOL2211-103-12				
	175191		4	10	13		SOL2211-101-13					
	176425		4	10 ^{1/4}	14		SOL2211-100-14					
	5032107			10 ^{1/2}	11		SOL4211-105-11					
25, 30 HP (4 T / Strokes)	5032108	10	3	10 ^{1/4}	12	R	AL	SOL4211-103-12				
	5032109			10 ^{1/4}	13		SOL4211-101-13					
	5032110			10 ^{1/4}	14		SOL4211-100-14					
	386909			12 ^{1/2}	13		SOL2311-125-13					
40, 48, 50, 55, 60, 65, 75 HP Thru-Hub		13	3	12 ^{1/2}	14	R	AL	SOL2311-125-14				
	176421			12 ^{1/4}	15		SOL2311-123-15					
	176422			11 ^{3/4}	17		SOL2311-120-17					
	5031622			11 ^{1/2}	10		SOL4311-120-10					
	5031623			11 ^{1/2}	11		SOL4311-118-11					
40, 50 HP (4 T / Strokes)	5031624	13	3	11 ^{5/8}	12	R	AL	SOL4311-116-12				
	5031619			11 ^{1/2}	13		SOL4311-116-13					
	5031620			11 ^{3/8}	14		SOL4311-116-14					
	382761			14	11		SOL2411-140-11					
	391668			14	13		SOL2411-138-13	SOL2413-133-13				
40, 45, 50, 55, 60, 65 HP Comercial	391198			13 ^{3/4}	15	R	AL	SOL2411-135-15	SOL2413-130-15	SOL2431-135-15		
	176214	13	3	14	17		SOL2411-133-17	SOL2413-128-17	SOL2431-133-17			
	176215			14	19		SOL2411-130-19	SOL2413-125-19	SOL2431-130-19			
70, 75, 80, 85, 88, 90, 100, 110, 112, 115, 120, 125, 130, 135, 140 E-TECH (2 Et 4 T / Strokes)	176216			14	21		SOL2411-130-21	SOL2413-125-21	SOL2431-130-21			
	389949			13 ^{3/4}	15				SOL2431-135-15			
	389948			13 ^{3/8}	17	R	INOX / SS		SOL2431-133-17			
	389510	13	3	13	19				SOL2431-130-19			
	389512			12 ^{3/4}	21				SOL2431-130-21			

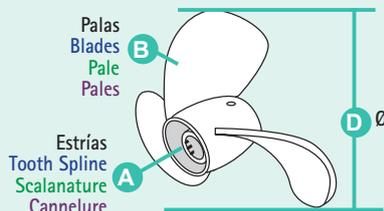

- P** Paso
Pitch
Passo
Pas
- R** Rotación L (izquierda) R (derecha)
Rotation L (left) R (Right)
Rotazione L (SX) R (DX)
Rotation L (gauche) R (droit)

	R.O. OEM	A B D P R					AL		INOX STAINLESS STEEL			
							AMITA 3	AMITA 4	NEW SATURN	TITAN	HR TITAN 3	
90, 115, 140 HP (4 T / Strokes)	5033322			13 ^{1/2}	15	R		SOL3413-138-15				
	5033323			14	17	R		SOL3413-138-17			SOL3451-139-17	
	5033324	15	3	14	19	R	AL	SOL3413-138-19			SOL3451-139-19	
	5033325			14	21	R		SOL3413-138-21			SOL3451-139-21	
	5033326			14	23	R					SOL3451-139-23	
	5033327			14	18	R					SOL3451-139-17	
	5033955			14	18	L					SOL3452-139-17	
	5033328			14	20	R					SOL3451-139-19	
	5033956	15	3	14	20	L	INOX / SS				SOL3452-139-19	
	5033329			14	22	R					SOL3451-139-21	
	5033957			14	22	L					SOL3452-139-21	
	5033330			14	24	R					SOL3451-139-23	
	90, 100, 115, 130, 150 HP 120-140 / V4 V6 Gear Case 135, 150, 155, 175, 185, 200, 225, 235, 250 2.6 L / V6 E-TEC	391535			15 ^{1/2}	15	R		SOL2511-150-15	SOL2513-148-15	SOL2531-145-15	
				15	15	L		SOL2512-150-15	SOL2514-148-15	SOL2532-145-15		
391200				15	17	R		SOL2511-148-17	SOL2513-145-17	SOL2531-143-17		
				17	17	L		SOL2512-148-17	SOL2514-145-17	SOL2532-143-17		
391201				14 ^{1/2}	19	R		SOL2511-145-19	SOL2513-143-19	SOL2531-140-19		
				19	19	L		SOL2512-145-19	SOL2514-143-19	SOL2532-140-19		
391202				14 ^{1/2}	21	R		SOL2511-143-21	SOL2513-140-21	SOL2531-140-21		
				21	21	L		SOL2512-143-21	SOL2514-140-21	SOL2532-140-21		
391203				14 ^{1/2}	23	R		SOL2511-142-23		SOL2531-140-23		
				23	23	L				SOL2532-140-23		
Non-SX Drive 100-150 Comercial V6 Gear Case 150, 155, 175, 200, 225, 250, 275, 300, 3.6L / V8		390831			15 ^{1/2}	14	R					
		174926			15	15	R				SOL2531-145-15	
		174927			15	15	L				SOL2532-145-15	
	391290			15	17	R				SOL2531-143-17		
	431930			15	17	L				SOL2532-143-17		
Non-SX Drive E-TEC	389924	15	3	14 ^{1/2}	19	R	INOX / SS			SOL2531-140-19		
	390821			14 ^{1/2}	19	L				SOL2532-140-19		
	389923			14 ^{1/4}	21	R				SOL2531-140-21		
	390822			14 ^{1/4}	21	L				SOL2532-140-21		
	289019			14 ^{1/4}	23	R				SOL2531-140-23		
	390823			14 ^{1/4}	23	L				SOL2532-140-23		
200, 225 HP (4 T / Strokes)				15.8	15	R		SOL4511-150-15				
				15.8	15	L		SOL4512-158-15				
				15.5	17	R		SOL4511-155-17				
				15.5	7	L		SOL4512-155-17				
				15 ^{3/8}	18	R					SOL4571-154-18	
				15 ^{3/8}	18	L					SOL4572-154-18	
				15.3	19	R		SOL4511-153-19				
			15	3	15.3	19	L	AL	SOL4512-153-19			
				15 ^{1/8}	20	R					SOL4571-151-20	
				15 ^{1/8}	20	L					SOL4572-151-20	
				15.3	21	R		SOL4511-153-21				
				15.3	21	L		SOL4512-153-21				
				14 ^{7/8}	22	R					SOL4571-149-22	
			14 ^{7/8}	22	L					SOL4572-149-22		
			14 ^{3/4}	23	R					SOL4571-148-23		
			14 ^{3/4}	23	L					SOL4572-148-23		

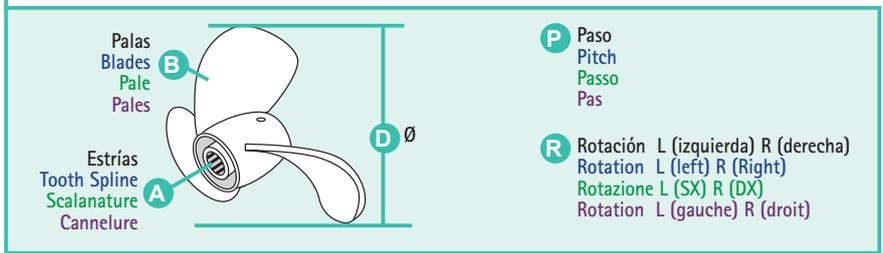

NÚCLEO INTERCAMBIABLE INTERCHANGEABLE HUB

MOZZO INTERCAMBIABILE

MOYEU INTERCHANGEABLE

	2T STROKES	4T STROKES	A		REF	
45-75 HP Cola pequeña Small gearcase <i>Piede piccolo</i> <i>Embase courte</i>				3 ^{3/8"}	SOLRBX-111	C
45-75 HP Cola larga Large gearcase <i>Piede lungo</i> <i>Embase Longue</i>			13		SOLRBX-106	D
85-140 HP Cola larga Large gearcase <i>Piede lungo</i> <i>Embase Longue</i>			13	4 ^{1/4"}	SOLRBX-106	D
60 & 70 HP		✓	13		SOLRBX-110	D
90, 115 HP		✓	15		SOLRBX-125	D
140 HP		✓	15		SOLRBX-126	D
90, 140 HP Cola larga Large gearcase <i>Piede lungo</i> <i>Embase Longue</i>			15		SOLRBX-101	E
90, 140 HP Cola larga Large gearcase <i>Piede lungo</i> <i>Embase Longue</i>			15		SOLRBX-100	E
150-300 HP			15		SOLRBX-101	E
150-300 HP			15		SOLRBX-100	E

RUBEX



HÉLICES PARA NÚCLEO INTERCAMBIABLE

PROPELLERS FOR INTERCHANGEABLE HUB

ELICHE PER MOZZO INTERCAMBIABILE

HELICES AVEC MOYEU INTERCHANGEABLE

	B	D	P	R	AL
C 30-75 HP	3	11.4	12	R	SOL9311-114-12
		11.1	13	R	SOL9311-111-13
		14	9	R	SOL9411-140-09
D 40-140 HP	3	14	11	R	SOL9411-140-11
		13.75	13	R	SOL9411-138-13
		13.5	15	R	SOL9411-135-15
		13.25	17	R	SOL9411-133-17
		13.2	19	R	SOL9411-132-19
		13.2	21	R	SOL9411-132-21
E 135-350 HP	3	15.5	11	R	SOL9511-155-11
		16	13	R	SOL9511-160-13
		15.3	13	R	SOL9511-153-13
		15	15	R	SOL9511-150-15
		15	15	L	SOL9511-150-15
		14.8	17	R	SOL9511-148-17
		14.8	17	L	SOL9511-148-17
		14.5	19	R	SOL9511-145-19
		14.5	19	L	SOL9511-145-19
		14.3	21	R	SOL9511-143-21
14.3	21	L	SOL9511-143-21		

	B	D	P	R	INOX STAINLESS STEEL
D 40-140 HP	3	13 ^{3/4}	13	R	SOL9431-138-13
		13 ^{3/4}	13	L	SOL9432-138-13
		13 ^{1/2}	15	R	SOL9431-135-15
		13 ^{1/2}	15	L	SOL9432-135-15
		13 ^{1/4}	17	R	SOL9431-133-17
		13 ^{1/4}	17	L	SOL9432-133-17
		13	19	R	SOL9431-130-19
		13	19	L	SOL9432-130-19
		13	21	R	SOL9431-130-21
		13	21	L	SOL9432-130-21
E 90-140 HP	3	14 ^{1/2}	15	R	SOL9531-145-15
		14 ^{1/2}	15	L	SOL9532-145-15
		14 ^{1/4}	17	R	SOL9531-143-17
		14 ^{1/4}	17	L	SOL9532-143-17
		14	19	R	SOL9531-140-19
		14	19	L	SOL9532-140-19
		14	21	R	SOL9531-140-21
		14	21	L	SOL9532-140-21
		14	23	R	SOL9531-140-23
		14	23	L	SOL9532-140-23
E 135-350 HP	3	15 ^{3/4}	15	R	SOL9571-158-15
		15 ^{3/4}	15	L	SOL9572-158-15
		15 ^{1/2}	17	R	SOL9571-155-17
		15 ^{1/2}	17	L	SOL9572-155-17
		15 ^{1/4}	19	R	SOL9571-153-19
		15 ^{1/4}	19	L	SOL9572-153-19
		15	21	R	SOL9571-150-21
		15	21	L	SOL9572-150-21
		14 ^{3/4}	23	R	SOL9571-148-23
		14 ^{3/4}	23	L	SOL9572-148-23

RUBEX



Núcleo intercambiable (no incluido).
Interchangeable hub (not included).
Mozzo intercambiabile (non incluso).
Moyeu interchangeable (non inclus)



PIEZAS HÉLICE

PROP PARTS

PARTI ELICA

PIECES D'HÉLICE

TUERCA DE HÉLICE

PROPELLER NUT

DADO DI ELICA

ÉCROU D'HÉLICE

REF	OEM	Icon
REC09141-12005	5032950	J10, 15 HP



new

REF	OEM	Icon
REC90171-18M04	09141-18005	40 --> 250 HP



new

REF	OEM	Icon
REC314503	314503	5/8" NC 11
REC318971	318971	7/16" NC14
REC319891	319891	1/2" NC13



PASADOR

PIN

SPINOTTO

GOUPILLE FENDUE

REF	OEM	Icon
REC314502	314502	
REC3852056	3852056	
REC18-32665	302804	
REC309955	309955	
REC320785	320785	
REC328522	552906	



REF	OEM	Icon
REC09204-02004	5032996	J10, 15 HP



new

REF	OEM	Icon
REC91490-30025	5030087	4 --> 225 HP



new

REF	OEM	Icon
PAGB/T91-1.6X12	5037363 5037373	J10, 15 HP



new

SEPARADOR DE HÉLICE

PROPELLER WASHER

DISTANZIALE ELICA

ENTRETOISE D'HELICE

REF	OEM	Icon
REC57632-94J00	5033197	J10, 15 HP



new

REF	OEM	Icon
REC57633-93901	5033198	J10, 15 HP



new

PASADOR DE HÉLICE

PROPELLER PIN

PIN ELICA

CLAVETTE D'HELICE

REF	OEM	Icon
REC09202-04002	5030084	J2, 4, 5 HP



new

TOPE HÉLICE

THRUST WASHER

RONDELLA CHIUSSURA

RONDELLE DE BUTÉE

REF	OEM	GROSOR THICK SPESSORE ÉPAISSEUR	Ø EXT	
REC320305	320305	15/32"	2 1/8"	
REC127084	127084	19/32"	2 9/16"	
REC126870	3852020	3/4"	2 7/8"	"O", "M" (1991+)
REC319890	319890	3/8"	1 3/4"	2 Cyl. Crossflow 20-35 HP
REC334590	334590	5/8"	1 1/2"	9.9 - 15 HP (1989+)



REF	OEM		Ø EJE Ø SHAFT Ø ASSE Ø ARBRE
REC315810	315810	13	7/8"
REC320570	320570	15	1"
REC323942	323942	13	5/8"
REC323943	323943	14	13/16"



GUÍA DE RECAMBIOS DE HÉLICE

PROPELLER SPARE PARTS

GUIDA RICAMBIO ELICHE

GUIDE DES PIÈCES POUR HÉLICE

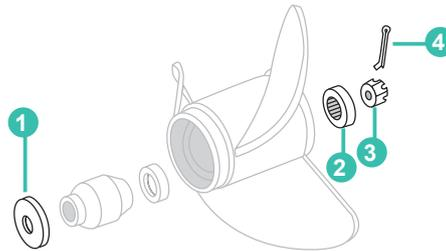

	1	2	3	4	KIT	
9.9/15	1974-78		REC323942	REC318971	REC328522	REC175269
9.9/15	1989	REC334590	REC323942	REC318971	REC328522	REC175269
20	1985	REC319890	REC323943	REC319891	REC320785	REC175268
25	1985	REC319890	REC323943	REC319891	REC320785	REC175268
30	1985	REC319890	REC323943	REC319891	REC320785	REC175268
35	1976	REC319890	REC323943	REC319891	REC320785	REC175268
40	1984	REC320305	REC315810	REC314503	REC314502	REC175267
45	1985	REC320305	REC315810	REC314503	REC314502	REC175267
48	1987	REC320305	REC315810	REC314503	REC314502	REC175267
50	1972-74	REC127084	REC315810	REC314503	REC314502	REC175267
50	1975-76	REC320305	REC315810	REC314503	REC314502	REC175267
50	1979	REC320305	REC315810	REC314503	REC314502	REC175267
50	1981	REC320305	REC315810	REC314503	REC314502	REC175267
50	1982	REC320305	REC315810	REC314503	REC314502	REC175267
55	1977-79	REC127084	REC315810	REC314503	REC314502	REC175267
55	1981	REC320305	REC315810	REC314503	REC314502	REC175267
55	1983	REC127084	REC315810	REC314503	REC314502	REC175267
55	1985	REC127084	REC315810	REC314503	REC314502	REC175267
60	1971	REC127084	REC315810	REC314503	REC314502	REC175267
60	1980	REC320305	REC315810	REC314503	REC314502	REC175267
65	1972-73	REC127084	REC315810	REC314503	REC314502	REC175267
65 Comm.	1984	REC127084	REC315810	REC314503	REC314502	REC175267
70 (15")	1979-85	REC320305	REC315810	REC314503	REC314502	REC175267
70 (20")	1974-94	REC127084	REC315810	REC314503	REC314502	REC175267
75 (15")	1975-88	REC320305	REC315810	REC314503	REC314502	REC175267
75 (20")	1975-87	REC127084	REC315810	REC314503	REC314502	REC175267
85	1971-80	REC127084	REC315810	REC314503	REC314502	REC175267
88	1987-94	REC127084	REC315810	REC314503	REC314502	REC175267

		1	2	3	4	KIT
90	1981-94	REC127084	REC315810	REC314503	REC314502	REC175267
100	1971-72	REC127084	REC315810	REC314503	REC314502	REC175267
100	1979-94	REC127084	REC315810	REC314503	REC314502	REC175267
100 Comm.	1984		REC320570	REC5008966 REC398042	REC3852056	REC175266
110	1987-94	REC127084	REC315810	REC314503	REC314502	REC175267
115	1973-94	REC127084	REC315810	REC314503	REC314502	REC175267
120	1985		REC320570	REC5008966 REC398042	REC3852056	REC175266
120	1986-94	REC127084	REC315810	REC314503	REC314502	REC175267
125	1971-72	REC127084	REC315810	REC314503	REC314502	REC175267
135	1973-76	REC127084	REC315810	REC314503	REC314502	REC175267
140	1977-84	REC127084	REC315810	REC314503	REC314502	REC175267
140	1985		REC320570	REC5008966 REC398042	REC3852056	REC175266
140	1986-94	REC127084	REC315810	REC314503	REC314502	REC175267
150	1978-90		REC320570	REC5008966 REC398042	REC3852056	REC175266
150	1991	REC126870	REC320570	REC5008966 REC398042	REC3852056	REC175266
155 Comm.	1984-90		REC320570	REC5008966 REC398042	REC3852056	REC175266
155 Comm.	1991	REC126870	REC320570	REC5008966 REC398042	REC3852056	REC175266
175	1977-90		REC320570	REC5008966 REC398042	REC3852056	REC175266
175	1991	REC126870	REC320570	REC5008966 REC398042	REC3852056	REC175266
185	1984-90		REC320570	REC5008966 REC398042	REC3852056	REC175266
185	1991	REC126870	REC320570	REC5008966 REC398042	REC3852056	REC175266
200	1986-90		REC320570	REC5008966 REC398042	REC3852056	REC175266
200	1991	REC126870	REC320570	REC5008966 REC398042	REC3852056	REC175266
225	1986-90		REC320570	REC5008966 REC398042	REC3852056	REC175266
225	1991	REC126870	REC320570	REC5008966 REC398042	REC3852056	REC175266
235	1976-90		REC320570	REC5008966 REC398042	REC3852056	REC175266
275	1985-90		REC320570	REC5008966 REC398042	REC3852056	REC175266
275	1991	REC126870	REC320570	REC5008966 REC398042	REC3852056	REC175266
3.6 L	1985-90		REC320570	REC5008966 REC398042	REC3852056	REC175266
300	1991	REC126870	REC320570	REC5008966 REC398042	REC3852056	REC175266
1.6 Seadrive	1982-90	REC127084	REC315810	REC314503	REC314502	REC175267
2.5 L Seadrive	1984-90		REC320570	REC5008966 REC398042	REC3852056	REC175266
2.6 L Seadrive	1982-90		REC320570	REC5008966 REC398042	REC3852056	REC175266

KIT CIERRE HÉLICE		PROP NUT KITS		KIT CHIUSURA ELICA		KIT ÉCROU D'HÉLICE	
REF	OEM	4T STROKES	2T STROKES	REF	OEM	4T STROKES	2T STROKES
REC57630-96300	5032170	E25 / E30 / J25 / J30 BJ25 (2000-07)	✓	REC57630-94500	5030976	E60 / J60 / BJ60 E70 / J70 / BJ70 (1998-04)	✓
REF	OEM	4T STROKES	2T STROKES	REF	OEM	4T STROKES	2T STROKES
REC57630-94300	5031548	E40 / J40 / BJ40 E50 / J50 / BJ50 (1999-06)	✓	REC57630-92E00	5035460	J200 / J225 BJ200 / BJ225 (2004-06)	✓

REF	OEM		4T STROKES	2T STROKES
REC386866	386866		2 Et 3 Cyl. (1972+) Small	



REF	OEM		4T STROKES	2T STROKES
REC5005034	5005034		2 Et 3 Cyl. (1975+) Large V4 (1973+) Small	



REF	OEM		4T STROKES	2T STROKES
REC414153	434153		V4 / V6 "0" (1976-90) Large	



REF	OEM		4T STROKES	2T STROKES
REC22186			V4 / V6 / V8 "0" (1991+) Large	



**KIT CIERRE HÉLICE
SIN ARANDELA**

**PROP NUT KITS
WITHOUT WASHER**

**KIT CHIUSURA ELICA
SENSA RONDELLA**

**KIT ÉCROU D'HÉLICE
SANS RONDELLE**

REF	OEM	
REC175269	175269	9.9 - 15 HP

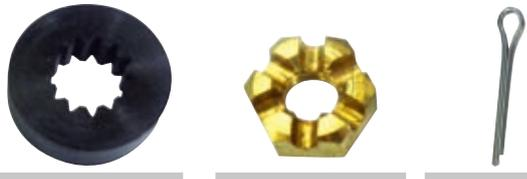

REF	OEM	REF	OEM	REF	OEM
REC323942	323942	REC318971	318971	REC328522	328522

REF	OEM	
REC175268	175268	2 Cyl. Crossflow 20 - 35 HP (1980-05)



REF	OEM	REF	OEM	REF	OEM
REC323943	323943	REC319891	319891	REC320785	320785

REF	OEM
REC175267	175267



REF	OEM	
REC398042	398042	3/4" NF 16



REF	OEM
REC175266	175266



GUÍA DE KITS DE
RECAMBIOS DE CIERRE

PROPELLER KITS &
HARDWARE APPLICATIONS

GUIDA RICAMBI
CHIUSURA ELICHE

GUIDE DES KITS ET PIÈCES
POUR HÉLICE

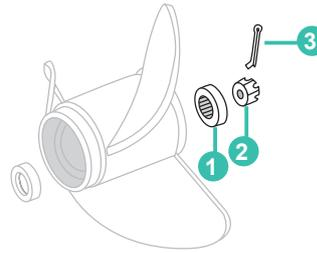

		1	1	2	3	KIT	KIT +
9.9 - 15 HP	1974-88		REC323942	REC318971	REC328522	REC175269	
9.9 - 15 HP	-1989	REC334590	REC323942	REC318971	REC328522	REC175269	
2 Cyl. Crossflow 20-35 HP, Thru-prop exhaust	1980-05	REC319890	REC323943	REC319891	REC320785	REC175268	
2-Cyl. Loopcharged, 40-60 HP	1972-85	REC320305	REC315810	REC314503	REC314502	REC175267	REC386866
2-Cyl. Loopcharged, 40-60 HP small	1986-88	REC320305	REC315810	REC314503	REC314502	REC175267	REC386866
2-Cyl. Loopcharged, 40-60 HP large	1986-88	REC127084	REC315810	REC314503	REC314502	REC175267	REC5005034
2-Cyl. Loopcharged, 40-50 hp	1989-05	REC320305	REC315810	REC314503	REC314502	REC175267	REC386866
2-Cyl. Loopcharged, 55 hp	1989-05	REC127084	REC315810	REC314503	REC314502	REC175267	REC5005034
3-Cyl., 65 + 70 HP	1972-74	REC320305	REC315810	REC314503	REC314502	REC175267	REC386866
3-Cyl., 65, 70, 75 HP small	1975-88	REC320305	REC315810	REC314503	REC314502	REC175267	REC386866
3-Cyl., 65, 70, 75 HP large	1975-88	REC127084	REC315810	REC314503	REC314502	REC175267	REC5005034
3-Cyl., 60, 65, 70 HP	1989-01	REC127084	REC315810	REC314503	REC314502	REC175267	REC5005034
3-Cyl., 25, 30, 35 HP	1996-01		REC323943	REC319891	REC320785		
V4, Ø 7/8" 13 estriás spline scalanature Cannelure	1973	REC127084	REC315810	REC314503	REC314502	REC175267	REC5005034
V4, Ø 1" 15 estriás spline scalanature Cannelure	1984-90		REC320570	REC398042	REC3852056	REC175266	REC414153
V4, Ø 1" 15 estriás spline scalanature Cannelure	1991	REC126870	REC320570	REC398042	REC3852056	REC175266	REC22186
V6 / V8	1976-90		REC320570	REC398042	REC3852056	REC175266	REC414153
V6 / V8	1991	REC126870	REC320570	REC398042	REC3852056	REC175266	REC22186

REF --> RO / OEM

REF	R.O. / OEM	REF	R.O. / OEM	REF	R.O. / OEM
C					
CEF500303C	439	CM984547	984547	PAGB/T91-1.6X12	5037373 548
CEF500305	439	CM984547A	983952	PAGB/T93-6	5030068 499-505
CEF500306	439	CM984547A	984547	PAGB/T97.1-8	
CEF500306C	439	CMOMC5075KITA	457	PH130-0006	5040786 405
CEF500307	439	CMOMCV4V6KITA	457	PH130-0008	391511 408
CEF500345	439			PH130-0008	397023 408
CEF500350	439			PH130-0008	396235 408
CEF500351	439			PH130-0008	584799 408
CEF500352	439			PH130-0008	586890 408
CEF500353	439-453			PH130-0008	384799 408
CEF500354G	439			PH130-0008	586289 408
CEF500355	439			PH130-0008	586411 408
CEF500358	439			PH130-0008	586731 408
CEF500370C	439			PH130-0008	586897 408
CEF500370C	439			PH130-0008	586957 408
CEF500372C	439			PH130-0012	393570 407
CHAJ8C	401-403			PH130-0012	585600 407
CHAL77JC4	401-402-403-404			PH130-0012	586285 407
CHAL78YC	401-402-403-404			PH130-0012	778994 407
CHAL82C	401-402-403-404			PH130-0013	584608 405
CHAL87YCC	401-403			PH130-0013	586275 405
CHAPROSL	405			PH130-0014	386430 405
CHAQL16V	402			PH130-0014	586276 405
CHAQL77JC4	401-402-403-404			PH130-0016	583482 406
CHAQL78YC	401-402-403-404			PH130-0016	585056 406
CHAQL82C	401-402-403-404			PH130-0016	586279 406
CHAQL87YC	401-403			PH130-0017	5583473 406
CHARA8HC	401-403			PH130-0017	585059 406
CHARJ8C	401-403			PH130-0017	778991 406
CHAUL77V	401-402-403-404			PH130-0018	432925 407
CHAUL81C	401-402-403-404			PH130-0018	586286 407
CHAXC12PEPB	402-404			PH130-0018	586287 407
CM11130-94600	462			PH130-0026	586277 406
CM123009	123009			PH130-0026	584818 406
CM123009	173029			PH130-0026	778996 406
CM123009A	173029			PH130-0027	584980 407
CM327606	327606			PH130-0027	586284 407
CM327606A	327606			PH130-0032	438878 407
CM334451	334451			PH130-0032	586257 407
CM334451A	432397			PH130-0035	586768 405
CM334451A	334451			PH130-0035	587045 405
CM334451A	432397			PH130-0038	386591 405
CM338635	338635			PH130-0038	392133 405
CM338742	338742			PH130-0038	585061 405
CM389999	389999			PH130-0038	586278 405
CM389999A	389999			PH130-0038	277432 405
CM392123	392123			PH130-0038	278232 405
CM392123A	392123			PH130-0038	378674 405
CM392462	392462			PH130-0038	379091 405
CM392462A	392462			PH130-0038	379818 405
CM393023	393023			PH130-0038	380139 405
CM393023A	393023			PH130-0038	380238 405
CM397768	397768			PH130-0038	381864 405
CM397768A	397768			PH130-0038	385401 405
CM398873	398873			PH130-0038	386597 405
CM398873A	398873			PH130-0039	387094 407
CM431708	431708			PH130-0039	395207 407
CM431708A	431708			PH130-0039	585062 407
CM433458	433458			PH130-0039	586288 407
CM433458A	398331			PH130-0039	778992 407
CM433458A	433458			PH130-0039	777693 407
CM434029	434029			PH130-0043	383691 406
CM5007089	5007089			PH130-0043	384777 406
CM5007089A	5007089			PH130-0043	386657 406
CM5031538	5031538			PH130-0043	391735 406
CM5031705	5031705			PH130-0043	585058 406
CM5032929	5032929			PH130-0043	585197 406
CM5032930	5032930			PH130-0043	586281 406
CM5033167	5033167			PH130-0044	385529 407
CM55125-95500	5031536			PH130-0044	389954 407
CM55300-95500	5031538			PH130-0044	585057 407
CM55320-98600	5030267			PH130-0044	585196 407
CM55321-87J00	5031705			PH130-0044	586282 407
CM55321-90J01AL	5032930			PH130-0044	586283 407
CM55321-93900	5033185			PH130-0044	386465 407
CM976669	976669			PH130-0044	389380 407
CM976669A	976669			PH130-0044	391554 407
CM980756	980756			PH130-0045	585051 407
CM980756A	980756			PH130-0045	384163 406
CM982438	982438			PH130-0045	387684 406
CM982438	982438			PH130-0045	389275 406
CM983494	983494			PH130-0045	585063 406
CM983494A	983494			PH130-0045	586280 406
CM984513	984513			PH130-0045	778993 406
CM984513A	984513			PH130-0061	5040343 405
CM984547	983952			PH130-0071	5033799 407
				PH130-0077	5036972 406
				PH130-0078	5035078 408
				PH130-0079	5030780 409
				PH200-T004	439937 425
				PH200-T004	5005254 425
				PH200-T004	438786 425
				PH200-T005	434495 424
				PH200-T005	434496 424
				PH200-T005	438529 424
				PH200-T005	5005374 424
				PH200-T005	438531 424
				PH200-T014	391264 423
				PH200-T014	393259 423
				PH200-T014	393988 423
				PH200-T014	394176 423
				PH200-T014	983019 423
				PH200-T020	387277 423

REF	R.O. / OEM		REF	R.O. / OEM		REF	R.O. / OEM	
PH200-T020	582048	423	REC0176408	176408	429	REC0583672	583023	419
PH200-T020	582155	423	REC0319661	319661	485	REC0583672	583104	419
PH200-T020	584107	423	REC0319662	319662	445	REC0583672	583671	419
PH200-T020	582047	423	REC0321479	321479	486	REC0583672	583672	419
PH200-T020	777784	423	REC0323327	0323327	398	REC0583672	581030	419
PH200-T021	437801	424	REC0324323	3234323	482	REC0583672	581987	419
PH200-T021	435532	424	REC0326260	326260	486	REC0583672		421-422
PH200-T022	433226	424	REC0326264	326264	482	REC0583689	583266	413
PH200-T046	5032670	424	REC0326877	326877	408	REC0583689	583689	413
PH200-T061	5006319	425	REC0329319	329319	436	REC0583689	586000	413
PH200-T061	5005838	425	REC0330621	330621	480	REC0583689	5844241	413
PH200-T061	5005817	425	REC0334665	334665	466	REC0583689		414
PH200-T062	5036081	424	REC0340975	340975	455	REC0583724	581957	418
PH200-T062	5032670	424	REC0340976	340976	455	REC0583724	582506	418
PH200-T062	5031482	424	REC0385008	384461	417	REC0583724	582730	418
PH200-T072	5005822	424	REC0385008	385008	417	REC0583724	583119	418
PH200-T072	5005831	424	REC0395204	395204	412	REC0583724	583644	418
PH200-T072	5005875	424	REC0395204	395391	412	REC0583724	583724	418
PH200-T072	5006479	424	REC0395204	582904	412	REC0583724		421
PH200-WH01	84-819514T26	423	REC0395204		414	REC0583740	583740	400-401
PH200-WH01	84-826075A2	423	REC0395911	395911	430	REC0583748	583748	416-421
PH200-WH01	84-826802A4	423	REC0397004	397004	430	REC0583865	583865	414-421-422
PH350-0001	583408	414	REC0398243	398243	430	REC0584028	583773	415
PH350-0001	582399	414	REC0433325	433325	430	REC0584028	584027	415
PH350-0002	581778	414	REC0435230	435230	430	REC0584028	584028	415
PH350-0003	509219	411	REC0435279	435279	492-493	REC0584028		421
PH375-0012	582708	410	REC0436367	436367	415	REC0584035	583471	414
PH375-0012	395419	410	REC0436367	584122	415	REC0584035	584034	414
PH375-0012	380095	410	REC0439542	439542	430	REC0584035	584035	414
PH375-0012	383622	410	REC0500581	500581	430	REC0584035		422
PH375-0012	389398	410	REC0500581	396161	430	REC0584041	583489	414
PH375-0012	389493	410	REC0502880	581407	400	REC0584041	584040	414
PH375-0012	586180	410	REC0502881	502881	400	REC0584041	584041	414
PH375-0027	586730	410	REC0502881	581786	400	REC0584041		421-422
PH375-0027	586842	410	REC0502881		400	REC0584288	583561	419
PH375-0027	778209	410	REC0502888	582888	400	REC0584288	584288	419
PH375-0027	980801	410	REC0502888	582091	400	REC0584288		421-422
PH375-0027	981703	410	REC0502888		401	REC0584333	583485	418
PH375-0027	982189	410	REC0502890	502890	400	REC0584333	584333	418
PH375-0027	985064	410	REC0502890	582160	400	REC0584477	584477	400
PH375-0027	385389	410	REC0502890	584632	400	REC0584954	584954	418-420
PH375-0029	985063	409	REC0502890		401	REC0584985	584910	415
PH375-0029	892187	409	REC0554545	554545	445-513	REC0584985	584985	415
PH375-0029	98410	409	REC0580148	580148	427	REC0584985	584990	415
PH375-0029	778025	409	REC0580256	580256	426-427	REC0584985		421-422
PH375-0029	584128	409	REC0580290	580290	427	REC0584986	584986	414
PH375-0030	979774	410	REC0580321	580321	426-427	REC0584986	584988	414
PH375-0030	778021	410	REC0581207	581207	427	REC0584986	584912	414
PH375-0033	172869	410	REC0581419	581419	426-427	REC0584986	584989	414
PH375-0033	581528	410	REC0582056	581731	417	REC0584986	584991	414
PH375-0033	777699	410	REC0582056	582056	417	REC0585081	585081	412
PH375-0047	5031483	411	REC0582056		421	REC0585195	583529	413
PH375-0047	5032195	411	REC0582057	582057	417-421-422	REC0585195	584204	413
PH375-0048	5032197	411	REC0582115	582115	416	REC0585195	585195	413
PREMC30506	173106	430	REC0582115	583125	416	REC0585195		414
PREMC30507	173107	430	REC0582115	583143	416	REC0585274	585274	415-421
PREMC30508	173105	430	REC0582115		421	REC0586271	586271	413
PREMC30509	173109	430	REC0582125	582684	416	REC0586271	584641	413
PREMC30510	173110	430	REC0582125	582125	416	REC0586271	585995	413
PREMC30511	173111	430	REC0582125	582454	416	REC0586271		414
PREMC30512	173112	430	REC0582125	581805	416	REC0586343	584265	417
PREMC30513	173113	430	REC0582125		421-422	REC0586343	584914	417
PREMC30514	173114	430	REC0582262	5814014	415	REC0586343	586343	417
PREMC30515	173115	430	REC0582262	582262	415	REC0586343		421-422
PREMC30516	173116	430	REC0582262	583041	415	REC0586661	584636	414
PREMC30517	173117	430	REC0582262	583103	415	REC0586661	584637	414
PREMC30518	173118	430	REC0582262	583336	415	REC0586661	585114	414
PREMC30519	173119	430	REC0582262		421-422	REC0586661	586212	414
PREMC30520	173120	430	REC0582382	582382	401	REC0586661	586661	414
PREMC30521	173121	430	REC0582452	582453	416	REC0586661		422
PREMC30522	173122	430	REC0582452	583380	416	REC0586667	583476	414
PREMC30523	173123	430	REC0582452		420-421	REC0586667	584036	414
PREMC30524	173124	430	REC0582508	582508	400-401	REC0586667	584037	414
R			REC0582642	582138	416	REC0586667	586217	414
RAC120R-RAC-01		386-387	REC0582642	582400	416	REC0586667	586667	414
RAC23289-10		388	REC0582642	582642	416	REC0586667		422
RAC23299-10		388	REC0582642	582556	416	REC0586695	396077	416
RAC320R-INOX-01		387	REC0582642		421-422	REC0586695	582261	416
RAC320R-RAC-01	8M0097838	386-387	REC0582901	582474	416	REC0586695	582504	416
RAC320R-RAC-02		387	REC0582901	582864	416	REC0586695	582714	416
RAC320R-RAC-03	8M0097838	386	REC0582901	582901	416	REC0586695	582800	416
RAC490R-RAC-01		388	REC0582901		421	REC0586695	582889	416
RACPF5510		385	REC0583114	583114	416-421-422	REC0586695	583172	416
RACRK22628		388	REC0583320	583122	416	REC0586695	583174	416
RACS3213		386-387	REC0583320	583320	416	REC0586695	583241	416
RACS3214		387	REC0583387	583387	421	REC0586695	584508	416
RACS3220UL		387	REC0583415	584287	417-420-421	REC0586695	584528	416
RACS3227		387-388	REC0583415	763765	419	REC0586695	584746	416
RACS3228UL		387	REC0583415		421	REC0586695		420-421
RACS3240		386-387	REC0583668	582574	421	REC0586697	396141	416
REC0172522		427	REC0583668	583050	419	REC0586697	582281	416
REC0172523		427	REC0583668	583274	419	REC0586697	582285	416
REC0172525		427	REC0583668	583668	419	REC0586697	582502	416
REC0172806		427	REC0583668	763785	419	REC0586697	582757	416
REC0175316	175316	415	REC0583668		421-422	REC0586697	582880	416
REC0175316	585261	415	REC0583670	582847	418	REC0586697	583167	416
REC0175316	585262	415	REC0583670	583117	418	REC0586697	583168	416
REC0175316		420-421	REC0583670	583670	418	REC0586697	583169	416
REC0176333	176333	430	REC0583670		418	REC0586697	583170	416
REC0176335	176335	430	REC0583672	582016	422	REC0586697	583175	416
REC0176340	176340	430	REC0583672	582497	419	REC0586697	583604	416
REC0176342	176342	430	REC0583672	582867	419	REC0586697		420-421
						REC0586767	0586767	410

REF	R.O. / OEM		REF	R.O. / OEM		REF	R.O. / OEM	
REC0586767	586767	410	REC09282-15008	5036938	489	REC14212-93J00	5034982	482
REC0586798	584783	415-420	REC09282-17005	5031264	489-505	REC15-201		404
REC0763759	584109	419	REC09282-17009	5031266	489	REC15-202		404
REC0763759	584981	419-421-422	REC09283-10003	5030109	489	REC15-203	84-813715A1	404
REC0763760	584849	418	REC09283-10009	5033339	489	REC15-204		404
REC0763760	763760	418	REC09283-20018	5030110	489	REC15170-91J00	5033372	394-395
REC0763760		421	REC09283-20045	5030111	489	REC15170-94J00	5037584	394-395
REC0763763	584560	419	REC09283-25076	5033481	489	REC15170-98110	5030181	394-395
REC0763763	763763	419	REC09289-12003	5033014	499	REC15170-99E00	5030699	394-395
REC0763763		420-421	REC09289-17006	5033015	489-499	REC15410-87J00	5031400	390
REC0763764	583710	419	REC09289-20009	5031893	489-501-503	REC15410-87J10	5032323	389
REC0763764	584292	419	REC09289-22007	5031270	489-505	REC15410-87J10	5030702	389
REC0763764	763764	419	REC09380-15001	5033027	447-499	REC15410-87J30	5035974	389
REC0763764		421-422	REC09420-03002	5030137	441-497	REC15410-93J00	5034984	389
REC0763765	583415	419	REC09420-03005	5033113	441	REC15410-98500	5032238	389
REC0763765	584287	419	REC09420-04006	5031281	441-501-503-505	REC15440-90J00	5033704	391
REC0763765	763765	419	REC09420-05009	5034842	441	REC15440-93J00	5034985	390
REC0763765		422	REC09420-05009	5033632	441	REC15440-99E01	5030706	391
REC0763767	583340	419	REC09420-05009	5084842	441	REC15626-90J00	5033706	394
REC0763767	583536	419	REC09420-05009	5034842	507-508	REC15626-99E00	5031114	394
REC0763767	763767	419	REC09440-05027	5033034	499-534	REC15710-65D00	5033708	395
REC0763767		421-422	REC09440-32008	5033037	499-534	REC15710-66D00	5032693	395
REC0763769	583410	419	REC09440-40002	5031286	505-534	REC15710-87J00	5031403	395
REC0763769	763769	419			509-510-511-513-517-519-531	REC15710-93J00	5035010	396
REC0763769		421	REC10-79953Q04	307551	513-517-519-531	REC15710-99E00	5030708	395
REC0763770	581651	419				REC160084	160084	517-525-528
REC0763770	584755	419	REC10W30U3		392	REC16433-93J00	5035022	487
REC0763770	585087	419	REC10W30U6		392	REC16510-05240	5033102, 7	391
REC0763770	763770	419	REC10W40U3		392	REC16510-82703	5033919	391
REC0763770		420	REC10W40U6		392	REC16510-82703	778887	391
REC0763773	584804	418			523-527-529-531	REC16510-87J00	5031411	391
REC0763773	763773	418	REC11-35921	314730	531	REC16510-87J00	778885	391
REC0763773		420-421	REC11141-87J02	5031293	463-464	REC16510-90J00	5033539	391
REC0763776	583289	418	REC11141-87J02	5034353	464	REC16510-90J00	778886	391
REC0763776	583379	418	REC11141-90J01	5033639	464	REC16510-93J00	5035703	391
REC0763776	582514	418	REC11141-91J10	5033342	464	REC16510-93J00	778888	391
REC0763776	583045	418	REC11141-92J01	5034644	464	REC16910-GB2-005	5030183	389
REC0763776	763776	418	REC11141-93E20	5033046	464	REC173944	173944	425
REC0763776		421-422	REC11141-93J10	5036629	464	REC173944	172588	425
REC0763779	584643	419	REC11141-93J10	5035971	464	REC17400-87E04	5031731	451-506
REC0763779	763779	419	REC11141-95J00	5036802	464	REC17400-90J20	5033541	451-507
REC0763779		422	REC11141-97J02	5037490	464	REC17400-92J00	5037176	450
REC0763782		421-422	REC11142-93J10	5035971	464	REC17400-93951	5033106	450-499
REC0763791	583512	413	REC11142-93J10	5036629	464	REC17400-93J01	5035036	451
REC0763791	584205	413	REC11189-87J00	5031297	463-465	REC17400-94J00	5037545	450
REC0763791	585192	413	REC11265-87E10	5030623	462-463	REC17400-95J02	5036908	451-501
REC0763791		414	REC11400-87804	5034354	465	REC17400-96403	5031744	451-503-505
REC0763793	582705	415	REC11400-87804	5036714	465	REC17400-96J03	5035036	508
REC0763803	584642	414-422	REC11400-87804	5031302	465	REC17400-98652	5030352	449
REC0763808	175386	417-420-421	REC11400-87804	5034354	465	REC17400-98661	5034323	449-497
REC0764708	581397	417-420	REC11400-87804	5036714	465	REC17411-93901	5033107	452-499
REC0765386	586015	414	REC11400-87804	5031302	465	REC17411-94421	5031990	445-503-505
REC0765386	586098	414	REC11413-87J00	5031304	463-466	REC17413-92J01	50367173	448
REC0765386	586292	414	REC11413-87J00	5032428	466	REC17413-95J00	5036900	448-501
REC0765386		421	REC11433-87J00	5031306	463-466	REC17413-96J01	5035038	508
REC0767407	433935	439-453	REC11489-87J00	5031307	463-484	REC17413-99E11		506
REC08110-60020	5033299	499-538	REC11489-90J00	5033649	484	REC17416-93J00	5035039	448
REC08110-60050	5033303	499-540	REC11489-93E11	5034462	484	REC17416-95J00	5036901	448-501
REC08113-60060	5032295	501-503-540	REC11489-93J00	5034878	484	REC17416-96J00	5035039	508
REC09116-06094	5030034	462-499-501-505-508	REC115742	115742	416-420	REC17417-92J00	5037175	448
REC09116-06121	5030391	462	REC12-191833	307552	509-510	REC17450-93921	5033109	499
REC09116-06121	5032502	462	REC12-191833	311598	519	REC17452-93910	5033110	449
REC09116-06121	5030391	501-503	REC12065		449-553	REC17453-93901	5033111	499-540
REC09141-12005	5032950	548	REC12104		452-454	REC17453-93901	5035609	540
REC09160-20027	5032966	533	REC12108		453	REC17461-87E12	5030723	506
REC09160-20041	5032985	499-533	REC125017	302540	445	REC17461-90J01	5033542	507-508
REC09160-20042	5032967	499-533	REC126776	126776	438	REC17461-93903	5033112	499
REC09160-20043	5032968	499-533	REC126870	126870	525-529	REC17461-96312	5031417	501-503-505
REC09160-20044	5032969	499-533	REC126870		538	REC17461-98503	5030188	497
REC09160-21009	5032970	499-533	REC126870	3852020	549	REC17462-93990	5033113	441-499
REC09160-26015	5031232	505-533	REC126870		550-552	REC17471-92J00	5034651	448
		489-497-499-501-503-505-506-507	REC127084	127084	519-520	REC17471-92J00	5037170	448
REC09168-10022	5030071	506-507	REC127084		538	REC17471-92J00	5030724	448
REC09168-10034	5034799	508-540	REC127084	127084	549	REC17471-92J00	5037170	448
REC09168-12012	5030465	391	REC127084		549-550-552	REC17471-92J00	5034651	506
REC09168-12017	5031863	391	REC12761-72F00	5030660	481	REC17471-92J00	5037170	507
REC09168-12017	5032987	391	REC12761-93E10	5033070	481	REC17471-92J02	5035041	448-508
REC09202-04002	5030084	505-548	REC12778-93J00	5034916	487	REC17471-93902	5033114	448-499
REC09202-05022	5031245	534	REC13119-93J00	5034959	486	REC17471-94401	5031418	448-503-505
REC09204-02004	5032996	548	REC13122-95J00	5036852	487	REC17471-95J01	5036902	448-501
REC09209-08016	5031880	501-503-534	REC13200-91J70	5036549	396	REC17471-97J00	5037431	448
		497-499-501-503-505-506-540	REC13200-91J70	5036191	396	REC17471-98601	5031196	448
REC09248-10008	5030094	507-540	REC13200-91J70	5036192	396	REC17471-98601	5030189	448
		499-537	REC13250-95D01	5033086	397	REC17472-87E10	5030725	446-506-507
REC09263-15019	5033002	501-503-537	REC13260		435	REC17472-91J00	5033381	449-497
REC09263-20046	5031883	501-503-540	REC13270		435-439	REC17472-93911	5035603	449-499
REC09263-20047	5031884	499-533	REC13280		435	REC17472-93J00	5035042	449-508
REC09263-20L04	5033003	505-540	REC13290		435	REC17472-96303	5036681	446
REC09263-22020	5031255	505-540	REC13310		435	REC17472-96303	5031419	446
REC09263-22L03	5031256	505-537	REC13350		434-439	REC17472-96303	5036681	463-501-503-505
REC09263-25025	5031257	505-541	REC13421-87J00	5031390	463-466	REC17472-97J00	5037432	448
REC09263-25062	5031258	505-541	REC13450		434	REC17472-98611	5030190	449
REC09265-17002	5031885	501-503-538	REC13650-52G00	5031392	399	REC175266	175266	550-551-552
REC09280-08005	5031260	539	REC13650-56B00	5030687	399	REC175267	175267	549-550-551-552
REC09280-11005	5031261	539	REC13910-89J01	5032424	397-398	REC175268	175268	549-551-552
REC09280-22019	5035305	462	REC1397-2150	983870	390	REC175269	175269	549-551-552
REC09280-54001	5033009	391	REC1397-2150	910139	390	REC17616-87J00	5031426	463
REC09280-57002	5033010	499-540	REC1399-07350	397839	392	REC17616-87J00	5031426	466
REC09280-75001	5031263	501-505-540	REC1399-07351	438562	392	REC17670-87J00	50317562	434
REC09282-10008	5030107	489-497	REC1399-07352	438555	392	REC17670-90J10	5033722	434
REC09282-12008	5030108	489	REC14151-93J00	5034978	482	REC17670-91J01	5033385	434
REC09282-12010	5033011	489	REC14152-93J00	5034979	482	REC17670-93962	5030742	434

REF	R.O. / OEM	
REC17670-93962	5031175	434
REC17670-93962	5030742	434
REC17670-94402	5031758	434
REC17670-94J01	5036226	434
REC17685-87D10	5031430	463-465
REC17693-95J00	5036914	487
REC17913-93J00	5035054	439
REC17914-93J00	5035055	439
REC18-32665	302804	548
REC18-4329		467
REC18-4330		467
REC18-4331		467
REC18-4332		467
REC18-6865	5005114	425
REC18-7044		398
REC18-7761		397-398
REC18-8355		467
REC18137-52D00	5035412	399
REC18590-72F21	5033780	399
REC203130	203130	475-479
REC21-20553	305981	531
REC22-67892A05	318544	509-515-519-520-525-528
REC22186		551-552
REC22660	397627 + 345992 + 332491	514-533
REC22660		535
REC22670	397338 + 318304 + 3180303	518-533
REC22670		535
REC23311-95DLO	5031449	539
REC24942		385
REC24950		385
REC24952		385
REC25-25439	3852565	445
REC25-30224	310327	515
REC25-30613	310585	445
REC25-30613	310967	445
REC25-30613	310585	452-531
REC25-33145	302337	445
REC25-35027	303360	445
REC25-48171	202893	445
REC25-62702	303191	445
REC25-62705	311338	445-513
REC25000	89876A3	385
REC25010		385
REC25020		385
REC25030		385
REC25222-93901	5030215	539
REC25222-96300	25222-96300	539
REC25700-87E00	5030973	442
REC25700-87E00	5034775	441
REC25700-88L00	5031456	441-505
REC25700-90J01	5033798	442-507
REC25700-92J00	5033922	442-507
REC25700-93J00	5035077	442-508
REC25700-95D01	5032167	441
REC25700-95D01	5036040	441
REC25700-95D01	5032167	503
REC25700-95J00	5037038	441-501
REC25700-99E00	5034776	441-506
REC25W40U3		392
REC26-01674	332583	513
REC26-43035		445
REC26-69188		444-445
REC26-69188	321453	443-513-531
REC26-76868		444-445
REC26-76868	320862	443-525-531
REC27-62386001	310058	433-435-436
REC27-62386001	332108	436
REC2TU3		392
REC2TU6		392
REC300-01633	330525	409
REC300-01744	203698	409
REC300-03585	586075	413-414
REC300-03586	586048	413-414
REC300-03587	585001	412-414
REC300-03588	584890	412-414
REC300-08010	439561	413-414
REC300-26084	583663	417
REC300-26084	583667	417
REC300-26084	584488	417
REC300-26084		420
REC300-26085	583896	417
REC300-26085	584329	417
REC300-26085	584331	417
REC300-26085	584489	417
REC300-26085		420-421
REC300611	300611	439-441-510
REC300771	300771	441
REC301877	301877	445-510-513
REC301967	301967	432-445-511
REC302035	302035	523-527-529
REC302325	302325	452-510
REC302325	324960	511
REC302325	302325	515-517-519-523-527-529
REC302325	302873	531
REC302497	302497	509-510-511-513
REC302537	302537	445
REC302564	302564	443-444
REC302588	302588	445-517

REF	R.O. / OEM	
REC303345	303345	443-444
REC303347	303347	445-513
REC303615	303615	393
REC304174	304174	445
REC304454	304454	510-513
REC305123	305123	445-525-531
REC305176	305176	483
REC305185	305185	390
REC305242	305242	445-509
REC305282	305282	515-517
REC305586	305586	437
REC305762	305762	517
REC306376	306376	515
REC306643	306643	433-452-510-523-527-529-531
REC307069	307069	476-479
REC307133	307133	485
REC307161	307161	520-528
REC308239	308239	390
REC308328	308328	437
REC308627	308627	510
REC308876	308876	445
REC308928	308928	439-441-517-519-531
REC309004	309004	511
REC309243	309243	515
REC309731	309731	445
REC309955	309955	531-548
REC309989	309989	443
REC31-02747	330854	470
REC31-02748	382481	470
REC31-02798	389613	470
REC31-02799	393896	469-470
REC31-02803	385503	470-471
REC31-02806	390641	470-471
REC31-17514A2	437088	469
REC31-32575T1	385175	517-536
REC310414	310414	445
REC310433	310433	470-471
REC310584	310584	445-515
REC310599	310599	443-444
REC310649	310649	443
REC311145	311145	437
REC311538	311538	523-527-529
REC313175	313175	445
REC313282	313282	443-444
REC313284	313284	443-444
REC313339	313339	515-517-519
REC313340	313340	445
REC313353	313353	443
REC313445	313445	519
REC313447	313447	519-536-537
REC313448	313448	519-520-525-529-531
REC313715	313715	519-525-528-531
REC313754	313754	445-519
REC313763	313763	480
REC313763	313715	520
REC313782	313782	475-479
REC314008	314008	452-519-523-527-529-531
REC314082	314082	517-519
REC314115	314115	488
REC314167	314167	443-444
REC314491	314491	445
REC314502	314502	515-517-519-520-548-549-550-552
REC314503	314503	515-517-519-520-548-549-550-552
REC314728	314728	445-523-527-529-531
REC314731	314731	520-525-531-536-537
REC314745	314745	523-527-529-531
REC315232	315232	398
REC315538	315538	484
REC315578	315578	486
REC315788	315788	517
REC315810	315810	515-517-519-520-549-550-552
REC315837	315837	517
REC315838	315838	517
REC315868	315868	482
REC315869	315869	482
REC316506	316506	510-513-515-531
REC316563	316563	531
REC317230	317230	519-536-537
REC317232	317232	519
REC317245	317245	432-433-435-437-439
REC317624	317624	515-523-527-529
REC317914	317914	529
REC317955	317955	483
REC318303	318303	483
REC318335	318335	519-533-535
REC318358	318358	484
REC318372	318372	475-480

REF	R.O. / OEM	
REC318373	318373	432-480
REC318395	318395	432-435-437-439
REC318717	318717	445
REC318917	318917	437
REC318924	318924	486
REC318925	318925	482
REC318932	318932	485
REC318971	318971	510-548-549-551-552
REC318972	318972	443-444-510
REC318995	318995	453-510
REC319085	319085	510
REC319174	319174	486
REC319276	319276	519
REC319332	319332	485
REC319348	319348	480
REC319586	319586	519
REC319633	319633	475-479
REC319665	319665	484
REC319710	319710	480
REC319890	319890	549-552
REC319891	319891	513-548-549-551-552
REC319895	319895	517-535
REC320041	320041	513-517-519
REC320140	320140	531
REC320145	320145	519-520
REC320166	320166	517
REC320167	320167	517
REC320168	320168	517
REC320305	320305	515-517-549
REC320305	320305	538-549-552
REC320310	320310	515-517
REC320311	320311	515-517
REC320570	320570	525-529-531-549
REC320570	320570	550-552
REC320635	320635	531-535
REC320679	320679	488
REC320775	320775 + 320776	447
REC320775	320775	453
REC320775	320775-6	517
REC320785	320785	513-548-551
REC320785	320785	549-552
REC320880	320880	433-435-438-439
REC320936	320936	483-523-527-529
REC320943	320943	452-523-527-529-531
REC320961	320961	483-523-527
REC320981	320981	453-517
REC321008	321008	452-523-527-529
REC321027	321027	433-435-437-439
REC321120	321120	433
REC321182	321182	483
REC321184	321184	433-435-437
REC321220	321220	435-437-439
REC321221	321221	433-435-438-439
REC321222	321222	433-435-438-439
REC321459	321459	443-444-511
REC321466	321466	443-444-445
REC321467	321467	443-444-468-515-517
REC321480	321480	443-444-510
REC321481	334950	443-444
REC321481	321481	510
REC321497	321497	489
REC321692	321692	432-435-436-439
REC321722	321722	488
REC321738	321738	510-513
REC321786	321786	443-444
REC321787	321787	443-444-511
REC321788	321788	443-444-468
REC321794	3214794	488
REC321831	321831	443-468
REC321886	321886	438
REC321895	321895	443-468
REC321921	321921	511
REC321928	321928	443-444-513
REC321932	321932	432-435-436
REC322494	322494	509
REC322938	322938	525-529
REC322941	322941	520-525
REC323214	323214	481
REC323338	323338	488
REC323361	323361	523-527-529
REC323362	323362	523-527-529
REC323469	323469	483
REC323582	323582	436
REC323664	323664	520
REC323664	323664	520-533
REC323664	323664	535
REC323889	323889	519
REC323890	323890	519
REC323942	323942	510-549-551-552
REC323943	323943	513-549-551-552
REC324097	324097	447-453-510

REF	R.O. / OEM		REF	R.O. / OEM		REF	R.O. / OEM	
REC38410-93J12	5036701	425	REC331353	331353	452-523-527-529-531	REC338893	338893	452-523-527-529-531
REC38410-93J12	5034606	425	REC331532	331532	487	REC339044	339044	436
REC324334	324334	510	REC331880	331880	519-525-528	REC339543	339543	445
REC324369	324369	519-520-525-529-531	REC331901	331901	439	REC339543	303059	445-517
REC324449	324449	511	REC331901	331901	441-517-519	REC339620	339620	443-468
REC324639	324639	443-444-509	REC331916	331916	482	REC340115	340115	475-480
REC324639	324639	509	REC331917	331917	482	REC340116	340116	476
REC324640	324640	453-509	REC331980	331980	509-517	REC340116	333554	476
REC324641	324641	447-453-509	REC331980	331980	324430	REC340116		480
REC324670	324670	523-527	REC331999	331999	520-525-528	REC340559	340559	467
REC324670	352165	529	REC332108	332108	437	REC340559	34559	467
REC324717	324717	480	REC332130	332130	436	REC340559	778417	467
REC324766	324766	519-520-536-537	REC332200-76G02	5031468	399	REC340619	340619	447
REC324852	324852	515-528	REC332200-76G02	5032786	399	REC340619		453-454
REC324937	324937	483-517-519	REC332261	332261	443-444-513	REC340619	340619	515-519
REC324981	324981	515-519	REC332266	332266	486	REC340811	340811	513
REC325040	325040	509	REC332319	332319	485	REC341038	341038	453-454 -515-519
REC325092	325092	485	REC332369	332369	432-435-437	REC341219	341219	520-528
REC325211	325211	482	REC332491	332491	515-533-535	REC341220	341220	523-527-529
REC325260	325260	486	REC332514	332514	515-536-537	REC341280	341280	443-523-527-529
REC325397	325397	447-453	REC332583	317178	445	REC341280	314281	529
REC325537	325537	513	REC332583	332584	445-452	REC341281	314281	443-525-529
REC325721	325721	480	REC332583	332583	445	REC341732	341732	515-517-519
REC326649	326649	445	REC332583	305739	445	REC342513	342513	432-481
REC326649	909047	445	REC332584	332584	515-517-528	REC342786	332205	443
REC326649	329380	445	REC332816	332816	476-479-480	REC342786	342786	443-515-519
REC326741	326741	445	REC332817	332817	476-480	REC342786		444
REC326849	326849	529	REC332818	332818	476-480	REC342786	321466	517
REC326926	326926	485	REC332819	332819	475-480	REC342786	332205	517
REC327031	327031	443-444	REC332944	332944	435-436	REC343105	343105	435-438
REC327345	327345	519-520	REC333008	333008	488	REC343105	3343105	438
REC327606		458	REC333572	333572	445-511	REC343141	343141	432-436
REC327606AL		458	REC333670	334726	476	REC343853	343853	481
REC327656	327656	523-527-529-531-536-537	REC333670	333670	476	REC343853	343863	482
REC327669	327669	525-529-536-537	REC333725	333725	515-536-537	REC344386	344386	481
REC327674	327674	484	REC333758	333758	515	REC344470	330619	441-511
REC327707	327707	485	REC333771	333771	515	REC344470	344470	513-517-519
REC32800-38F10	5036107	412	REC333771	342786	517	REC344771	344771	436
REC32800-87J10	5032615	412	REC333771		536-537	REC345257	345257	476-480
REC32800-89J00	5032030	412	REC333879	333879	481	REC345905	345905	527-537
REC32800-89J11	5034680	412	REC333957	333957	520-525-529	REC346006	346006	537
REC32800-90J00	5036618	412	REC33410-94400-000	5032732	400	REC34801-93J03	5035099	425
REC32800-90J00	5033820	412	REC334163	334163	517-519-520-525-529	REC34801-93J03	5036277	425
REC32800-92E20	5030795	412	REC334590	334590	510-549-552	REC34801-99E04	5036054	425
REC32800-93J03	5036637	413	REC334897	334897	439-441-515-519	REC34801-99E04	5031474	425
REC32800-94620	5034255	411	REC334950	334950	525-529	REC34801-99E04	5031116	425
REC32800-94J11	5036261	411	REC335334	335334	394	REC349193	349193	529-536-537
REC32800-95D01	5030356	411-420	REC335359	327795	475	REC35-49088A2	312456	390
REC328096	328096	517-519-525	REC335359	335359	475	REC35-53336	908034	390
REC328522	328522	510	REC335359	335359	479	REC35-802893Q		385
REC328522	552906	548	REC335361	335361	476	REC35-802893Q01		385
REC328522		549-552	REC335361	325647	476-480	REC350038	350038	529
REC328522	328522	551	REC335361	335361	480	REC350271	350271	520-525-529
REC328590	328590	481	REC335403	335403	480	REC350357	342291	484
REC328603	328603	467	REC335404	335404	485	REC351018	351018	480
REC328618	328618	480	REC335419	335419	485	REC351019	351019	483
REC328622	328622	486	REC335523	335523	445	REC352960	320499	470-471
REC328623	328623	475-480	REC335633	335633	486	REC353076	332942	443-468
REC328694	328694	515	REC335679	335679	537	REC354580	338601	523-529
REC328702	328702	523-527-529	REC335818	335818	485	REC356900	347371	529-537
REC328725	328725	509	REC335818	335818	485	REC377139	377139	470-471
REC328743	328743	520	REC335981	335981	436	REC37820-92E03	5031481	422
REC328744	328744	509	REC336178	336178	432-438	REC378252	378252	469-470-471
REC328751	328751	447-453-454-511-513	REC336185	336185	432	REC37830-89E03	5030225	422
REC328753	328753	513	REC336185	336185	438	REC37830-89E03	5032047	422
REC328754	328754	513	REC336226	336226	486	REC378444	378444	410
REC328755	328755	513-453-454	REC336227	336227	486	REC378444	777700	410
REC328825	328825	525	REC336289	336289	486	REC379504	379504	519-520
REC329076	329076	437	REC336308	336308	483	REC379504		536-537
REC329103	329103	475-479	REC336388	336388	486	REC38100-87J00	5031482	424
REC329390	329390	511	REC336493	336493	509	REC38100-96J00	5033838	424
REC329419	329419	475-479	REC336530	336530	515-519	REC38100-96J00	5034526	424
REC329718	329718	487	REC336947	336947	437	REC38100-96J00	5034627	424
REC329826	329826	483	REC336982	336982	515	REC38100-96J00	5035113	424
REC329828	329828	480	REC337061	337061	520-525-528	REC38100-96J00	5035513	424
REC329830	329830	432-437	REC337067	337067	437	REC38100-99E01-OEP	5030829	424
REC329836	329836	476-480	REC337068	337068	437	REC38100-99E01-OEP	5030828	424
REC329920	329920	484	REC337533	337533	438	REC38100-99E01-OEP	5030830	424
REC329922	329922	443-444-445	REC337774	337774	525-529-533	REC38100-99E01-OEP	5031166	424
REC329923	329923	443-444-445-468	REC337774	320630	531	REC382343	382343	515-519-536
REC329975	329975	481	REC337774	914716	533	REC382363	382363	397
REC330137	330137	443-444-445-468-519-520	REC337774	337778	535	REC382407	382407	515-519-520-525-529-536-537
REC330265	330265	515-520-525-528	REC337778	337778	520-525	REC382408	382408	519-520-525-531-536-537
REC330273	330273	438-439	REC338222	338222	475	REC384087	384087	446-453-517
REC330327	330327	443-444-468-511	REC338484	338484	452-523-527-529-531	REC384195	384195	523-536-537
REC330560	330560	445-453-511	REC338485	338485	536-537-452	REC385043	385043	519-520-536-537
REC330689	330689	489	REC338485	321188	454	REC385068	385068	519-536
REC330818	330818	475	REC338486	338486	447-452-527-529-531	REC385072	385072	439-454
REC330909	330909	489	REC338504	338504	523-527-529	REC385072	385072	519
REC331016	331016	483	REC338518	338518	445	REC3852045	329381	445
REC331103	331103	443	REC338518	338518	445-513	REC3852045	303067	445
REC331107	331107	439-441-452-523-529	REC338522	338522	445	REC3852056	332584	519
REC331188	331188	435-515-527-529	REC338632	338632	435-436	REC3852056	306394	509-525-529
REC331188	321175	529	REC338636	338636	523-529	REC3852056	3852056	548
REC331211	331211	476-480	REC338876	338876	393	REC3852120	313416	550-552
			REC338879	338879	393	REC3852548	3852548	443
			REC338882	338882	488	REC3852928	305270	445
						REC3852928	913921	515

REF	R.O. / OEM		REF	R.O. / OEM		REF	R.O. / OEM	
REC3853655	916058	443	REC398172	398172	478-480	REC439075		398
REC3855081	311598	513-515-517-520-525-528	REC398514	398514	393-395	REC439076	439076	397
REC3857533	584416	410	REC398529	398529	469-470-471	REC439076	434888	397
REC3857533	581295	410	REC398693	398693	479-480	REC439076	435443	397
REC3857533	582472	410	REC398874	398874	515	REC439076	398526	397
REC3857533	582473	410	REC398901	398901	515-536	REC439076	392550	397
REC3857533	586147	410	REC40135	398327	389	REC439076		398
REC3857533	586224	410	REC40135	398319	389	REC439077	439077	452-453
REC3857533	777702	410	REC40145	354016	389	REC439078	435752	396
REC386084	386084	439-453-510	REC40155		389	REC439078	439078	396
REC386280	386280	473	REC40165		389	REC439078	435678	396
REC386573	386573	488	REC40970		423	REC439078	43577	396
REC386573	319771	488	REC40990		423	REC439078	435676	396
REC386764	386764	515-517-536	REC414153	434153	551-552	REC439078		398
REC386765	386765	515-517-536	REC431870	431870	474	REC439083	393433	477
REC386766	386766	536	REC43211-87JLO	5032058	539	REC439083	439083	477
REC386866	386866	551-552	REC43211-94401	5032058	539	REC439083		479
REC386918	386279	473	REC432264	432264	515-536	REC439084	385416	477
REC387247	387247	525-531-536-537	REC432276	432276	515	REC439084	390078	477
REC387262	379312	398	REC432570	432570	478-480	REC439084		479-480
REC387262	387262	398	REC432941	432941	439-453-515	REC439085	389556	478
REC387262	387262	398	REC432955	432955	451-454	REC439085	391300	478
REC387656	387656	523-527-529-531	REC432962	432962	394-395	REC439085	439085	478
REC387656		536-537	REC433190	433190	389	REC439085		480
REC387787	387787	469-471	REC433190	765553	389	REC439138	439138	515-538
REC387817	387817	527-529-531	REC433550	433550	541-543	REC439185	439185	519-538
REC387817		536-537	REC433570	433570	517-535	REC439476	439476	523-527-529-531
REC388344	388344	469-470-471	REC434137	434137	433	REC439559	439559	478-480
REC38860-76F01	5033264	409	REC434381	434381	478	REC439973	439973	493-525
REC389039	389039	525-529	REC434381	394885	480	REC4428	5004428	393
REC389039		536-537	REC434391	434391	519	REC4428	5000800	393
REC389042	389042	525-529	REC434424	434424	439-453	REC4428	439347	393
REC389042		536-537	REC434467	434467	525-536-537	REC48630-92J00	5033935	426
REC389133	389133	451-453	REC434588	434588	515	REC48630-94900	5030870	426
REC389455	389455	525	REC434839	434839	391	REC5000074	5000074	525
REC389576	389576	439	REC434844	434844	468-471	REC5000308	5000308	450-453
REC389576		453	REC435027	435027	523	REC5000309	5000309	541-543
REC389576	436137	439-509	REC435123	435123	525-532	REC5000400	5000400	478-480
REC389577	389577	445-453-509	REC435123	336565	525	REC5000611	581670	418
REC390286	390286	439	REC435123		535	REC5000611	584504	418
REC390509	390509	473	REC435274	435274	515	REC5000611	584840	418
REC390510	390510	473	REC435390	435390	446-453-510	REC5000611	585073	418
REC390613	390613	445-453	REC435491	435491	433-435	REC5000611		420-421
REC390900	390900	469-470-471	REC435519	435519	519	REC5000614	5000614	529-538
REC391170	391170	473-474	REC435546	5006655	473	REC5000615	5000615	523-527-538
REC391416	391416	473-474	REC435548	435548	425	REC5000618	5000618	538
REC391741	391741	450-453	REC435548	983446	425	REC5000624	5000624	529-538
REC391988	391988	479-480	REC435548	985237	425	REC5000626	5000626	538
REC393088	393088	393	REC435597		435	REC5001036	5001036	433
REC393088		395	REC435957	435957	432	REC5001344	584767	416
REC393103	393103	394-395	REC435957	321692	438	REC5001344	584768	416
REC393561	393561	483	REC435990	435990	446	REC5001344	584908	416
REC393630	393630	450-453-513	REC435990	435990	454	REC5001344	585074	416
REC393632	393632	446-453-513	REC435990	435990	523-527	REC5001344		420-421
REC39390	398047	477	REC436254	436254	529	REC5001593	5001593	439
REC39390	438904	477	REC436353	436353	474	REC5001593	435821	439-452-523
REC39390		477	REC436358	436358	474	REC5001593		454
REC394408	394408	479-480	REC436745		458	REC5001593	5001593	527-529
REC394408		438-439	REC436745AL	436745	458-517-519-520-525-529	REC5001594	5001594	452-454
REC394411	394411	433	REC436888	436888	538	REC5001595	5001595	452-454
REC394462	394462	466	REC436888	436888	479	REC5004218	910994	525
REC394711	394711	449-453	REC436891	432571	479	REC5004218	5004218	532
REC394930	394930	473-474	REC436891	436891	479	REC5004218		535
REC395073	395073	452-454	REC436891	436891	480	REC5004257	5004257	525
REC395209	395209	525-538	REC436972	436972	474	REC5004428	5004428	393
REC395270	395270	450	REC437090	437090	433-435	REC5004428	5000800	393
REC395270		453	REC43711-97E11	5030852	539	REC5004428	439347	393
REC395289	395289	439	REC43713		542	REC5004532	584808	415
REC395289		453-454	REC437155	437155	479-480	REC5004532	585145	415
REC395289	395289	511-513	REC437288	437288	513	REC5004532	585189	415
REC395401	395401	469-470	REC437330	437330	523-527-529	REC5004532	5004533	415
REC395627	395627	468-470-471	REC437725	437725	479-480	REC5004532		415
REC395861	395861	466	REC437907	437907	450-454	REC5004705	394488	466
REC396350	396350	541-543	REC438543	438543	446-453-454	REC5004765	5004765	525-529-538
REC396351	396351	513-541-543	REC438544	3438544	519	REC5005034	5005034	551-552
REC396352	396352	542-453	REC438544		445	REC5005801	5005801	409
REC396355	396355	541-543	REC438544		453	REC5005801	175974	409
REC396377	396377	473-474	REC438544	438544	515	REC5005907	5005907	477-479
REC396379	396379	473-474	REC438545	438545	453-515	REC5005931	5005931	478-480
REC396504	396504	473-474	REC438559	438559	393	REC5006180	5006180	428
REC396520	396520	398	REC438559	765591	393	REC5006181	5006181	428
REC396521	378895	398	REC438579	438579	451-454	REC5006182	5006182	429
REC396521	396521	398	REC438592	438592	451-453	REC5006184	5006184	429
REC396521	678882	398	REC438602	438602	450-453	REC5006186	5006186	429
REC396521		398	REC438616	438616	394-395	REC5006241	5006241	523-527-529
REC396522	379312	398	REC438996	438996	396	REC5006373	5006373	541-543
REC396522	396522	398	REC438996	438996	396	REC5006657	5006657	473
REC396522		398	REC438996	438996	396	REC5006658	5006658	473
REC396644		453	REC439071	439071	396	REC5006662	5006662	473
REC396701	396701	397	REC439071	398532	396	REC5006664	5006664	473
REC396701	398729	397	REC439071	383067	396	REC5006665	5006665	473
REC396701	392061	397	REC439071	383052	396	REC5006666	5006666	474
REC396701		398	REC439071	382049	396	REC5006668	5006668	473
REC396725	396725	439-519	REC439071		398	REC5006669	5006669	473
REC396725		453-454	REC439072	439072	396	REC5006670	5006670	473
REC396750	396750	478-480	REC439072	398452	396	REC5006687	5006687	474
REC396987	396987	433-435-439	REC439072	391305	396	REC5006688	5006688	474
REC397537	397537	515	REC439072	398453	396	REC5006694	5006694	474
REC397538	397538	515-536	REC439072		398	REC5006701	5006701	474
REC398042	398042	525-529-551	REC439074	4359073	397-398	REC5006702	5006702	474
REC398042		550-552	REC439075	439074	397	REC5006711	5006711	474
REC398051	398051	467	REC439075	439075	397	REC5006713	5006713	474

REF	R.O. / OEM		REF	R.O. / OEM		REF	R.O. / OEM	
REC5006714	5006714	474	REC584580	584580	409	REC925093	5031890	503
REC5006716	5006716	474	REC586774	586774	410	REC925093	320303	517
REC5006751	5006751	474	REC586774	5009214	410	REC93-06511	312932	408
REC5007022	439972	493	REC59178-97J00	5037356	540	REC93-06511		408
REC5007022	438048	493	REC5W40U3		392	REC93-06522	323653	408
REC5007022		493	REC5W40U6		392	REC93-06522	338534	408
REC5007022	439972	525	REC63P-13907-03	5032617	393	REC93-06522		408
REC5007129	5007129	479-480	REC63P-13907-03	5033702	393	REC93-08663	203697	408
REC5007190	387041	469-471	REC63P-13907-03	5036635	393	REC93-08664	203725	408
REC5007335	5007326	389	REC63P-13907-03	5030700	393	REC93-08665	330527	408
REC5007335	5005266	389	REC65720-98520	5033221	384	REC93-08666	331970	408
REC5007672	5000623	529-538	REC65720-986L0	5032150	384	REC93-08667	335905	408
REC5007850	5007850	477-480	REC65L-24563-00	5035695	389	REC93-08668	395460	408
REC5007968	435959	446-454	REC65L-24563-00	778162	389	REC93606-12019	5030508	507-508
REC5007968	435959	523-527-531	REC67F-12411-01	5033722	434	REC967344	313446	445-519-520
REC5008966	320569	531-550	REC69J-24501-10	5034995	391	REC981195	981195	443
REC5010190		458	REC6F5-12411-03	5005440	432-433	REC981196	981196	443
REC5010190AL		458	REC6F5-12411-03	434841	433-435	REC981268	981268	443
REC51123-93J00	5035133	487	REC6F5-12411-03		439	REC981911	981911	390
REC51142-93J00	5035135	465	REC70720		388	REC982230	982230	390
REC51211-87J00	5031523	463-465	REC763735	387361	439-453	REC984491	984491	390
REC51211-90J10	5034757	465	REC763775	583533	418	REC986979	22631 + 22632 + 22633	532
REC51211-90J2	5037205	465	REC763775	584586	418	REC986979		535
REC51211-93J00	5035138	465	REC763775	763775	418	REC986979		385
REC51212-94400	5031535	449	REC763775		422	REC986979		386
REC51212-90J01AL	5032929	506-507	REC764102	387139	469	REC986979		386
REC51212-90J01AL	5035150	508	REC764102	387142	469	REC986979		386
REC51212-91J01AL	5032191	503	REC764102		470-471	REC986979		386
REC51212-91L01		458	REC764337	313992	443	REC986979		426
REC51212-91L01AL		458	REC765431	382547	439-454-519	REC986979		426
REC51212-91L01AL	5032091	501	REC765642	329391	453-511	REC986979		426
REC51212-95500		458	REC766779	335360	476	REC986979		426
REC51212-95500AL		458	REC766779	320745	476	REC986979		426
REC51212-93J10	5035151	508-540	REC766779		480	REC986979		426
REC51212-93J10		458	REC766871	318609	484	REC986979		426
REC51212-93J10		458	REC767970	305987	443-468	REC986979		386
REC51212-93J10		458	REC775518	375638	439-453	REC986979		385
REC51212-93J10		458	REC777129	389589	439	REC986979		494
REC51212-93J10		458	REC777129		453	REC986979		392
REC51212-93J10		458	REC777129	331107	527	REC986979		392
REC51212-93J10		458	REC777212	389642	439	REC986979		392
REC51212-93J10		458	REC777212		454	REC986979		392
REC51212-93J10		458	REC777212	385528	531	REC986979		392
REC51212-93J10		458	REC777213	377230	439-453-517	REC986979		545
REC51212-93J10		458	REC777214	396809	439-453-517	REC986979		545
REC51212-93J10		458	REC802113	394546	477-479	REC986979		545
REC51212-93J10		458	REC802133	433941	477	REC986979		545
REC51212-93J10		458	REC802133	392567	477	REC986979		545
REC51212-93J10		458	REC802133	392615	477	REC986979		545
REC51212-93J10		458	REC802133		479	REC986979		545
REC51212-93J10		458	REC802243	313065	482	REC986979		545
REC51212-93J10		458	REC802288	325273	475-479	REC986979		545
REC51212-93J10		458	REC802307	332010	475-479	REC986979		545
REC51212-93J10		458	REC80W90U3		392	REC986979		545
REC51212-93J10		458	REC80W90U6		392	REC986979		545
REC51212-93J10		458	REC855686		385	REC986979		545
REC51212-93J10		458	REC87604		542-543	REC986979		545
REC51212-93J10		458	REC87606		542	REC986979		545
REC51212-93J10		458	REC87607		542	REC986979		545
REC51212-93J10		458	REC87608		542-543	REC986979		545
REC51212-93J10		458	REC87617		542-543	REC986979		545
REC51212-93J10		458	REC87619		542-543	REC986979		545
REC51212-93J10		458	REC87622		542-543	REC986979		545
REC51212-93J10		458	REC87670		468	REC986979		545
REC51212-93J10		458	REC878763	396041	469-471	REC986979		545
REC51212-93J10		458	REC878846	313413	476-479-480	REC986979		545
REC51212-93J10		458	REC878904	436195	432-433-439	REC986979		545
REC51212-93J10		458	REC89-825096T01	5030783	409	REC986979		545
REC51212-93J10		458	REC90095		494	REC986979		545
REC51212-93J10		458	REC90171-18M04	5030422	505-506-507-508	REC986979		545
REC51212-93J10		458	REC90171-18M04	09141-18005	548	REC986979		545
REC51212-93J10		458	REC90179-08M06	5031827	501-503	REC986979		545
REC51212-93J10		458	REC90794-46866		386	REC986979		545
REC51212-93J10		458	REC908158	908158	519-520-525-529	REC986979		545
REC51212-93J10		458	REC908194	908194	445	REC986979		545
REC51212-93J10		458	REC908383	908383	445	REC986979		545
REC51212-93J10		458	REC908855	908855	443	REC986979		545
REC51212-93J10		458	REC90890-06820	90890-06820	495	REC986979		545
REC51212-93J10		458	REC90890-06820	91-83164M	495	REC986979		546
REC51212-93J10		458	REC909140	909140	445	REC986979		546
REC51212-93J10		458	REC909386	909386	517-519	REC986979		546
REC51212-93J10		458	REC91-00001		494	REC986979		546
REC51212-93J10		458	REC91-00002		494	REC986979		546
REC51212-93J10		458	REC91-31229	91-31229	494	REC986979		546
REC51212-93J10		458	REC91-34569A1	91-34569A1	494	REC986979		546
REC51212-93J10		458	REC91-36569T	91-36569T	494	REC986979		546
REC51212-93J10		458	REC91-37241		494	REC986979		546
REC51212-93J10		458	REC91-61067A04	91-61067A04	495	REC986979		546
REC51212-93J10		458	REC91-61069T	91-61069T	495	REC986979		546
REC51212-93J10		458	REC91-859046Q3	91-859046Q3	495	REC986979		546
REC51212-93J10		458	REC91-859046Q4	91-821887T1	495	REC986979		546
REC51212-93J10		458	REC91-895343T02	91-895343T02	495	REC986979		546
REC51212-93J10		458	REC91-895343T02	91-895343T01	495	REC986979		546
REC51212-93J10		458	REC911019	911019	443	REC986979		546
REC51212-93J10		458	REC9111685	9111685	443	REC986979		546
REC51212-93J10		458	REC9111961	9111961	519-520	REC986979		546
REC51212-93J10		458	REC911962	911962	525-528	REC986979		546
REC51212-93J10		458	REC91490-30025	5030087	497-503-508-548	REC986979		546
REC51212-93J10		458	REC91490-40030	5030087	501-505-506-507	REC986979		546
REC51212-93J10		458	REC915954	915954	520-525	REC986979		546

REF	R.O. / OEM		REF	R.O. / OEM	
SOL2531-143-17	391290	546	SOLRBX-100		547
SOL2531-145-15	391535	546	SOLRBX-101		547
SOL2531-145-15	174926	546	SOLRBX-106		547
SOL2532-140-19		546	SOLRBX-110		547
SOL2532-140-19	390821	546	SOLRBX-111		547
SOL2532-140-21		546	SOLRBX-125		547
SOL2532-140-21	390822	546	SOLRBX-126		547
SOL2532-140-23		546	STA93900		431
SOL2532-140-23	390823	546	STA93922		431
SOL2532-143-17		546	STA93932		431
SOL2532-143-17	431930	546	STA94100		431
SOL2532-145-15		546			
SOL2532-145-15	174927	546			
SOL3413-138-15	5033322	546	TEN00900	976669	459
SOL3413-138-17	5033323	546	TEN00901	982277	459
SOL3413-138-19	5033324	546	TEN00902	385818	459
SOL3413-138-21	5033325	546	TEN00902	982438	459
SOL3451-139-17	5033323	546	TEN00903	3853818	459
SOL3451-139-17	5033327	546	TEN00903	984513	459
SOL3451-139-19	5033324	546	TEN00904	983952	459
SOL3451-139-19	5033328	546	TEN00905	338742	461
SOL3451-139-21	5033325	546	TEN00906	983494	459
SOL3451-139-21	5033329	546	TEN00907	393023	460
SOL3451-139-23	5033326	546	TEN00907	436745	460
SOL3451-139-23	5033330	546	TEN00907AL	393023	460
SOL3452-139-17	5033955	546	TEN00907AL	436745	460
SOL3452-139-19	5033956	546	TEN00907BIS	397768	460
SOL3452-139-21	5033957	546	TEN00908	392123	460
SOL4011-079-07S	5034345	497	TEN00909	392462	461
SOL4111-093-07A	5033200	545	TEN00910	398331	461
SOL4111-093-08A	5005383	545	TEN00910	433458	461
SOL4111-093-09A	5005384	545	TEN00911	395780	460
SOL4111-093-10A	5005385	545	TEN00911AL	395780	460
SOL4111-093-11A	5033203	545	TEN00912	173029	462
SOL4211-100-14	5032110	545	TEN00912	123009	462
SOL4211-101-13	5032109	545	TEN00912	327606	462
SOL4211-103-12	5032108	545	TEN00913	432397	460
SOL4211-105-11	5032107	545	TEN00913	334451	460
SOL4311-116-12	5031624	545	TEN00914	434029	461
SOL4311-116-13	5031619	545	TEN00914/1	434029	461
SOL4311-116-14	5031620	545	TEN00915	398873	461
SOL4311-118-11	5031623	545	TEN00916	984547	459
SOL4311-120-10	5031622	545	TEN00917	431708	460
SOL4511-150-15		546	TEN00918	5007089	460
SOL4511-153-19		546	TEN00918	433580	460
SOL4511-153-21		546	TEN00918AL	5007089	460
SOL4511-155-17		546	TEN00918AL	433580	460
SOL4512-153-19		546	TEN00919	986158	459
SOL4512-153-21		546	TEN00919	3853930	459
SOL4512-155-17		546	TEN00920	987067	459
SOL4512-158-15		546	TEN00920	3854061	459
SOL4571-148-23		546	TEN00920	987067	459
SOL4571-149-22		546	TEN00921	338635	460
SOL4571-151-20		546	TEN00922	3854130	459
SOL4571-154-18		546	TEN00923		460
SOL4572-148-23		546	TEN00925	5031705	460
SOL4572-149-22		546	TEN00925AL	5031705	460
SOL4572-151-20		546	TEN00926	5034616	461
SOL4572-154-18		546	TEN00926	5030907	461
SOL9311-111-13		547	TEN00926AL	5034616	461
SOL9311-114-12		547	TEN00926AL	5030907	461
SOL9411-132-19		547	TEN00927	5032929	462
SOL9411-132-21		547	TEN00928	397768	460
SOL9411-133-17		547	TEN00928AL	397768	460
SOL9411-135-15		547	TEN00929	389999	459
SOL9411-138-13		547	TEN00930	5030265	459
SOL9411-140-09		547	TEN00930	5035786	459
SOL9411-140-11		547	TEN00931	5031536	461
SOL9431-130-19		547	TEN00932	5030267	461
SOL9431-130-21		547	TEN00933	5031705	461
SOL9431-133-17		547	TEN00934	5033185	461
SOL9431-135-15		547	TEN00935	5031538	461
SOL9431-138-13		547	TEN00936	5033167	461
SOL9432-130-19		547	TEN00937	5032930	461
SOL9432-133-17		547	TEN00937AL	5032930	461
SOL9432-135-15		547	TEN01205		462
SOL9432-138-13		547	TEN01213		462
SOL9511-143-21		547	TENKITOMC-50-75		462
SOL9511-145-19		547	TENKITOMC-V4-V6		462
SOL9511-148-17		547			
SOL9511-150-15		547			
SOL9511-153-13		547			
SOL9511-155-11		547			
SOL9511-160-13		547			
SOL9531-140-19		547			
SOL9531-140-21		547			
SOL9531-140-23		547			
SOL9531-143-17		547			
SOL9531-145-15		547			
SOL9532-140-19		547			
SOL9532-140-21		547			
SOL9532-140-23		547			
SOL9532-143-17		547			
SOL9532-145-15		547			
SOL9571-148-23		547			
SOL9571-150-21		547			
SOL9571-153-19		547			
SOL9571-155-17		547			
SOL9571-158-15		547			
SOL9572-148-23		547			
SOL9572-150-21		547			
SOL9572-153-19		547			
SOL9572-155-17		547			
SOL9572-158-15		547			

RO / OEM --> REF

RO/OEM	REF	RO/OEM	REF	RO/OEM	REF
0323327	REC0323327	398	302804	REC18-32665	548
34559	REC340559	467	302873	REC302325	531
43577	REC439078	396	303059	REC339543	445-517
98410	PH375-0029	409	303067	REC3852045	445
115742	REC115742	416	303191	REC25-62702	445
123009	CM123009	455	303345	REC303345	443
123009	TEN00912	462	303347	REC303347	445-513
126776	REC126776	438	303360	REC25-35027	445
126870	REC126870	525-529	303615	REC303615	393
127084	REC127084	519-520	304174	REC304174	445
127084	REC127084	549	304454	REC304454	510-513
160084	REC160084	517-525-528	304784	REC304784	445
172588	REC173944	425	305123	REC305123	445-525-531
172869	PH375-0033	410	305176	REC305176	483
172869	REC581528	410	305185	REC305185	390
173029	CM123009	510	305242	REC305242	445-509
173029	CM123009A	455	305270	REC3852928	445
173029	TEN00912	462	305282	REC305282	515-517
173105	PREMC30508	430	305586	REC305586	437
173106	PREMC30506	430	305739	REC332583	445
173107	PREMC30507	430	305762	REC305762	517
173109	PREMC30509	430	305981	REC21-20553	531
173110	PREMC30510	430	305987	REC767970	443
173111	PREMC30511	430	306376	REC306376	515
173112	PREMC30512	430	306394	REC3852056	509-525-529
173113	PREMC30513	430	306643	REC306643	433-452-510-523-527-529-531
173114	PREMC30514	430	307069	REC307069	476
173115	PREMC30515	430	307133	REC307133	485
173116	PREMC30516	430	307161	REC307161	520-528
173117	PREMC30517	430	307551	REC10-79953Q04	509-510-511-513-517-519-531
173118	PREMC30518	430	307552	REC12-191833	509-510
173119	PREMC30519	430	308239	REC308239	390
173120	PREMC30520	430	308328	REC308328	437
173121	PREMC30521	430	308627	REC308627	510
173122	PREMC30522	430	308876	REC308876	445
173124	PREMC30524	430	308928	REC308928	441-517-519-531
173944	REC173944	425	309004	REC309004	511
174508	GS31084	384	309243	REC309243	515
174817	SOL2111-093-11	545	309731	REC309731	445
174926	SOL2531-145-15	546	309955	REC309955	531-548
174927	SOL2532-145-15	546	309989	REC309989	443
174938	SOL2111-093-08	545	310058	REC27-62386001	433-435-436
174950	SOL2111-093-10	545	310327	REC25-30224	515
175190	SOL2211-105-11	545	310414	REC310414	445
175191	SOL2211-101-13	545	310433	REC310433	470
175266	REC175266	551	310584	REC310584	445-515
175267	REC175267	551	310585	REC25-30613	445-452-531
175268	REC175268	551	310599	REC310599	443
175269	REC175269	551	310649	REC310649	443
175316	REC0175316	415	310967	REC25-30613	445
175386	REC0763808	417	311145	REC311145	437
175974	REC5005801	409	311338	REC25-62705	445-513
176214	SOL2411-133-17	545	311538	REC311538	523-527-529
176214	SOL2413-128-17	545	311598	REC12-191833	519
176214	SOL2431-133-17	545	311598	REC3855081	513-515-517-520-525-528
176215	SOL2411-130-19	545	312456	REC35-49088A2	390
176215	SOL2413-125-19	545	312932	REC93-06511	408
176215	SOL2431-130-19	545	313065	REC802243	482
176216	SOL2411-130-21	545	313175	REC313175	445
176216	SOL2413-125-21	545	313282	REC313282	443
176216	SOL2431-130-21	545	313284	REC313284	443
176333	REC0176333	430	313339	REC313339	515-517-519
176335	REC0176335	430	313340	REC313340	445
176340	REC0176340	430	313353	REC313353	443
176342	REC0176342	430	313413	REC878846	476
176408	REC0176408	429	313416	REC3852120	436
176421	SOL2311-123-15	545	313445	REC313445	519
176422	SOL2311-120-17	545	313446	REC967344	445-519-520
176424	SOL2211-103-12	545	313447	REC313447	519
176425	SOL2211-100-14	545	313448	REC313448	519-520-525-529-531
202893	REC25-48171	445	313715	REC313715	519-525-528-531
203130	REC203130	475	313715	REC313763	520
203697	REC93-08663	408	313754	REC313754	445-519
203698	REC300-01744	409	313763	REC313763	480
203725	REC93-08664	408	313782	REC313782	475
277432	PH130-0038	405	313893	REC338518	445
278232	PH130-0038	405	313992	REC764337	443
289019	SOL2531-140-23	546	314008	REC314008	452-519-523-527-529-531
300611	REC300611	441-510	314082	REC314082	517-519
300771	REC300771	441	314115	REC314115	488
301877	REC301877	445-510-513	314167	REC314167	443
301967	REC301967	432-445-511	314281	REC314281	443-525-529
302035	REC302035	523-527-529	314491	REC314491	445
302325	REC302325	452-510	314502	REC314502	515-517-519-520-548
302325	REC302325	515-517-519-523-527-529	314503	REC314503	515-517-519-520-548
302337	REC25-33145	445	314728	REC314728	445-523-527-529-531
302497	REC302497	509-510-511-513	314730	REC11-35921	523-527-529-531
302537	REC302537	445	314731	REC314731	520-525-531
302540	REC125017	445			
302564	REC302564	443			
302588	REC302588	445-517			
314745	REC314745	523-527-529-531			
315232	REC315232	398			
315538	REC315538	484			
315578	REC315578	486			
315788	REC315788	517			
315810	REC315810	515-517-519-520-549			
315837	REC315837	517			
315838	REC315838	517			
315868	REC315868	482			
315869	REC315869	482			
316506	REC316506	510-513-515-531			
316563	REC316563	531			
317178	REC332583	445			
317230	REC317230	519			
317232	REC317232	519			
317245	REC317245	432-433-435-437			
317624	REC317624	515-523-527-529			
317914	REC317914	483			
317955	REC317955	483			
318303	REC318303	519-533			
318335	REC318335	484			
318358	REC318358	475			
318372	REC318372	445-515-517-519-523-527-529-531			
318373	REC318373	432-480			
318395	REC318395	432-435-437			
318544	REC22-67892A05	509-515-519-520-525-528			
318609	REC766871	484			
318717	REC318717	445			
318917	REC318917	437			
318924	REC318924	486			
318925	REC318925	482			
318932	REC318932	485			
318971	REC318971	510-548			
318972	REC318972	443-510			
318995	REC318995	510			
319085	REC319085	510			
319174	REC319174	486			
319276	REC319276	519			
319332	REC319332	485			
319348	REC319348	480			
319586	REC319586	519			
319633	REC319633	475			
319661	REC0319661	485			
319662	REC0319662	445			
319665	REC319665	484			
319710	REC319710	480			
319890	REC319890	549			
319891	REC319891	513-548-551			
319895	REC319895	517			
320041	REC320041	513-517-519			
320140	REC320140	531			
320145	REC320145	519-520			
320166	REC320166	517			
320167	REC320167	517			
320168	REC320168	517			
320303	REC925093	517			
320305	REC320305	515-517-549			
320310	REC320310	515-517			
320311	REC320311	515-517			
320499	REC352960	470			
320569	REC5008966	531			
320570	REC320570	525-529-531-549			
320630	REC337774	531			
320635	REC320635	531			
320679	REC320679	488			
320745	REC766779	476			
320785	REC320785	513-548-551			
320862	REC26-76868	443-525-531			
320880	REC320880	433-435-438			
320936	REC320936	483-523-527-529			
320943	REC320943	452-523-527-529-531			
320961	REC320961	483-523-527			
320981	REC320981	517			
321008	REC321008	452-523-527-529			
321027	REC321027	433-435-437			
321120	REC321120	433			
321175	REC331188	531			
321182	REC321182	483			
321184	REC321184	433-435-437			
321188	REC338485	531			
321220	REC321220	435-437			
321221	REC321221	433-435-438			
321222	REC321222	433-435-438			
321453	REC26-69188	443			
321453	REC26-69188	513-531			
321459	REC321459	443-511			
321466	REC321466	443			
321466	REC324786	517			
321467	REC321467	443-515-517			
321479	REC0321479	486			

RO/OEM	REF		RO/OEM	REF		RO/OEM	REF	
321480	REC321480	443-444-510	329380	REC326649	445	335523	REC335523	445
321481	REC321481	510	329381	REC3852045	445	335633	REC335633	486
321497	REC321497	489	329390	REC329390	511	335679	REC335679	537
321692	REC321692	432-435-436	329391	REC765642	511	335818	REC335818	485
321692	REC435957	438	329419	REC329419	475	335819	REC335819	485
321738	REC321738	510-513	329718	REC329718	487	335905	REC93-08667	408
321786	REC321786	443	329826	REC329826	483	335981	REC335981	436
321787	REC321787	443-511	329828	REC329828	480	336178	REC336178	432-438
321788	REC321788	443	329830	REC329830	432-437	336185	REC336185	432-438
321831	REC321831	443	329836	REC329836	476	336226	REC336226	486
321886	REC321886	438	329920	REC329920	484	336227	REC336227	486
321895	REC321895	443	329922	REC329922	443	336308	REC336308	483
321921	REC321921	511	329923	REC329923	443	336388	REC336388	486
321928	REC321928	443-513	329975	REC329975	481	336389	REC336289	486
321932	REC321932	432-435-436	330137	REC330137	443-519-520	336493	REC336493	509
322494	REC322494	509	330265	REC330265	515-520-525-528	336530	REC336530	515-519
322938	REC322938	525-529	330273	REC330273	438	336565	REC435123	525
322941	REC322941	520-525	330327	REC330327	443-511	336947	REC336947	437
323214	REC323214	481	330525	REC300-01633	409	336982	REC336982	515
323338	REC323338	488	330527	REC93-08665	408	337061	REC337061	520-525-528
323361	REC323361	523-527-529	330560	REC330560	445-511	337067	REC337067	437
323362	REC323362	523-527-529	330619	REC344470	441-511	337068	REC337068	437
323469	REC323469	483	330621	REC0330621	480	337533	REC337533	438
323582	REC323582	436	330698	REC330698	489	337774	REC337774	525-529-533
323653	REC93-06522	408	330818	REC330818	475	337778	REC337778	520-525
323664	REC323664	520-533	330854	REC31-02747	470	338222	REC338222	475
323889	REC323889	519	330909	REC330909	489	338484	REC338484	452-523-527-529-531
323890	REC323890	519	331016	REC331016	483	338485	REC338485	452-527-529
323942	REC323942	510-549-551	331103	REC331103	443	338486	REC338486	447-452-527-529-531
323943	REC323943	513-549-551	331107	REC331107	441-452-523-529	338504	REC338504	523-527-529
324097	REC324097	447-510	331107	REC777129	527	338518	REC338518	445-513
324334	REC324334	510	331188	REC331188	435-515-527-529	338522	REC338522	445
324369	REC324369	519-520-525-529-531	331211	REC331211	476	338534	REC93-06522	408
324430	REC331980	517	331353	REC331353	452-523-527-529-531	338601	REC354580	523-529
324449	REC324449	511	331532	REC331532	487	338632	REC338632	435-436
324639	REC324639	443-509	331880	REC323664	520	338635	CM338635	455
324640	REC324640	509	331880	REC331880	519-525-528	338635	TEN00921	460
324641	REC324641	447-509	331901	REC331901	441-517-519	338636	REC338636	523-529
324670	REC324670	523-527	331916	REC331916	482	338742	CM338742	457
324717	REC324717	480	331917	REC331917	482	338742	TEN00905	461
324766	REC324766	519-520	331970	REC93-08666	408	338876	REC338876	393
324852	REC324852	515-528	331980	REC331980	509-517	338879	REC338879	393
324937	REC324937	483-517-519	331999	REC331999	520-525-528	338882	REC338882	488
324960	REC302325	511	332010	REC802307	475	338893	REC338893	452-523-527-529-531
324981	REC324981	515-519	332108	REC27-62386001	436	339044	REC339044	436
325040	REC325040	509	332108	REC332108	437	339620	REC339620	443
325092	REC325092	485	332130	REC332130	436	340115	REC340115	475
325211	REC325211	482	332205	REC342786	443-517	340116	REC340116	476
325260	REC325260	486	332261	REC332261	443-513	340559	REC340559	467
325273	REC802288	475	332266	REC332266	486	340619	REC340619	447-515-519
325397	REC325397	447	332319	REC332319	485	340811	REC340811	513
325537	REC325537	513	332369	REC332369	432-435-437	340975	REC0340975	455
325647	REC335361	476	332491	REC332491	515-533	340976	REC0340976	455
325721	REC325721	480	332514	REC332514	515	341038	REC341038	515-519
326260	REC0326260	486	332583	REC26-01674	513	341219	REC341219	520-528
326264	REC0326264	482	332583	REC332583	445	341220	REC341220	523-527-529
326649	REC326649	445	332584	REC332584	445-452	341280	REC341280	443-523-527-529
326741	REC326741	445	332584	REC332584	515-517-528	341732	REC341732	515-517-519
326849	REC326849	529	332584	REC3852045	519	342291	REC3350357	484
326877	REC0326877	408	332816	REC332816	476	342513	REC342513	432-481
326926	REC326926	485	332817	REC332817	476	342786	REC333771	517
327031	REC327031	443	332818	REC332818	476	342786	REC342786	443-515-519
327345	REC327345	519-520	332819	REC332819	475	343105	REC343105	435-438
327606	CM327606	455	332942	REC353076	443	343141	REC343141	432-436
327606	CM327606A	455	332944	REC332944	435-436	343853	REC343853	481
327606	TEN00912	462	333008	REC333008	488	343863	REC343863	482
327656	REC327656	523-527-529-531	333554	REC340116	476	344386	REC344386	481
327669	REC327669	525-529	333572	REC333572	445-511	344470	REC344470	513-517-519
327674	REC327674	484	333670	REC333670	476	344771	REC344771	436
327707	REC327707	485	333725	REC333725	515	345257	REC345257	476
327795	REC335359	475	333758	REC333758	515	345905	REC345905	527-537
328096	REC328096	517-519-525	333771	REC333771	515	346006	REC346006	537
328522	REC328522	510-551	333879	REC333879	481	347371	REC356900	529-537
328590	REC328590	481	333957	REC333957	520-525-529	349193	REC349193	529
328603	REC328603	467	334163	REC334163	517-519-520-525-529	350038	REC350038	529
328618	REC328618	480	334451	CM334451	455	350271	REC350271	520-525-529
328622	REC328622	486	334451	CM334451A	455	351018	REC351018	480
328623	REC328623	475	334451	TEN00913	460	351019	REC351019	483
328694	REC328694	515	334590	REC334590	510-549	352165	REC324670	529
328702	REC328702	523-527-529	334665	REC0334665	466	354016	REC40145	389
328725	REC328725	509	334726	REC333670	476	375638	REC775518	439
328743	REC328743	520	334897	REC334897	441-515-519	377139	REC377139	470
328744	REC328744	509	334950	REC321481	443	377230	REC777213	439
328751	REC328751	447-511-513	334950	REC334950	525-529	377230	REC777213	517
328753	REC328753	513	335334	REC335334	394	378252	REC378252	469
328754	REC328754	513	335359	REC335359	475	378444	REC378444	410
328755	REC328755	513	335360	REC766779	476	378674	PH130-0038	405
328825	REC328825	525	335361	REC335361	476	378895	REC396521	398
329076	REC329076	437	335403	REC335403	485	379091	PH130-0038	405
329103	REC329103	475-479	335404	REC335404	485	379312	REC387262	398
329319	REC0329319	436	335419	REC335419	481			

RO/OEM	REF		RO/OEM	REF		RO/OEM	REF	
379312	REC396522	398	390821	SOL2532-140-19	546	396377	REC396377	473-474
379504	REC379504	519-520	390822	SOL2532-140-21	546	396379	REC396379	473-474
379818	PH130-0038	405	390823	SOL2532-140-23	546	396504	REC396504	473-474
380095	PH375-0012	410	390900	REC390900	469	396520	REC396520	398
380139	PH130-0038	405	391170	REC391170	473-474	396521	REC396521	398
380238	PH130-0038	405	391198	SOL2411-135-15	545	396522	REC396522	398
381864	PH130-0038	405	391198	SOL2413-130-15	545	396701	REC396701	397
382049	REC439071	396	391198	SOL2431-135-15	545	396725	REC396725	439
382343	REC382343	515-519	391200	SOL2511-148-17	546	396725	REC396725	519
382363	REC382363	397	391200	SOL2513-145-17	546	396750	REC396750	478
382407	REC382407	515-519-520-525-529	391200	SOL2531-143-17	546	396809	REC777214	439-517
382408	REC382408	519-520-525-531	391201	SOL2511-145-19	546	396987	REC396987	433
382547	REC765431	439-519	391201	SOL2513-143-19	546	397004	REC0397004	430
382761	SOL2411-140-11	545	391201	SOL2531-140-19	546	397023	PH130-0008	408
383052	REC439071	396	391202	SOL2511-143-21	546	397537	REC397537	515
383067	REC439071	396	391202	SOL2513-140-21	546	397538	REC397538	515
383622	PH375-0012	410	391202	SOL2531-140-21	546	397768	CM397768	456
383691	PH130-0043	406	391203	SOL2511-142-23	546	397768	CM397768A	456
384087	REC384087	446-517	391203	SOL2531-140-23	546	397768	TEN00907BIS	460
384163	PH130-0045	406	391264	PH200-T014	423	397768	TEN00928	460
384195	REC384195	523	391290	SOL2531-143-17	546	397768	TEN00928AL	460
384461	REC0385008	417	391300	REC439085	478	397839	REC1399-07350	392
384777	PH130-0043	406	391305	REC439072	396	398042	REC398042	525-529-551
384799	PH130-0008	408	391416	REC391416	473-474	398047	REC39390	477
385008	REC0385008	417	391511	PH130-0008	408	398051	REC398051	467
385043	REC385043	519-520	391535	SOL2511-150-15	546	398126	SOL2111-093-07	545
385068	REC385068	519	391535	SOL2513-148-15	546	398172	REC398172	478
385072	REC385072	439	391535	SOL2531-145-15	546	398243	REC0398243	430
385087	REC385087	519	391554	PH130-0044	407	398319	REC40135	389
385175	REC31-32575T1	517	391668	SOL2411-138-13	545	398327	REC40135	389
385389	PH375-0027	410	391668	SOL2413-133-13	545	398331	CM433458	455
385401	PH130-0038	405	391735	PH130-0043	406	398331	CM433458A	455
385416	REC439084	477	391741	REC391741	450	398331	TEN00910	461
385503	REC31-02803	470	391988	REC391988	479	398452	REC439072	396
385528	REC777212	531	392061	REC396701	397	398453	REC439072	396
385529	PH130-0044	407	392123	CM392123	456	398514	REC398514	393
385818	TEN00902	459	392123	CM392123A	456	398526	REC439076	397
386084	REC386084	439-510	392123	TEN00908	460	398529	REC398529	469
386279	REC386918	473	392133	PH130-0038	405	398532	REC439071	396
386280	REC386280	473	392462	CM392462	455-517	398693	REC398693	479
386430	PH130-0014	405	392462	CM392462A	455	398729	REC396701	397
386465	PH130-0044	407	392462	TEN00909	461	398873	CM398873	455-515
386545	MP39100		392550	REC439076	397	398873	CM398873A	455-515
386573	REC386573	488	392567	REC802133	477	398873	TEN00915	461
386591	PH130-0038	405	392615	REC802133	477	398874	REC398874	515
386597	PH130-0038	405	393023	CM393023	455	398901	REC398901	515
386657	PH130-0043	406	393023	CM393023A	455	431708	CM431708	455-519-520-525-529
386764	REC386764	515-517	393023	TEN00907	460	431708	CM431708A	455
386765	REC386765	515-517	393023	TEN00907AL	460	431708	TEN00917	460
386766	REC386766		393088	REC393088	393	431870	REC431870	474
386866	REC386866	551	393103	REC393103	394	431930	SOL2532-143-17	546
386909	SOL2311-125-13	545	393259	PH200-T014	423	432264	REC432264	515
387041	REC5007190	469	393301	MP39760	409	432276	REC432276	515
387094	PH130-0039	407	393433	REC439083	477	432397	CM334451	455
387139	REC764102	469	393561	REC393561	483	432397	CM334451A	455
387247	REC387247	525-531	393570	PH130-0012	407	432397	TEN00913	460
387262	REC387262	398	393630	REC393630	450-513	432570	REC432570	478
387277	PH200-T020	423	393632	REC393632	446-513	432571	REC436891	479
387361	REC763735	439	393896	REC31-02799	469	432925	PH130-0018	407
387656	REC387656	523-527-529-531	393988	PH200-T014	423	432941	REC432941	439-515
387684	PH130-0045	406	394176	PH200-T014	423	432955	REC432955	451
387787	REC387787	469	394408	REC394408	438	432962	REC432962	394
387817	REC387817	527-529-531	394411	REC394411	433	433190	REC433190	389
388344	REC388344	469	394462	REC394462	466	433226	PH200-T022	424
389039	REC389039	525-529	394488	REC5004705	466	433325	REC0433325	430
389042	REC389042	525-529	394546	REC802113	477	433458	CM433458	455
389133	REC389133	451	394711	REC394711	449	433458	CM433458A	455
389275	PH130-0045	406	394885	REC434381	478	433458	TEN00910	461
389380	PH130-0044	407	394930	REC394930	473-474	433550	REC433550	541
389398	PH375-0012	410	395073	REC395073	452	433570	REC433570	517
389455	REC389455	525	395204	REC0395204	412	433580	CM433580	
389493	PH375-0012	410	395207	PH130-0039	407	433580	CM433580A	
389510	SOL2431-130-19	545	395209	REC395209	525-538	433580	TEN00918	460
389512	SOL2431-130-21	545	395270	REC395270	450	433580	TEN00918AL	460
389556	REC439085	478	395289	REC395289	439-511-513	433935	REC0767407	439
389577	REC389577	445-509	395391	REC0395204	412	433941	REC802133	477
389589	REC777129	439	395401	REC395401	469	434029	CM434029	456
389642	REC777212	439	395419	PH375-0012	410	434029	TEN00914	461
389923	SOL2531-140-21	546	395460	REC93-08668	408	434029	TEN00914/1	461
389924	SOL2531-140-19	546	395627	REC395627	468	434137	REC434137	433
389948	SOL2431-133-17	545	395780	TEN00911	460	434153	REC414153	551
389949	SOL2431-135-15	545	395780	TEN00911AL	460	434381	REC434381	478
389954	PH130-0044	407	395861	REC395861	466	434391	REC434391	519
389999	CM389999	455	395911	REC0395911	430	434424	REC434424	439
389999	CM389999A	455	396041	REC878763	469	434467	REC434467	525
389999	TEN00929	459	396077	REC0586695	416	434495	PH200-T005	424
390078	REC439084	477	396141	REC0586697	416	434496	PH200-T005	424
390286	REC390286	439	396235	PH130-0008	408	434588	REC434588	515
390509	REC390509	473	396350	REC396350	541	434839	REC434839	391
390510	REC390510	473	396351	REC396351	513-541	434841	REC6F5-12411-03	433-435
390613	REC390613	445	396352	REC396352	542	434844	REC434844	468
390641	REC31-02806	470	396355	REC396355	541	434888	REC439076	397

RO/OEM	REF	RO/OEM	REF	RO/OEM	REF			
435027	REC435027	523	581295	REC3857533	410	583410	REC0763769	419
435123	REC435123	525-532	581397	REC0764708	417	583415	REC0763765	419
435230	REC0435230	430	581407	REC0502880	400	583471	REC0584035	414
435274	REC435274	515	581419	REC0581419	426-427	583476	REC0586667	414
435279	REC0435279	492	581528	PH375-0033	410	583482	PH130-0016	406
435390	REC435390	446-510	581528	REC581528	410	583485	REC0584333	418
435442	REC438996	396	581651	REC0763770	419	583489	REC0584041	414
435443	REC439076	397	581670	REC5000611	418	583512	REC0763791	413
435491	REC435491	433-435	581726	REC581726	417	583529	REC0585195	413
435519	REC435519	519	581731	REC0582056	417	583533	REC763775	418
435532	PH200-T021	424	581778	PH350-0002	414	583536	REC0763767	419
435548	REC435548	425	581786	REC0502881	400	583561	REC0584288	419
435676	REC439078	396	581805	REC0582125	416	583604	REC0586697	416
435678	REC439078	396	581957	REC0583724	418	583644	REC0583724	418
435752	REC439078	396	581987	REC0583672	419	583663	REC300-26084	417
435821	REC5001593	452-523	582016	REC0583672	419	583667	REC300-26084	417
435957	REC435957	432	582047	PH200-T020	423	583668	REC0583668	419
435959	REC435990	529	582048	PH200-T020	423	583670	REC0583670	418
435959	REC5007968	446	582056	REC0582056	417	583671	REC0583672	419
435959	REC5007968	523-527-531	582057	REC0582057	417	583672	REC0583672	419
435990	REC435990	446-523-527	582091	REC0502888	400	583689	REC0583689	413
436137	REC389576	509	582115	REC0582115	416	583710	REC0763764	419
436195	REC878904	432-433	582125	REC0582125	416	583724	REC0583724	418
436254	REC436254	474	582138	REC0582642	416	583737	REC584561	400
436353	REC436353	474	582155	PH200-T020	423	583740	REC0583740	400
436358	REC436358	477	582160	REC0502890	400	583748	REC0583748	416
436367	REC0436367	415	582261	REC0586695	416	583773	REC0584028	415
436745	REC436745AL	517-519-520-525-529	582262	REC0582262	415	583777	REC584030	415
436745	TEN00907	460	582281	REC0586697	416	583865	REC0583865	414
436745	TEN00907AL	460	582285	REC0586697	416	583896	REC300-26085	417
436888	REC436888	538	582366	REC584561	400	584027	REC0584028	415
436891	REC436891	479	582399	PH350-0001	414	584028	REC0584028	415
436972	REC436972	474	582400	REC0582642	416	584029	REC584030	415
437088	REC31-17514A2	469	582453	REC0582452	416	584030	REC584030	415
437090	REC437090	433-435	582454	REC0582125	416	584034	REC0584035	414
437155	REC437155	479	582472	REC3857533	410	584035	REC0584035	414
437288	REC437288	513	582473	REC3857533	410	584036	REC0586667	414
437330	REC437330	523-527-529	582474	REC0582901	416	584037	REC0586667	414
437725	REC437725	479	582497	REC0583672	419	584040	REC0584041	414
437801	PH200-T021	424	582502	REC0586697	416	584041	REC0584041	414
437909	REC437907	450	582504	REC0586695	416	584107	PH200-T020	423
438048	REC5007022	493	582506	REC0583724	418	584109	REC0763759	419
438529	PH200-T005	424	582508	REC0582508	400	584122	REC0436367	415
438531	PH200-T005	424	582514	REC0763776	418	584128	PH375-0029	409
438543	REC438543	446-519	582556	REC0582642	416	584204	REC0585195	413
438544	REC438544	515	582574	REC0583668	419	584205	REC0763791	413
438545	REC438545	515	582642	REC0582642	416	584265	REC0586343	417
438555	REC1399-07353	392	582684	REC0582125	416	584287	REC0583415	419
438556	REC1399-07352	393	582705	REC0763793	415	584287	REC0763765	419
438559	REC438559	393	582708	PH375-0012	410	584288	REC0584288	419
438562	REC1399-07351	392	582714	REC0586695	416	584292	REC0763764	419
438579	REC438579	451	582730	REC0583724	418	584329	REC300-26085	417
438592	REC438592	451	582757	REC0586697	416	584331	REC300-26085	417
438602	REC438602	450	582800	REC0586695	416	584333	REC0584333	418
438616	REC438616	394	582847	REC0583670	418	584416	REC3857533	410
438786	PH200-T004	425	582864	REC0582901	416	584477	REC0584477	400
438878	PH130-0032	407	582867	REC0583672	419	584488	REC300-26084	417
438904	REC39390	477	582880	REC0586697	416	584489	REC300-26085	417
438996	REC438996	396	582888	REC0502888	400	584504	REC5000611	418
439071	REC439071	396	582889	REC0586695	416	584508	REC0586695	416
439072	REC439072	396	582901	REC0582901	416	584528	REC0586695	416
439074	REC439075	397	582904	REC0395204	412	584560	REC0763763	419
439075	REC439075	397	583023	REC0583672	419	584561	REC584561	400
439076	REC439076	397	583041	REC0582262	415	584580	REC584580	409
439077	REC439077	452	583045	REC0763776	418	584586	REC763775	418
439078	REC439078	396	583050	REC0583668	419	584608	PH130-0013	405
439083	REC439083	477	583103	REC0582262	415	584632	REC0502890	400
439085	REC439085	478	583104	REC0583672	419	584636	REC0586661	414
439138	REC439138	515-538	583114	REC0583114	416	584637	REC0586661	414
439185	REC439185	519-538	583117	REC0583670	418	584641	REC0586271	413
439347	REC4428	393	583119	REC0583724	418	584642	REC0763803	414
439347	REC5004428	393	583122	REC0583320	416	584643	REC0763779	419
439476	REC439476	523-527-529-531	583125	REC0582115	416	584746	REC0586695	416
439542	REC0439542	430	583143	REC0582115	416	584755	REC0763770	419
439559	REC439559	478	583167	REC0586697	416	584767	REC5001344	416
439561	REC300-08010	413	583168	REC0586697	416	584768	REC5001344	416
439937	PH200-T004	425	583169	REC0586697	416	584783	REC0586798	415
439972	REC5007022	493-525	583170	REC0586697	416	584799	PH130-0008	408
439973	REC439973	493-525	583172	REC0586695	416	584804	REC0763773	418
502881	REC0502881	400	583174	REC0586695	416	584808	REC5004532	415
502890	REC0502890	400	583175	REC0586697	416	584818	PH130-0026	406
508180	MP39760	409	583241	REC0586695	416	584840	REC5000611	418
509219	PH350-0003	411	583266	REC0583689	413	584849	REC0763760	418
552906	REC328522	548	583274	REC0583668	419	584890	REC300-03588	412
553126	REC553126	445-515	583289	REC0763776	418	584908	REC5001344	416
554545	REC0554545	445-513	583320	REC0583320	416	584910	REC0584985	415
580148	REC0580148	427	583336	REC0582262	415	584912	REC0584986	414
580256	REC0580256	426-427	583340	REC0763767	419	584914	REC0586343	417
580290	REC0580290	427	583379	REC0763776	418	584954	REC0584954	418
580321	REC0580321	426-427	583380	REC0582452	416	584980	PH130-0027	407
581030	REC0583672	419	583387	REC0583387	417	584981	REC0763759	419
581207	REC0581207	427	583408	PH350-0001	414	584985	REC0584985	415

RO/OEM	REF	RO/OEM	REF	RO/OEM	REF			
584986	REC0584986	414	777699	REC581528	410	5000308	REC5000308	450
584988	REC0584986	414	777700	REC378444	410	5000309	REC5000309	541
584989	REC0584986	414	777702	REC3857533	410	5000400	REC5000400	478
584990	REC0584985	415	777784	PH200-T020	423	5000614	REC5000614	529-538
584991	REC0584986	414	778021	PH375-0030	410	5000615	REC5000615	523-527-538
585001	REC300-03587	412	778025	PH375-0029	409	5000618	REC5000618	538
585051	PH130-0044	407	778162	REC65L-24563-00	389	5000623	REC5000623	529-538
585056	PH130-0016	406	778209	PH375-0027	410	5000624	REC5000624	529-538
585057	PH130-0044	407	778417	REC340559	467	5000626	REC5000626	538
585058	PH130-0043	406	778885	REC16510-87J00	391	5000800	REC4428	393
585059	PH130-0017	406	778886	REC16510-90J00	391	5000800	REC5004428	393
585060	PH130-0012	407	778887	REC16510-82703	391	5001036	REC5001036	433
585061	PH130-0038	405	778888	REC16510-93J00	391	5001593	REC5001593	527-529
585062	PH130-0039	407	778991	PH130-0017	406	5001594	REC5001594	452
585063	PH130-0045	406	778992	PH130-0039	407	5001595	REC5001595	452
585073	REC5000611	418	778993	PH130-0045	406	5004218	REC5004218	532
585074	REC5001344	416	778994	PH130-0012	407	5004257	REC5004257	525
585081	REC0585081	412	778996	PH130-0026	406	5004428	REC4428	393
585087	REC0763770	419	892187	PH375-0029	409	5004428	REC5004428	393
585114	REC0586661	414	908034	REC35-53336	390	5004533	REC5004532	415
585134	MP28870	422	908158	REC908158	519-520-525-529	5004765	REC5004765	525-529-538
585145	REC5004532	415	908194	REC908194	445	5005034	REC5005034	551
585189	REC5004532	415	908383	REC908383	445	5005114	REC18-6865	425
585192	REC0763791	413	908855	REC908855	443	5005254	PH200-T004	425
585195	REC0585195	413	909047	REC326649	445	5005266	REC5007335	389
585196	PH130-0044	407	909140	REC909140	445	5005374	PH200-T005	424
585197	PH130-0043	406	909386	REC909386	517-519	5005383	SOL4111-093-08A	545
585261	REC0175316	415	910139	REC1397-2150	390	5005384	SOL4111-093-09A	545
585262	REC0175316	415	910994	REC5004218	525	5005385	SOL4111-093-10A	545
585274	REC0585274	415	911019	REC911019	443	5005440	REC6F5-12411-03	432-433
585995	REC0586271	413	911685	REC911685	443	5005801	REC5005801	409
586000	REC0583689	413	911961	REC911961	519-520	5005817	PH200-T061	425
586015	REC0765386	414	911962	REC911962	525-528	5005822	PH200-T072	424
586048	REC300-03586	413	913921	REC3852928	515	5005831	PH200-T072	424
586075	REC300-03585	413	914716	REC337774	533	5005838	PH200-T061	425
586098	REC0765386	414	915954	REC915954	520-525	5005875	PH200-T072	424
586147	REC3857533	410	916058	REC3853655	443	5005907	REC5005907	477
586180	PH375-0012	410	976669	CM976669	455	5005931	REC5005931	478
586212	REC0586661	414	976669	CM976669A	455	5006180	REC5006180	428
586217	REC0586667	414	976669	TEN00900	459	5006181	REC5006181	428
586224	REC3857533	410	979774	PH375-0030	410	5006182	REC5006182	429
586257	PH130-0032	407	980756	CM980756	456	5006184	REC5006184	429
586271	REC0586271	413	980756	CM980756A	456	5006186	REC5006186	429
586275	PH130-0013	405	980801	PH375-0027	410	5006241	REC5006241	523-527-529
586276	PH130-0014	405	981195	REC981195	443	5006319	PH200-T061	425
586277	PH130-0026	406	981196	REC981196	443	5006373	REC5006373	541
586278	PH130-0038	405	981268	REC981268	443	5006479	PH200-T072	424
586279	PH130-0016	406	981703	PH375-0027	410	5006655	REC435546	473
586280	PH130-0045	406	981911	REC981911	390	5006657	REC5006657	473
586281	PH130-0043	406	982189	PH375-0027	410	5006658	REC5006658	473
586282	PH130-0044	407	982230	REC982230	390	5006662	REC5006662	473
586283	PH130-0044	407	982277	CM982438	457	5006664	REC5006664	473
586284	PH130-0027	407	982277	TEN00901	459	5006665	REC5006665	473
586285	PH130-0012	407	982438	CM982438	457	5006666	REC5006666	474
586286	PH130-0018	407	982438	TEN00902	459	5006668	REC5006668	473
586287	PH130-0018	407	983019	PH200-T014	423	5006669	REC5006669	473
586288	PH130-0039	407	983446	REC435548	425	5006670	REC5006670	473
586289	PH130-0008	408	983494	CM983494	457	5006687	REC5006687	474
586292	REC0765386	414	983494	CM983494A	457	5006688	REC5006688	474
586343	REC0586343	417	983494	TEN00906	459	5006694	REC5006694	474
586411	PH130-0008	408	983870	REC1397-2150	390	5006701	REC5006701	474
586661	REC0586661	414	983952	CM984547	456	5006702	REC5006702	474
586667	REC0586667	414	983952	CM984547A	456	5006711	REC5006711	474
586730	PH375-0027	410	983952	TEN00904	459	5006713	REC5006713	474
586731	PH130-0008	408	984491	REC984491	390	5006714	REC5006714	474
586767	REC0586767	410	984513	CM984513	457	5006716	REC5006716	474
586768	PH130-0035	405	984513	CM984513A	457	5006751	REC5006751	474
586774	REC586774	410	984513	TEN00903	459	5007089	CM5007089	456
586842	PH375-0027	410	984547	CM984547	456	5007089	CM5007089A	456
586890	PH130-0008	408	984547	CM984547A	456	5007089	TEN00918	460
586897	PH130-0008	408	984547	TEN00916	459	5007089	TEN00918AL	460
586957	PH130-0008	408	985063	PH375-0029	409	5007129	REC5007129	479
587045	PH130-0035	405	985064	PH375-0027	410	5007326	REC5007326	389
678882	REC396521	398	985237	REC435548	425	5007850	REC5007850	477
763760	REC0763760	418	986158	TEN00919	459	5009214	REC586774	410
763763	REC0763763	419	987067	TEN00920	459	5030034	REC09116-06094	462-499-501-505-508
763764	REC0763764	419	987067	TEN00920	459	5030035	PAGB/T5783-M6X16	497
763765	REC0583415	419	3214722	REC321722	488	5030037	PAGB/T5787-M6X20	503
763765	REC0763765	419	3214794	REC321794	488	5030038	PAGB/T5783-M6X16	506
763767	REC0763767	419	3234323	REC0324323	482	5030051	PAGB/T6170-M6	497-499-501-505
763769	REC0763769	419	3343105	REC343105	438	5030051	PAGB/T6184-2000	503
763770	REC0763770	419	3438544	REC438544	445	5030068	PAGB/T848-6	503
763773	REC0763773	418	3852020	REC126870	549	5030068	PAGB/T93-6	499-505
763775	REC763775	418	3852056	REC3852056	548	5030071	REC09168-10022	489-497-499-501-503-505-506-507
763776	REC0763776	418	3852548	REC3852548	443	5030084	REC09202-04002	505-548
763779	REC0763779	419	3852565	REC25-25439	445	5030087	REC91490-30025	497-503-508-548
763785	REC0583668	419	3853818	TEN00903	459	5030087	REC91490-40030	501-505-506-507
765553	REC433190	389	3853930	TEN00919	459	5030094	REC09248-10008	497-499-501-503-505-506-507-540
765591	REC438559	393	3854061	TEN00920	459	5030107	REC09282-10008	489-497
772681	GS31083	384	3854130	TEN00922	459	5030108	REC09282-12008	489
777693	PH130-0039	407	4359073	REC439073	397	5030109	REC09283-10003	489
777699	PH375-0033	410	5000074	REC5000074	525			

RO/OEM	REF		RO/OEM	REF		RO/OEM	REF	
5030110	REC09283-20018	489	5031403	REC15710-87J00	395	5032801	REC56120-94321-OEP	505
5030111	REC09283-20045	489	5031411	REC16510-87J00	391	5032802	REC56130-94413-OEP	447-505
5030137	REC09420-03002	441-497	5031417	REC17461-96312	501-503-505	5032929	CM5032929	457
5030181	REC15170-98110	394	5031418	REC17471-94401	448-503-505	5032929	REC55125-90J01AL	506-507
5030183	REC16910-GB2-005	389	5031419	REC17472-96303	446	5032929	TEN00927	462
5030188	REC17461-98503	497	5031426	REC17616-87J00	463	5032930	CM5032930	456
5030189	REC17471-98601	448	5031426	REC17616-87J00	466	5032930	REC55125-90J01AL	507
5030190	REC17472-98611	449	5031430	REC17685-87D10	463	5032930	REC55321-90J01AL	506
5030215	REC25222-93901	539	5031449	REC23311-95D10	539	5032930	TEN00937	461
5030225	REC37830-89E03	422	5031456	REC25700-88L00	441-505	5032930	TEN00937AL	461
5030265	TEN00930	459	5031468	REC33220-76G02	399	5032945	PAGB/T820-M6X20	499
5030267	CM55320-98600	456	5031474	REC34801-99E04	425	5032950	REC09141-12005	548
5030267	TEN00932	461	5031481	REC37820-92E03	422	5032966	REC09160-20027	533
5030276	REC57311-98600	497-533	5031482	PH200-T062	424	5032967	REC09160-20042	499-533
5030277	REC57510-91J00	532	5031482	REC38100-87J00	424	5032968	REC09160-20043	499-533
5030278	REC57521-91J00	497-532	5031483	PH375-0047	411	5032969	REC09160-20044	499-533
5030282	REC57632-97L00	497-534	5031523	REC51211-87J00	463-465	5032970	REC09160-21009	499-533
5030338	PAGB/T5783-M6X12	507	5031535	REC55122-94400	449	5032985	REC09160-20041	499-533
5030352	REC17400-98652	449	5031536	CM55125-95500	457-505	5032987	REC09168-12017	391
5030356	REC32800-95D01	411	5031536	TEN00931	461	5032996	REC09204-02004	548
5030391	PAGB/T5283-M6X25	497	5031538	CM5031538	457	5033002	REC09263-15019	499-537
5030391	REC09116-06121	462-501-503	5031538	CM55300-95500	499-503-505	5033003	REC09263-20L04	499-533
5030394	PAGB/T5787-M6X30	501	5031538	TEN00935	461	5033009	REC09280-54001	391
5030398	PAGB/T5783-M8X25	507	5031546	REC57610-94402	505	5033010	REC09280-57002	499-540
5030405	PAGB/T818-M4X30	506	5031547	REC57621-94403	533	5033011	REC09282-12010	489
5030406	PAGB/T8.8-2000	507	5031548	REC57630-94300	505-550	5033014	REC09289-12003	499
5030409	PAGB/T818-M6X10	499	5031549	REC57631-95303	505-534	5033015	REC09289-17006	489-499
5030415	PAGB/T889.1-M4	506	5031619	SOL4311-116-13	545	5033027	REC09380-15001	447-499
5030422	REC90171-18M04	505-506-507-508	5031620	SOL4311-116-14	545	5033034	REC09440-05027	499-534
5030429	PAGB/T848-6	497-501	5031622	SOL4311-120-10	545	5033037	REC09440-32008	499-534
5030465	REC09168-12012	391	5031623	SOL4311-118-11	545	5033046	REC11141-93E20	464
5030508	REC93606-12019	507-508	5031624	SOL4311-116-12	545	5033070	REC12761-93E10	481
5030511	PAF25-00000014	507-508	5031705	CM5031705	455	5033086	REC13250-95D01	397
5030623	REC11265-87E10	462-463	5031705	CM55321-87J00	456	5033106	REC17400-93951	450-499
5030660	REC12761-72F00	481	5031705	CM55321-87J00	499	5033107	REC17411-93901	452-499
5030687	REC13650-56B00	399	5031705	REC57631-87J01AL	497	5033109	REC17450-93921	499
5030699	REC15170-99E00	394	5031705	TEN00925	460	5033110	REC17452-93910	449
5030700	REC63P-13907-03	393	5031705	TEN00925AL	460	5033111	REC17453-93901	499-540
5030702	REC15410-87J10	389	5031705	TEN00933	461	5033112	REC17461-93903	499
5030706	REC15440-99E01	391	5031731	REC17400-87E04	451-506	5033113	REC09420-03005	441
5030708	REC15710-99E00	395	5031744	REC17400-96403	451-503-505	5033113	REC17462-93990	441-499
5030723	REC17461-87E12	506	5031758	REC17670-94402	434	5033114	REC17471-93902	448-499
5030724	REC17471-92J00	448	5031822	PAGB/T5787-1986	497	5033167	CM5033167	456
5030725	REC17472-87E10	446-506-507	5031827	REC90179-08M06	501-503	5033167	REC55320-98400AL	499
5030742	REC17670-93962	434	5031863	REC09168-12017	391	5033167	TEN00936	461
5030742	REC17670-93962	434	5031880	REC09209-08016	501-503-534	5033185	CM55321-93900	456
5030780	PH130-0079	409	5031883	REC09263-20046	501-503-537	5033185	REC55321-93900	499
5030783	REC89-825096T01	409	5031884	REC09263-20047	501-503-540	5033185	TEN00934	461
5030795	REC32800-92E20	412	5031885	REC09265-17002	501-503-538	5033188	REC57100-93902	499-538
5030828	REC38100-99E01-OEP	424	5031890	REC925093	503	5033190	REC57311-93910	499-533
5030829	REC38100-99E01-OEP	424	5031893	REC09289-20009	489-501-503	5033191	REC57510-93910	499-532
5030830	REC38100-99E01-OEP	424	5031990	REC17411-94421	445-503-505	5033192	REC57521-93910	499-532
5030852	REC43711-97E11	539	5032030	REC32800-89J00	412	5033193	REC57610-93901	499-538
5030870	REC48630-94900	426	5032058	REC43211-87J10	539	5033196	REC57631-93901	499-534
5030907	TEN00926	461	5032058	REC43211-94401	539	5033197	REC57632-94J00	499-548
5030907	TEN00926AL	461	5032091	REC55125-91L01AL	501	5033198	REC57633-93901	499-548
5030967	REC57630-94500	506	5032098	REC57311-96311	533	5033200	SOL4111-093-07A	545
5030973	REC25700-87E00	442	5032098	REC57311-96320	501-503	5033203	SOL4111-093-11A	545
5030976	REC57630-94500	550	5032099	REC57510-89J00	532	5033221	REC65720-98520	384
5031114	REC15626-99E00	394	5032100	REC57521-89J00	501-503-532	5033222	GS31035	384
5031116	REC34801-99E04	425	5032100	REC57521-96312	532	5033222	GS31036	384
5031166	REC38100-99E01-OEP	424	5032101	REC57610-96311	501-503	5033264	REC38860-76F01	409
5031175	REC17670-93962	434	5032102	REC57621-91L10	533	5033299	REC08110-60020	499-538
5031196	REC17471-98601	448	5032103	REC57631-96301	503-534	5033303	REC08110-60050	499-540
5031203	REC57510-91J00	532	5032107	SOL4211-105-11	545	5033322	SOL3413-138-15	546
5031215	PAGB/T5783-M8X16	503-505	5032108	SOL4211-103-12	545	5033323	SOL3413-138-17	546
5031216	PAGB/T5783-M8X30	499-503	5032109	SOL4211-101-13	545	5033323	SOL3451-139-17	546
5031232	REC09160-26015	505-533	5032110	SOL4211-100-14	545	5033324	SOL3413-138-19	546
5031245	REC09202-05022	534	5032150	GS31089	384	5033324	SOL3451-139-19	546
5031251	REC57634-88L00	505-534	5032150	REC65720-986L0	384	5033325	SOL3413-138-21	546
5031255	REC09263-22020	505-540	5032167	REC25700-95D01	441	5033325	SOL3451-139-21	546
5031256	REC09263-22L03	505-537	5032167	REC25700-95D01	503	5033326	SOL3451-139-23	546
5031257	REC09263-25025	505-541	5032170	REC57630-96300	501-503-550	5033327	SOL3451-139-17	546
5031258	REC09263-25062	505-541	5032191	REC55125-91J01AL	503	5033328	SOL3451-139-19	546
5031260	REC09280-08005	539	5032197	PH375-0048	411	5033329	SOL3451-139-21	546
5031261	REC09280-11005	539	5032238	REC15410-98500	389	5033330	SOL3451-139-23	546
5031263	REC09280-75001	501-505-540	5032295	REC08113-60060	501-503-540	5033339	REC09283-10009	489
5031264	REC09282-17005	489-505	5032323	REC15410-87J10	389	5033342	REC11141-91J10	464
5031266	REC09282-17009	489	5032424	REC13910-89J01	397	5033371	PAF4-0409000	392
5031270	REC09289-22007	489-505	5032428	REC11413-87J00	466	5033372	REC15170-91J00	394
5031281	REC09420-04006	441-501-503-505	5032502	REC09116-06121	462	5033381	REC17472-91J00	449-497
5031286	REC09440-40002	505-534	5032615	REC32800-87J10	412	5033385	REC17670-91J01	434
5031293	REC11141-87J02	463-464	5032617	REC63P-13907-03	393	5033481	REC09283-25076	489
5031297	REC11189-87J00	463-465	5032670	PH200-T046	424	5033539	REC16510-90J00	391
5031302	REC11400-87804	465	5032670	PH200-T062	424	5033541	REC17400-90J20	451-507
5031302	REC11400-87804	465	5032689	REC57510-89J00	501	5033542	REC17461-90J01	507-508
5031304	REC11413-87J00	463-466	5032693	REC15710-66D00	395	5033632	REC09420-05009	441
5031306	REC11433-87J00	463-466	5032698	REC57510-89J00	503-532	5033639	REC11141-90J01	464
5031307	REC11489-87J00	463-484	5032732	REC33410-94400-000	400	5033649	REC11489-90J00	484
5031390	REC13421-87J00	463-466	5032743	REC56120-93900	499-540	5033702	REC63P-13907-03	393
5031392	REC13650-52G00	399	5032766	PAGB/T5783-M8X55	499	5033704	REC15440-90J00	391
5031400	REC15410-87J00	390	5032786	REC33220-76G02	399	5033706	REC15626-90J00	394

RO/OEM	REF		RO/OEM	REF	
5033708	REC15710-65D00	395	5036637	REC32800-93J03	413
5033722	REC17670-90J10	434	5036681	REC17472-96303	446-463-501-503-505
5033722	REC67F-12411-01	434	5036691	PAGB/T5783-M6X14	462-497
5033780	REC18590-72F21	399	5036701	REC38410-93J12	425
5033798	REC25700-90J01	442-507	5036714	REC11400-87804	465
5033799	PH130-0071	407	5036802	REC11141-95J00	464
5033820	REC32800-90J00	412	5036852	REC13122-95J00	487
5033838	REC38100-96J00	424	5036900	REC17413-95J00	448-501
5033919	REC16510-82703	391	5036901	REC17416-95J00	448-501
5033922	REC25700-92J00	442-507	5036902	REC17471-95J01	448-501
5033935	REC48630-92J00	426	5036908	REC17400-95J02	451-501
5033955	SOL3452-139-17	546	5036914	REC17693-95J00	487
5033956	SOL3452-139-19	546	5036938	REC09282-15008	489
5033957	SOL3452-139-21	546	5036972	PH130-0077	406
5034203	REC57510-91J00	497-532	5037038	REC25700-95J00	441-501
5034255	REC32800-94620	411	5037170	REC17471-92J00	448-507
5034323	REC17400-98661	449-497	5037175	REC17417-92J00	448
5034345	SOL4011-079-07S	497	5037176	REC17400-92J00	450
5034353	REC11141-87J02	464	5037205	REC51211-90J2	465
5034354	REC11400-87804	465	5037356	REC59178-97J00	540
5034354	REC11400-87804	465	5037363	PAGB/T91-1.6X12	548
5034462	REC11489-93E11	484	5037373	PAGB/T91-1.6X12	548
5034526	REC38100-96J00	424	5037431	REC17471-97J00	448
5034606	REC38410-93J12	425	5037432	REC17472-97J00	448
5034616	TEN00926	461	5037490	REC11141-97J02	464
5034616	TEN00926AL	461	5037515	REC57621-91L10	533
5034627	REC38100-96J00	424	5037518	PAF4-04090000	392
5034644	REC11141-92J01	464	5037545	REC17400-94J00	450
5034651	REC17471-92J00	448	5037584	REC15170-94J00	394
5034651	REC17471-92J00	506	5040140	PAF4-05000300	389
5034680	REC32800-89J11	412	5040343	PH130-0061	405
5034711	REC56120-96332-OEP	501-503-540	5040786	PH130-0006	405
5034757	REC51211-90J10	465	5084842	REC09420-05009	441
5034776	REC25700-99E00	441-506	5583473	PH130-0017	406
5034799	REC09168-10034	508-540	5814014	REC0582262	415
5034842	REC09420-05009	441	5844241	REC0583689	413
5034842	REC09420-05009	507-508	50030396	PAGB/T5787-M6X20	499
5034878	REC11489-93J00	484	50317562	REC17670-87J00	434
5034916	REC12778-93J00	487	50367173	REC17413-92J01	448
5034959	REC13119-93J00	486	0586767	REC0586767	410
5034978	REC14151-93J00	482	09141-		
5034979	REC14152-93J00	482	18005	REC90171-18M04	548
5034982	REC14212-93J00	482	176445		
5034984	REC15410-93J00	389	0775641	GS31085	384
5034985	REC15440-93J00	390	22-34982	GS31067	388
5034995	REC69J-24501-10	391	22-89771Q2	GS31066	388
5035010	REC15710-93J00	396	25222-		
5035022	REC16433-93J00	487	96300	REC25222-96300	539
5035036	REC17400-93J01	451	319771	REC386573	488
5035036	REC17400-96J03	508	320775-6	REC320775	517
5035038	REC17413-96J01	508	339543	REC339543	445
5035039	REC17416-93J00	448	387142	REC764102	469
5035039	REC17416-96J00	508	389576	REC389576	439
5035041	REC17471-92J02	448-508	436137		
5035042	REC17472-93J00	449-508	435821	REC5001593	439
5035054	REC17913-93J00	439	5001593		
5035055	REC17914-93J00	439	48-815083	SOL0001-073-06P	545
5035077	REC25700-93J00	442-508	5005440	REC6F5-12411-03	433
5035078	PH130-0078	408	500581	REC0500581	430
5035099	REC34801-93J03	425	396161	REC0500581	430
5035113	REC38100-96J00	424	5032047	REC37830-89E03	422
5035133	REC51123-93J00	487	5032195	PH375-0047	411
5035135	REC51142-93J00	465	5033102, 7	REC16510-05240	391
5035138	REC51211-93J00	465	5034775	REC25700-87E00	441
5035150	REC55125-90J01AL	508	5036040	REC25700-95D01	441
5035151	REC55128-93J10	508-540	5036629	REC11141-93J10	464
5035305	REC09280-22019	462	5035971	REC11141-93J10	464
5035412	REC18137-52D00	399	5036629	REC11142-93J10	464
5035460	REC57630-92E00	508-550	5035971	REC11142-93J10	464
5035513	REC38100-96J00	424	84-		
5035603	REC17472-93911	449-499	813715A1	REC15-203	404
5035609	REC17453-93901	540	84-		
5035695	REC65L-24563-00	389	819514T26	PH200-WH01	423
5035703	REC16510-93J00	391	84-		
5035786	REC55320-9511AL	508	826075A2	PH200-WH01	423
5035786	TEN00930	459	84-		
5035971	REC11142-93J10	464	826802A4	PH200-WH01	423
5035974	REC15410-87J30	389	89876A3	REC25000	385
5036016	REC57510-89J00	532	8M0097838	RAC320R-RAC-01	386
5036054	REC34801-99E04	425	8M0097838	RAC320R-RAC-03	386
5036059	REC57621-94403	505-533	90890-		
5036081	PH200-T062	424	06820	REC90890-06820	495
5036107	REC32800-38F10	412	91-31229	REC91-31229	494
5036191	REC13200-91J70	396	91-31229A7	RM91-31229A7	494
5036192	REC13200-91J70	396	91-34569A1	REC91-34569A1	494
5036226	REC17670-94J01	434	91-36569T	REC91-36569T	494
5036261	REC32800-94J11	411	91-		
5036277	REC34801-93J03	425	61067A04	REC91-61067A04	495
5036549	REC13200-91J70	396	91-61069T	REC91-61069T	495
5036618	REC32800-90J00	412	91-		
5036629	REC11141-93J10	464	821887T1	REC91-859046Q4	495
5036635	REC63P-13907-03	393	91-83164M	REC90890-06820	495
			91-859046Q	REC91-859046Q3	495
			91-		
			895343T01	REC91-895343T02	495
			91-		
			895343T02	REC91-895343T02	495